



## **Cisco Firepower 9300 Hardware Installation Guide**

**First Published:** 2015-07-16

**Last Modified:** 2022-12-01

### **Americas Headquarters**

Cisco Systems, Inc.  
170 West Tasman Drive  
San Jose, CA 95134-1706  
USA  
<http://www.cisco.com>  
Tel: 408 526-4000  
800 553-NETS (6387)  
Fax: 408 527-0883

THE SPECIFICATIONS AND INFORMATION REGARDING THE PRODUCTS IN THIS MANUAL ARE SUBJECT TO CHANGE WITHOUT NOTICE. ALL STATEMENTS, INFORMATION, AND RECOMMENDATIONS IN THIS MANUAL ARE BELIEVED TO BE ACCURATE BUT ARE PRESENTED WITHOUT WARRANTY OF ANY KIND, EXPRESS OR IMPLIED. USERS MUST TAKE FULL RESPONSIBILITY FOR THEIR APPLICATION OF ANY PRODUCTS.

THE SOFTWARE LICENSE AND LIMITED WARRANTY FOR THE ACCOMPANYING PRODUCT ARE SET FORTH IN THE INFORMATION PACKET THAT SHIPPED WITH THE PRODUCT AND ARE INCORPORATED HEREIN BY THIS REFERENCE. IF YOU ARE UNABLE TO LOCATE THE SOFTWARE LICENSE OR LIMITED WARRANTY, CONTACT YOUR CISCO REPRESENTATIVE FOR A COPY.

The Cisco implementation of TCP header compression is an adaptation of a program developed by the University of California, Berkeley (UCB) as part of UCB's public domain version of the UNIX operating system. All rights reserved. Copyright © 1981, Regents of the University of California.

NOTWITHSTANDING ANY OTHER WARRANTY HEREIN, ALL DOCUMENT FILES AND SOFTWARE OF THESE SUPPLIERS ARE PROVIDED "AS IS" WITH ALL FAULTS. CISCO AND THE ABOVE-NAMED SUPPLIERS DISCLAIM ALL WARRANTIES, EXPRESSED OR IMPLIED, INCLUDING, WITHOUT LIMITATION, THOSE OF MERCHANTABILITY, FITNESS FOR A PARTICULAR PURPOSE AND NON-INFRINGEMENT OR ARISING FROM A COURSE OF DEALING, USAGE, OR TRADE PRACTICE.

IN NO EVENT SHALL CISCO OR ITS SUPPLIERS BE LIABLE FOR ANY INDIRECT, SPECIAL, CONSEQUENTIAL, OR INCIDENTAL DAMAGES, INCLUDING, WITHOUT LIMITATION, LOST PROFITS OR LOSS OR DAMAGE TO DATA ARISING OUT OF THE USE OR INABILITY TO USE THIS MANUAL, EVEN IF CISCO OR ITS SUPPLIERS HAVE BEEN ADVISED OF THE POSSIBILITY OF SUCH DAMAGES.

Any Internet Protocol (IP) addresses and phone numbers used in this document are not intended to be actual addresses and phone numbers. Any examples, command display output, network topology diagrams, and other figures included in the document are shown for illustrative purposes only. Any use of actual IP addresses or phone numbers in illustrative content is unintentional and coincidental.

All printed copies and duplicate soft copies of this document are considered uncontrolled. See the current online version for the latest version.

Cisco has more than 200 offices worldwide. Addresses and phone numbers are listed on the Cisco website at [www.cisco.com/go/offices](http://www.cisco.com/go/offices).

The documentation set for this product strives to use bias-free language. For purposes of this documentation set, bias-free is defined as language that does not imply discrimination based on age, disability, gender, racial identity, ethnic identity, sexual orientation, socioeconomic status, and intersectionality. Exceptions may be present in the documentation due to language that is hardcoded in the user interfaces of the product software, language used based on standards documentation, or language that is used by a referenced third-party product.

Cisco and the Cisco logo are trademarks or registered trademarks of Cisco and/or its affiliates in the U.S. and other countries. To view a list of Cisco trademarks, go to this URL: <https://www.cisco.com/c/en/us/about/legal/trademarks.html>. Third-party trademarks mentioned are the property of their respective owners. The use of the word partner does not imply a partnership relationship between Cisco and any other company. (1721R)

© 2015-2022 Cisco Systems, Inc. All rights reserved.



# CONTENTS

---

## CHAPTER 1

### Overview 1

Features	1
Chassis Components	4
Deployment Options	6
Package Contents	6
Serial Number Location	8
Front Panel	9
Rear Panel	10
Supervisor	11
Security Modules	13
Network Modules	16
10-Gb Network Module	16
40-Gb Network Module	17
100-Gb Network Module	18
100-Gb Network Module	20
100-Gb Network Module (Double Wide)	21
Hardware Bypass Network Modules	21
40-Gb Network Module with Hardware Bypass	22
10-Gb SR/10-Gb LR Network Module with Hardware Bypass	24
Power Supply Modules	26
Fan Modules	28
Supported SFP/SFP+ and QSFP Transceivers	28
Hardware Specifications	31
Product ID Numbers	33
Power Cord Specifications	36

---

<b>CHAPTER 2</b>	<b>Installation Preparation</b>	<b>43</b>
	General Safety Warnings	43
	Safety Recommendations	46
	Maintain Safety with Electricity	46
	Prevent ESD Damage	46
	Site Environment	47
	Site Considerations	47
	Power Supply Considerations	47
	Rack Configuration Considerations	48

---

<b>CHAPTER 3</b>	<b>Rack-Mount and Ground the Chassis</b>	<b>49</b>
	Unpack and Inspect the Chassis	49
	Rack-Mount the Chassis	50
	Ground the Chassis	55

---

<b>CHAPTER 4</b>	<b>Installation, Maintenance, and Upgrade</b>	<b>59</b>
	Remove and Replace the Supervisor	59
	Install, Remove, and Replace the Security Module	61
	Remove and Replace the SSD	64
	Install, Remove, and Replace the Single-Wide Network Module	66
	Install, Remove, and Replace the Double-Wide Network Module	71
	Remove and Replace the Power Supply Module	75
	Connect the DC Power Supply Module	80
	Connect the HVDC Power Supply Module	83
	Remove and Replace the Fan Module	87
	Install the FIPS Opacity Shield	90



# CHAPTER 1

## Overview

---

- [Features, on page 1](#)
- [Chassis Components, on page 4](#)
- [Deployment Options, on page 6](#)
- [Package Contents, on page 6](#)
- [Serial Number Location, on page 8](#)
- [Front Panel, on page 9](#)
- [Rear Panel, on page 10](#)
- [Supervisor, on page 11](#)
- [Security Modules, on page 13](#)
- [Network Modules, on page 16](#)
- [Hardware Bypass Network Modules, on page 21](#)
- [Power Supply Modules, on page 26](#)
- [Fan Modules, on page 28](#)
- [Supported SFP/SFP+ and QSFP Transceivers, on page 28](#)
- [Hardware Specifications, on page 31](#)
- [Product ID Numbers, on page 33](#)
- [Power Cord Specifications, on page 36](#)

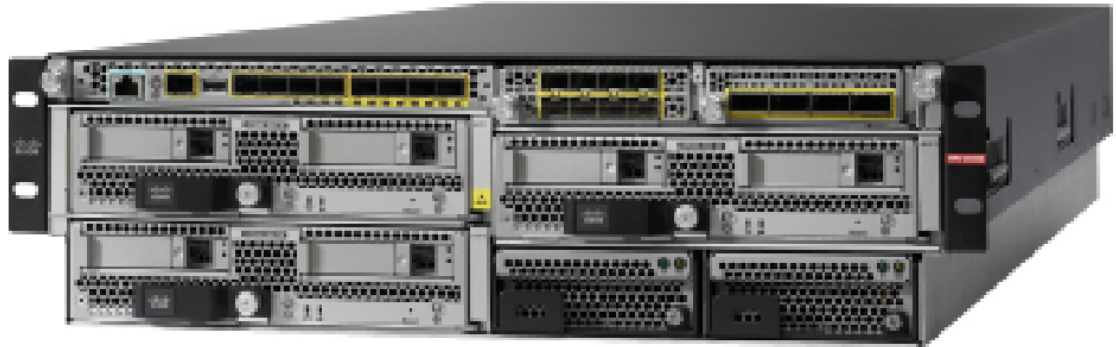
## Features

The Cisco Firepower 9300 security appliance is a next generation network and content security platform. Its modular standalone chassis offers high-performance and flexible I/O options, which enable it to run multiple security services simultaneously.

The Firepower 9300 runs FXOS and can deploy multiple application types. See [Cisco Firepower 4100/9300 FXOS Compatibility](#) for more information about software version support for each component in the Firepower 9300. See [Product ID Numbers, on page 33](#) for a list of the component product IDs (PIDs) associated with the Firepower 9300.

The following figure shows a fully populated Firepower 9300.

Figure 1: Firepower 9300



The following table lists the hardware features of the Firepower 9300.

Table 1: Firepower 9300 Features

Feature	Description
Security standards certifications	<ul style="list-style-type: none"> <li>• Common Criteria (CC) certification for the Network Device Collaborative Protection Profile (NDcPPv2.2E), VPN Gateway Module (VPNGW_MOD_v1.1), and Firewall Module (FW_MOD_v1.4e) for ASA 9.16.x.</li> <li>• Criteria Common Criteria Certification (CC) for the Network Device Collaborative Protection Profile (NDcPPv2.1) for FX-OS 2.6.x.</li> <li>• Federal Information Processing Standards (FIPS) 140-2 on ASA 9.12.x, FTD 6.4.x, and FX-OS 2.6.x.</li> </ul> <p><b>Note</b> See the "Security Certifications Compliance" chapter in the <a href="#">Cisco FXOS CLI Configuration Guide</a> or <a href="#">Cisco FXOS Firepower Chassis Manager Configuration Guide</a> for the procedure to enable security modes.</p>
Network Equipment Building Systems (NEBS) certification	<p>NEBS certification for the following security modules:</p> <ul style="list-style-type: none"> <li>• SM-24</li> <li>• SM-40</li> <li>• SM-44</li> <li>• SM-48</li> </ul>
Form factor	3 RU
Rack mount	Mount rails included (4-post EIA-310-D rack) with span between front and rear rails of 24 to 36 in.
Airflow	Front to rear Cold aisle to hot aisle

Feature	Description
Supervisor	<p>Cisco Firepower 9300 Supervisor with eight 10-Gigabit Ethernet ports and two network module slots for I/O expansion</p> <p>See <a href="#">Chassis Components, on page 4</a> for more information about the chassis Supervisor.</p>
Security module slots	Three
Supported security modules	<ul style="list-style-type: none"> <li>• SM-24—24-physical core CPU security module (NEBS ready)</li> <li>• SM-36—36-physical core CPU high performance security module</li> <li>• SM-40—40-physical core CPU Crypto security module (NEBS ready)</li> <li>• SM-44—44-physical core CPU high performance security module (NEBS ready)</li> <li>• SM-48—48-physical core CPU Crypto security module (NEBS ready)</li> <li>• SM-56—56-physical core CPU Crypto security module</li> </ul> <p>See <a href="#">Security Modules, on page 13</a> for more information about the security modules.</p> <p><b>Note</b> SM-24, SM-36, and SM-44 are not supported in Secure Firewall Threat Defense 7.3 and later or Secure Firewall ASA 9.19 and later.</p>
Network module slots	<p>Two</p> <p>Located in the Supervisor</p>
Supported network modules	<ul style="list-style-type: none"> <li>• 8-port 10-Gigabit Ethernet SFP+</li> <li>• 4-port 40-Gigabit Ethernet QSFP+</li> <li>• 2-port 100-Gigabit Ethernet QSFP28 (double-wide, occupies both network module slots)</li> <li>• 2-port 100-Gigabit Ethernet QSFP28</li> <li>• 4-port 100-Gigabit Ethernet QSFP28</li> <li>• 2-port 40-Gigabit Ethernet QSFP+ (built-in) with hardware bypass</li> <li>• 6-port 10-Gigabit Ethernet SR/LR fiber SFP+ (built-in) with hardware bypass</li> </ul> <p><b>Note</b> You can deploy the Firepower 9300 as a dedicated threat sensor with hardware bypass network modules.</p>
Memory	256-GB DDR4 DRAM per security module
Maximum number of interfaces	Up to twenty-four 10-Gigabit Ethernet (SFP+) interfaces; up to eight 40-Gigabit Ethernet (QSFP+) interfaces with two network modules; up to eight 100-Gigabit Ethernet (SFP+) interfaces

Feature	Description
Management port	One Gigabit Ethernet port on the Supervisor Supports 1-Gb fiber and copper SFPs
Serial port	One RJ-45 console
USB port	One USB 2.0 Type A
Pullout asset card	Displays serial number
Grounding lug	On rear panel
Locator beacon	On front panel
Power switch	On rear panel <b>Note</b> The initial Firepower 9300 chassis does not have a power switch.
Power supply slots	Two On rear panel
Power supply types	AC, DC, and HVDC <b>Note</b> Do not mix power supply types or wattage.
Redundant power	Yes 1 + 1
Fan slots	Four (hot-swappable) On rear panel
Storage	SM-24, SM-36, SM-44—Up to 2.4 TB per chassis (1.2 TB per security module in RAID 1 configuration) SM-40, SM-48, SM-56—UP to 4.8 TB per chassis (1.6 TB per security module in RAID 1 Configuration)

## Chassis Components

The Firepower 9300 chassis contains the following components:

- Firepower 9300 Supervisor—Chassis supervisor module
  - Management port
  - RJ-45 console port
  - USB Type A port
  - Eight ports for 1- or 10-Gigabit Ethernet small form-factor pluggable (SFP) ports (fiber and copper)
- Firepower 9300 Security Module—Up to three security modules



- Firepower Network Module—Two single-wide network modules or one double-wide network module
- Two power supply modules (AC or DC)
- Four fan modules

### Power Switch



---

**Note** The initial Firepower 9300 AC chassis has no external power switch. You reset the Firepower 9300 using CLI commands. To physically power cycle the 9300, you must unplug the power cord and then plug the power cord back in.

---



---

**Note** After removing power from the chassis either by moving the power switch to OFF or unplugging the power cord, wait at least 10 seconds before turning power back ON.

---

The Firepower 9300 chassis has a standby power switch at the rear of the chassis. It controls both power supply modules. You *must* shut down the software applications gracefully before turning the switch to OFF.



---

**Warning** Turning the switch to OFF turns off the main power to the Supervisor and the security modules regardless of the software status, which can result in the loss of any data in transit and the corruption of data on the SSDs. You must shut down the software applications gracefully before turning the switch to OFF.

---

### Graceful Shutdown of the Chassis

You can gracefully shut down the chassis from either the CLI or Chassis Manager.

See the "Powering Off the Firepower 4100/9300 Chassis" topic in the System Administration chapter in the [FXOS CLI Configuration Guide](#) for your software version for the procedure to shut down the chassis from the CLI. The graceful shutdown usually takes as little as a few seconds to as long as three minutes. When the `System Halted` message appears, you can move the power switch on the rear of the chassis to OFF.

See "Powering Off the Firepower 4100/9300 Chassis" topic in the System Administration chapter in the [FXOS Configuration Guide](#) for your software version for the procedure to shut down the chassis from the Chassis Manager. After the shutdown is completed, you can move the power switch on the rear of the chassis to OFF.

When you shut down the chassis, the security modules are automatically shut down.

### Graceful Shutdown of the Security Modules

You can shut down the security modules individually from the CLI, the Chassis Manager, or you can use the power switch on the front of each security module. Push the power button briefly on the front panel of each security module. When the power button changes to amber, you can move the power switch on the rear of the chassis to OFF.

Shut the security modules down individually when you are replacing a security module.



---

**Note** You *must* push the power button on each security module installed in the 9300 chassis. You can have up to three security modules installed in the chassis.

---

See the "Power Off/On an Installed Module/Engine" in the Security/Module/Engine Management chapter of the [FXOS CLI Configuration Guide](#) for your software version for the procedure to shut down the security modules gracefully using CLI commands from the Supervisor. When you see `Oper Power: off` for all slots, you can move the power switch on the rear of the chassis to OFF.

See the "Power Off/On an Installed Security Module/Engine" topic in the Security Module/Engine Management chapter of the [FXOS Configuration Guide](#) for your software version for the procedure to shut down the security module from the Chassis Manager. After the shutdown is complete, you can move the power switch on the rear of the chassis to OFF.

## Deployment Options

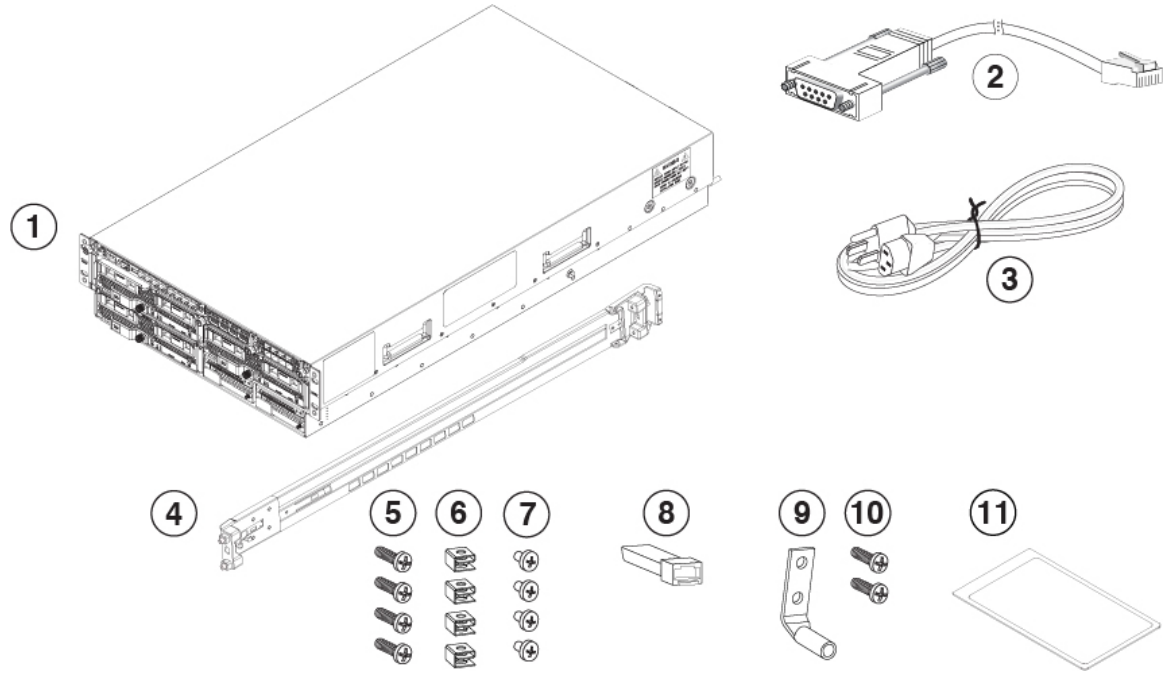
Here are some examples of how you can deploy the Firepower 9300:

- At the core/aggregation layer of a three-tier data center in a high availability configuration.
- As a dedicated multifunction security service within converged infrastructure stacks (vBlock, FlexPod, for example) at the access layer.
- As a high-performance data center security appliance between the WAN edge and data center core in an high availability configuration.
- As a leaf that exclusively offers security functions in a spine/leaf data center design.

## Package Contents

The following figure shows the package contents for the Firepower 9300. Note that the contents are subject to change and your exact contents might contain additional or fewer items.

Figure 2: Firepower 9300 Package Contents

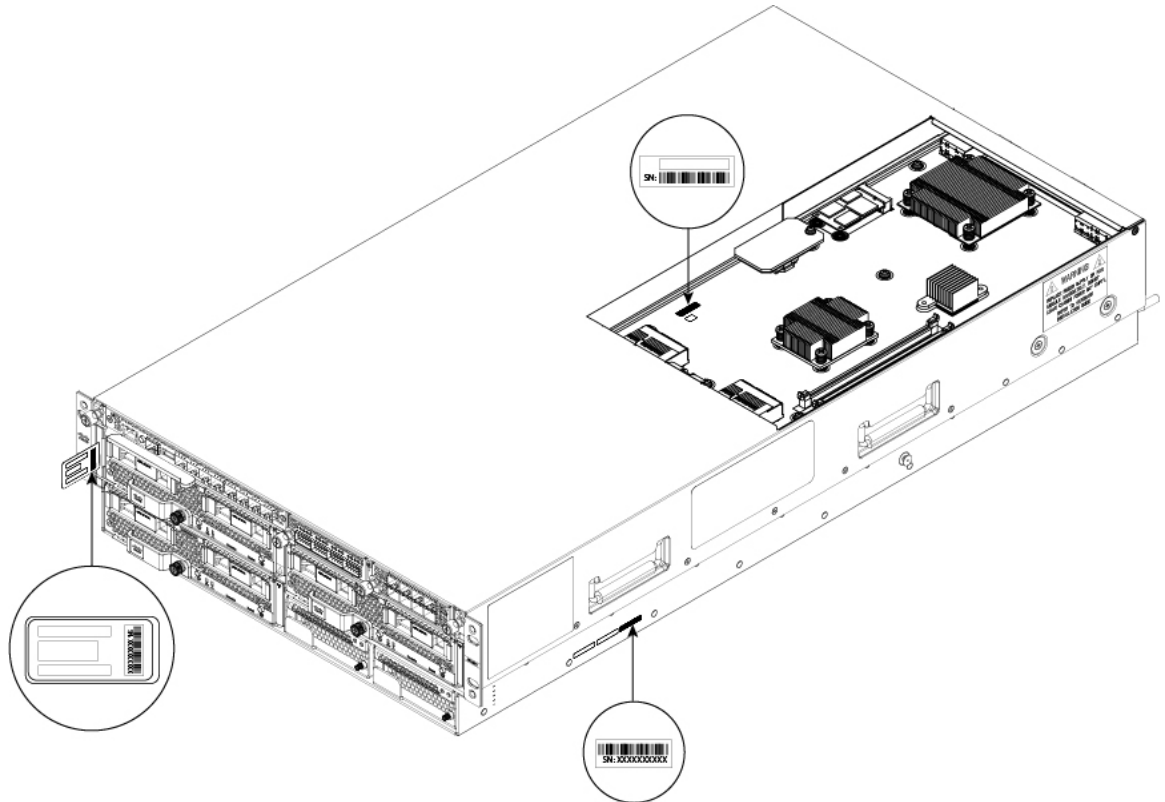


1	Firepower 9300 chassis	2	Blue console cable PC terminal adapter
3	Two power cords (country specific)	4	Two rack static rails Adjusts to fit racks with a 24 in. to 36 in. front-to-rear rail span
5	Four 10-32 x .5 inch screws used to attach the rails to rack	6	Four 10-32 retention nuts for rack-mounting
7	Four 10-32 x .75 inch Philips head screws used to attach the chassis to the rack	8	10/100/1000BASE-T SFP transceiver
9	One ground lug #6 AWG, 90 degree, #10 post <b>Note</b> The ground lug ships with the DC power version of the Firepower 9300.	10	Two 10-32 x .375 inch screws used to attach the ground lug
11	<i>Cisco Firepower 9300</i> This document has a URL and QR code that point to the Digital Documentation Portal. The portal contains links to the Product Information page, the Hardware Installation Guide, the Regulatory and Safety Information Guide, the Getting Started Guide, and the Easy Deployment Guide.		

# Serial Number Location

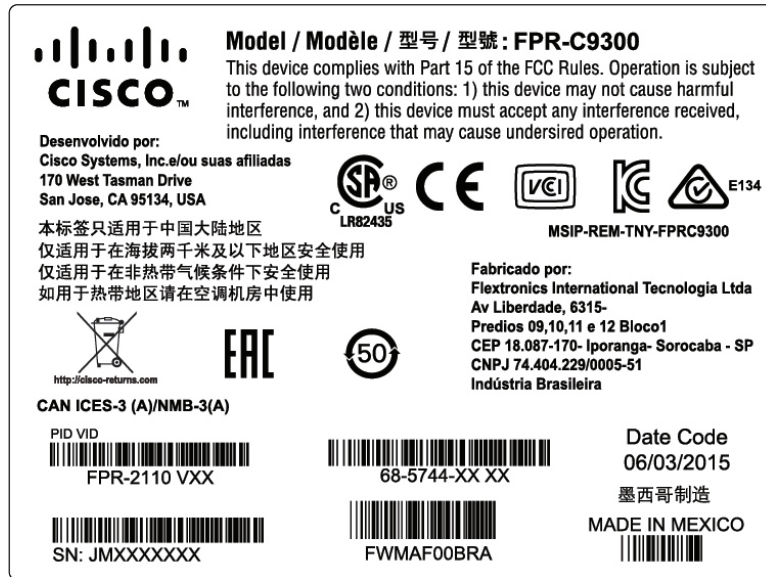
The serial number for the Firepower 9300 chassis is located on the pullout asset card on the front panel, on the side of the chassis, and on the Supervisor.

*Figure 3: Serial Numbers on the 9300 Chassis*



You can also view additional model information on the compliance label located on the bottom of the chassis.

Figure 4: Compliance Label on the 9300 Chassis



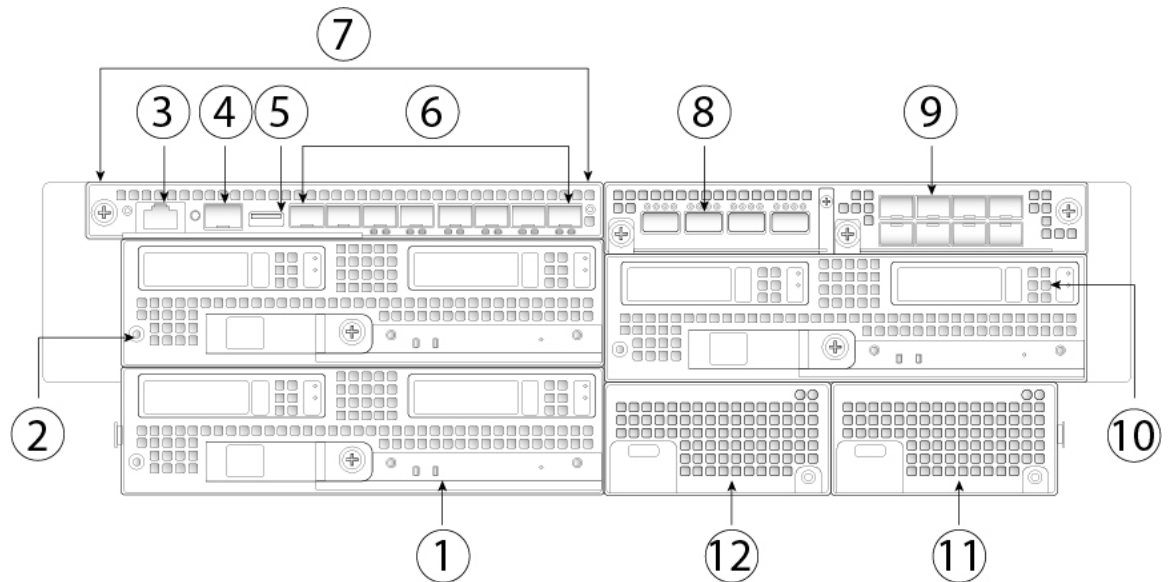
**For More Information**

For the procedure to remove the Supervisor so that you can see the serial number, see [Remove and Replace the Supervisor, on page 59](#).

# Front Panel

The following figure shows the front panel of the Firepower 9300.

Figure 5: Firepower 9300 Front Panel



1	Security module 3	2	Security module 1
3	RJ-45 console port	4	1 Gigabit Ethernet management port
5	2.0 USB port	6	Eight 10 Gigabit Ethernet data ports (Gigabit Ethernet 1/1 through 1/8)
7	Supervisor	8	Network module 1
9	Network module 2	10	Security module 2
11	Power supply module PSU-2	12	Power supply module PSU-1

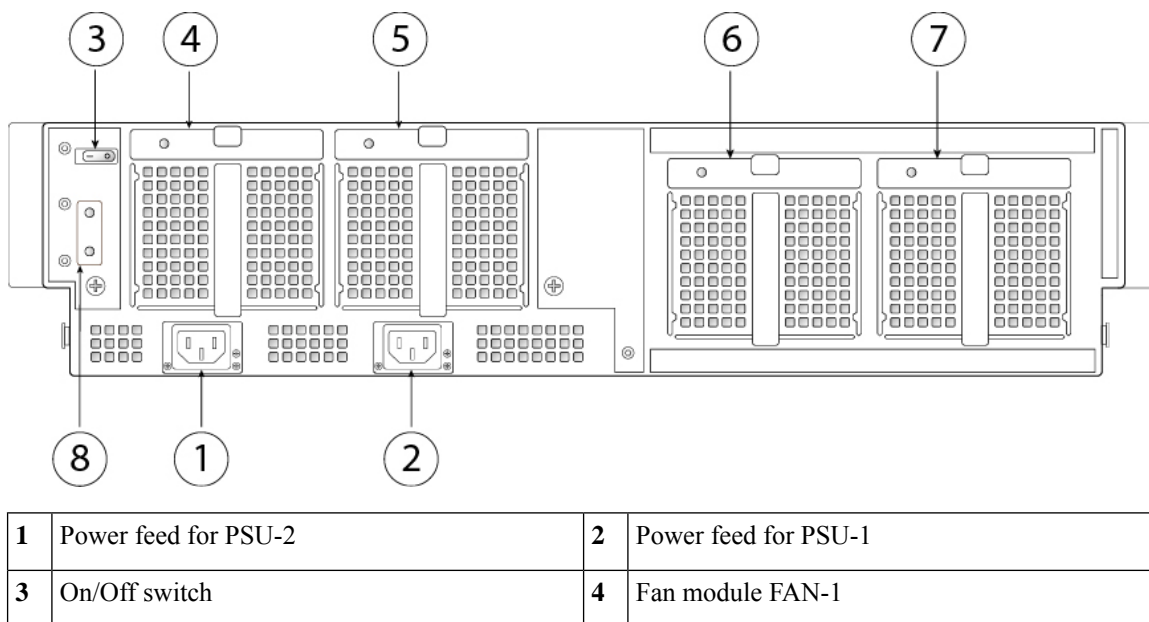
#### For More Information

- See [Chassis Components, on page 4](#) for a list of all of the chassis components.
- See [Supervisor, on page 11](#) for detailed information about the Supervisor.
- See [Security Modules, on page 13](#) for detailed information about the security modules.
- See [Network Modules, on page 16](#) for detailed information about the network modules.
- See [Hardware Bypass Network Modules, on page 21](#) for detailed information about hardware bypass network modules
- See [Power Supply Modules, on page 26](#) for detailed information about the power supply modules.

## Rear Panel

The following figure shows the rear panel of the Firepower 9300.

**Figure 6: Firepower 9300 Rear Panel**



5	Fan module FAN-2	6	Fan module FAN-3
7	Fan module FAN-4	8	Grounding lug

**For More Information**

- See [Chassis Components, on page 4](#) for detailed information about the power switch.
- See [Fan Modules, on page 28](#) for detailed information about the fan modules.
- See [Power Supply Modules, on page 26](#) for detailed information about the power supply modules.

# Supervisor

The Firepower 9300 contains a supervisor management I/O card called the Firepower 9300 Supervisor, which is located on the front panel. The Supervisor provides chassis management and eight 1- or 10-Gb SFP+ interfaces, and it directs traffic to/from the Firepower 9300 security modules.

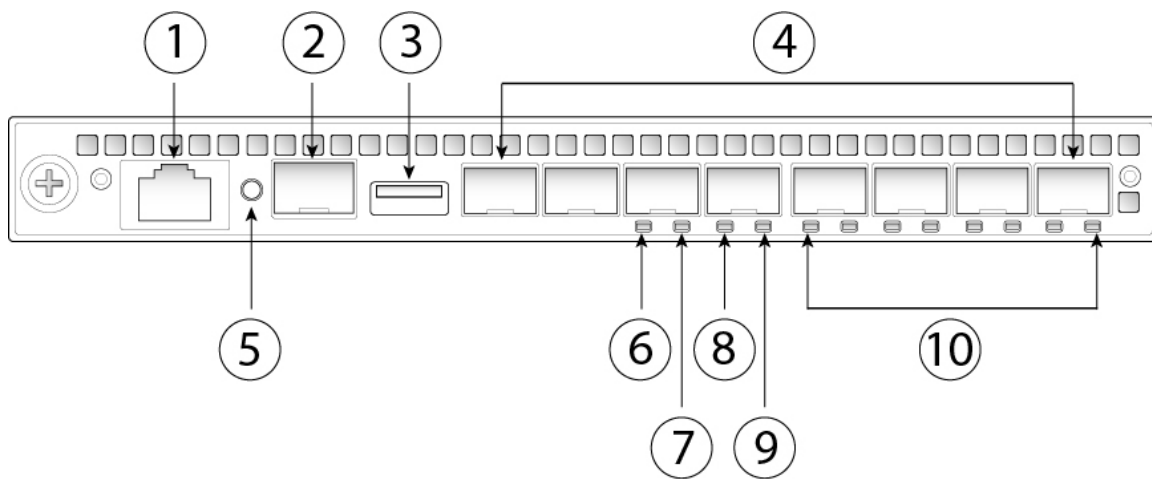


**Note** Unless you are running FXOS software, if you change the SFP transceiver for the management interface, you must reboot the Firepower 9300. FXOS then detects the new SFP module.

The Supervisor has the following ports:

- RJ-45 console port
- One Gigabit Ethernet SFP management port
- USB 3.0 Type A port
- Eight ports that support 1- or 10-Gigabit Ethernet SFPs (fiber and copper) (Ethernet 1/1 through 1/8)

*Figure 7: Firepower 9300 Supervisor Front Panel*



1	RJ-45 console port	2	Gigabit Ethernet management port
---	--------------------	---	----------------------------------

<b>3</b> USB Type A port	<b>4</b> 8 SFP/SFP+ ports that support 1-G or 10-G Ethernet (copper or fiber)
<b>5</b> Locator/Beacon (push button) and LED: <ul style="list-style-type: none"> <li>• Off—Locate is off.</li> <li>• Blue—Locate is on.</li> </ul>	<b>6</b> Management LED: <ul style="list-style-type: none"> <li>• Off—No connection or port is not in use.</li> <li>• Amber—No link or network failure.</li> <li>• Green—Link up.</li> <li>• Green, flashing—Network activity.</li> </ul>
<b>7</b> Power LED: <ul style="list-style-type: none"> <li>• Off—No power.</li> <li>• Green—System has power.</li> </ul>	<b>8</b> ACT LED This LED is not supported; reserved for future use.
<b>9</b> SYS LED: <ul style="list-style-type: none"> <li>• Off—System is not booting up yet.</li> <li>• Green, flashing—Power-up diagnostics is complete and the system is booting up.</li> <li>• Green—System has booted up successfully.</li> <li>• Amber—Power-up diagnostics have failed.</li> <li>• Amber, flashing—Alarm; power-up diagnostics are running.</li> </ul>	<b>10</b> Network port status LEDs: <ul style="list-style-type: none"> <li>• Off—No connection or port is not in use.</li> <li>• Amber—No link or network failure.</li> <li>• Green—Network activity up to 1 G.</li> <li>• Green, flashing—Network activity faster than 1 G.</li> </ul>

### RJ-45 Console Port

The Firepower 9300 has a standard RJ-45 console port. You can use the CLI to configure your Firepower 9300 through the RJ-45 serial console port by using a terminal server or a terminal emulation program on a computer.

The RJ-45 (8P8C) port supports RS-232 signaling to an internal UART controller. The console port does not have any hardware flow control, and does not support a remote dial-in modem. The baud rate is 9600. You can use the standard cable found in your accessory kit to convert the RJ-45 to DB-9 if necessary.

### Type A USB Port

You can use the external USB Type A port to attach a data storage device. The external USB drive identifier is `disk1:`. The USB Type A port supports the following:

- Hot swapping
- USB drive formatted with FAT32
- Boot kick-start image from the Supervisor ROMMON for discovery recovery purposes
- Copy files to and from workspace:/ and volatile:/ within local-mgmt. The most relevant files are:
  - Core files
  - Ethalyzer packet captures



- Tech-support files
- Security module log files
- Platform bundle image upload using **download image usbA:**

The USB Type A port does *not* support Cisco Secure Package (CSP) image upload.

### Network Ports

The Firepower 9300 chassis has eight ports that require SFP/SFP+/QSFP transceivers (fiber or copper). They are numbered from left to right starting with 1 and are named Ethernet 1/1 through Ethernet 1/8. The 9300 also has two network module slots that support different numbers of ports depending on the network module. See [Network Modules, on page 16](#) for the supported network modules. See for [Supported SFP/SFP+ and QSFP Transceivers, on page 28](#) the list of supported transceivers.

Each port has LEDs that represent link/activity status.

### Management Port

The Firepower 9300 chassis has a management port on the Supervisor that requires a 1-Gb fiber or copper SFP.

## Security Modules

The Firepower 9300 has three slots for security modules. The security modules are hot-swappable.



---

**Note** Make sure you have the correct firmware package and software version installed to support your security module. For instructions on how to verify your firmware package version and to upgrade the firmware if necessary, see the [Cisco Firepower 4100/9300 FXOS Firmware Upgrade Guide](#). See [Cisco Firepower 4100/9300 FXOS Compatibility](#) for the software compatibility matrix.

---

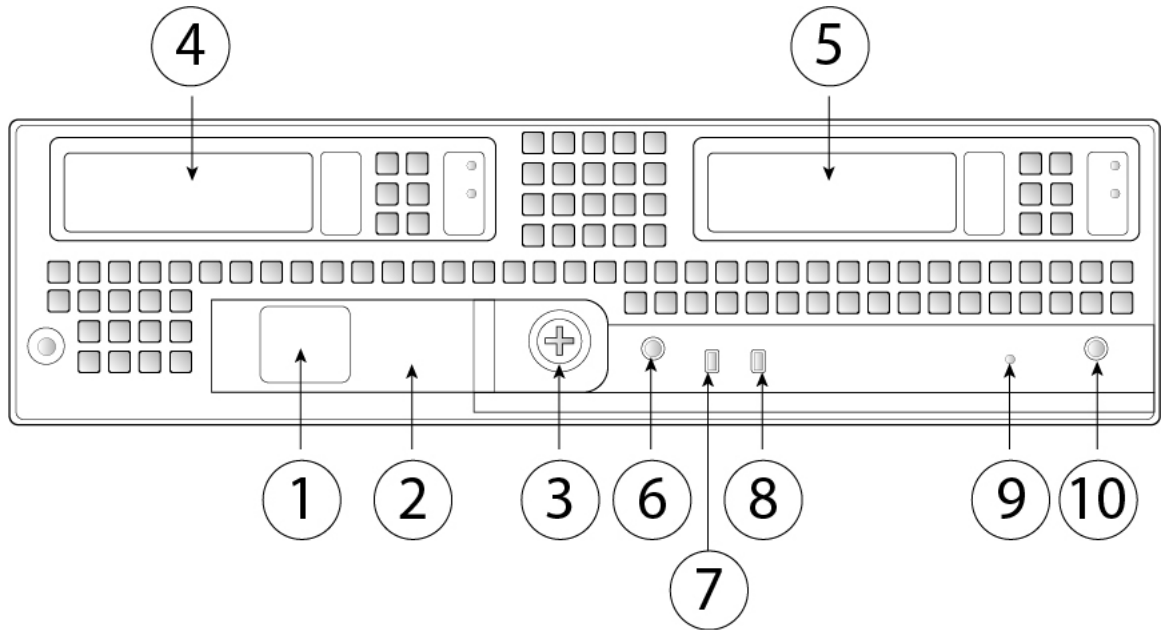


---

**Note** For FXOS software versions before version 2.6.1, all security modules in the chassis must be the same type; you cannot mix security module types. For version 2.6.1 and later, you can mix different types of security modules in the same chassis.

---

Figure 8: Firepower 9300 Security Module Front Panel



1	Paper tab for server name or serial number	2	Security module ejector handle
3	Ejector handle captive screw	4	SSD bay 1
5	SSD bay 2	6	Power button and LED <ul style="list-style-type: none"> <li>• Off—No power.</li> <li>• Green—System has power.</li> <li>• Amber—Standby power.</li> </ul>
7	Network link status LED <ul style="list-style-type: none"> <li>• Off—No network connection.</li> <li>• Green—At least one network is up.</li> <li>• Green, flashing—Network activity faster than 1 G.</li> </ul>	8	Security module health LED <ul style="list-style-type: none"> <li>• Off—Power off.</li> <li>• Green—Normal operation.</li> <li>• Amber—Minor error.</li> <li>• Amber, flashing—Critical error.</li> </ul>
9	Reset button <p><b>Note</b> The reset button is not in use. The functionality of the reset switch is disabled on the Firepower 9300.</p>	10	Locator/Beacon (push button) and LED <ul style="list-style-type: none"> <li>• Off—Locate is off.</li> <li>• Blue—Locate is on.</li> </ul>

There are six supported security modules:



---

**Note** SM-24, SM-36, and SM-44 are not supported in threat defense 7.3 and later or ASA 9.19 and later.

---

- SM-24—24-physical core CPU security module (NEBS ready)
- SM-36—36-physical core CPU high performance security module
- SM-40—40-physical core CPU Crypto security module (NEBS ready)
- SM-44—44-physical core CPU high performance security module (NEBS ready)
- SM-48—48-physical core CPU Crypto security module (NEBS ready)
- SM-56—56-physical core CPU Crypto security module

The SM-24, SM-36, and SM-44 have the following features:

- 256 GB of DDR4 memory.
- Two 800-GB SSDs.

The security module ships with two 800-GB SSDs in a default RAID 1 configuration that provides storage support. There are two LEDs on the front of the SSDs.

- One security acceleration module.

The SM-40, SM-48, and SM-56 have the following features:

- 384 GB of DDR4 memory.
- Two 1.6 TB SSDs.

The security module ships with two 1.6 TB SSDs in a default RAID 1 configuration that provides storage support. There are two LEDs on the front of the SSDs.

- One enhanced security acceleration module.



---

**Note** All security module components except the SSDs are fixed. You cannot configure or remove any of the other components.

---



---

**Caution** If you replace a security module with a new security module, you must decommission the old security module. See the "Security Module/Engine Management" chapter in the [FXOS Configuration Guide](#) for your software version for the instructions. See [Install, Remove, and Replace the Security Module](#) for the procedure for replacing security modules.

---

# Network Modules

The Firepower 9300 contains two network module slots that provide optical or electrical network interfaces. Network modules are optional, removable I/O modules that provide either additional ports or different interface types (1/10/40/100 Gb).

The Firepower network modules plug into the chassis on the front panel. You can also remove the divider between the two network module slots and insert a double-wide network module.

## For More Information

- See [10-Gb Network Module, on page 16](#) for a description of the 10-Gb network module.
- See [40-Gb Network Module, on page 17](#) for a description of the 40-Gb network module.
- See [100-Gb Network Module, on page 18](#) for a description of the 100-Gb two-port single-wide network module.
- See [100-Gb Network Module, on page 20](#) for a description of the 100-Gb four-port single-wide network module.
- See [100-Gb Network Module \(Double Wide\), on page 21](#) for a description of the 100-Gb double-wide network module.
- See [Supported SFP/SFP+ and QSFP Transceivers, on page 28](#) for a list of supported SFPs.
- See [Install, Remove, and Replace the Single-Wide Network Module, on page 66](#) for the procedure for removing and replacing single-wide network modules.
- See [Install, Remove, and Replace the Double-Wide Network Module, on page 71](#) for the procedure for removing and replacing double-wide network modules.

## 10-Gb Network Module

The following figure shows the front panel of the 10-Gb network module (FPR9K-NM-8X10G). The FPR9K-NM-8X10G is a single-wide module that supports hot swapping. The eight ports are numbered from top to bottom, left to right.



---

**Note** Make sure you have the correct firmware package and software version installed to support this network module. For instructions on how to verify your firmware package version and to upgrade the firmware if necessary, see the [Cisco Firepower 4100/9300 FXOS Firmware Upgrade Guide](#). See [Cisco Firepower 4100/9300 FXOS Compatibility](#) for the software compatibility matrix.

---



---

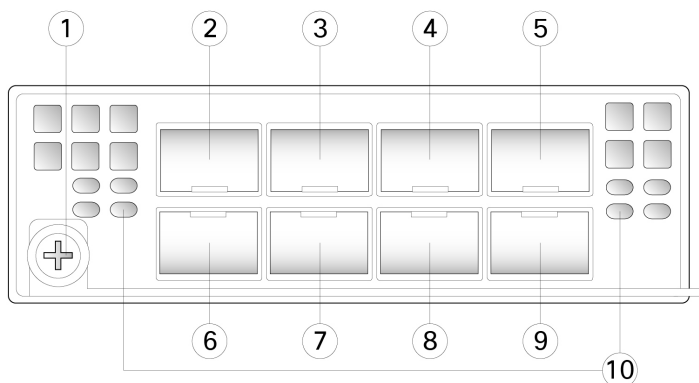
**Note** The FPR9K-NM-8X10G is NEBS-compliant.

---



**Note** You can fit four copper SFPs in either the top row of ports or the bottom row of ports. Both rows cannot be populated at the same time, because of the port row spacing.

**Figure 9: FPR9K-NM-8X10G**



1	Captive screw/handle	2	Ethernet X/1
3	Ethernet X/3	4	Ethernet X/5
5	Ethernet X/7	6	Ethernet X/2
7	Ethernet X/4	8	Ethernet X/6
9	Ethernet X/8	10	Network activity LEDs <ul style="list-style-type: none"> <li>• Off—No connection or port is not in use.</li> <li>• Amber—No link or network failure.</li> <li>• Green—Link up.</li> <li>• Green, flashing—Network activity.</li> </ul>

**For More Information**

- For a list of copper SFPs, see [Supported SFP/SFP+ and QSFP Transceivers, on page 28](#).

## 40-Gb Network Module

The following figure shows the front panel of the 40-Gb network module (FPR9K-NM-4X40G.) The FPR9K-NM-4X40G is a single-wide module that supports hot swapping. The four ports are numbered left to right.

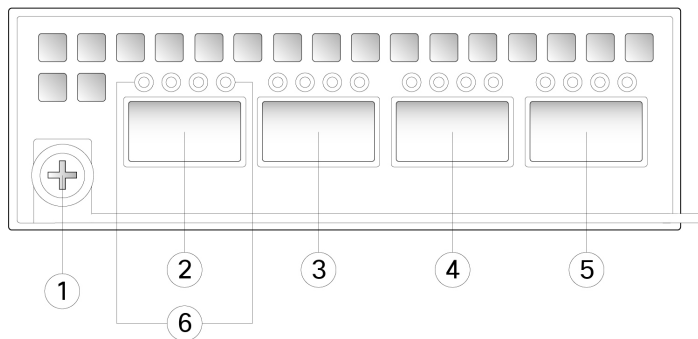


**Note** Make sure you have the correct firmware package and software version installed to support this network module. For instructions on how to verify your firmware package version and to upgrade the firmware if necessary, see the [Cisco Firepower 4100/9300 FXOS Firmware Upgrade Guide](#). See [Cisco Firepower 4100/9300 FXOS Compatibility](#) for the software compatibility matrix.



**Note** The FPR9K-NM-4X40G is NEBS-compliant.

**Figure 10: FPR9K-NM-4X40G**



<b>1</b>	Captive screw/handle	<b>2</b>	Network activity LEDs <ul style="list-style-type: none"> <li>• Off—No connection or port is not in use.</li> <li>• Amber—No link or network failure.</li> <li>• Green—Link up.</li> <li>• Green, flashing—Network activity.</li> <li>• 40Gb—Only the leftmost LED indicates the port status.</li> <li>• 4x10Gb—Each of the port LEDs indicates the status of respective 10-Gb channel.</li> </ul>
<b>3</b>	Ethernet X/1	<b>4</b>	Ethernet X/2
<b>5</b>	Ethernet X/3	<b>6</b>	Ethernet X/4

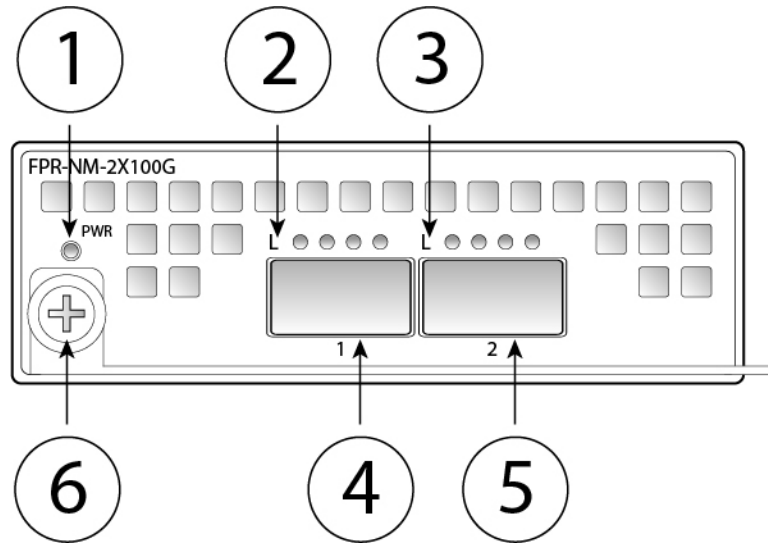
## 100-Gb Network Module

The following figure shows the front panel of the 100-Gb network module (FPR9K-NM-2X100G). The FPR9K-NM-2X100G is a two-port single-wide module that supports hot swapping. The two ports are numbered left to right.



**Note** Make sure you have the correct firmware package and software version installed to support this network module. For instructions on how to verify your firmware package version and to upgrade the firmware if necessary, see the [Cisco Firepower 4100/9300 FXOS Firmware Upgrade Guide](#). See [Cisco Firepower 4100/9300 FXOS Compatibility](#) for the software compatibility matrix.

Figure 11: FPR9K-NM-2X100G



1	Power LED	2	Network activity LEDs <ul style="list-style-type: none"> <li>• Off—No connection or port is not in use.</li> <li>• Amber—No link or network failure.</li> <li>• Green—Link up.</li> <li>• Green, flashing—Network activity.</li> </ul>
3	Network activity LEDs <ul style="list-style-type: none"> <li>• Off—No connection or port is not in use.</li> <li>• Amber—No link or network failure.</li> <li>• Green—Link up.</li> <li>• Green, flashing—Network activity.</li> </ul>	4	Ethernet X/1
5	Ethernet X/2	6	Captive screw/handle

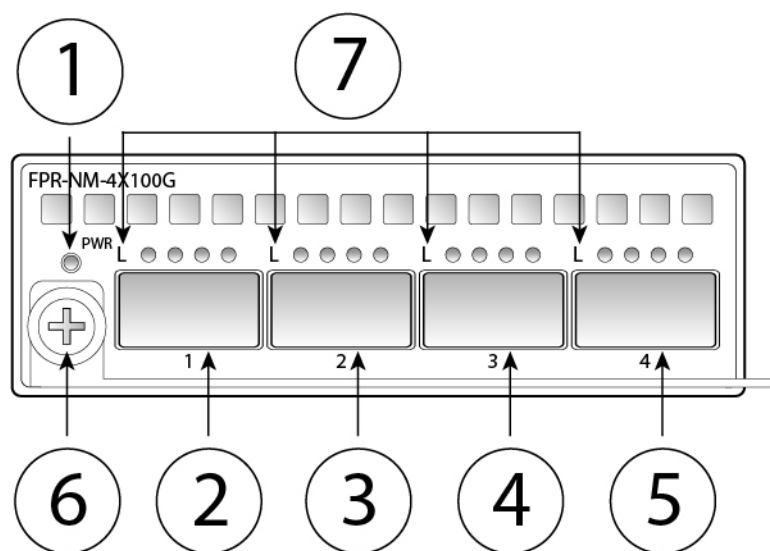
## 100-Gb Network Module

The following figure shows the front panel of the 100-Gb network module (FPR9K-NM-4X100G). The FPR9K-NM-4X100G is a four-port single-wide module that supports hot swapping. The four ports are numbered left to right.



**Note** Make sure you have the correct firmware package and software version installed to support this network module. For instructions on how to verify your firmware package version and to upgrade the firmware if necessary, see the [Cisco Firepower 4100/9300 FXOS Firmware Upgrade Guide](#). See [Cisco Firepower 4100/9300 FXOS Compatibility](#) for the software compatibility matrix.

Figure 12: FPR9K-NM-4X100G



1	Power LED	2	Ethernet X/1
3	Ethernet X/2	4	Ethernet X/3
5	Ethernet X/4	6	Captive screw/handle
7	Network activity LEDs <ul style="list-style-type: none"> <li>• Off—No connection or port is not in use.</li> <li>• Amber—No link or network failure.</li> <li>• Green—Link up.</li> <li>• Green, flashing —Network activity.</li> </ul>		—



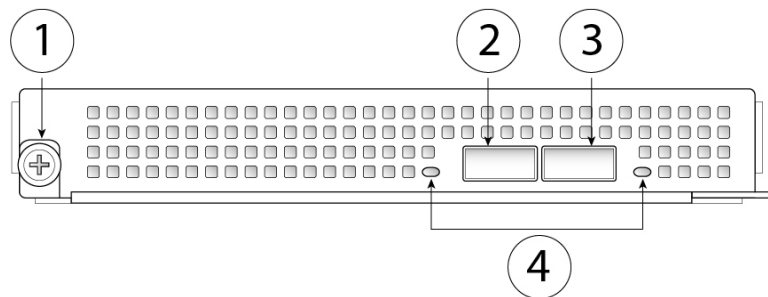
## 100-Gb Network Module (Double Wide)

The following figure shows the front panel of the 100-Gb network module (FPR9K-DNM-2X100G). The FPR9K-DNM-2X100G is a double-wide module that does *not* support hot swapping. The two ports are numbered left to right.



**Note** Make sure you have the correct firmware package and software version installed to support this network module. For instructions on how to verify your firmware package version and to upgrade the firmware if necessary, see the [Cisco Firepower 4100/9300 FXOS Firmware Upgrade Guide](#). See [Cisco Firepower 4100/9300 FXOS Compatibility](#) for the software compatibility matrix.

Figure 13: FPR9K-DNM-2X100G



1	Captive screw/handle	2	100-Gigabit Ethernet QSFP28 fiber port Ethernet X/1
3	100-Gigabit Ethernet QSFP28 fiber port Ethernet X/2	4	Network activity LEDs <ul style="list-style-type: none"> <li>• Unlit—No connection or port is not in use.</li> <li>• Amber—No link or network failure.</li> <li>• Green, flashing—Network activity.</li> </ul>

## Hardware Bypass Network Modules

Hardware bypass (also known as fail-to-wire) is a physical layer (Layer 1) bypass that allows paired interfaces to go into bypass mode so that the hardware forwards packets between these port pairs without software intervention. Hardware bypass provides network connectivity when there are software or hardware failures. Hardware bypass is useful on ports where the Firepower security appliance is only monitoring or logging traffic. The hardware bypass network modules have an optical switch that is capable of connecting the two ports when needed. The hardware bypass network modules have built-in SFPs.

Hardware bypass is supported only on a fixed set of ports. You can pair Port 1 with Port 2, Port 3 with Port 4, but you cannot pair Port 1 with Port 4 for example.



---

**Note** When the appliance switches from normal operation to hardware bypass or from hardware bypass back to normal operation, traffic may be interrupted for several seconds. A number of factors can affect the length of the interruption; for example, behavior of the optical link partner such as how it handles link faults and debounce timing; spanning tree protocol convergence; dynamic routing protocol convergence; and so on. During this time, you may experience dropped connections.

---

There are three configuration options for hardware bypass network modules:

- **Passive interfaces**—Connection to a single port.

For each network segment you want to monitor passively, connect the cables to one interface. This is how the nonhardware bypass network modules operate.

- **Inline interfaces**—Connection to any two like ports (10 Gb to 10 Gb for example) on one network module, across network modules, or fixed ports.

For each network segment you want to monitor inline, connect the cables to pairs of interfaces.

- **Inline with hardware bypass interfaces**—Connection of a hardware bypass paired set.

For each network segment that you want to configure inline with fail-open, connect the cables to the paired interface set.

For the 40-Gb network module, you connect the two ports to form a paired set. For the 1/10-Gb network modules, you connect the top port to the bottom port to form a hardware bypass paired set. This allows traffic to flow even if the security appliance fails or loses power.



---

**Note** If you have an inline interface set with a mix of hardware bypass and nonhardware bypass interfaces, you cannot enable hardware bypass on this inline interface set. You can only enable hardware bypass on an inline interface set if all the pairs in the inline set are valid hardware bypass pairs.

---

#### For More Information

- See [40-Gb Network Module with Hardware Bypass](#), on page 22 for a description of the 40-Gb network module.
- See [10-Gb SR/10-Gb LR Network Module with Hardware Bypass](#), on page 24 for a description of the 1-Gb SX, 10-Gb SR and LR network modules.
- See [Install, Remove, and Replace the Single-Wide Network Module](#), on page 66 for the procedure for removing and replacing single-wide network modules.

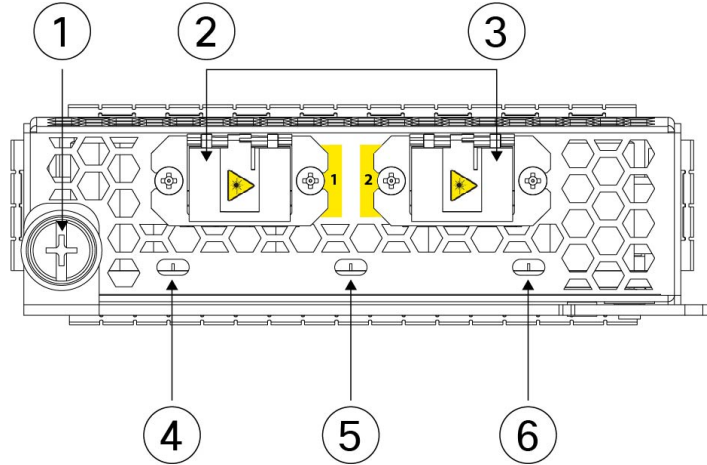
## 40-Gb Network Module with Hardware Bypass

The following figure shows the front panel of the 40-Gb hardware bypass network module (FPR9K-NM-2X40G-F). The FPR9K-NM-2X40G-F is a single-wide module that does *not* support hot swapping. The two ports are numbered left to right. Pair the two ports to create a hardware bypass paired set.



**Note** Make sure you have the correct firmware package and software version installed to support this network module. For instructions on how to verify your firmware package version and to upgrade the firmware if necessary, see the [Cisco Firepower 4100/9300 FXOS Firmware Upgrade Guide](#). See [Cisco Firepower 4100/9300 FXOS Compatibility](#) for the software compatibility matrix.

Figure 14: FPR9K-NM-2X40G-F



1	Captive screw/handle	2	Port 1 Ethernet X/1 Ports 1 and 2 are paired together to form a hardware bypass pair.
3	Port 2 Ethernet X/2 Ports 1 and 2 are paired together to form a hardware bypass pair.	4	Port 1 network activity LEDs: <ul style="list-style-type: none"> <li>• Amber—No connection, or port is not in use, or no link or network failure.</li> <li>• Green—Link up, no network activity.</li> <li>• Green, flashing—Network activity.</li> </ul>
5	BP (bypass LED): <ul style="list-style-type: none"> <li>• Green—In standby mode.</li> <li>• Amber, flashing—Port is in hardware bypass mode, failure event.</li> </ul>	6	Port 2 network activity LEDs: <ul style="list-style-type: none"> <li>• Amber—No connection, or port is not in use, or no link or network failure.</li> <li>• Green—Link up, no network activity.</li> <li>• Green, flashing—Network activity.</li> </ul>

The following table describes the cable specifications needed to keep the insertion loss as low as possible.

Table 2: 40-Gb BASE-SR Cable Specifications

Interface	Supported Cable
Ethernet 40-G BASE-SR4	50 microns core diameter
850 nm wavelength	2000/4700 (OM3/4) modal bandwidth (MHz*km)
MPO-12 port adapter	50 m cable distance



**Note** See the [Cisco 40GBASE QSFP Modules Data Sheet](#) for specifications of the QSFP for the 40-Gb BASE-SR-4.

We recommend the following Cisco OM3 MTP/MPO cables.

Table 3: Cisco Cables

Cisco Part Number	Cable Length
CAB-ETH-40G-5M	5 m
CAB-ETH-40G-10M	10 m
CAB-ETH-40G-20M	20 m

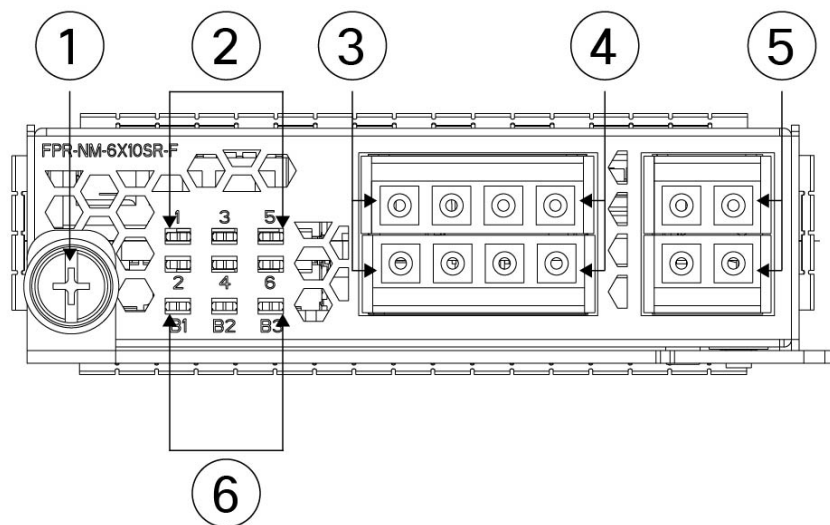
## 10-Gb SR/10-Gb LR Network Module with Hardware Bypass

The following figure shows the front panel of the 10-Gb SR and 10-Gb LR hardware bypass network modules (FPR9K-NM-6X10SR-F, FPR9K-NM-6X10LR-F). This is a single-wide module that does *not* support hot swapping. The six ports are numbered from top to bottom, left to right. Pair ports 1 and 2, 3 and 4, and 5 and 6 to form hardware bypass paired sets.



**Note** Make sure you have the correct firmware package and software version installed to support this network module. For instructions on how to verify your firmware package version and to upgrade the firmware if necessary, see the [Cisco Firepower 4100/9300 FXOS Firmware Upgrade Guide](#). See [Cisco Firepower 4100/9300 FXOS Compatibility](#) for the software compatibility matrix.

Figure 15: FPR9K-NM-6X10SR-F, FPR9K-NM-6X10LR-F



1	Captive screw/handle	2 Six network activity LEDs: <ul style="list-style-type: none"> <li>• Amber—No connection, or port is not in use, or no link or network failure.</li> <li>• Green—Link up, no network activity.</li> <li>• Green, flashing—Network activity.</li> </ul>
3	Ethernet X/1 (top port) Ethernet X/2 (bottom port) Ports 1 and 2 are paired together to form a hardware bypass pair.	4 Ethernet X/3 (top port) Ethernet X/4 (bottom port) Ports 3 and 4 are paired together to form a hardware bypass pair.
5	Ethernet X/5 (top port) Ethernet X/6 (bottom port) Ports 5 and 6 are paired together to form a hardware bypass pair.	6 Bypass LEDs B1 through B3: <ul style="list-style-type: none"> <li>• Green—In standby mode.</li> <li>• Amber, flashing—Port is in hardware bypass mode, failure event.</li> </ul>

The 10-Gb SR/10-Gb LR network modules have the following insertion loss measurements. Insertion loss measurements help you to troubleshoot the network by verifying cable installation and performance.

Table 4: 10-Gb SR Network Module (FPR9K-NM-6X10SR-F)

	Operating Mode	Typical	Maximum
Insertion loss	Normal	0.9 dB	1.4 dB
	Hardware bypass	1.2 dB	1.7 dB

	Core diameter (microns)	Modal bandwidth (MHz/km)	Cable distance <b>Note</b> Half the distance specified by the IEEE standard.
Cable and operating distance	62.5	160 (FDDI)	13 m
	62.5	200 (OM1)	16.5 m
	50	400	33 m
	50	500 (OM2)	41 m
	50	2000 (OM3)	150 m
	50	4700 (OM4)	200 m

**Table 5: 10-Gb LR Network Module (FPR9K-NM-6X10LR-F)**

	Operating Mode	Typical	Maximum
Insertion loss	Normal	1.2 dB	1.6 dB
	Hardware bypass	1.5 dB	1.9 dB
	Core diameter (microns)	Modal bandwidth (MHz/km)	Cable distance <b>Note</b> Half the distance specified by the IEEE standard.
Cable and operating distance	G.652	Single mode	5 km

## Power Supply Modules

The Firepower 9300 supports two AC, two DC, or two high-voltage DC (HVDC) power supply modules so that dual power supply redundancy protection is available. Facing the front of the chassis, the power supply modules are numbered left to right, for example, PSU-1 and PSU-2.



**Attention** Make sure that one power supply module is always active.

### AC Power Supply Modules

The 220-V power supply modules run at 2500 W for 200 to 240 V AC. The load is shared when both power supply modules are plugged in and running at the same time. The power supply modules support

hot swapping. The power supply entry module is not removable. This is the module that you plug the power cords into.



**Note** After removing power from the chassis either by moving the power switch to OFF or unplugging the power cord, wait at least 10 seconds before turning power back ON.

**Table 6: AC Power Supply LEDs**

	Power Switch Position	Green LED	Amber LED
No input AC power	On	Off	Off
	Off	Off	Off
Power supply failure	On	Off	On
	Off	Off	Flashing Power supply warning, must be reset by the system
Power present	On	On Normal operation	Off
	Off	Flashing (1 Hz) 12-V output disabled	Off

### DC Power Supply Module

The power switch controls the DC power output. The system input power is +12 V. If the power switch is off (standby) when input DC (-48 V) is present, the main power is turned off and only +3.3 V standby is available for the system. If the power switch position is on (active) when input DC (-48 V) is present, the main power is turned on as well as +3.3 V standby, and the system is running.



**Note** After removing power from the chassis either by moving the power switch to OFF or unplugging the power cord, wait at least 10 seconds before turning power back ON.

The following table describes the DC power supply LEDs.

**Table 7: DC Power Supply Module LEDs**

Input DC Power -48V	Power Switch Position	Green LED	Amber LED
No input DC power	On	Off	Off
	Off	Off	Off

Power supply failure	On	Off	On
	Off	Off	Off
Input DC present	On	On	Off
	Off	Flashing (1 Hz)	Off

### HVDC Power Supply Module

The HVDC power supply modules run at 2500 W for +240 to +380 V DC. The load is shared when both power supply modules are plugged in and running at the same time. The power supply modules are hot-swappable. The power supply entry module is not removable. This is the module that you plug the power cords into.

### For More Information

- See [Remove and Replace the Power Supply Module, on page 75](#) for the procedure for removing and replacing the power supply module.
- See [Connect the DC Power Supply Module, on page 80](#) for the procedure for connecting the DC power supply module.
- See [Connect the HVDC Power Supply Module, on page 83](#) for the procedure for connecting the HVDC power supply module.
- See [Hardware Specifications, on page 31](#) for the power supply hardware specifications.

## Fan Modules

The Firepower 9300 requires four fan modules, which are hot-swappable. They are installed in the rear of the chassis. When you remove a fan module, make sure you replace it quickly to avoid overheating the system.

The fan modules are numbered left to right, for example, FAN-1, FAN-2, FAN-3, and FAN-4.

The fan modules have the following LEDs:

- Amber, flashing—Fan failure.
- Green—Fan running normally.

### For More Information

See [Remove and Replace the Fan Module, on page 87](#) for the procedure for removing and replacing fan modules.

## Supported SFP/SFP+ and QSFP Transceivers

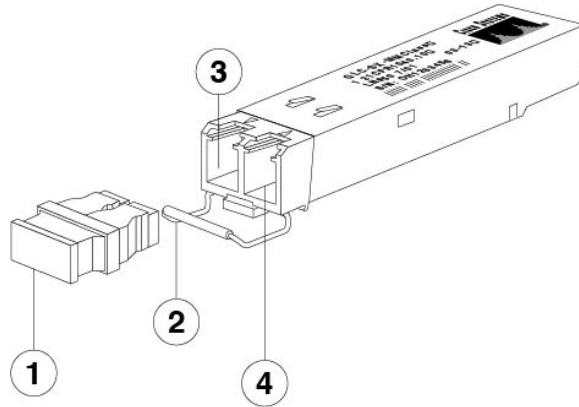
The SFP/SFP+ and QSFP transceivers are bidirectional devices with a transmitter and receiver in the same physical package. They are a hot-swappable optical or electrical (copper) interface that plugs into the SFP/SFP+/QSFP ports on the fixed ports and the network module ports, and provides Ethernet connectivity.





**Warning** Use appropriate ESD procedures when inserting the transceiver. Avoid touching the contacts at the rear, and keep the contacts and ports free of dust and dirt. Keep unused transceivers in the ESD packing that they were shipped in. The following figure shows a sample SFP transceiver.

Figure 16: SFP



1	Dust plug	2	Bail clasp
3	Receive optical bore	4	Transmit optical bore

**Safety Warnings**

Take note of the following optical connection warnings:



**Warning Statement 1051—Laser Radiation**  
 Invisible laser radiation may be emitted from disconnected fibers or connectors. Do not stare into beams or view directly with optical instruments.



**Warning Statement 1055—Class 1/1M Laser**  
 Invisible laser radiation is present. Do not expose to users of telescopic optics. This applies to Class 1/1M laser products.



**Caution** Although non-Cisco SFPs are allowed, we do not recommend using them because they have not been tested and validated by Cisco. Cisco TAC may refuse support for any interoperability problems that result from using an untested third-party SFP transceiver.

The following table lists the Cisco supported transceivers.

**Table 8: Supported Cisco SFP/SFP+ and QSFP Transceivers**

Optics Type	PID
<b>1 Gb</b>	
1G-SX	GLC-SX-MMD
1G-LH/LX	GLC-LH-SMD
1G-EX	GLC-EX-SMD
1G-ZX	GLC-ZX-SMD
1G 1000Base-T	GLC-T
1G 1000Base-T	GLC-TE
<b>10 Gb</b>	
10G-SR	SFP-10G-SR
10G-SR-S	SFP-10G-SR-S
10G-LR	SFP-10G-LR
10G-LR-S	SFP-10G-LR-S
10G-LRM	SFP-10G-LRM
10G-ER	SFP-10G-ER
10G-ER-S	SFP-10G-ER-S
10G-ZR-S	SFP-10G-ZR-S
10G Cu, 1m	SFP-H10GB-CU1M
10G Cu, 1.5m	SFP-H10GB-CU1-5M
10G Cu, 2m	SFP-H10GB-CU2M
10G Cu, 2.5m	SFP-H10GB-CU2-5M
10G Cu, 3m	SFP-H10GB-CU3M
10G Cu, 5m	SFP-H10GB-CU5M
10G Cu, 7m	SFP-H10GB-ACU7M
10G Cu, 10m	SFP-H10GB-ACU10M
10G AOC, 1m	SFP-10G-AOC1M
10G AOC, 2m	SFP-10G-AOC2M

10G AOC, 3m	SFP-10G-AOC3M
10G AOC, 5m	SFP-10G-AOC5M
10G AOC, 7m	SFP-10G-AOC7M
10G AOC, 10m	SFP-10GAOC10M
<b>40 Gb</b>	
40G-SR4	QSFP-40G-SR4
40G-SR4-S	QSFP-40G-SR4-S
40G-CSR4	QSFP-40G-CSR4
40G-SR-BD	QSFP-40G-SR-BD
40GE-LR4	QSFP-40GE-LR4
40GE-LR4-S	QSFP-40GE-LR4-S
40G-LR4L	WSP-Q40GLR4L
40G-CU, 1M, 3M, 5M	Cisco QSFP-H40G-CU
40G-4X10G-CU, 1M, 3M, 5M	QSFP-4SFP10G-CU
40G-CU-A, 7M, 10M	Cisco QSFP-H40G-ACU
40G-4X10G-CU-A, 7M, 10M	QSFP-4X10G-AC
40G-AOC, 1M, 2M, 3M, 5M, 7M, 10M, 15M	QSFP-H40G-AOC
<b>100 Gb</b>	
100G-SR4-S	QSFP-100G-SR4-S
100G-LR4-S	QSFP-100G-LR4-S
100G-AOC, 1m, 2m, 3m, 5m, 7m, 10m, 15m, 20m, 25m, 30m	QSFP-100G-AOCxM
100G-CUxM, 1m, 2m, 3m, 5m	QSFP-100G-CUxM  <b>Note</b> Supported only on the 2- and 4-port 100-Gb single-wide network modules (FPR-NM-2X100G and FPR-NM-4X100G).

## Hardware Specifications

The following table contains hardware specifications for the Firepower 9300.

<b>Physical Specifications for the 9300 Chassis</b>	
Dimensions (H x W x D)	5.25 x 17.5 x 32 inches (13.3 x 44.5 x 81.3 cm)
Weight	105 lb (47.7 kg) with one security module 135 lb (61.2 kg) fully configured
<b>Physical Specification for the 9300 Security Module</b>	
Dimensions	1.95 x 8 x 24.2 inches (50 x 203 x 620 mm)
Weight	15.5 lb (7.03 kg)
<b>Memory Per 9300 Security Module</b>	
DDR4 DIMM	256 GB—SM-24, SM-36, SM-44 <b>Note</b> The SM-24, SM-36, and SM-44 are not supported on Version 7.3 and later. 384 GB—SM-40, SM-48, SM-56
<b>Power</b>	
Input voltage	AC: 200 to 240 V AC DC: -40 to -60 V DC HVDV: 240 to 380 V DC
Maximum output power	AC: 2500 W DC: 2500 W HVDC: 2500 W
Maximum input current	AC: 15.5 A to 12.9 A DC: 69 A to 42 A HVDC: <14 A at 200 V
Redundancy	1+1
Frequency	50 to 60 Hz
Efficiency	92 % (at 50 % load)
<b>Environment</b>	
Operating temperature	SM-24 security module: 32 to 104° F (0 to 40° C) SM-36, SM-44, SM-40, SM-48 SM-56 security modules: 32 to 88° F (0 to 35° C) at sea-level
Nonoperating temperature	-40 to 149° F (-40 to 65° C); maximum altitude is 40,000 ft

Temperature NEBS	<p>Long Term: 0 to 45° C up to 6000 ft (1829 m)</p> <p>Long Term: 0 to 35° C, 6000-13000 ft (1829-3964 m)</p> <p>Short Term: -5 to 55° C, up to 6000 ft (1829 m)</p> <p><b>Note</b> Firepower 9300 NEBS compliance applies only to the SM-24 and SM-44 security module configurations.</p>
Humidity	5 to 95 % noncondensing (operating and nonoperating)
Operating altitude	<p>SM-24 security module: 0 to 13,000 ft (3962 m)</p> <p>SM-36, SM-44, SM-40, SM-48, SM-56 security modules: 0 to 10,000 ft (3048 m)</p>
Nonoperating altitude	40,000 ft (12,192 m)
Acoustic noise	75.5 dBA at maximum fan speed

## Product ID Numbers

The following table lists the PIDs associated with the Firepower 9300. All of the PIDs in the table are field-replaceable. If you need to get a return material authorization (RMA) for any component, see [Cisco Returns Portal](#) for more information.



**Note** See the **show inventory** command in the [Cisco Firepower 4100/9300 FXOS Command Reference](#), in the [Cisco Firepower Threat Defense Command Reference](#), or in the [Cisco ASA Series Command Reference](#) to display a list of the PIDs for your Firepower 9300.

**Table 9: Firepower 9300 PIDs**

PID	Description
FPR-C9300=	Firepower 9300 chassis, no power supply modules and no fan modules (spare)
FPR-C9300-AC	Firepower 9300 chassis for AC power
FPR-C9300-AC=	Firepower 9300 chassis for AC power, no power supply modules and no fan modules (spare)
FPR-C9300-DC	Firepower 9300 chassis for DC power, two power supply modules and four fan modules
FPR-C9300-DC=	Firepower 9300 chassis for DC power, two power supply modules and four fan modules (spare)
FPR-C9300-HVDC	Firepower 9300 chassis for HVDC power supply, two power supply modules and four fan modules

PID	Description
FPR-C9300-HVDC=	Firepower 9300 chassis for HVDC power, no power supply modules and no fan modules (spare)
FPR-C9300-FIPSKIT=	Firepower 9300 chassis FIPS kit (spare)
FPR9K-SUP	Firepower 9000 series Supervisor
FPR9K-SUP=	Firepower 9000 series Supervisor (spare)
FPR9K-SM-24	Firepower 9000 series security module
FPR9K-SM-24=	Firepower 9000 series security module (spare)
FPR9K-SM-24-NEB	Firepower 9000 series NEBS security module
FPR9K-SM-24-NEB=	Firepower 9000 series NEBS security module (spare)
FPR9K-SM-36	Firepower 9000 series high performance security module
FPR9K-SM-36=	Firepower 9000 series high performance security module (spare)
FPR9K-SM-40	Firepower 9000 series Crypto security module
FPR9K-SM-40=	Firepower 9000 series Crypto security module (spare)
FPR9K-SM-40-NEB	Firepower 9000 series NEBS Crypto security module
FPR9K-SM-40-NEB=	Firepower 9000 series NEBS Crypto security module (spare)
FPR9K-SM-44	Firepower 9000 series high performance security module
FPR9K-SM-44=	Firepower 9000 series high performance security module (spare)
FPR9K-SM-44-NEB	Firepower 9000 series NEBS security module
FPR9K-SM-44-NEB=	Firepower 9000 series NEBS security module (spare)
FPR9K-SM-48	Firepower 9000 series Crypto security module
FPR9K-SM-48=	Firepower 9000 series Crypto security module (spare)
FPR9K-SM-48-NEB	Firepower 9000 series NEBS Crypto security module
FPR9K-SM-48-NEB=	Firepower 9000 series NEBS Crypto security module (spare)
FPR9K-SM-56	Firepower 9000 series Crypto security module
FPR9K-SM-56=	Firepower 9000 series Crypto security module (spare)

PID	Description
FPR9K-SM-BLANK	Firepower 9000 series security module blank slot cover
FPR9K-SM-BLANK=	Firepower 9000 series security module blank slot cover (spare)
FPR9K-DNM-2X100G	Firepower 2-port 100-Gb double-wide network module
FPR9K-DNM-2X100G=	Firepower 2-port 100-Gb double-wide network module (spare)
FPR9K-DNM2X100G-RF	Firepower 2-port 100-Gb double-wide network module, REMANUFACTURED
FPR9K-NM-2X100G	Firepower 2-port 100-Gb single-wide network module
FPR9K-NM-2X100G=	Firepower 2-port 100-Gb single-wide network module (spare)
FPR9K-NM-4X100G	Firepower 4-port 100-Gb single-wide network module
FPR9K-NM-4X100G=	Firepower 4-port 100-Gb single-wide network module (spare)
FPR9K-NM-2X40G-F	Firepower 2-port 40-Gb SR hardware bypass network module
FPR9K-NM-2X40G-F=	Firepower 2-port 40-Gb SR hardware bypass network module (spare)
FPR9K-NM-4X40G	Firepower 9000 series 4-port 40-Gb QSFP+ network module
FPR9K-NM-4X40G=	Firepower 9000 series 4-port 40-Gb QSFP+ network module (spare)
FPR9K-NM-6X10LR-F	Firepower 6-port 10-Gb LR hardware bypass network module
FPR9K-NM-6X10LR-F=	Firepower 6-port 10-Gb LR hardware bypass network module (spare)
FPR9K-NM-6X10SR-F	Firepower 6-port 10-Gb SR hardware bypass network module
FPR9K-NM-6X10SR-F=	Firepower 6-port 10-Gb SR hardware bypass network module (spare)
FPR9K-NM-8X10G	Firepower 9000 series 8-port 10-Gb SFP+ network module

PID	Description
FPR9K-NM-8X10G=	Firepower 9000 series 8-port 10-Gb SFP+ network module (spare)
FPR9K-NM-BLANK	Firepower 9000 series network module blank slot cover
FPR9K-NM-BLANK=	Firepower 9000 series network module blank slot cover (spare)
FPR9K-NM-DV	Firepower 9000 series network module divider
FPR9K-PS-AC	Firepower 9000 series AC power supply module
FPR9K-PS-AC=	Firepower 9000 series AC power supply module (spare)
FPR9K-PS-DC	Firepower 9000 series DC power supply module
FPR9K-PS-DC=	Firepower 9000 series DC power supply module (spare)
FPR9K-PS-HVDC	Firepower 9000 series HVDC power supply module
FPR9K-PS-HVDC=	Firepower 9000 series HVDC power supply module (spare)
FPR9K-FAN	Firepower 9000 series fan module
FPR9K-FAN=	Firepower 9000 series fan module (spare)
FPR9K-SM-S800GS1	Firepower 9000 series 800-GB SSD for the SM-24, SM-36, and SM-44 security modules
FPR9K-SM-S800GS1=	Firepower 9000 series 800-GB SSD for the SM-24, SM-36, and SM-44 security modules (spare)
FPR9K-SM-SSD1.6TB	Firepower 9000 series 1.6-TB SSD for the SM-40, SM-48, and SM-56 security modules
FPR9K-SM-SSD1.6TB=	Firepower 9000 series 1.6-TB SSD for the SM-40, SM-48, and SM-56 security modules (spare)
FPR9K-RMK	Firepower 9000 series rack-mount kit
FPR9K-RMK=	Firepower 9000 series rack-mount kit (spare)

## Power Cord Specifications

Each power supply has a separate power cord. Standard power cords or jumper power cords are available for connection to the security appliance. The jumper power cords for use in racks are available as an optional



alternative to the standard power cords. The chassis ships with one power cord; the default is the US version. You must choose the country-specific power cord when ordering your security appliance.

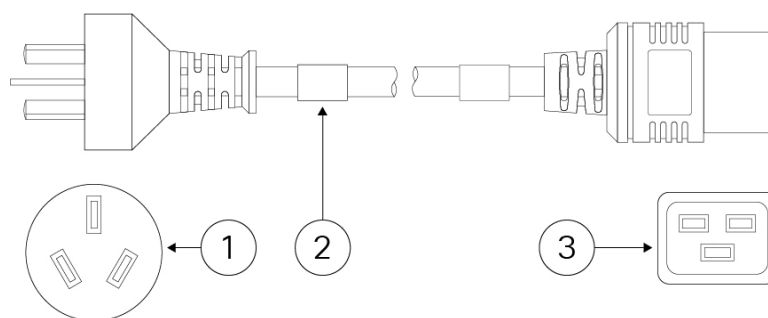
If you do not order the optional power cord with the system, you are responsible for selecting the appropriate power cord for the product. Using an incompatible power cord with this product may result in electrical safety hazard. Orders delivered to Argentina, Brazil, and Japan must have the appropriate power cord ordered with the system.



**Note** Only the approved power cords or jumper power cords provided with the security appliance are supported.

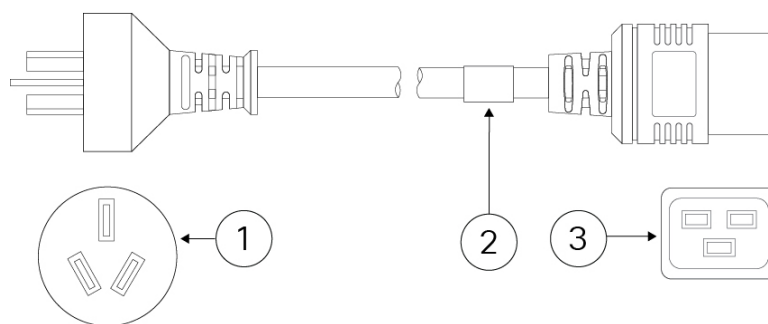
The following power cords are supported:

**Figure 17: Argentina CAB-IR2073-C19-AR**



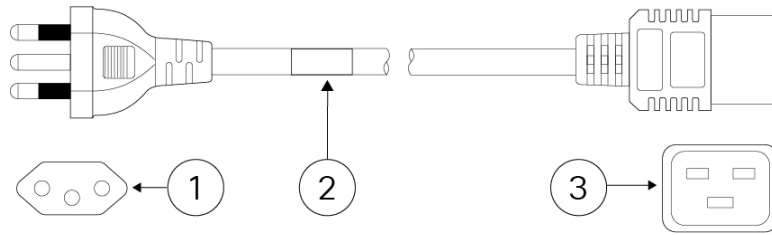
<b>1</b>	Plug: IRAM 2073	<b>2</b>	Cord set rating: 16 A, 250 V
<b>3</b>	Connector: IEC 60320/C19		

**Figure 18: Australia CAB-AC-16A-AUS**



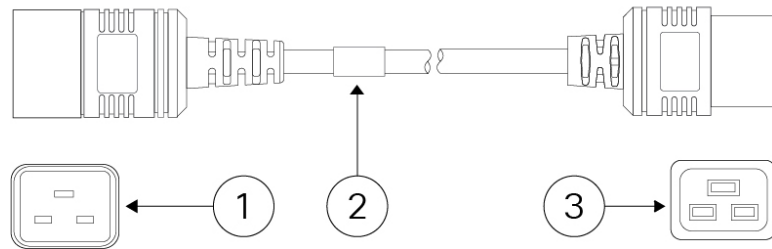
<b>1</b>	Plug: AS/NZS 3112:2011 + A1	<b>2</b>	Cord set rating: 16 A, 250 V
<b>3</b>	Connector: IEC 60320/C19		

**Figure 19: Brazil UCSB-CABL-C19-BRZ**



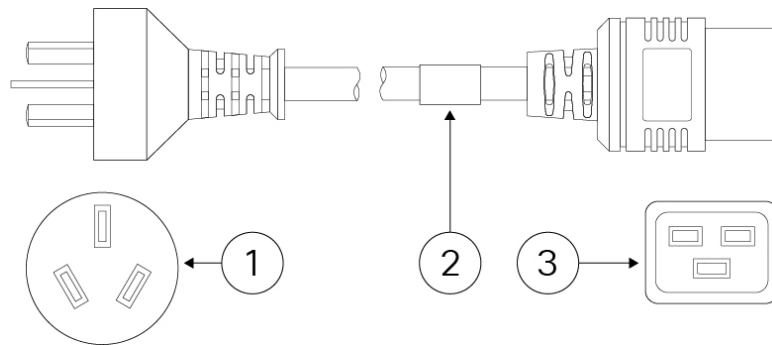
<b>1</b>	Plug: NBR 14136	<b>2</b>	Cord set rating: 16 A, 250 V
<b>3</b>	Connector: IEC 60320/C19		

**Figure 20: Cabinet Jumper Power Cord CAB-C19-CBN**



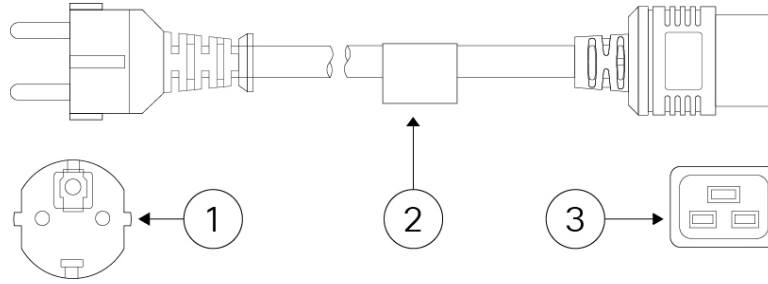
<b>1</b>	Plug: IEC 60320/20	<b>2</b>	Cord set rating: 16 A, 250 V
<b>3</b>	Connector: IEC 60320/C19		

**Figure 21: China CAB-AC16A-CH**



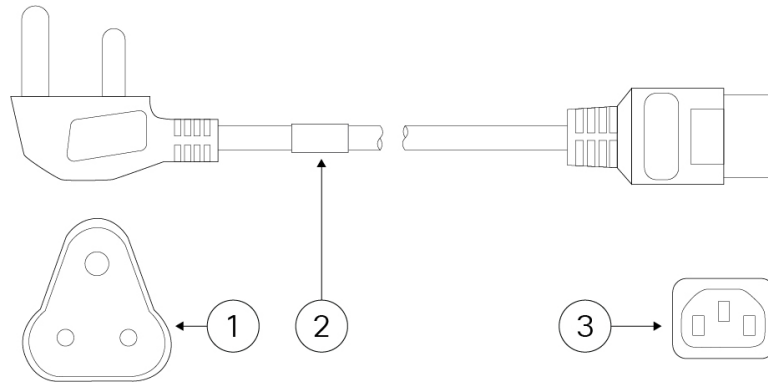
<b>1</b>	Plug: GB2099.1/GB1002	<b>2</b>	Cord set rating: 16 A, 250 V
<b>3</b>	Connector: IEC 60320/C19		

**Figure 22: Europe CAB-AC-2500-EU**



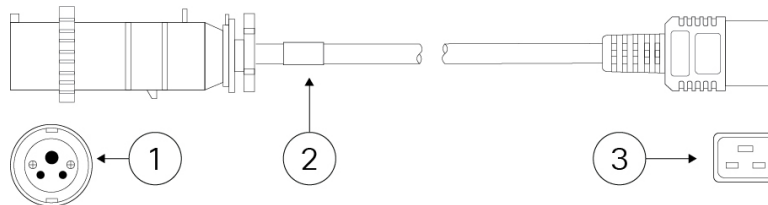
<b>1</b>	Plug: CEE 7 VII	<b>2</b>	Cord set rating: 16 A, 250 V
<b>3</b>	Connector: IEC 60320/C19		

**Figure 23: India CAB-SABS-C19-IND**



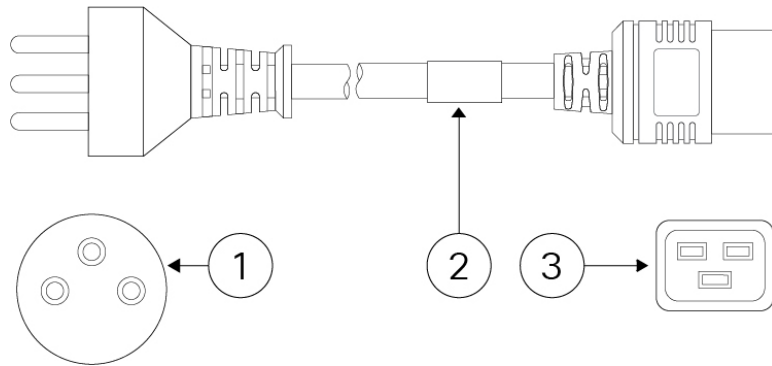
<b>1</b>	Plug: SABS1641:1992	<b>2</b>	Cord set rating: 16 A, 250 V
<b>3</b>	Connector: IEC 60320/C19		

**Figure 24: International CAB-AC-2500W-INT**



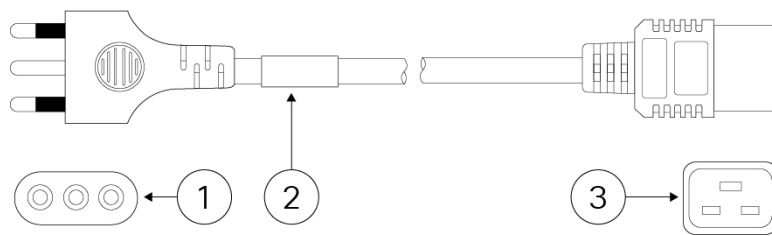
<b>1</b>	Plug: IEC60309/219306	<b>2</b>	Cord set rating: 16 A, 250 V
<b>3</b>	Connector: IEC 60320/C19		

Figure 25: Israel CAB-AC-2500W-ISRL and CAB-S132-C19-ISRL



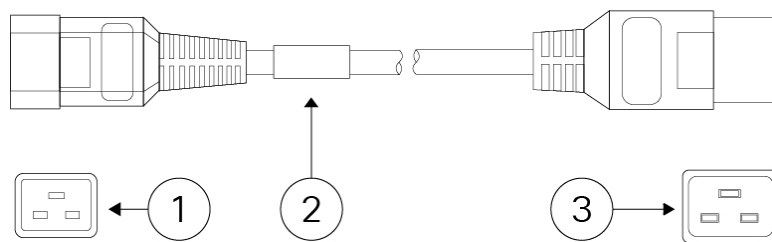
<b>1</b>	Plug: SI 32 PART 1.01	<b>2</b>	Cord set rating: 16 A, 250 V
<b>3</b>	Connector: IEC 60320/C19		

Figure 26: Italy CAB-C2316-C19-IT



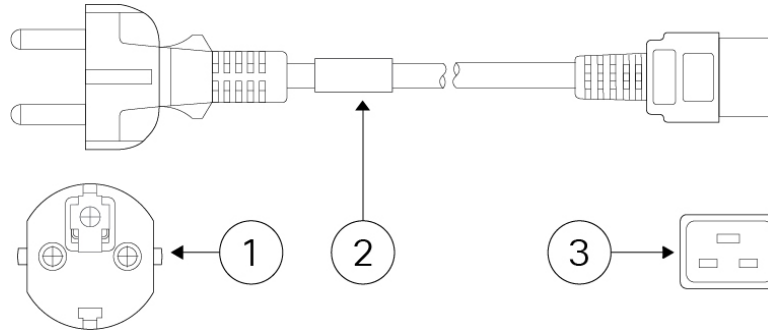
<b>1</b>	Plug: CEI 23-50	<b>2</b>	Cord set rating: 16 A, 250 V
<b>3</b>	Connector: IEC 60320/C19		

Figure 27: Japan CAB-C19-C20-3M-JP



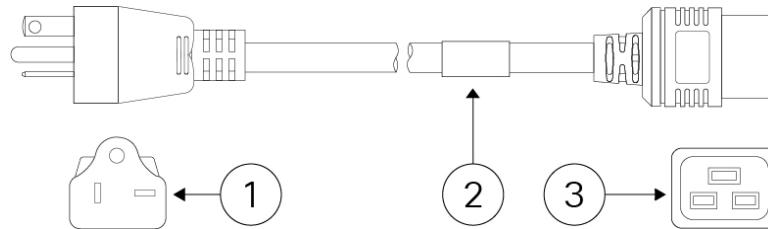
<b>1</b>	Plug: EN 60320-2-2/IC20	<b>2</b>	Cord set rating: 15 A, 250 V
<b>3</b>	Connector: IEC 60320/C19		

**Figure 28: Korea CAB-9K16A-KOR**



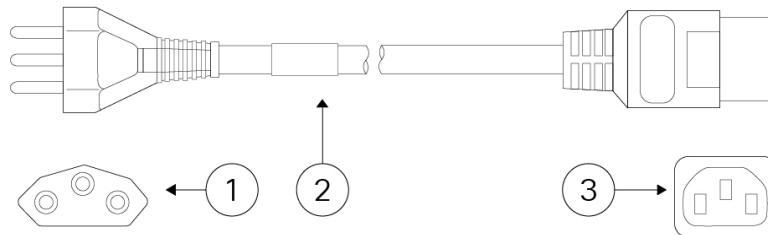
<b>1</b>	Plug: KTL SUO4007-1001	<b>2</b>	Cord set rating: 16 A, 250 V
<b>3</b>	Connector: IEC 60320/C19		

**Figure 29: Molded CAB-US620P-C19-US**



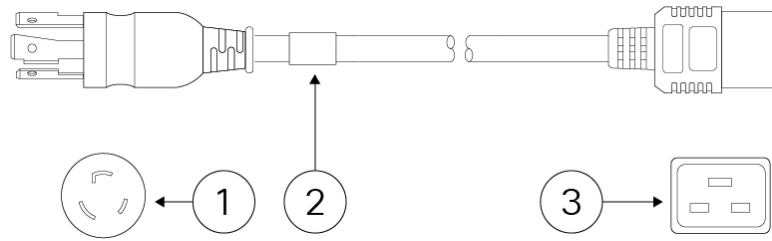
<b>1</b>	Plug: NEMA L6-20P	<b>2</b>	Cord set rating: 16 A, 250 V
<b>3</b>	Connector: IEC 60320/C19		

**Figure 30: Switzerland CAB-ACS-16**



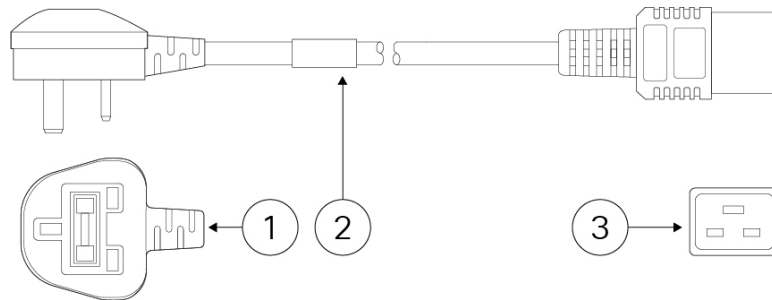
<b>1</b>	Plug: SEV 5934-2	<b>2</b>	Cord set rating: 16 A, 250 V
<b>3</b>	Connector: IEC 60320/C19		

**Figure 31: Twist Lock CAB-AC-C6K-TWLK**



<b>1</b>	Plug: NEMA L6-20P	<b>2</b>	Cord set rating: 16 A, 250 V
<b>3</b>	Connector: IEC 60320/C19		

**Figure 32: United Kingdom CAB-BS1363-C19-UK**



<b>1</b>	Plug: BS1363A	<b>2</b>	Cord set rating: 13 A, 250 V
<b>3</b>	Connector: IEC 60320/C19		



## CHAPTER 2

# Installation Preparation

---

- [General Safety Warnings](#), on page 43
- [Safety Recommendations](#), on page 46
- [Maintain Safety with Electricity](#) , on page 46
- [Prevent ESD Damage](#) , on page 46
- [Site Environment](#), on page 47
- [Site Considerations](#), on page 47
- [Power Supply Considerations](#), on page 47
- [Rack Configuration Considerations](#), on page 48

## General Safety Warnings

Read the [Regulatory and Compliance Safety Information](#) document before installing the Firepower 9300.

Take note of the following general safety warnings:



---

**Warning** **Statement 1071**—Warning Definition

**IMPORTANT SAFETY INSTRUCTIONS**

Before you work on any equipment, be aware of the hazards involved with electrical circuitry and be familiar with standard practices for preventing accidents. Read the installation instructions before using, installing, or connecting the system to the power source. Use the statement number provided at the end of each warning statement to locate its translation in the translated safety warnings for this device.

SAVE THESE INSTRUCTIONS



**Warning Statement 371**—Power Cable and AC Adapter

When installing the product, use the provided or designated connection cables, power cables, AC adapters, and batteries. Using any other cables or adapters could cause a malfunction or a fire. Electrical Appliance and Material Safety Law prohibits the use of UL-certified cables (that have the "UL" or "CSA" shown on the cord), not regulated with the subject law by showing "PSE" on the cord, for any other electrical devices than products designated by Cisco.

**Warning Statement 1005**—Circuit Breaker

This product relies on the building's installation for short-circuit (overcurrent) protection. Ensure that the protective device is rated not greater than: 20 A, 120 V, and 16 A, 250 V

**Note Statement 407**—Japanese Safety Instruction

You are strongly advised to read the safety instruction before using the product.

<https://www.cisco.com/web/JP/techdoc/pldoc/pldoc.html>

When installing the product, use the provided or designated connection cables/power cables/AC adapters.

〈製品仕様における安全上の注意〉  
www.cisco.com/web/JP/techdoc/index.html

接続ケーブル、電源コードセット、ACアダプタ、バッテリーなどの部品は、必ず添付品または指定品をご使用ください。添付品・指定品以外をご使用になると故障や動作不良、火災の原因となります。また、電源コードセットは弊社が指定する製品以外の電気機器には使用できないためご注意ください。

**Warning Statement 1004**—Installation Instructions

Read the installation instructions before using, installing, or connecting the system to the power source.

**Warning Statement 1015**—Battery Handling

To reduce risk of fire, explosion or leakage of flammable liquid or gas:

- Replace the battery only with the same or equivalent type recommended by the manufacturer.
- Do not dismantle, crush, puncture, use sharp tool to remove, short external contacts, or dispose of in fire.
- Do not use if battery is warped or swollen.
- Do not store or use battery in a temperature > 60° C.
- Do not store or use battery in low air pressure environment < 69.7 kPa.





---

**Warning Statement 1029**—Blank Faceplates and Cover Panels

Blank faceplates and cover panels serve three important functions: they reduce the risk of electric shock and fire, they contain electromagnetic interference (EMI) that might disrupt other equipment, and they direct the flow of cooling air through the chassis. Do not operate the system unless all cards, faceplates, front covers, and rear covers are in place.

---



---

**Warning Statement 1030**—Equipment Installation

Only trained and qualified personnel should be allowed to install, replace, or service this equipment.

---



---

**Warning Statement 1040**—Product Disposal

Ultimate disposal of this product should be handled according to all national laws and regulations.

---



---

**Warning Statement 1073**—No User-Serviceable Parts

There are no serviceable parts inside. To avoid risk of electric shock, do not open.

---



---

**Warning Statement 1074**—Comply with Local and National Electrical Codes

To reduce risk of electric shock or fire, installation of the equipment must comply with local and national electrical codes.

---



---

**Warning Statement 1089**—Instructed and Skilled Person Definitions

An instructed person is someone who has been instructed and trained by a skilled person and takes the necessary precautions when working with equipment.

A skilled person or qualified personnel is someone who has training or experience in the equipment technology and understands potential hazards when working with equipment.

---



---

**Warning Statement 1090**—Installation by Skilled Person

Only a skilled person should be allowed to install, replace, or service this equipment. See statement 1089 for the definition of a skilled person.

---



---

**Warning** **Statement 1091**—Installation by an Instructed Person

Only an instructed person or skilled person should be allowed to install, replace, or service this equipment. See statement 1089 for the definition of an instructed or skilled person.

---

## Safety Recommendations

Observe these safety guidelines:

- Keep the area clear and dust-free before, during, and after installation.
- Keep tools away from walkways, where you and others might trip over them.
- Do not wear loose clothing or jewelry, such as earrings, bracelets, or chains that could get caught in the chassis.
- Wear safety glasses if you are working under any conditions that might be hazardous to your eyes.
- Do not perform any action that creates a potential hazard to people or makes the equipment unsafe.
- Never attempt to lift an object that is too heavy for one person.

## Maintain Safety with Electricity



---

**Warning** Before working on a chassis, be sure the power cord is unplugged.

Read the [Regulatory and Compliance Safety Information](#) document before installing the security appliance.

Follow these guidelines when working on equipment powered by electricity:

- Before beginning procedures that require access to the interior of the chassis, locate the emergency power-off switch for the room in which you are working. Then, if an electrical accident occurs, you can act quickly to turn off the power.
- Do not work alone if potentially hazardous conditions exist anywhere in your work space.
- Never assume that power is disconnected; always check.
- Look carefully for possible hazards in your work area, such as moist floors, ungrounded power extension cables, frayed power cords, and missing safety grounds.
- Use the chassis within its marked electrical ratings and product usage instructions.

## Prevent ESD Damage

ESD occurs when electronic components are improperly handled, and it can damage equipment and impair electrical circuitry, resulting in intermittent or complete failure.

Always follow ESD-prevention procedures when removing and replacing components. Ensure that the chassis is electrically connected to an earth ground. Wear an ESD-preventive wrist strap, ensuring that it makes good skin contact. Connect the grounding clip to an unpainted surface of the chassis frame to safely ground ESD voltages. To properly guard against ESD damage and shocks, the wrist strap and cord must operate effectively. If no wrist strap is available, ground yourself by touching the metal part of the chassis.

For safety, periodically check the resistance value of the antistatic strap, which should be between one and 10 megohms.

## Site Environment

See [Hardware Specifications, on page 31](#) for information about physical specifications.

To avoid equipment failures and reduce the possibility of environmentally caused shutdowns, plan the site layout and equipment locations carefully. If you are currently experiencing shutdowns or unusually high error rates with your existing equipment, these considerations may help you isolate the cause of failures and prevent future problems.

## Site Considerations

Considering the following helps you plan an acceptable operating environment for the chassis, and avoid environmentally caused equipment failures.

- Electrical equipment generates heat. Ambient air temperature might not be adequate to cool equipment to acceptable operating temperatures without adequate circulation. Ensure that the room in which you operate your system has adequate air circulation.
- Ensure that the chassis cover is secure. The chassis is designed to allow cooling air to flow effectively within it. An open chassis allows air leaks, which may interrupt and redirect the flow of cooling air from the internal components.
- Always follow the ESD-prevention procedures described previously to avoid damage to equipment. Damage from static discharge can cause immediate or intermittent equipment failure.

## Power Supply Considerations

See [Power Supply Modules, on page 26](#) for more detailed information about the power supply modules in the Firepower 9300 .

When installing the chassis, consider the following:

- Check the power at the site before installing the chassis to ensure that it is “clean” (free of spikes and noise). Install a power conditioner, if necessary, to ensure proper voltages and power levels in the appliance input voltage.
- Install proper grounding for the site to avoid damage from lightning and power surges.
- The chassis does not have a user-selectable operating range. Refer to the label on the chassis for the correct appliance input-power requirement.
- Install an uninterruptible power source for your site, if possible.

- If you are using dual redundant (1+1) power supplies, we recommend that you use independent electrical circuits for each power supply.

## Rack Configuration Considerations

See [Rack-Mount the Chassis, on page 50](#) for the procedure for rack-mounting the chassis.

Consider the following when planning a rack configuration:

- Standard 19-in. (48.3 cm) 4-post EIA rack with mounting rails that conform to English universal hole spacing according to section 1 of ANSI/EIA-310-D-1992.
- The rack-mounting posts need to be 2 to 3.5 mm thick to work with the slide rail rack mounting.
- If you are mounting a chassis in an open rack, make sure that the rack frame does not block the intake or exhaust ports.
- If your rack includes closing front and rear doors, the doors must have 65 percent open perforated area evenly distributed from top to bottom to permit adequate airflow.
- Be sure enclosed racks have adequate ventilation. Make sure that the rack is not overly congested as each chassis generates heat. An enclosed rack should have louvered sides and a fan to provide cooling air.
- In an enclosed rack with a ventilation fan in the top, heat generated by equipment near the bottom of the rack can be drawn upward and into the intake ports of the equipment above it in the rack. Ensure that you provide adequate ventilation for equipment at the bottom of the rack.
- Baffles can help to isolate exhaust air from intake air, which also helps to draw cooling air through the chassis. The best placement of the baffles depends on the airflow patterns in the rack. Experiment with different arrangements to position the baffles effectively.



## CHAPTER 3

# Rack-Mount and Ground the Chassis

---

- [Unpack and Inspect the Chassis, on page 49](#)
- [Rack-Mount the Chassis, on page 50](#)
- [Ground the Chassis, on page 55](#)

## Unpack and Inspect the Chassis



---

**Note** The chassis is thoroughly inspected before shipment. If any damage occurred during transportation or any items are missing, contact your customer service representative immediately. Keep the shipping container in case you need to send the chassis back due to damage.

---

See [Package Contents, on page 6](#) for a list of what shipped with the chassis.

---

- Step 1** Remove the chassis from its cardboard container and save all packaging material.
- Step 2** Compare the shipment to the equipment list provided by your customer service representative. Verify that you have all items.
- Step 3** Check for damage and report any discrepancies or damage to your customer service representative. Have the following information ready:
- Invoice number of shipper (see the packing slip)
  - Model and serial number of the damaged unit
  - Description of damage
  - Effect of damage on the installation
-

# Rack-Mount the Chassis

## Before you begin

The fully populated Firepower 9300 chassis is heavy. For safety concerns, remove the heavy components such as the security modules, power supply modules, and fan modules from the chassis before placing the chassis in the rack. For information on removing Firepower 9300 components, see [Installation, Maintenance, and Upgrade, on page 59](#).

You can mount the Firepower 9300 in a 4-post EIA-310-D rack. The static rail adjusts to fit racks with a 24 to 36-in. span between front and rear rails. The rack-mounting posts need to be 2 to 3.5 mm thick to work with the slide rail rack mounting. The 9300 ships with rack accessories.

The rail kit contains the following:

- Two rails
- Four 10-32 x .-inch screws used to secure the rails to the rack
- Four 10-32 retention nuts for the rack
- Four 10-32 x .75-inch Philips head screws used to secure the system to the rack



---

**Note** You will also need a Phillips head screw driver and the four 10-32-inch screws and retention nuts that came in the Firepower 9300 accessory kit. For information about the accessory kit, see [Package Contents, on page 6](#).

---

## Safety Warnings

Take note of the following rack-mount safety warnings:



---

**Warning Statement 164**—Lifting Requirement

Two people are required to lift the heavy parts of the product. To prevent injury, keep your back straight and lift with your legs, not your back.

---



---

**Warning Statement 1006**—Chassis Warning for Rack-Mounting and Servicing

To prevent bodily injury when mounting or servicing this unit in a rack, you must take special precautions to ensure that the system remains stable. The following guidelines are provided to ensure your safety:

- This unit should be mounted at the bottom of the rack if it is the only unit in the rack.
  - When mounting this unit in a partially filled rack, load the rack from the bottom to the top with the heaviest component at the bottom of the rack.
  - If the rack is provided with stabilizing devices, install the stabilizers before mounting or servicing the unit in the rack.
-




---

**Warning Statement 1032—Lifting the Chassis**

To prevent personal injury or damage to the chassis, never attempt to lift or tilt the chassis using the handles on modules, such as power supplies, fans, or cards. These types of handles are not designed to support the weight of the unit.

---




---

**Warning Statement 1047—Overheating Prevention**

To reduce the risk of fire or bodily injury, do not operate the unit in an area that exceeds the maximum recommended ambient temperature of 104°F (40°C).

---



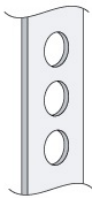
---

**Step 1**

Determine what type of rack you have. You can use the rails in three different rack types. The following figure shows the three rack types:

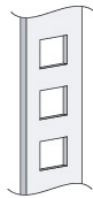
**Figure 33: Round-, Square-, and Threaded-Hole Racks**

Round-hole racks



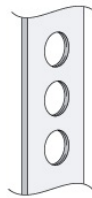
No tools required

Square-hole racks



No tools required

Threaded-hole racks



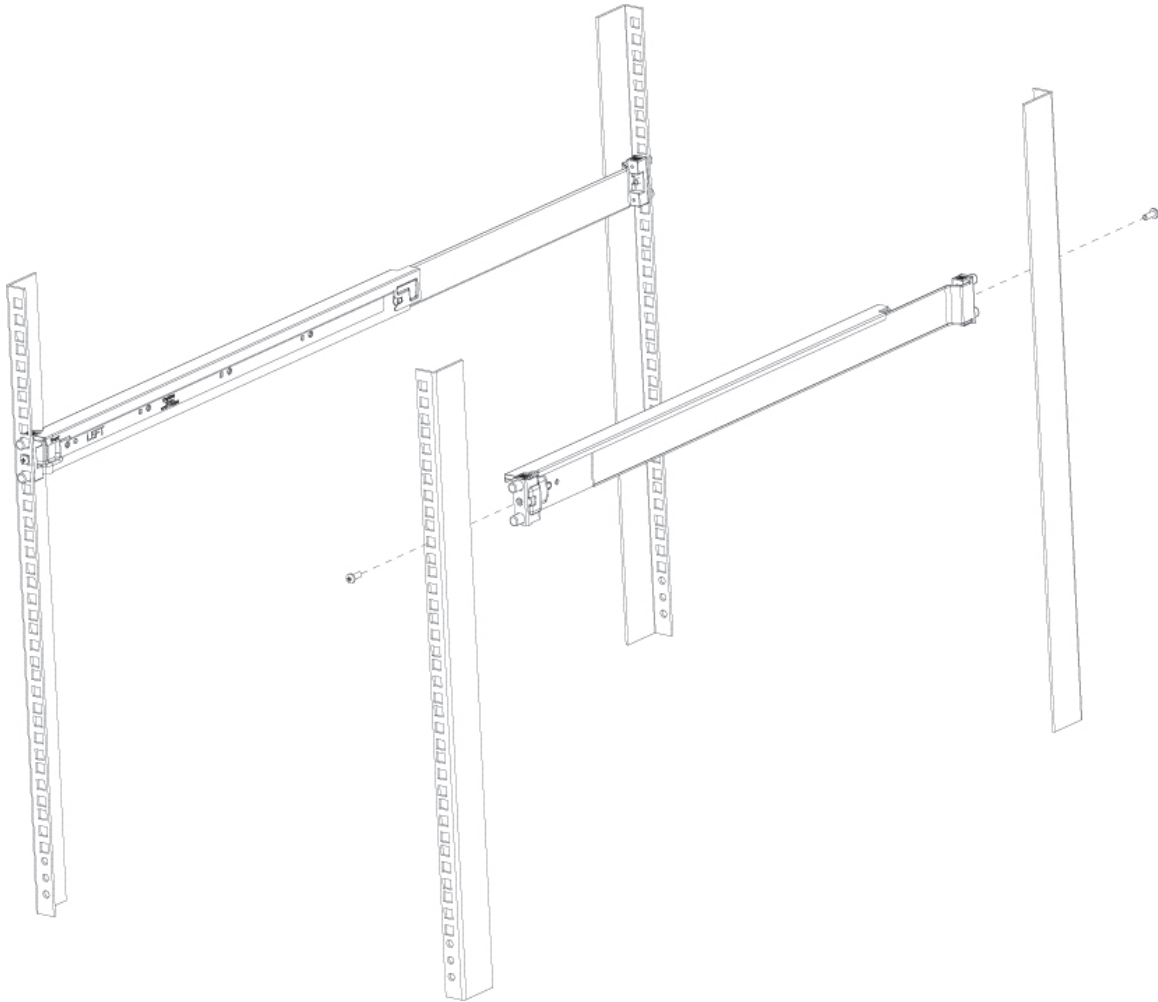
Tools required:  
standard screwdriver,  
Phillips screwdriver,  
or T-25 Torx driver

**Step 2**

Secure the rails to the left and right front posts of the rack by inserting the guide pins into the correct holes. Pull back the round hole casing to expose the guide pins.

Refer to the left/right markings on the rails to make sure you are installing the rails on the correct side of the rack. If your rails do not have left/right markings, make sure that the rails are oriented with the thick part of the rail on top.

**Figure 34: Secure the Left and Right Rails with the Screws**



**Step 3** Press the end of the latch to retract and slide the latch on to the rail.

**Step 4** Repeat Steps 2 and 3 to attach the rails to the rear post of the rack.

**Step 5** Secure the rails to the rack using the four 10-32-inch screws from the rail kit.

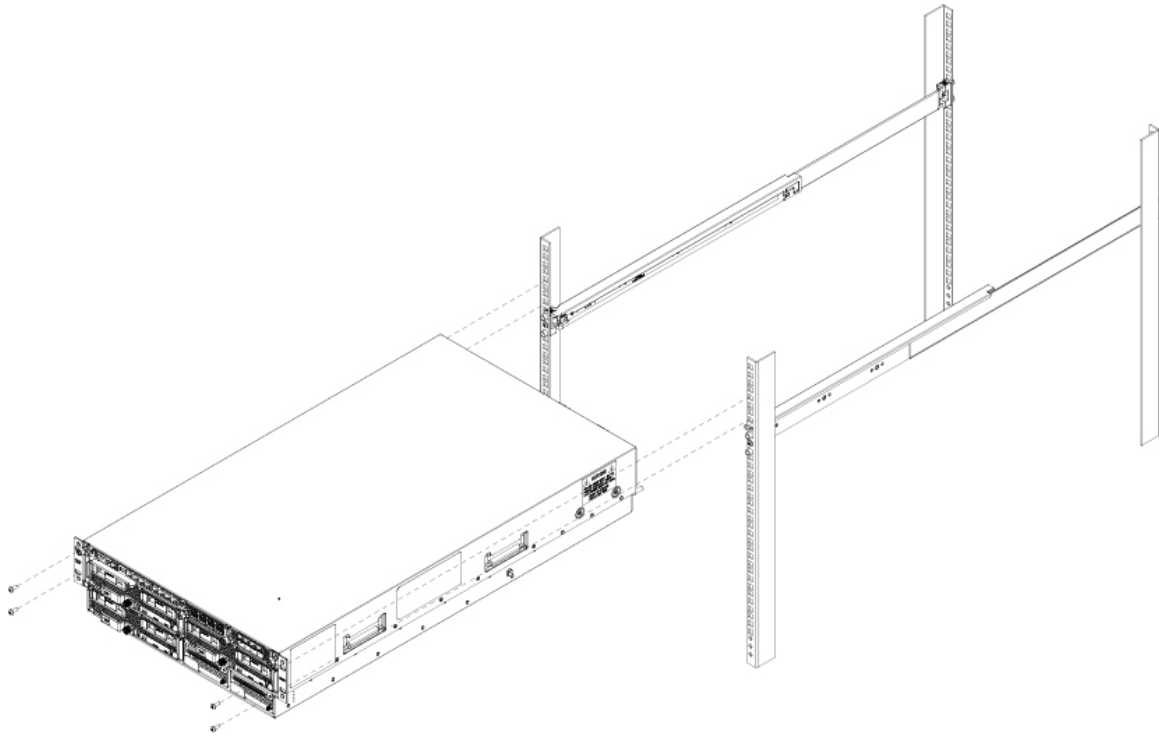
**Note** Depending on your rack type, you may want to install the 4 retention nuts in the rack before sliding the chassis in because the chassis is heavy and it may be difficult to install the retention nuts after the chassis is on the rails.

**Step 6** Set the rear of the empty Firepower 9300 chassis on the static rails.

**Step 7** Carefully push the empty chassis into the rack until the chassis ears sit flush to the rack posts.

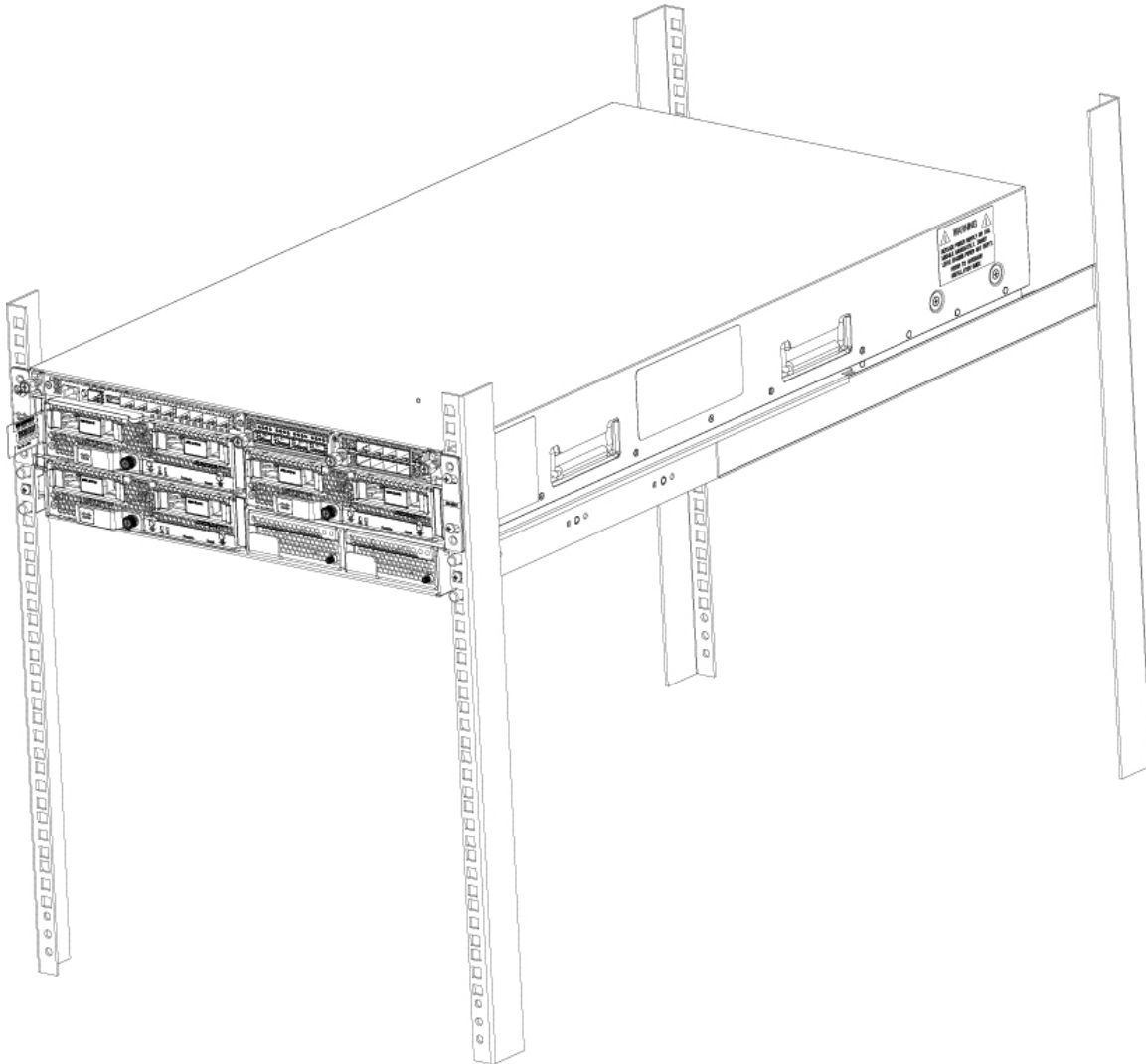


*Figure 35: Push the Rear of the Empty Chassis into the Rack Posts*



- Step 8** Secure the chassis ears to the rack with the four 10-32-inch screws and retention nuts (if you did not already install them in Step 5) that were provided in the Firepower 9300 accessory kit.

Figure 36: Secure Chassis Ears to Rack with Screws



### What to do next

Replace the components that you removed to rack-mount the chassis. For information on replacing Firepower 9300 components, see [Installation, Maintenance, and Upgrade](#), on page 59.

Ground the chassis. See [Ground the Chassis](#), on page 55 for the procedure.

Install the FIPS opacity shield if necessary. See [Install the FIPS Opacity Shield](#), on page 90 for the procedure.

Install the cables according to your default software configuration as described in the [Cisco Firepower 9300 Getting Started Guide](#).

# Ground the Chassis



---

**Note** Grounding the chassis is required, even if the rack is already grounded. A grounding pad with two threaded M4 holes is provided on the chassis for attaching a grounding lug. The grounding lug must be Nationally Recognized Testing Laboratory (NRTL)-listed. In addition, a copper conductor (wires) must be used and the copper conductor must comply with National Electrical Code (NEC) code for ampacity.

---

You need the following items that you provide:

- Wire-stripping tool
- Crimping tool
- Grounding cable
- Two star lock washers for the 10-32 x 0.375-inch screws used to secure the ground lug
- You need the following items from the accessory kit:
  - Grounding lug #6 AWG, 90 degree, #10 post
  - Two 10-32 x 0.375-inch screws used to secure the grounding lug

## Safety Warnings

Take note of the following ground connection warnings:



---

**Warning** **Statement 1024**—Ground Conductor

This equipment must be grounded. To reduce the risk of electric shock, never defeat the ground conductor or operate the equipment in the absence of a suitably installed ground conductor. Contact the appropriate electrical inspection authority or an electrician if you are uncertain that suitable grounding is available.

---



---

**Warning** **Statement 1025**—Use Copper Conductors Only

To reduce risk of fire, use copper conductors only.

---



---

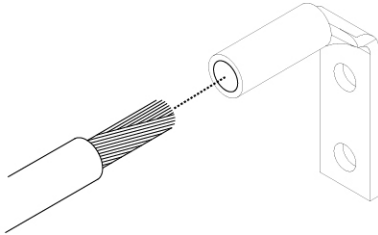
**Warning** **Statement 1052**—Installing and Grounding the Antenna

To reduce the risk of electric shock, refer to national and local codes for proper installation and grounding of antennas.

---

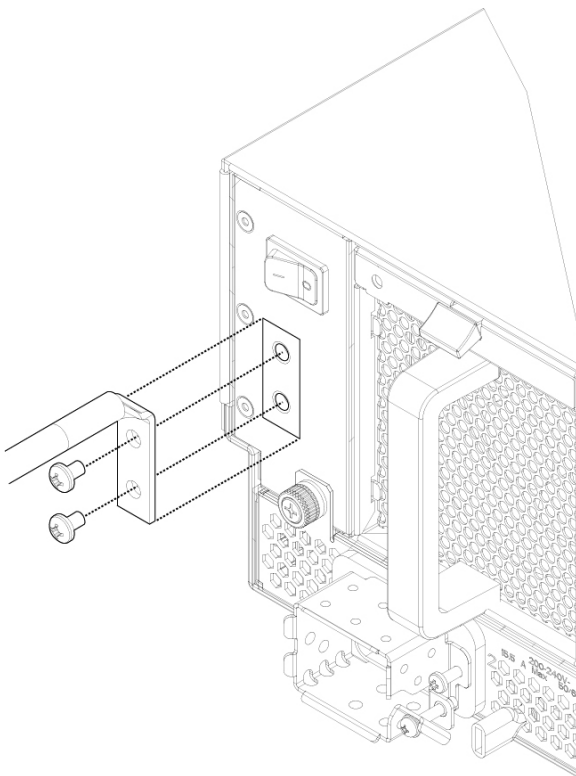
- Step 1** Use a wire-stripping tool to remove approximately 0.75 inches (19 mm) of the covering from the end of the grounding cable.
- Step 2** Insert the stripped end of the grounding cable into the open end of the grounding lug.

*Figure 37: Insert the Cable into the Grounding Lug*



- Step 3** Use the crimping tool to secure the grounding cable in the grounding lug.
- Step 4** Remove the adhesive label from the grounding pad on the chassis.
- Step 5** Place the grounding lug against the grounding pad so that there is solid metal-to-metal contact, and insert the two screws with washers through the holes in the grounding lug and into the grounding pad.

*Figure 38: Attach the Grounding Lug*



- Step 6** Make sure that the lug and cable do not interfere with other equipment.

- Step 7** Prepare the other end of the grounding cable and connect it to an appropriate grounding point in your site to ensure adequate earth ground.
- 

**What to do next**

Install the FIPS opacity shield if necessary. See [Install the FIPS Opacity Shield, on page 90](#) for the procedure.

Install the cables according to your default software configuration as described in the [Cisco Firepower 9300 Getting Started Guide](#).





## CHAPTER 4

# Installation, Maintenance, and Upgrade

- [Remove and Replace the Supervisor, on page 59](#)
- [Install, Remove, and Replace the Security Module, on page 61](#)
- [Remove and Replace the SSD, on page 64](#)
- [Install, Remove, and Replace the Single-Wide Network Module, on page 66](#)
- [Install, Remove, and Replace the Double-Wide Network Module, on page 71](#)
- [Remove and Replace the Power Supply Module, on page 75](#)
- [Connect the DC Power Supply Module, on page 80](#)
- [Connect the HVDC Power Supply Module, on page 83](#)
- [Remove and Replace the Fan Module, on page 87](#)
- [Install the FIPS Opacity Shield, on page 90](#)

## Remove and Replace the Supervisor

You can remove the Firepower 9300 Supervisor while the system is powered on without damage to the Supervisor hardware or system. However, because the supervisor is controlling the entire chassis, including the power system, we recommend that you use the power switch on the rear panel of the chassis to put the system in standby mode. See [Supervisor, on page 11](#) for more information about the Supervisor.

### Safety Warnings

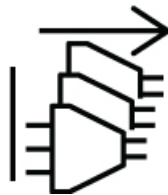
Take note of the following component replacement safety warnings:



---

**Warning** **Statement 1028**—More Than One Power Supply

This unit might have more than one power supply connection. To reduce risk of electric shock, remove all connections to de-energize the unit.



**Warning Statement 1030**—Equipment Installation

Only trained and qualified personnel should be allowed to install, replace, or service this equipment.

**Warning Statement 1073**—No User-Serviceable Parts

There are no serviceable parts inside. To avoid risk of electric shock, do not open.

**Warning Statement 1089**—Instructed and Skilled Person Definitions

An instructed person is someone who has been instructed and trained by a skilled person and takes the necessary precautions when working with equipment.

A skilled person or qualified personnel is someone who has training or experience in the equipment technology and understands potential hazards when working with equipment.

**Warning Statement 1090**—Installation by Skilled Person

Only a skilled person should be allowed to install, replace, or service this equipment. See statement 1089 for the definition of a skilled person.

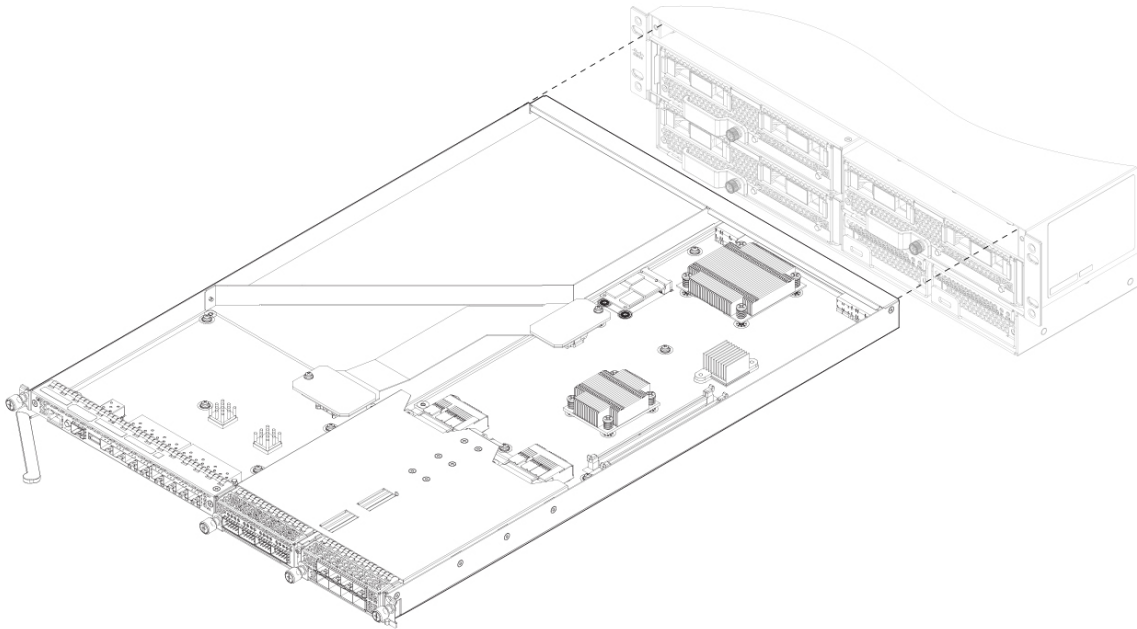
**Warning Statement 1091**—Installation by an Instructed Person

Only an instructed person or skilled person should be allowed to install, replace, or service this equipment. See statement 1089 for the definition of an instructed or skilled person.

- 
- Step 1** To remove the Supervisor, loosen the two captive screws on the Supervisor tray.
- Step 2** Remove the Supervisor tray from the chassis by pulling the handle on the Supervisor until it is unseated.
- Step 3** Slide the tray partway out of the chassis, place your other hand under the tray to support its weight, and remove it from the chassis.



**Figure 39: Remove and Replace the Supervisor**



- Step 4** To install a new Supervisor tray, grasp the front of the tray and place your other hand under the tray to support it.
- Step 5** Open the handle on the front of the tray.
- Step 6** Gently slide the tray into the opening until you cannot push it any farther.
- Step 7** Press the handle so that it catches the edge of the chassis and presses the tray all the way in.
- Step 8** When the tray is all the way in the chassis, push in the handle to fully seat the tray.
- Step 9** Using your fingers, tighten the captive screw on the front of the Supervisor; if using a screw driver, tighten to no more than 3 in-lbs.  
Tightening the captive screws with your fingers is unlikely to lead to stripped or damaged captive screws.

## Install, Remove, and Replace the Security Module

This procedure describes how to install a security module into an empty slot that has never contained a security module, and how to remove an installed security module and replace it with another security module.

You can remove the Firepower 9300 security module while the system is running, but we recommend that you use the power switch on the rear of the chassis to put the security module in standby mode before removal and reinstallation. If you install a new service module in an empty slot, you do not need to power off the system.



**Note** Make sure you have the correct firmware package and software version installed to support your security module. For instructions on how to verify your firmware package version and to upgrade the firmware if necessary, see the [Cisco Firepower 4100/9300 FXOS Firmware Upgrade Guide](#). See [Cisco Firepower 4100/9300 FXOS Compatibility](#) for the software compatibility matrix.



**Caution** If you want to replace an existing security module with another security module, you must decommission the old security module before removing it. See the "Security Module/Engine Management" chapter in the [Cisco FXOS Firepower Chassis Manager Configuration Guide](#) for the instructions. After you decommission the old security module, you can remove it, install the new security module, have the system acknowledge it, and then reinitialize it.

### Safety Warnings

Take note of the following component replacement safety warnings:



#### **Warning** Statement 1028—More Than One Power Supply

This unit might have more than one power supply connection. To reduce risk of electric shock, remove all connections to de-energize the unit.



#### **Warning** Statement 1030—Equipment Installation

Only trained and qualified personnel should be allowed to install, replace, or service this equipment.



#### **Warning** Statement 1073—No User-Serviceable Parts

There are no serviceable parts inside. To avoid risk of electric shock, do not open.



#### **Warning** Statement 1089—Instructed and Skilled Person Definitions

An instructed person is someone who has been instructed and trained by a skilled person and takes the necessary precautions when working with equipment.

A skilled person or qualified personnel is someone who has training or experience in the equipment technology and understands potential hazards when working with equipment.



#### **Warning** Statement 1090—Installation by Skilled Person

Only a skilled person should be allowed to install, replace, or service this equipment. See statement 1089 for the definition of a skilled person.

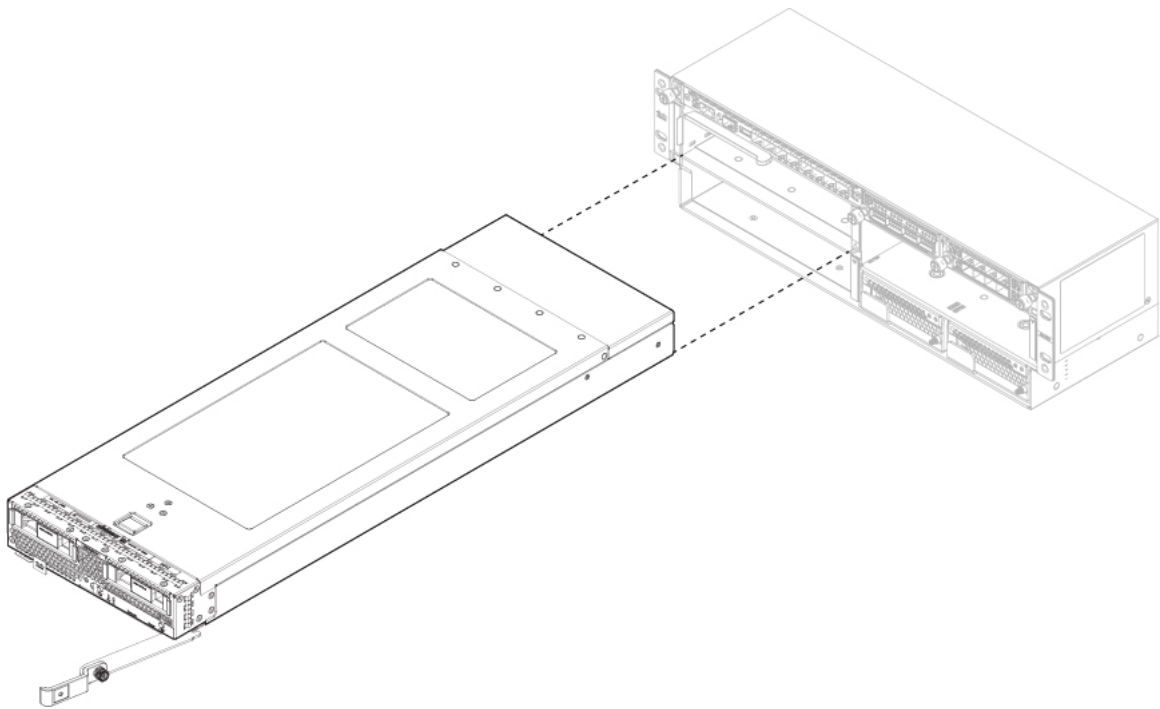


**Warning Statement 1091**—Installation by an Instructed Person

Only an instructed person or skilled person should be allowed to install, replace, or service this equipment. See statement 1089 for the definition of an instructed or skilled person.

- Step 1** To install a new security module for the first time into an empty slot, do the following:
- Follow steps 6 through 10.
  - Enter **scope slot > acknowledge** to bring the new security module online.
- Step 2** To remove a security module, loosen the captive screw on the front of the security module.
- Step 3** Remove the security module from the chassis by pulling the handle on the security module until it is unseated.
- Step 4** Slide the security module partway out of the chassis, place your other hand under the security module to support its weight, and remove it from the chassis.

*Figure 40: Remove and Install the Security Module*



- Step 5** Place the security module on an antistatic mat or antistatic foam if you are not immediately reinstalling it in another slot.  
If the slot is to remain empty, install a blank faceplate to ensure proper airflow and to keep dust out of the chassis; otherwise install another security module.
- Step 6** To install a new security module, grasp the front of the security module and place your other hand under the security module to support it.
- Step 7** Open the handle in the front of the security module.
- Step 8** Gently slide the security module into the opening until you cannot push it any farther.
- Step 9** Press the handle so that it catches the edge of the chassis and presses the security module all the way in.

- Step 10** Using your fingers, tighten the captive screw on the front of the security module; if using a screw driver, tighten to no more than 3 in-lbs.  
Tightening the captive screws with your fingers is unlikely to lead to stripped or damaged captive screws.

## Remove and Replace the SSD

There are two SSDs in each security module. They are configured in a RAID 1 configuration. If one or both SSDs fail, you must decommission the security module and acknowledge the slot to start the SSD installation and update the inventory. See the "Security Module/Engine Management" chapter in the [Cisco FXOS Firepower Chassis Manager Configuration Guide](#) for the instructions. After you decommission the security module, you can remove the SSDs, install the new SSDs, and acknowledge the slot to bring the security module back online.



**Note** Once you replace the SSD, the storage controller rebuilds the newly installed SSD and no loss of data should occur. If both SSDs fail, no data can be recovered.



**Note** The two SSDs in RAID 1 store each other's data. Breaking the RAID pair to use in another service module causes the service module to fail discovery by the Supervisor.

### Safety Warnings

Take note of the following warnings:



**Warning Statement 1028**—More Than One Power Supply

This unit might have more than one power supply connection. To reduce risk of electric shock, remove all connections to de-energize the unit.



**Warning Statement 1030**—Equipment Installation

Only trained and qualified personnel should be allowed to install, replace, or service this equipment.



---

**Warning** **Statement 1073**—No User-Serviceable Parts

There are no serviceable parts inside. To avoid risk of electric shock, do not open.

---



---

**Warning** **Statement 1089**—Instructed and Skilled Person Definitions

An instructed person is someone who has been instructed and trained by a skilled person and takes the necessary precautions when working with equipment.

A skilled person or qualified personnel is someone who has training or experience in the equipment technology and understands potential hazards when working with equipment.

---



---

**Warning** **Statement 1090**—Installation by Skilled Person

Only a skilled person should be allowed to install, replace, or service this equipment. See statement 1089 for the definition of a skilled person.

---



---

**Warning** **Statement 1091**—Installation by an Instructed Person

Only an instructed person or skilled person should be allowed to install, replace, or service this equipment. See statement 1089 for the definition of an instructed or skilled person.

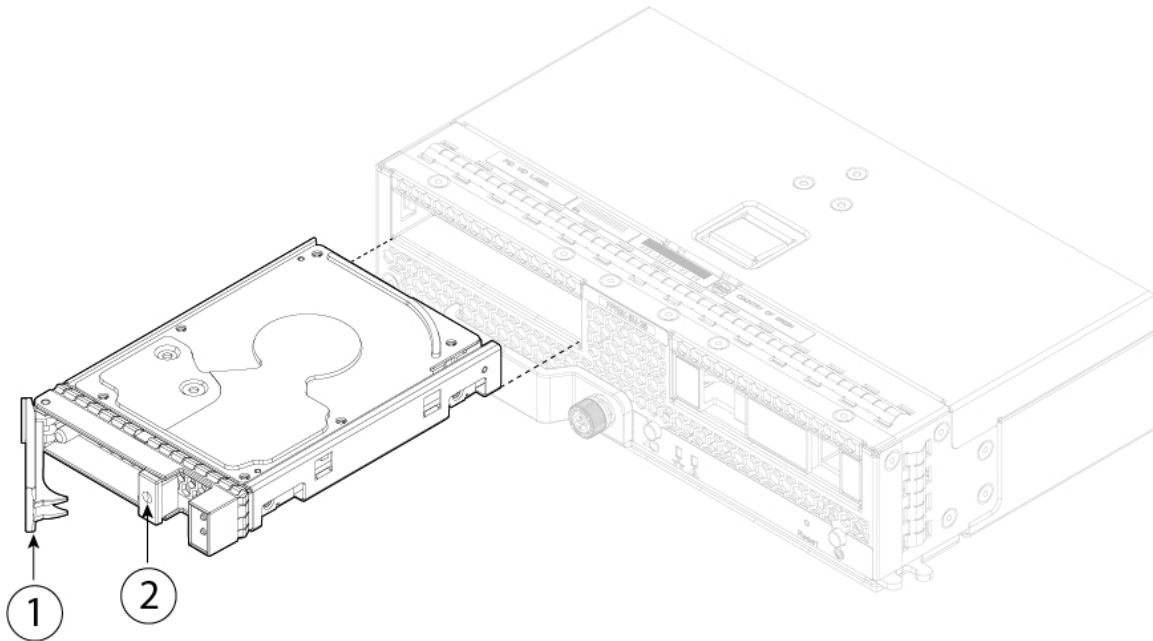
---

---

**Step 1** Decommission the security module.

**Step 2** To remove an SSD, face the front of the chassis, press the handle release on the SSD and gently pull it out of the slot.

Figure 41: Remove the SSD



1	Handle	2	Handle release
---	--------	---	----------------

- Step 3** To replace the SSD, hold the SSD in front of slot 1, push it in gently until it is seated, and close the handle.
- Step 4** Tighten the captive screws on either side of the SSD.
- Step 5** Acknowledge the slot to start the SSD installation.

## Install, Remove, and Replace the Single-Wide Network Module

This procedure describes how to install a network module into an empty slot that has never contained a network module, and how to remove an installed network module and replace it with another network module.

### Hot Swapping

Verify that you have the correct software to support hot swapping on the Firepower 10-Gb and 40-Gb nonhardware bypass network modules. See [Cisco Firepower 4100/9300 FXOS Compatibility](#) for the software compatibility matrix. You must hot swap with an identical network module, that is, a network module with the same PID. See [Product ID Numbers, on page 33](#) for a list of the network module PIDs. You must bring the network module offline using the appropriate CLI commands before removing the network module from the chassis so that all network module configuration is saved.



**Caution** We do not recommend that you remove the network module without bringing it properly offline using the appropriate CLI commands.



**Note** Verify that you have the correct ROMMON on the Supervisor to support hot swapping. For instructions on how to verify your firmware package version and to upgrade the firmware if necessary, see the [Cisco Firepower 4100/9300 FXOS Firmware Upgrade Guide](#).

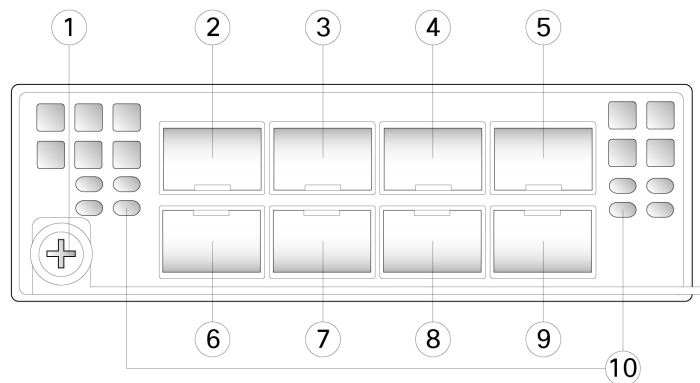
To remove and replace the network modules that do *not* currently support hot swapping, power off the chassis, replace the network module, and then power the chassis back on.



**Note** Verify that you have the correct ROMMON on the Supervisor to support the 100-Gb network modules (FPR9K-NM-4X100G and FPR9K-NM-2X100G). For instructions on how to verify your firmware package version and to upgrade the firmware if necessary, see the [Cisco Firepower 4100/9300 FXOS Firmware Upgrade Guide](#).

The following figure shows the front panel of the 10-Gb nonhardware bypass network module. The location of the captive screw, ports, and LEDs is shown. See [Network Modules](#), on page 16 for more information about the other single-wide network modules.

**Figure 42: Firepower Network Module 10 Gb**



<b>1</b>	Captive screw/handle	<b>2</b>	Ethernet X/1
<b>3</b>	Ethernet X/3	<b>4</b>	Ethernet X/5
<b>5</b>	Ethernet X/7	<b>6</b>	Ethernet X/2
<b>7</b>	Ethernet X/4	<b>8</b>	Ethernet X/6
<b>9</b>	Ethernet X/8	<b>10</b>	Network activity LEDs <ul style="list-style-type: none"> <li>• Off—No connection or port is not in use.</li> <li>• Amber—No link or network failure.</li> <li>• Green—Link up.</li> <li>• Green, flashing—Network activity.</li> </ul>

### Safety Warnings

Take note of the following component replacement safety warnings:




---

**Warning Statement 1028—More Than One Power Supply**

This unit might have more than one power supply connection. To reduce risk of electric shock, remove all connections to de-energize the unit.




---

**Warning Statement 1030—Equipment Installation**

Only trained and qualified personnel should be allowed to install, replace, or service this equipment.




---

**Warning Statement 1073—No User-Serviceable Parts**

There are no serviceable parts inside. To avoid risk of electric shock, do not open.




---

**Warning Statement 1089—Instructed and Skilled Person Definitions**

An instructed person is someone who has been instructed and trained by a skilled person and takes the necessary precautions when working with equipment.

A skilled person or qualified personnel is someone who has training or experience in the equipment technology and understands potential hazards when working with equipment.




---

**Warning Statement 1090—Installation by Skilled Person**

Only a skilled person should be allowed to install, replace, or service this equipment. See statement 1089 for the definition of a skilled person.




---

**Warning Statement 1091—Installation by an Instructed Person**

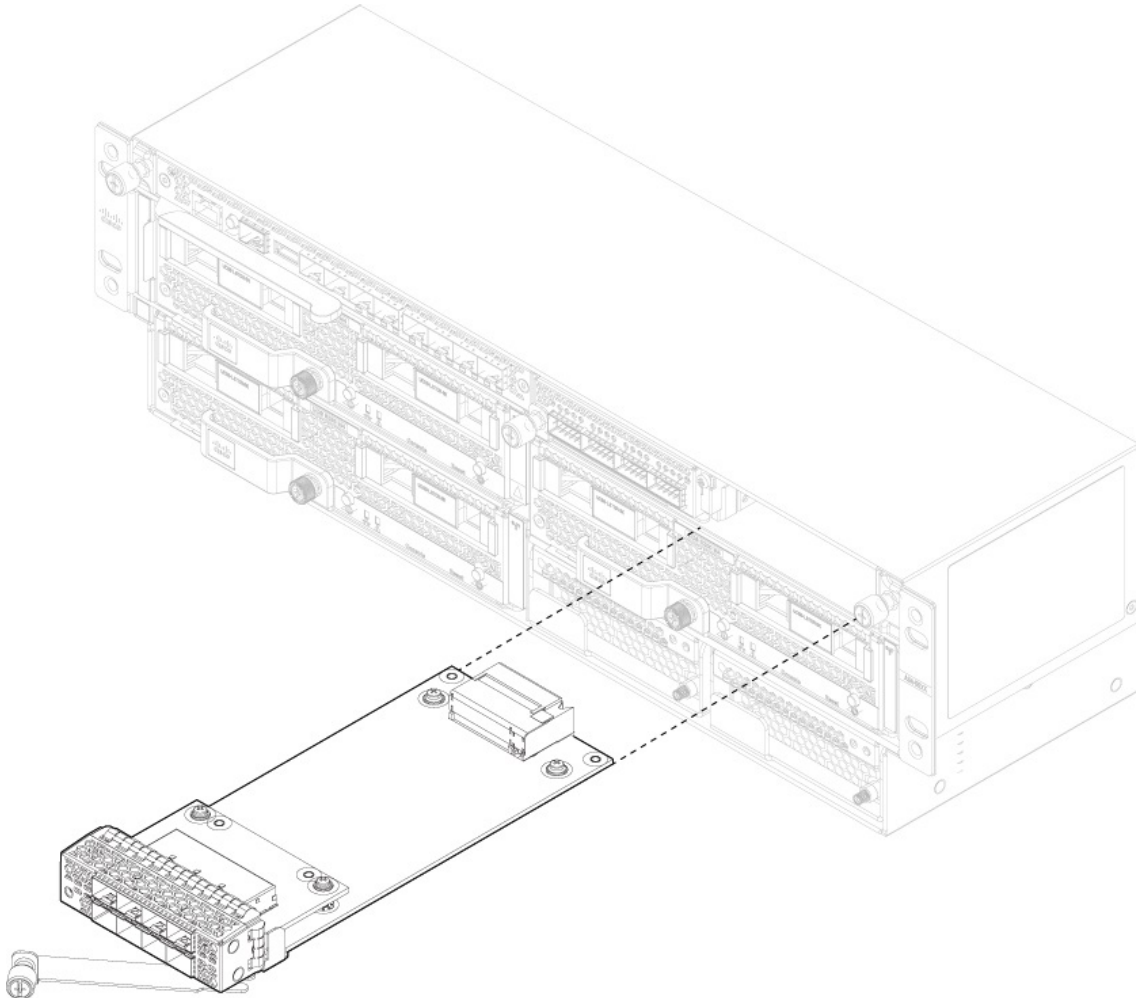
Only an instructed person or skilled person should be allowed to install, replace, or service this equipment. See statement 1089 for the definition of an instructed or skilled person.

---



- 
- Step 1** To install a new network module for the first time into an empty slot, do the following:
- Power down the chassis by moving the power switch to the OFF position.
  - Follow Steps 5 through 7 to install the new network module.
  - Power on the chassis by moving the power switch to the ON position.  
The state for the new network module is `OIR Failed`.
  - To change the status of the network module to `Online`, reboot the chassis. See the "Rebooting the Firepower 4100/9300 Chassis" topic in the System Administration chapter in the [FXOS Configuration Guide](#) for your software version.
- Step 2** To remove and replace an existing network module, do one of the following:
- Save your configuration.
  - Power down the chassis by moving the power switch to the OFF position (if removing a network module that does *not* support hot swapping).
  - Bring the network module offline using the appropriate CLI command (if removing a network module that *supports* hot swapping). All network module configuration is saved. See the "Taking a Network Module Offline or Online" topic in the Security Module/Engine Management chapter in the [FXOS Configuration Guide](#) for your software version.
  - Continue with Step 3.
- Step 3** To remove the network module, loosen the captive screw on the left of the network module, release the handle until it is fully rotated, and then gently pull the network module out of the chassis.

**Figure 43: Remove and Replace the Single-Wide Network Module**



If the slot is to remain empty, install a blank faceplate to ensure proper airflow and to keep dust out of the chassis; otherwise, install another network module.

**Step 4** (Optional) If you are installing a single-wide network module into a double-wide slot, you must install a divider. The blank faceplates are for a single slot, so install the divider if you are covering two single network slots.

**Note** The original 9300 chassis and the newer 9300 chassis have different dividers. You can order FPR9K-NM-DIV=, which contains a screw and both dividers in case you have lost the divider (part number 800-101936-01) for the older chassis or you need the new divider (part number 700-112465-01) for the newer chassis.

**Step 5** To install a new network module, hold the network module in front of the network module slot on the right side of the chassis with the handle fully extended. Slowly push the module into the network module slot until the handle catches on the mating feature in the chassis. The handle should engage correctly.

**Step 6** Gently push on the handle until it is fully seated on the network module faceplate and the module is fully seated in the chassis.

**Step 7** Tighten the captive screw on the left of the network module.

**Step 8** Do one of the following:

- a) Power up the chassis so that the new network module is recognized (if the new network module does *not* support hot swapping).
- b) Bring the new network module online using the appropriate CLI command (if the new network module *supports* hot swapping). The saved network module configuration is automatically reapplied when the network module is back online.

**Note** If you install a network module that is a different PID than the original network module, the saved configuration is deleted and the default configuration is applied. You must enter the **acknowledge** command to confirm the network module PID change.

Follow the procedures in the [FXOS Configuration Guide](#) to connect to the network module and make sure that it has been discovered correctly by the Firepower 9300.

---

## Install, Remove, and Replace the Double-Wide Network Module

This procedure describes how to install a network module into an empty slot that has never contained a network module, and how to remove an installed network module and replace it with another network module.



---

**Note** Make sure your Firepower 9300 has the correct firmware package installed before you install the Firepower 100-Gb network module. For instructions on how to verify your firmware package version and to upgrade the firmware if necessary, see the [Cisco Firepower 4100/9300 FXOS Firmware Upgrade Guide](#).

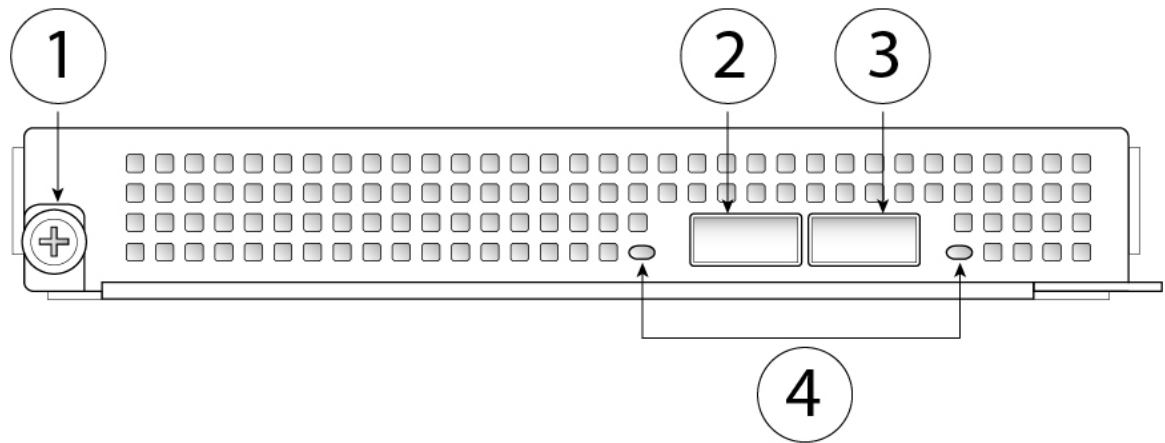
---

The Firepower 100-Gb network module is an optional, removable I/O module that provides two fiber 100 Gigabit Ethernet interfaces. It takes up two slots in the Firepower 9300 and supports single and multimode.

Verify that your software supports hot swapping. See [Cisco Firepower 4100/9300 FXOS Compatibility](#) for the software compatibility matrix. After removing and replacing the network module, you must reboot the system so that the Firepower 9300 discovers the new network module. See [Network Modules, on page 16](#) for more information about Firepower 9300 network modules.

The following figure shows the front panel view of the Firepower 9300 100-Gb network module.

Figure 44: 100-Gb Network Module



1	Captive screw on handle	2	100-Gigabit Ethernet QSFP28 fiber port Ethernet X/1
3	100-Gigabit Ethernet QSFP28 fiber port Ethernet X/2	4	Network activity LEDs <ul style="list-style-type: none"> <li>• Off—No connection or port is not in use.</li> <li>• Amber—No link or network failure.</li> <li>• Green, flashing—Network activity.</li> </ul>

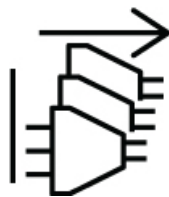
### Safety Warnings

Take note of the following component replacement safety warnings:



#### Warning Statement 1028—More Than One Power Supply

This unit might have more than one power supply connection. To reduce risk of electric shock, remove all connections to de-energize the unit.



#### Warning Statement 1030—Equipment Installation

Only trained and qualified personnel should be allowed to install, replace, or service this equipment.

**Warning Statement 1073**—No User-Serviceable Parts

There are no serviceable parts inside. To avoid risk of electric shock, do not open.

**Warning Statement 1089**—Instructed and Skilled Person Definitions

An instructed person is someone who has been instructed and trained by a skilled person and takes the necessary precautions when working with equipment.

A skilled person or qualified personnel is someone who has training or experience in the equipment technology and understands potential hazards when working with equipment.

**Warning Statement 1090**—Installation by Skilled Person

Only a skilled person should be allowed to install, replace, or service this equipment. See statement 1089 for the definition of a skilled person.

**Warning Statement 1091**—Installation by an Instructed Person

Only an instructed person or skilled person should be allowed to install, replace, or service this equipment. See statement 1089 for the definition of an instructed or skilled person.

**Step 1**

To install a new network module for the first time into an empty slot, do the following:

- a) Power down the chassis by moving the power switch to the OFF position.
- b) Follow Steps 4 through 6 to install the new network module.
- c) Power on the chassis by moving the power switch to the ON position.

The state for the new network module is `OIR Failed`.

- d) To change the status of the network module to `Online`, reboot the chassis. See the "Rebooting the Firepower 4100/9300 Chassis" topic in the System Administration chapter in the [FXOS Configuration Guide](#) for your software version.

**Step 2**

To remove and replace an existing network module, do one of the following:

- a) Save your configuration.
- b) Power down the chassis by moving the power switch to the OFF position.
- c) Continue with Step 3.

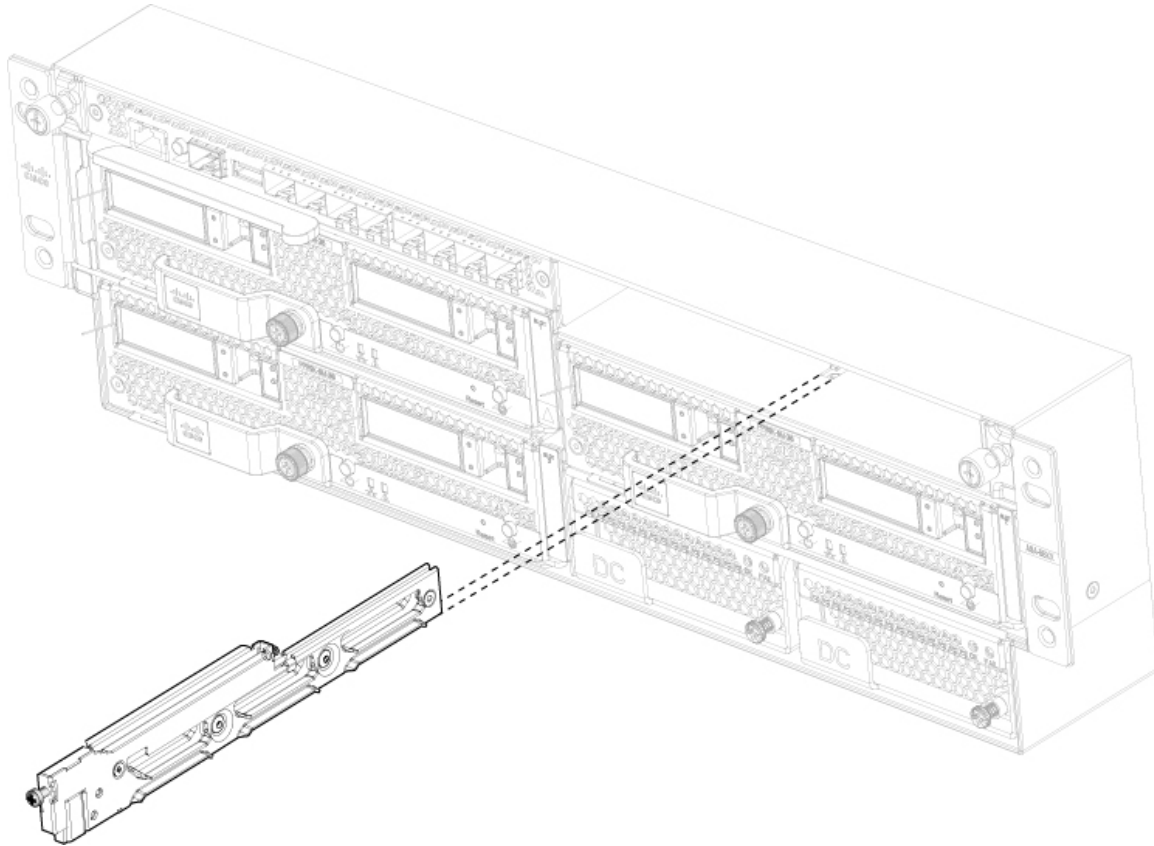
**Step 3**

Do one of the following:

- a) If you are removing single-wide network modules installed in the two network module slots, loosen the captive screw on the left of the network modules, release the handles, and then gently pull the network modules out of the chassis. Remove the divider between the two network modules by loosening the captive screw at the top of the divider and then pull it out.

**Note** Save the divider in case you ever want to replace the 100-Gb double-wide network module with one or two single-wide network modules. Or you can order the divider kit (FPR9K-NM-DIV=), which contains two dividers, one for the original 9300 chassis and one for the newer 9300 chassis.

**Figure 45: Remove the Network Module Divider**



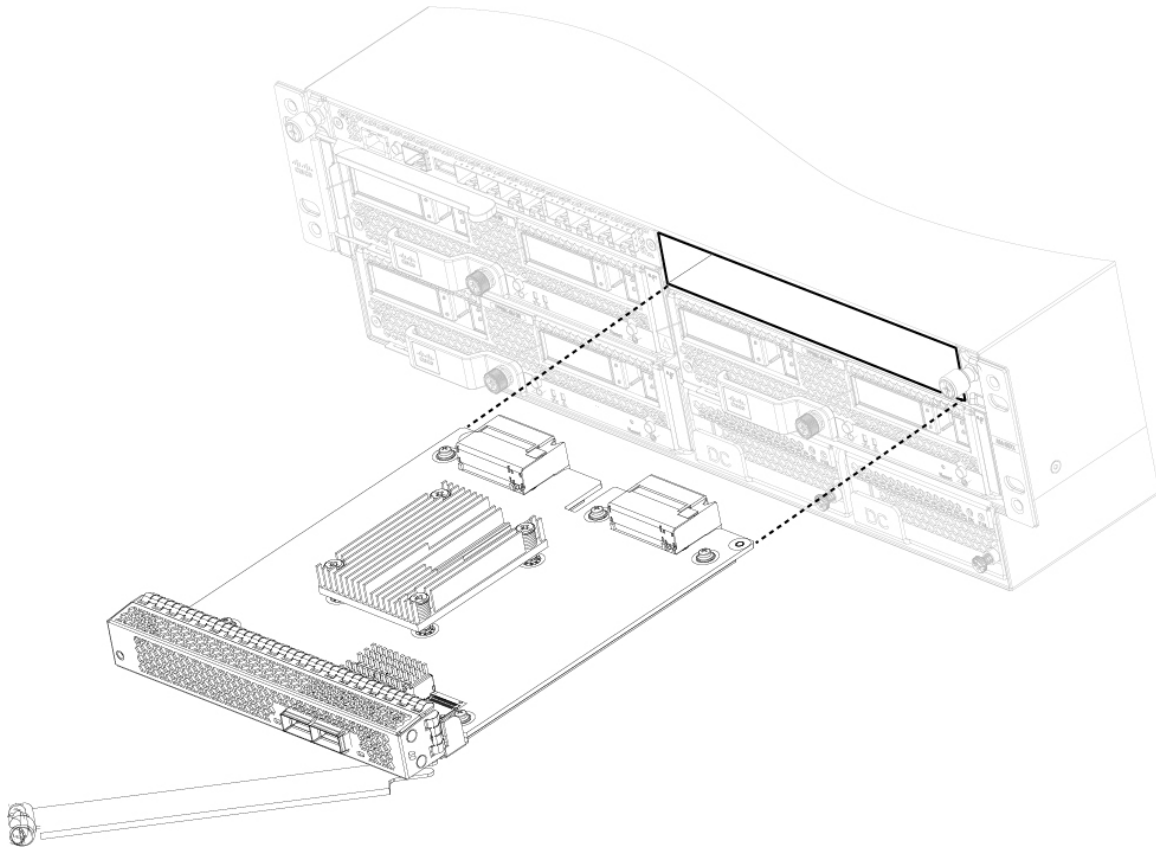
- b) If you are removing a 100-Gb network module, loosen the captive screw on the left of the module, release the handle, and gently pull it out.

If the slot is to remain empty, install a blank faceplate to ensure proper airflow and to keep dust out of the chassis; otherwise, install another network module. The blank faceplates are for a single slot, so install the divider if you are covering two single network slots.

**Step 4**

Hold the 100-Gb network module in front of the double network module slot on the right side of the chassis with the handle rotated fully out. Slowly push the module into the network module slot until the handle catches on the mating feature in the chassis. The handle should engage correctly.

Figure 46: Install the 100-Gb Network Module



- Step 5** Gently push on the handle until it is fully seated on the network module faceplate and the module is fully seated in the chassis.
- Step 6** Tighten the captive screw on the left of the network module.
- Step 7** Power on the chassis so that the new network module is recognized.
- Follow the procedures in the [FXOS Configuration Guide](#) to connect to the network module and make sure that it has been discovered correctly by the Firepower 9300.

## Remove and Replace the Power Supply Module

You can remove and replace the power supply module while the system is running. Make sure that at least one of the power supply modules is active while hot-swapping.



**Note** Replace power supplies immediately. Power supply blanks are not available.

### Safety Warnings

Take note of the following power and component removal safety warnings:




---

**Warning Statement 347—Failure to Secure the Expansion Module**

To reduce the risk of electric shock, secure the modules with the provided screws.

---




---

**Warning Statement 1003—DC Power Disconnection**

Before performing any of the following procedures, ensure that power is removed from the DC circuit.

---




---

**Warning Statement 1005—Circuit Breaker**

This product relies on the building's installation for short-circuit (overcurrent) protection. To reduce risk of electric shock or fire, ensure that the protective device is rated not greater than:

AC: 20A

DC: 40A

---




---

**Warning Statement 1017—Restricted Area**

This unit is intended for installation in restricted access areas. Only skilled, instructed, or qualified personnel can access a restricted access area.

---




---

**Warning Statement 1018—Supply Circuit**

To reduce risk of electric shock and fire, take care when connecting units to the supply circuit so that wiring is not overloaded.

---




---

**Warning Statement 1022—Disconnect Device**

To reduce risk of electric shock and fire, a readily accessible two-poled disconnect device must be incorporated in the fixed wiring.

---




---

**Warning Statement 1025—Use Copper Conductors Only**

To reduce risk of fire, use copper conductors only.

---





---

**Warning** **Statement 1028**—More Than One Power Supply

This unit might have more than one power supply connection. To reduce risk of electric shock, remove all connections to de-energize the unit.



---

**Warning** **Statement 1029**—Blank Faceplates and Cover Panels

Blank faceplates and cover panels serve three important functions: they reduce the risk of electric shock and fire, they contain electromagnetic interference (EMI) that might disrupt other equipment, and they direct the flow of cooling air through the chassis. Do not operate the system unless all cards, faceplates, front covers, and rear covers are in place.



---

**Warning** **Statement 1030**—Equipment Installation

Only trained and qualified personnel should be allowed to install, replace, or service this equipment.



---

**Warning** **Statement 1073**—No User-Serviceable Parts

There are no serviceable parts inside. To avoid risk of electric shock, do not open.



---

**Warning** **Statement 1046**—Installing or Replacing the Unit

To reduce risk of electric shock, when installing or replacing the unit, the ground connection must always be made first and disconnected last.



---

**Warning** **Statement 1089**—Instructed and Skilled Person Definitions

An instructed person is someone who has been instructed and trained by a skilled person and takes the necessary precautions when working with equipment.

A skilled person or qualified personnel is someone who has training or experience in the equipment technology and understands potential hazards when working with equipment.

---



---

**Warning Statement 1090**—Installation by Skilled Person

Only a skilled person should be allowed to install, replace, or service this equipment. See statement 1089 for the definition of a skilled person.

---



---

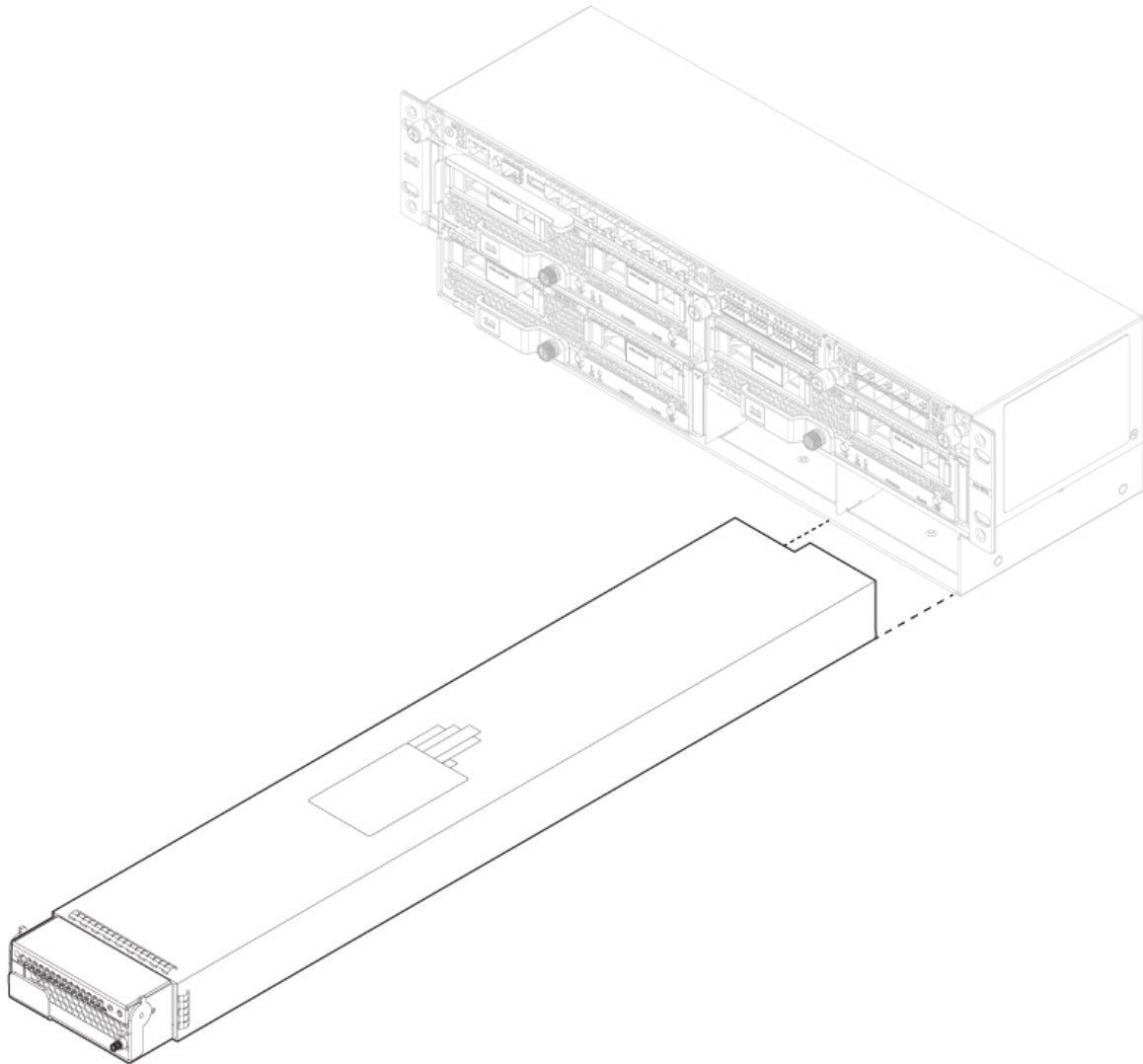
**Warning Statement 1091**—Installation by an Instructed Person

Only an instructed person or skilled person should be allowed to install, replace, or service this equipment. See statement 1089 for the definition of an instructed or skilled person.

---

- 
- Step 1** To remove the power supply module, face the front of the chassis, and loosen the captive screw on the right side of the power supply module.
- Step 2** Lift up the handle of the power supply to unseat it.
- Step 3** Using the handle, pull the power supply module from its slot. Place your other hand under the power supply module to support it while you slide it out of the chassis. Install the new power supply module immediately.

**Figure 47: Remove and Replace the Power Supply Module**



- Step 4** To install a new power supply, place the handle of the power supply module in the up position.
- Step 5** Hold the power supply module with both hands and slide it into the power supply module bay.
- Step 6** Gently push the power supply module into the chassis until it is fully seated, and press the handle down.
- Step 7** Tighten the captive screw on the right.
- Step 8** Verify the power supply module is operating correctly by checking the power supply module LED. See [Power Supply Modules](#), on page 26 for more information.
-

# Connect the DC Power Supply Module




---

**Note** Replace power supplies immediately. Power supply blanks are not available.

---

This procedure describes how to install and connect the DC power supply module to the rear PDU terminals on the chassis.

## Safety Warnings

Take note of the following power and component removal safety warnings:




---

**Warning** **Statement 347**—Failure to Secure the Expansion Module

To reduce the risk of electric shock, secure the modules with the provided screws.

---




---

**Warning** **Statement 1003**—DC Power Disconnection

Before performing any of the following procedures, ensure that power is removed from the DC circuit.

---




---

**Warning** **Statement 1005**—Circuit Breaker

This product relies on the building's installation for short-circuit (overcurrent) protection. To reduce risk of electric shock or fire, ensure that the protective device is rated not greater than:

AC: 20A

DC: 40A

---




---

**Warning** **Statement 1017**—Restricted Area

This unit is intended for installation in restricted access areas. Only skilled, instructed, or qualified personnel can access a restricted access area.

---




---

**Warning** **Statement 1018**—Supply Circuit

To reduce risk of electric shock and fire, take care when connecting units to the supply circuit so that wiring is not overloaded.

---

**Warning Statement 1022—Disconnect Device**

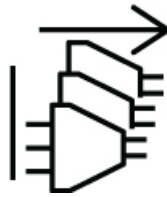
To reduce risk of electric shock and fire, a readily accessible two-poled disconnect device must be incorporated in the fixed wiring.

**Warning Statement 1025—Use Copper Conductors Only**

To reduce risk of fire, use copper conductors only.

**Warning Statement 1028—More Than One Power Supply**

This unit might have more than one power supply connection. To reduce risk of electric shock, remove all connections to de-energize the unit.

**Warning Statement 1029—Blank Faceplates and Cover Panels**

Blank faceplates and cover panels serve three important functions: they reduce the risk of electric shock and fire, they contain electromagnetic interference (EMI) that might disrupt other equipment, and they direct the flow of cooling air through the chassis. Do not operate the system unless all cards, faceplates, front covers, and rear covers are in place.

**Warning Statement 1030—Equipment Installation**

Only trained and qualified personnel should be allowed to install, replace, or service this equipment.

**Warning Statement 1073—No User-Serviceable Parts**

There are no serviceable parts inside. To avoid risk of electric shock, do not open.

**Warning Statement 1046—Installing or Replacing the Unit**

To reduce risk of electric shock, when installing or replacing the unit, the ground connection must always be made first and disconnected last.

**Warning Statement 1089**—Instructed and Skilled Person Definitions

An instructed person is someone who has been instructed and trained by a skilled person and takes the necessary precautions when working with equipment.

A skilled person or qualified personnel is someone who has training or experience in the equipment technology and understands potential hazards when working with equipment.

**Warning Statement 1090**—Installation by Skilled Person

Only a skilled person should be allowed to install, replace, or service this equipment. See statement 1089 for the definition of a skilled person.

**Warning Statement 1091**—Installation by an Instructed Person

Only an instructed person or skilled person should be allowed to install, replace, or service this equipment. See statement 1089 for the definition of an instructed or skilled person.

**Before you begin**

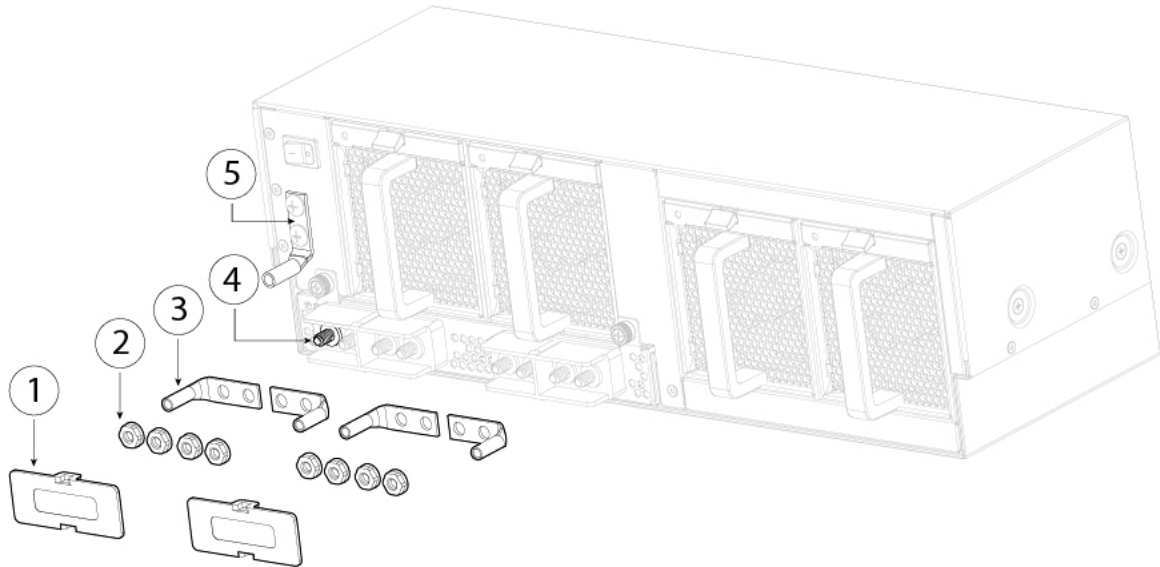
You need the following to connect the DC power supply module:

- Phillips head screwdriver
- 10-mm wrench or socket
- Connectors and wire for the DC circuit or circuits
- Two 2-hole lugs

These lugs are *not* provided in the accessory kit. We recommend lugs similar to the 90-degree DC Burndy YAZ6C2TC1490 lug. It accepts 1/4-20 threaded studs and has the correct stud spacing.

- 
- Step 1** Install the DC power supply module in the chassis and make note of the bay number so you can connect the wiring to the correct terminals on the DC power supply module at the rear of the chassis. See [Remove and Replace the Power Supply Module, on page 75](#) for the procedure.
- Step 2** Verify that the power is off to the DC circuit on the power supply module that you are installing.
- Step 3** Make sure that all site power and grounding requirements have been met.
- Step 4** Remove the plastic cover from the DC terminals by squeezing the flanges at the top and bottom of the cover.
- Step 5** Using the screws, connect the green ground wires to the chassis ground terminal. Only one ground connection is required even though there may be up to two DC connections.
- Step 6** Using the screws, connect the two 2-hole lugs to the power supply module terminal block.

Figure 48: Connect the DC Power Connectors and Ground Lugs



1	DC terminal covers	2	Nuts
3	Two 2-hole lugs (not provided in accessory kit)	4	DC terminals
5	Chassis ground lug		

**Step 7** Connect the DC-input wires to the power entry module terminal block. The proper wiring sequence is positive to positive (red wire) and negative to negative (black wire).

**Step 8** Replace the terminal covers as shown in the figure above.  
This cover should always be in place when power is applied to the terminals.

**Step 9** Set the DC disconnect switch in the circuit to ON.

**Caution** In a system with multiple power supplies, connect each power supply to a separate DC power source. In the event of a power source failure, if the second source is still available, it can maintain system operation.

**Step 10** Verify power supply operation by checking the power supply LED on the front of the chassis.

See [Power Supply Modules, on page 26](#) for the LED values.

## Connect the HVDC Power Supply Module



**Note** Replace power supplies immediately. Power supply blanks are not available.

This procedure describes how to install and connect the high-voltage (HV) DC power supply module to the rear power supply power feeds on the chassis. The load is shared when both power supply modules are plugged in and running at the same time. The HVDC power supply modules are hot swappable.

### Safety Warnings

Take note of the following power and component removal safety warnings:




---

**Warning** **Statement 347**—Failure to Secure the Expansion Module

To reduce the risk of electric shock, secure the modules with the provided screws.

---




---

**Warning** **Statement 1003**—DC Power Disconnection

Before performing any of the following procedures, ensure that power is removed from the DC circuit.

---




---

**Warning** **Statement 1005**—Circuit Breaker

This product relies on the building's installation for short-circuit (overcurrent) protection. To reduce risk of electric shock or fire, ensure that the protective device is rated not greater than:

AC: 20A

DC: 40A

---




---

**Warning** **Statement 1017**—Restricted Area

This unit is intended for installation in restricted access areas. Only skilled, instructed, or qualified personnel can access a restricted access area.

---




---

**Warning** **Statement 1018**—Supply Circuit

To reduce risk of electric shock and fire, take care when connecting units to the supply circuit so that wiring is not overloaded.

---




---

**Warning** **Statement 1022**—Disconnect Device

To reduce risk of electric shock and fire, a readily accessible two-poled disconnect device must be incorporated in the fixed wiring.

---





---

**Warning** **Statement 1025—Use Copper Conductors Only**

To reduce risk of fire, use copper conductors only.

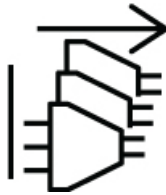
---



---

**Warning** **Statement 1028—More Than One Power Supply**

This unit might have more than one power supply connection. To reduce risk of electric shock, remove all connections to de-energize the unit.



---

**Warning** **Statement 1029—Blank Faceplates and Cover Panels**

Blank faceplates and cover panels serve three important functions: they reduce the risk of electric shock and fire, they contain electromagnetic interference (EMI) that might disrupt other equipment, and they direct the flow of cooling air through the chassis. Do not operate the system unless all cards, faceplates, front covers, and rear covers are in place.

---



---

**Warning** **Statement 1030—Equipment Installation**

Only trained and qualified personnel should be allowed to install, replace, or service this equipment.

---



---

**Warning** **Statement 1073—No User-Serviceable Parts**

There are no serviceable parts inside. To avoid risk of electric shock, do not open.

---



---

**Warning** **Statement 1046—Installing or Replacing the Unit**

To reduce risk of electric shock, when installing or replacing the unit, the ground connection must always be made first and disconnected last.

---



**Warning Statement 1089**—Instructed and Skilled Person Definitions

An instructed person is someone who has been instructed and trained by a skilled person and takes the necessary precautions when working with equipment.

A skilled person or qualified personnel is someone who has training or experience in the equipment technology and understands potential hazards when working with equipment.

---



**Warning Statement 1090**—Installation by Skilled Person

Only a skilled person should be allowed to install, replace, or service this equipment. See statement 1089 for the definition of a skilled person.

---



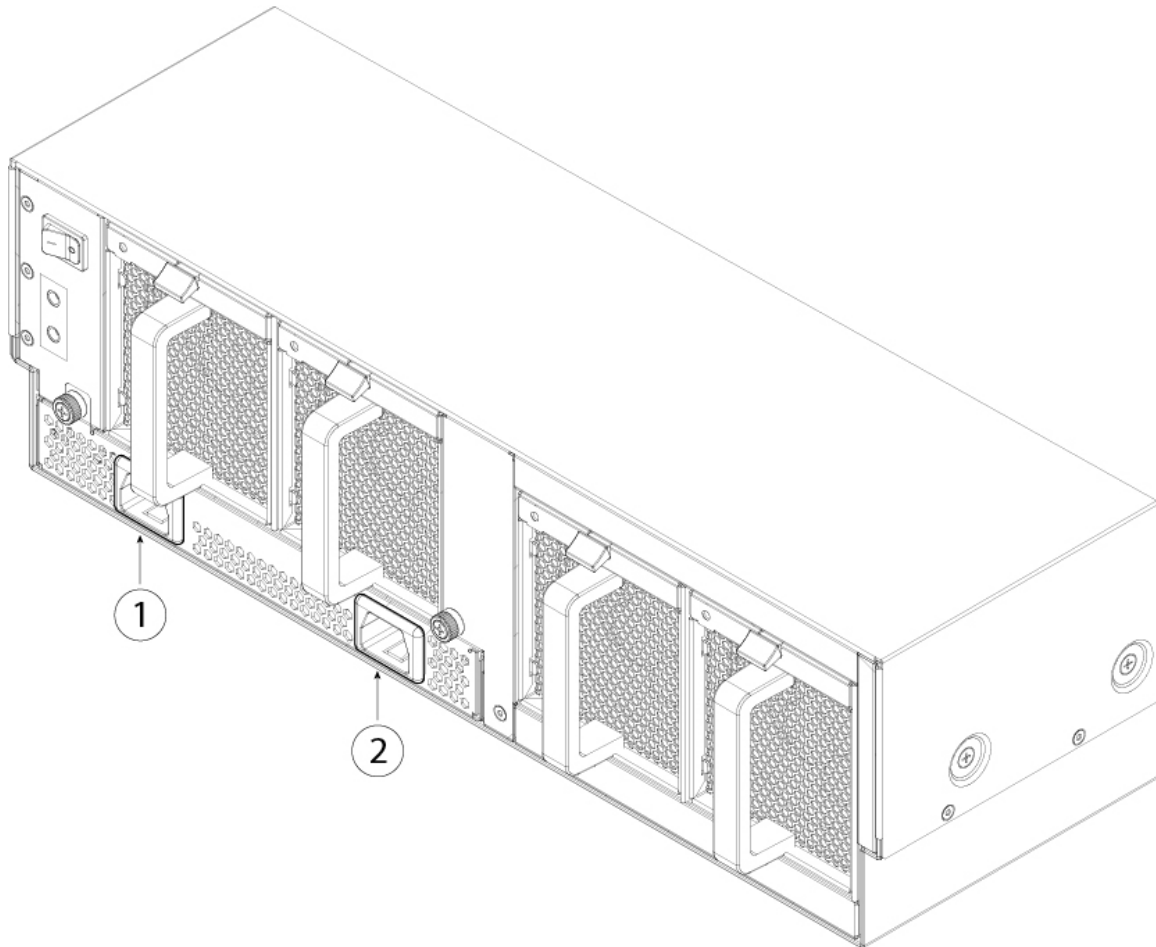
**Warning Statement 1091**—Installation by an Instructed Person

Only an instructed person or skilled person should be allowed to install, replace, or service this equipment. See statement 1089 for the definition of an instructed or skilled person.

---

- 
- Step 1** Install the HVDC power supply module in the chassis and make note of the bay number so you can connect the HVDC power cord to the correct power feed on the HVDC power supply module at the rear of the chassis. See [Remove and Replace the Power Supply Module, on page 75](#) for the procedure.
- Step 2** Verify that the power is off to the DC circuit on the power supply module that you are installing.
- Step 3** Make sure that all site power and grounding requirements have been met.
- Step 4** Plug the HVDC power cord into the power feeds for PSU-1 and/or PSU-2.

Figure 49: HVDC Power Feeds



1	Power feed for PSU-2	2	Power feed for PSU-1
---	----------------------	---	----------------------

**Step 5** Set the HVDC disconnect switch in the circuit to ON.

**Caution** In a system with multiple power supplies, connect each power supply to a separate HVDC power source. In the event of a power source failure, if the second source is still available, it can maintain system operation.

**Step 6** Verify power supply operation by checking the power supply LED on the front of the chassis.

See [Power Supply Modules, on page 26](#) for the LED values.

## Remove and Replace the Fan Module

You can remove and replace fan modules while the system is running. The airflow moves from front to back. See [Fan Modules, on page 28](#) for more information about the fan module.




---

**Note** The chassis is designed to have all fan modules in place and operating at all times. Do not leave the fan module bay empty for longer than is necessary to replace it with a new fan module.

---

### Safety Warnings

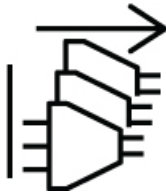
Take note of the following component replacement safety warnings




---

**Warning Statement 1028—More Than One Power Supply**

This unit might have more than one power supply connection. To reduce risk of electric shock, remove all connections to de-energize the unit.




---

**Warning Statement 1030—Equipment Installation**

Only trained and qualified personnel should be allowed to install, replace, or service this equipment.

---




---

**Warning Statement 1073—No User-Serviceable Parts**

There are no serviceable parts inside. To avoid risk of electric shock, do not open.

---




---

**Warning Statement 1089—Instructed and Skilled Person Definitions**

An instructed person is someone who has been instructed and trained by a skilled person and takes the necessary precautions when working with equipment.

A skilled person or qualified personnel is someone who has training or experience in the equipment technology and understands potential hazards when working with equipment.

---




---

**Warning Statement 1090—Installation by Skilled Person**

Only a skilled person should be allowed to install, replace, or service this equipment. See statement 1089 for the definition of a skilled person.

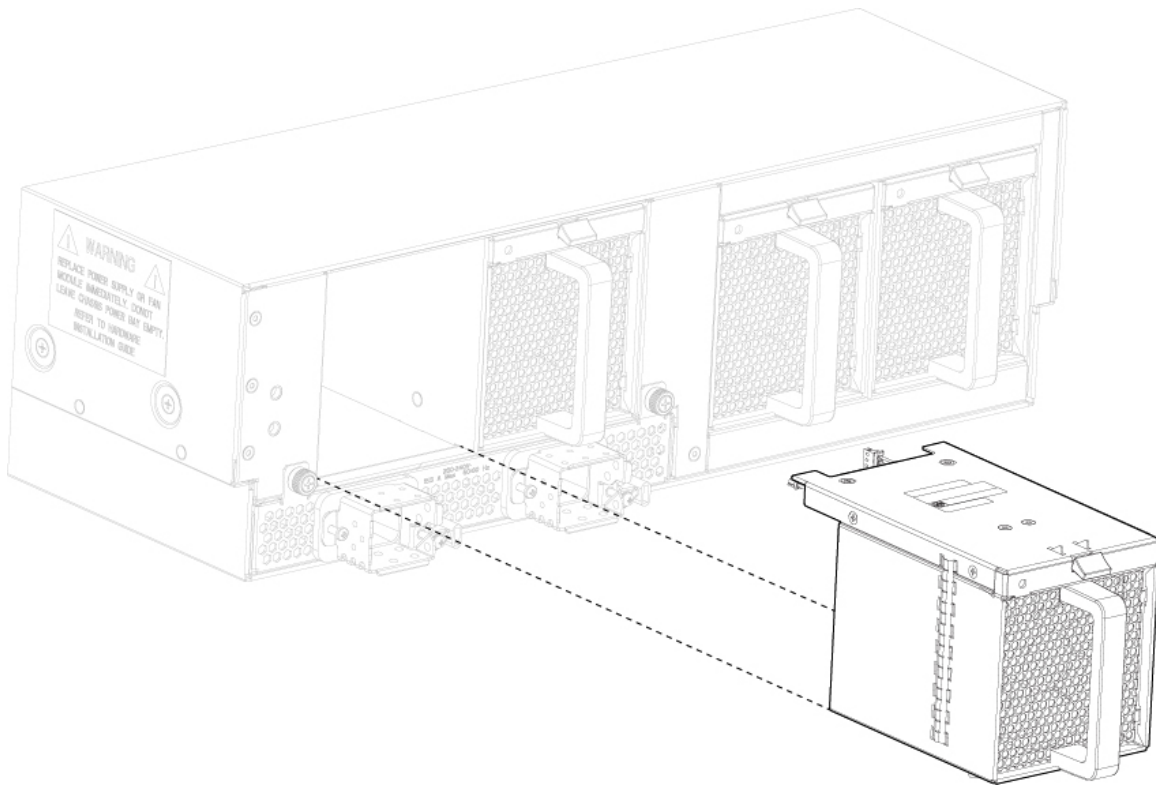
---

**Warning Statement 1091**—Installation by an Instructed Person

Only an instructed person or skilled person should be allowed to install, replace, or service this equipment. See statement 1089 for the definition of an instructed or skilled person.

- Step 1** To remove a fan module, face the rear of the chassis, and hold the handle of the fan module.
- Step 2** Press down on the spring latch at the top of the fan module.
- Step 3** Pull the fan module out of the chassis.

*Figure 50: Remove and Replace the Fan Module*



- Step 4** To install a new fan module, hold the fan module with the spring latch at the top of the module.
- Step 5** Push the fan module into the chassis until it is properly seated and the spring latch snaps into place. If the system is powered on, listen for the fans. You should immediately hear the fans operating. If you do not hear the fans, make sure the fan module is inserted completely into the chassis and the faceplate is flush with the outside surface of the chassis.
- Step 6** Verify that the fan is operational by checking the fan module LED. It takes about a minute for the Fan LED to be updated. See [Fan Modules](#), on page 28 for a description of the fan module LEDs.

# Install the FIPS Opacity Shield



**Caution** This procedure should be performed only by the Crypto Officer. If your Firepower 9300 is already up and running when you receive the FIPS opacity shield, the Crypto Officer must power it down, remove cables, attach the FIPS opacity shield, attach the tamper-evident labels (TEL), recable, and power on the Firepower 9300. See the [FIPS 140-2 Non Proprietary Security Policy Level 2 Validation](#) document for more information about the duties of the Crypto Officer.

This procedure describes how to install the FIPS opacity shield on the front of a Firepower 9300 that is already rack-mounted. The FIPS opacity shield has an access cover that is already attached with two captive screws. The FIPS opacity shield covers the pullout asset card on the front panel that contains the serial number, but there is another pullout asset card on the side of the chassis and the serial number is also printed on the top of the Supervisor. See [Serial Number Location, on page 8](#) for the placements of the serial number on the chassis. You need the serial number whenever you contact Cisco TAC.

## Before you begin

You need the following before you install the FIPS opacity shield:

- Phillips head screwdriver
- Chassis already rack-mounted
- All cabling disconnected from the front of the chassis
- FIPS kit
  - Four 10-32 x .75 -inch screws
  - FIPS opacity shield
  - Twelve tamper-evident labels

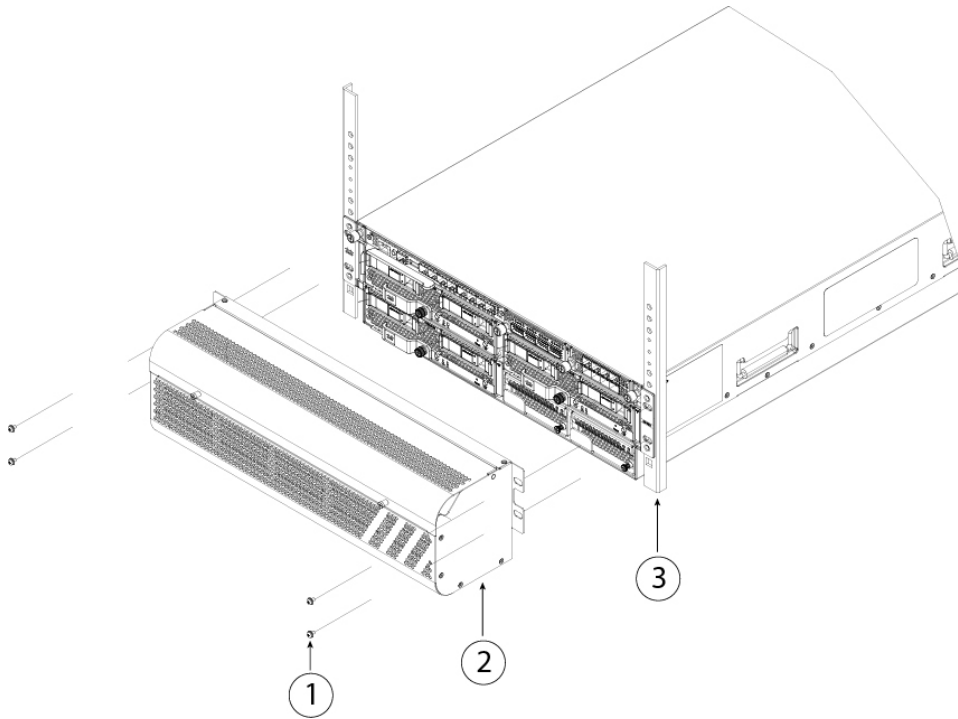
---

**Step 1** Remove the two screws from each side of the chassis brackets.

The chassis sits on rails that support its weight so it will not fall when the screws are removed.

**Step 2** Using the four 10-32 x .75-in. screws from the FIPS kit, attach the FIPS opacity shield to the left and right chassis brackets, two for each side.

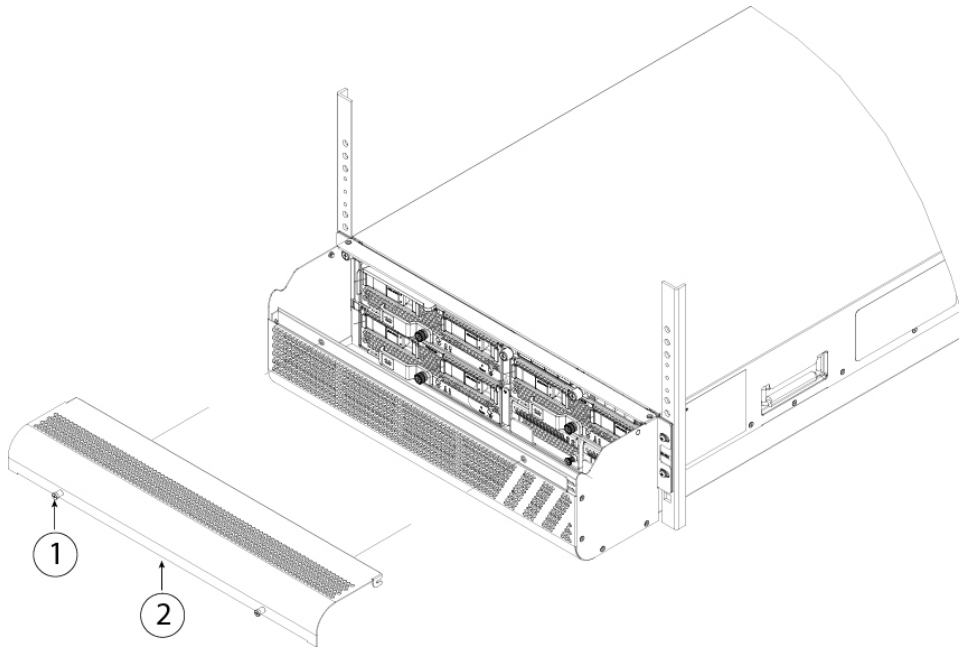
Figure 51: Install the FIPS Opacity Shield to the Rack-Mount Rails



1	Screws	2	FIPS opacity shield
3	Rack-mount rails		

**Step 3** Unscrew the two captive screws on the front of the access cover to remove the access cover so that you can connect the cables to the ports.

Figure 52: Remove the FIPS Access Cover



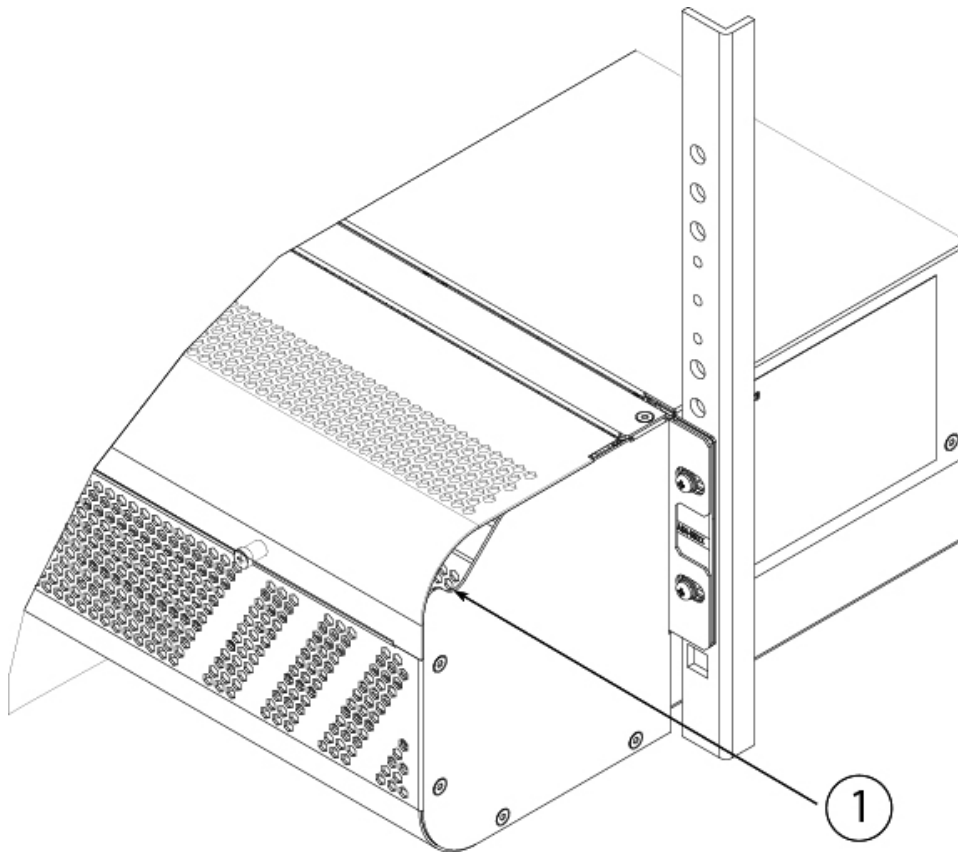
1	Captive screws	2	Access cover
---	----------------	---	--------------

**Step 4** Connect the cables to the ports. See the getting started guides listed in Step 9 for the procedure.

**Step 5** Run the cables through the openings on either side of the FIPS opacity shield and reattach the FIPS access cover by tightening the captive screws.



**Figure 53: Run the Cables Through the FIPS Opacity Shield**



<b>1</b>	Cable exit		
----------	------------	--	--

- Step 6** Attach the TELs. For information on the procedure and correct placement of the TELs, see the Tamper Evidence Label (TEL) Placement section in the [FIPS 140-2 Non Proprietary Security Policy Level 2 Validation](#) document.
- Step 7** Connect the power cords to the chassis, and plug the other end into your power source. The chassis has a power switch on the rear. Toggle it to the ON position.
- Note** The initial AC-power chassis does not have an on/off switch; it powers on when you plug it into a power source.
- Note** When you toggle the power switch from ON to OFF, it takes several seconds for the system to power down. Do not remove the power cable until the power LED is off. After removing power from the chassis either by moving the power switch to OFF or unplugging the power cord, wait at least 10 seconds before turning power back ON.
- Step 8** Check the SYS LED on the front of the chassis. See [Supervisor, on page 11](#) for a description of the SYS LED. When the SYS LED is solid green, the chassis has booted up successfully.
- Step 9** See the [Cisco Firepower 9300 Getting Started Guide](#) for further configuration information.

