



Cisco Firepower Management Center 1600, 2600, and 4600 Hardware Installation Guide

First Published: 2019-06-26

Last Modified: 2022-04-29

Americas Headquarters

Cisco Systems, Inc.
170 West Tasman Drive
San Jose, CA 95134-1706
USA
<http://www.cisco.com>
Tel: 408 526-4000
800 553-NETS (6387)
Fax: 408 527-0883

THE SPECIFICATIONS AND INFORMATION REGARDING THE PRODUCTS IN THIS MANUAL ARE SUBJECT TO CHANGE WITHOUT NOTICE. ALL STATEMENTS, INFORMATION, AND RECOMMENDATIONS IN THIS MANUAL ARE BELIEVED TO BE ACCURATE BUT ARE PRESENTED WITHOUT WARRANTY OF ANY KIND, EXPRESS OR IMPLIED. USERS MUST TAKE FULL RESPONSIBILITY FOR THEIR APPLICATION OF ANY PRODUCTS.

THE SOFTWARE LICENSE AND LIMITED WARRANTY FOR THE ACCOMPANYING PRODUCT ARE SET FORTH IN THE INFORMATION PACKET THAT SHIPPED WITH THE PRODUCT AND ARE INCORPORATED HEREIN BY THIS REFERENCE. IF YOU ARE UNABLE TO LOCATE THE SOFTWARE LICENSE OR LIMITED WARRANTY, CONTACT YOUR CISCO REPRESENTATIVE FOR A COPY.

The Cisco implementation of TCP header compression is an adaptation of a program developed by the University of California, Berkeley (UCB) as part of UCB's public domain version of the UNIX operating system. All rights reserved. Copyright © 1981, Regents of the University of California.

NOTWITHSTANDING ANY OTHER WARRANTY HEREIN, ALL DOCUMENT FILES AND SOFTWARE OF THESE SUPPLIERS ARE PROVIDED "AS IS" WITH ALL FAULTS. CISCO AND THE ABOVE-NAMED SUPPLIERS DISCLAIM ALL WARRANTIES, EXPRESSED OR IMPLIED, INCLUDING, WITHOUT LIMITATION, THOSE OF MERCHANTABILITY, FITNESS FOR A PARTICULAR PURPOSE AND NON-INFRINGEMENT OR ARISING FROM A COURSE OF DEALING, USAGE, OR TRADE PRACTICE.

IN NO EVENT SHALL CISCO OR ITS SUPPLIERS BE LIABLE FOR ANY INDIRECT, SPECIAL, CONSEQUENTIAL, OR INCIDENTAL DAMAGES, INCLUDING, WITHOUT LIMITATION, LOST PROFITS OR LOSS OR DAMAGE TO DATA ARISING OUT OF THE USE OR INABILITY TO USE THIS MANUAL, EVEN IF CISCO OR ITS SUPPLIERS HAVE BEEN ADVISED OF THE POSSIBILITY OF SUCH DAMAGES.

Any Internet Protocol (IP) addresses and phone numbers used in this document are not intended to be actual addresses and phone numbers. Any examples, command display output, network topology diagrams, and other figures included in the document are shown for illustrative purposes only. Any use of actual IP addresses or phone numbers in illustrative content is unintentional and coincidental.

All printed copies and duplicate soft copies of this document are considered uncontrolled. See the current online version for the latest version.

Cisco has more than 200 offices worldwide. Addresses and phone numbers are listed on the Cisco website at www.cisco.com/go/offices.

The documentation set for this product strives to use bias-free language. For purposes of this documentation set, bias-free is defined as language that does not imply discrimination based on age, disability, gender, racial identity, ethnic identity, sexual orientation, socioeconomic status, and intersectionality. Exceptions may be present in the documentation due to language that is hardcoded in the user interfaces of the product software, language used based on standards documentation, or language that is used by a referenced third-party product.

Cisco and the Cisco logo are trademarks or registered trademarks of Cisco and/or its affiliates in the U.S. and other countries. To view a list of Cisco trademarks, go to this URL: <https://www.cisco.com/c/en/us/about/legal/trademarks.html>. Third-party trademarks mentioned are the property of their respective owners. The use of the word partner does not imply a partnership relationship between Cisco and any other company. (1721R)

© 2019-2022 Cisco Systems, Inc. All rights reserved.



CONTENTS

CHAPTER 1

Overview 1

- Features 1
- Package Contents 4
- Serial Number Locations 4
- Front Panel 6
- Front Panel LEDs 9
- Rear Panel 12
- Rear Panel LEDs 13
- Power Supply 14
- Hardware Specifications 15
- Product ID Numbers 15
- Power Cord Specifications 16

CHAPTER 2

Installation Preparation 25

- Installation Warnings 25
- Safety Recommendations 28
- Maintain Safety with Electricity 28
- Prevent ESD Damage 29
- Site Environment 29
- Power Supply Considerations 29
- Rack Configuration Considerations 29

CHAPTER 3

Rack-Mount the Chassis 31

- Unpack and Inspect the Chassis 31
- Rack-Mount the Chassis 31

CHAPTER 4	Installation, Maintenance, and Upgrade	35
	Power Button Shutdown	35
	Remove and Replace a Drive	36
	Remove and Replace a Power Supply	39



CHAPTER 1

Overview

- [Features, on page 1](#)
- [Package Contents, on page 4](#)
- [Serial Number Locations, on page 4](#)
- [Front Panel, on page 6](#)
- [Front Panel LEDs, on page 9](#)
- [Rear Panel, on page 12](#)
- [Rear Panel LEDs, on page 13](#)
- [Power Supply, on page 14](#)
- [Hardware Specifications, on page 15](#)
- [Product ID Numbers, on page 15](#)
- [Power Cord Specifications, on page 16](#)

Features

The Cisco Firepower Management Center (FMC) 1600, 2600, and 4600 management appliances run software that provides extensive intelligence about the users, applications, devices, threats, and vulnerabilities that exist in your network. It also uses this information to analyze your network's vulnerabilities. It then provides tailored recommendations on what security policies to put in place and what security events you should investigate.

See [Product ID Numbers, on page 15](#) for a list of the field-replaceable product IDs (PIDs) associated with the FMC 1600, 2600, and 4600. You can remove and replace drives and power supplies. For all other internal component failures, you must send your chassis for return material authorization (RMA).

The FMC management appliances support Cisco Firepower Threat Defense software. See the [Cisco Firepower Compatibility Guide](#), which provides Cisco Firepower software and hardware compatibility, including operating system and hosting environment requirements, for each supported Firepower version.

The following table lists the features of the FMC 1600, 2600, and 4600.

Table 1: FMC 1600, 2600, and 4600 Features

Feature	1600	2600	4600
Security standards certifications	<ul style="list-style-type: none"> • Common Criteria Certification for the Network Device Collaborative Protection Profile (NDcPPv2.2E), Firewall Collaborative Protection Profile Module (MOD_FW_v1.4e), Virtual Private Network Gateway Protection Profile Module (MOD_VPNGW_v1.1), and IPS Extended Package (IPSEP v2.11) on FTD 6.4.x and FX-OS 2.6.x • Federal Information Processing Standards (FIPS) 140-2 on FTD 6.4.x • Department of Defense Information Network Approved Product List (DoDIN APL) • US Government Compliance for IPv6 (USGv6) and Ready Logo certified on FMC 7.0.x <p>See the "Security Certifications Compliance" topic in the "Appliance Platform Settings" chapter in the Firepower Management Center Configuration Guide, Version 6.7 for the instructions on how to enable security certifications compliance.</p>		
Form factor	1 RU		
Rack mount	Standard 19-in. (48.3 cm) 4-post EIA rack		
Airflow	Front to rear Cold aisle to hot aisle		
Pullout asset card	Displays the serial number and the MAC address for the two built-in management ports		
Grounding hole	Two threaded holes for a dual-hole grounding lug Use is optional; the supported AC power supplies have internal grounding, so no additional chassis grounding is required.		
Unit identification button	On the front panel		
Power button	On the rear panel		
Processor	Before January 2021: One Intel Xeon 4110 processor After January 2021: One Intel Xeon 4215	Before January 2021: Two Intel Xeon 4110 processors After January 2021: Two Intel Xeon 4215	Before January 2021: Two Intel Xeon 4116 processors After January 2021: Two Intel Xeon 4214
Memory	32-GB RAM	64-GB RAM	128-GB RAM

Feature	1600	2600	4600
RDIMMs Internal component only; not field-replaceable	Before January 2021: Two 16-GB DDR4-2400-MHz DIMMs After January 2021: Two 16-GB DDR4-2933-MHz DIMMs	Before January 2021: Four 16-GB DDR4-2400-MHz DIMMs After January 2021: Four 16-GB DDR4-2933-MHz DIMMs	Before January 2021: Eight 16-GB DDR4-2400-MHz DIMMs After January 2021: Eight 16-GB DDR4-2933-MHz DIMMs
Management ports	Two built-in RJ-45 SFP+ ports Support for 1000 Mbps, 1 Gbps, and 10 Gbps The primary management port is eth0. You can use eth1, eth2, and eth3 as secondary management or event ports.		
USB ports	Two USB 3.0 Type A		
VGA port	One 3-row 15-pin DB-15 connector Enabled by default		
SFP ports	Two fixed SFP+ ports		
Supported SFP+	SFP-10G-SR (10 Gb) SFP-10G-LR (10 Gb) Note Only these two SFPs have been qualified for use on the FMC. Although non-Cisco SFPs and other Cisco SFPs are allowed, we do not recommend using them because they have not been tested and validated by Cisco. Cisco TAC may refuse support for any interoperability problems that result from using an untested SFP transceiver.		
Serial console port	RJ-45 serial port running RS-232 (RS-232D TIA-561)		
System power	Two 770-W AC power supplies Hot-swappable and redundant as 1+1		
Power consumption	2626 BTU/hr		
Fans	Six fans for front-to-rear cooling Internal component only; not field-replaceable		
Storage	Two 1.2-TB 10-K SAS HDDs RAID 1, hot-swappable	Four 600-GB 10-K SAS HDDs RAID 5, hot-swappable	Ten 1.2-TB SAS HDDs RAID 6, hot-swappable

Package Contents

The following figure shows the package contents for the FMC 1600, 2600, and 4600. Note that the contents are subject to change and your exact contents might contain additional or fewer items.

Figure 1: Package Contents

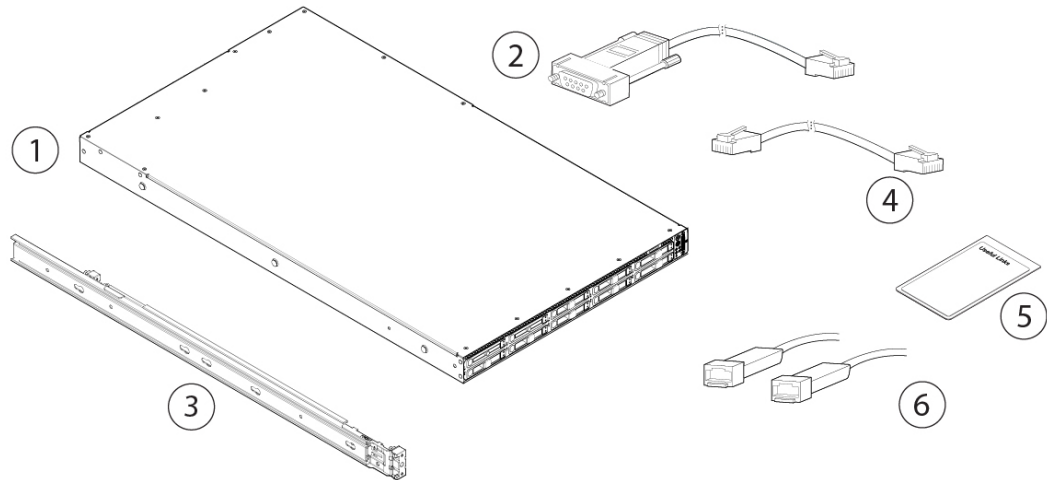

1	Chassis	2	RJ-45 to DP9-RS232 console cable (Cisco part number 72-3383-XX)	
3	Cisco rail kit (Cisco part number 800-43376-02)	4	RJ-45 to RJ-45 Cat 5 Ethernet cable, yellow six feet long (Cisco part number 72-1482-XX)	
5	<p><i>Useful Links Cisco Firepower Management Center 1600, 2600, and 4600</i></p> <p>The steps in the Useful Links document send you to the documentation you need to install, set up, and configure your FMC.</p>		6	Two 10-Gb SFP+ transceivers with cables Optional for all models; in package if ordered.

Serial Number Locations

The serial number (SN) for the FMC 1600, 2600, and 4600 is printed on the pullout asset card located on the front panel as shown in the following figure of the FMC 1600.

Figure 2: Serial Number on Pullout Asset Card

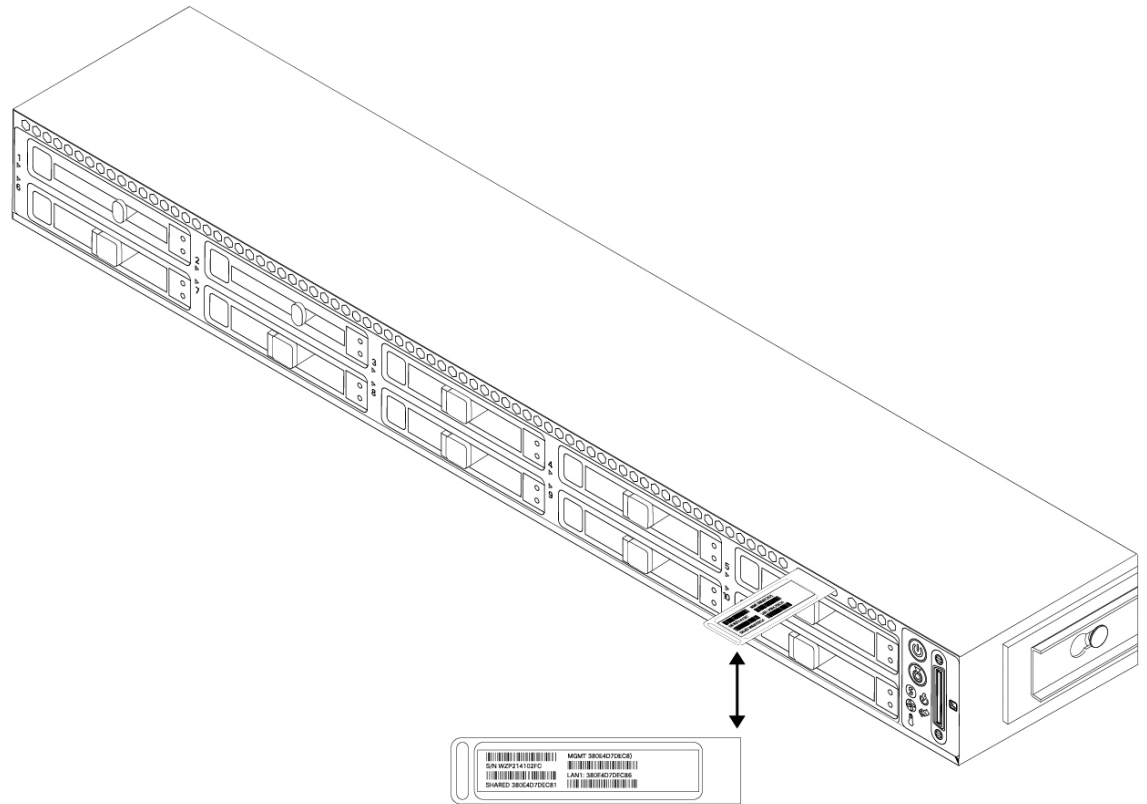

The serial number is also on the label on the cover of the chassis as shown in the following figure.



Caution

The cover latch on the top of the chassis cover is not supported. There are no internal field-replaceable parts in the FMC 1600, 2600, and 4600.

Figure 3: Serial Number Location on Cover

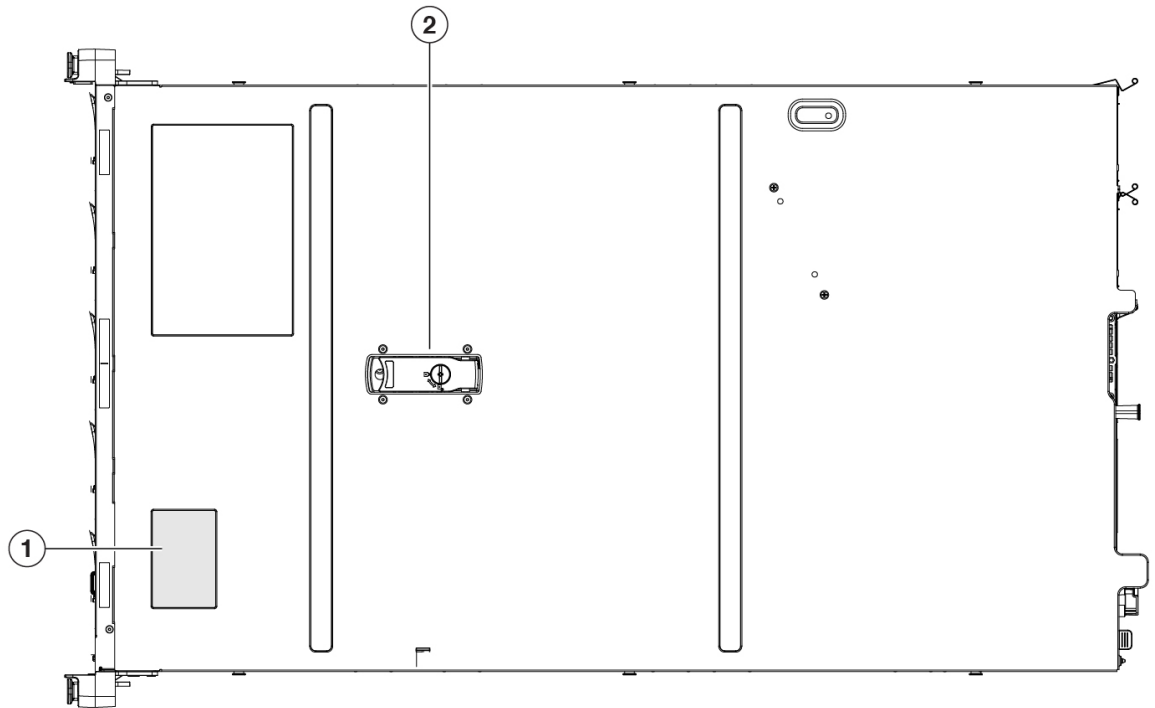

1	Serial number label	2	Cover latch Not supported
---	---------------------	---	------------------------------

Front Panel

The following figure shows the front panel features and disk-drive configuration for the FMC 1600. See [Front Panel LEDs, on page 9](#) for a description of the LEDs.

Figure 4: FMC 1600 Front Panel

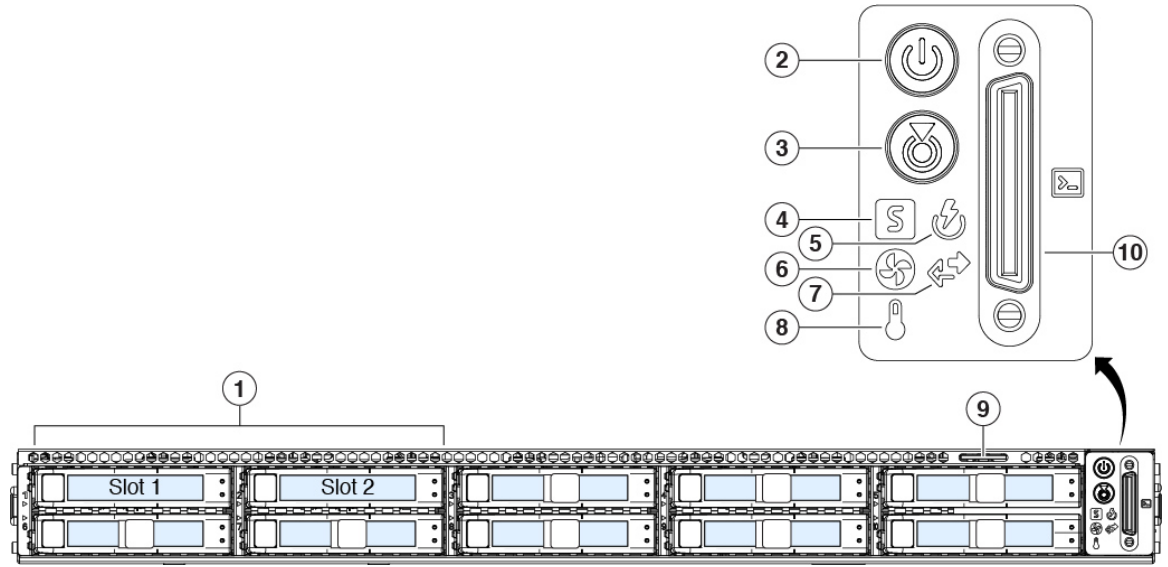

1	Drive bays Supports two SAS HDDs in slots 1 and 2	2	Power button/power status LED
3	Unit identification button/LED	4	System status LED
5	Power supply status LED	6	Fan status LED
7	Network link activity LED	8	Temperature status LED
9	Pullout asset card	10	Keyboard, video, and mouse (KVM) port Not supported; use the VGA and USB keyboard ports instead.

The following figure shows the front panel features and disk-drive configuration for the FMC 2600. See [Front Panel LEDs, on page 9](#) for a description of the LEDs.

Figure 5: FMC 2600 Front Panel

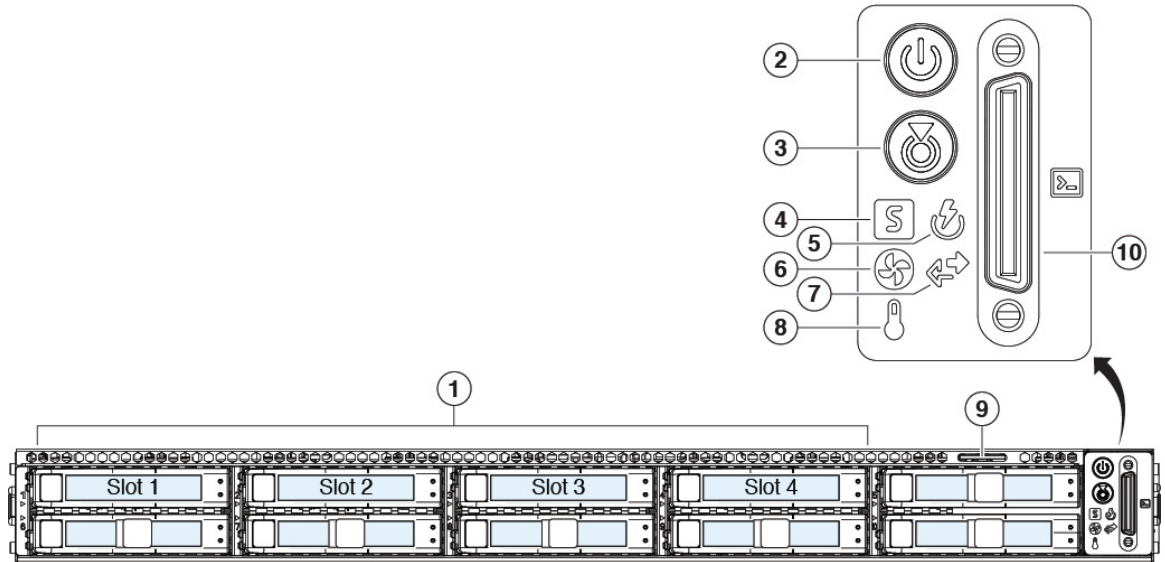

1 Drive bays Supports four SAS HDDs in slots 1 through 4	2 Power button/power status LED
3 Unit identification button/LED	4 System status LED
5 Power supply status LED	6 Fan status LED
7 Network link activity LED	8 Temperature status LED
9 Pullout asset card	10 KVM port Not supported; use the VGA and USB keyboard ports instead.

The following figure shows the front panel features and disk-drive configuration for the FMC 4600. See [Front Panel LEDs, on page 9](#) for a description of the LEDs.

Figure 6: FMC 4600 Front Panel

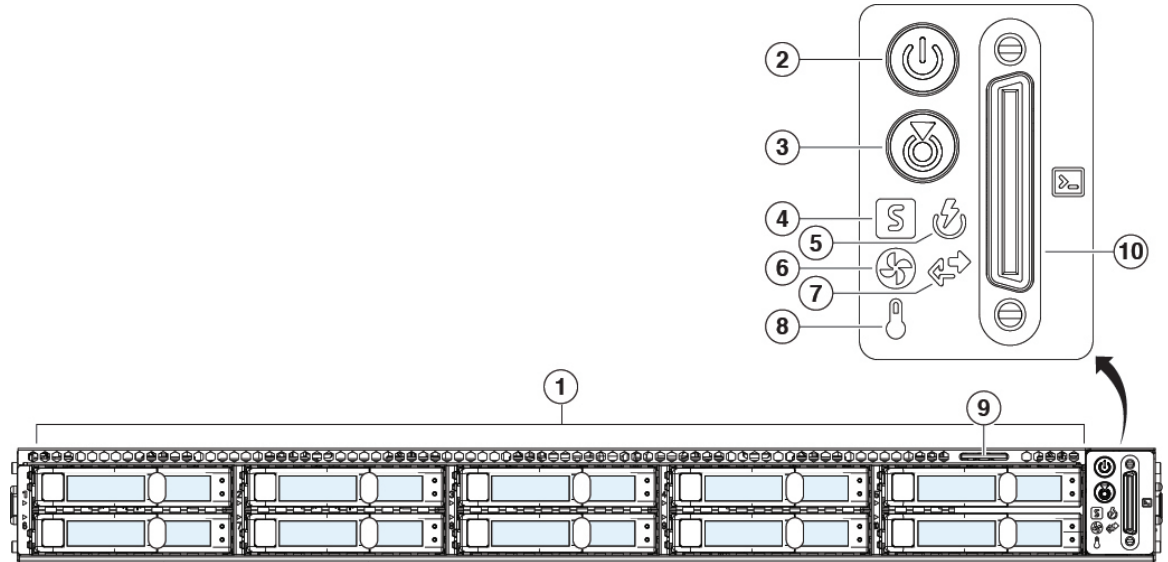

1	Drive bays Supports ten SAS HDDs in slots 1 through 6	2	Power button/power status LED
3	Unit identification button/LED	4	System status LED
5	Power supply status LED	6	Fan status LED
7	Network link activity LED	8	Temperature status LED
9	Pullout asset card	10	KVM port Not supported; use the VGA and USB keyboard ports instead.

Front Panel LEDs

The following figure shows the front panel LEDs and describes their states.

Figure 7: Front Panel LEDs and Their States

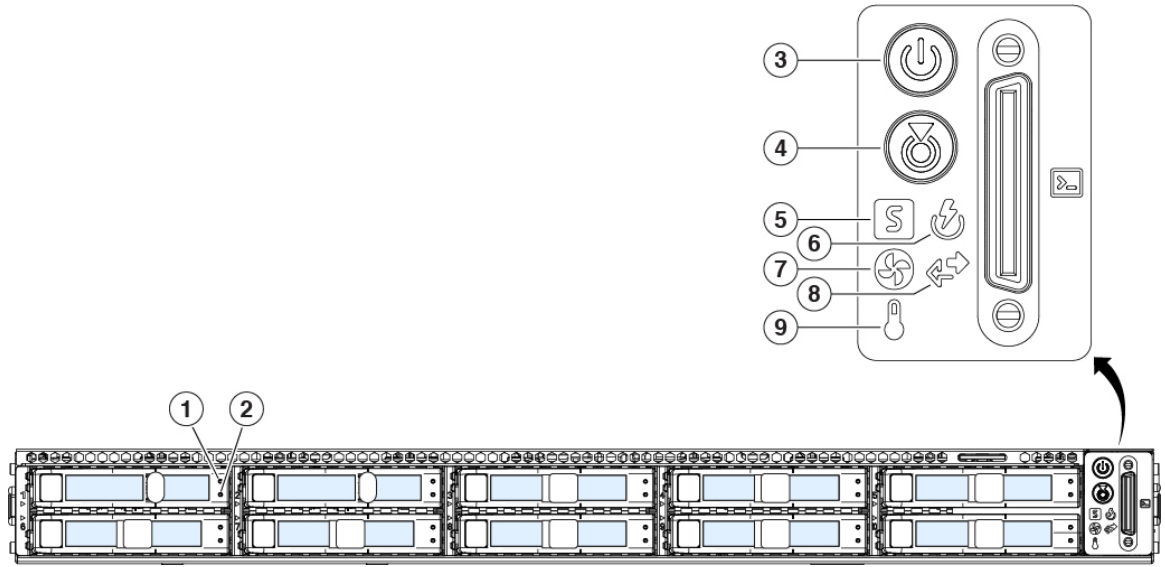

<p>1 Drive fault LED:</p> <ul style="list-style-type: none"> • Off—The drive is operating properly. • Amber—Drive fault detected. • Amber, flashing—The drive is rebuilding. • Amber, flashing with 1-second interval—Drive locate function activated in the software. 	<p>2 Drive activity LED:</p> <ul style="list-style-type: none"> • Off—There is no drive in the drive tray (no access, no fault). • Green—The drive is ready. • Green, flashing—The drive is reading or writing data.
<p>3 Power LED:</p> <ul style="list-style-type: none"> • Off—There is no AC power to the chassis. • Amber—The chassis is in standby mode. • Green—The chassis is in main power mode. Power is supplied to all components. 	<p>4 Unit identification LED:</p> <ul style="list-style-type: none"> • Off—The unit identification function is not in use. • Blue, flashing—The unit identification function is activated.

5	<p>System status LED:</p> <ul style="list-style-type: none"> • Green—The chassis is running in normal operating condition. • Green, flashing—The chassis is performing system initialization and memory check. • Amber—The chassis is in a degraded operational state (minor fault). <ul style="list-style-type: none"> • Power supply redundancy is lost. • CPUs are mismatched. • At least one CPU is faulty. • At least one DIMM is faulty. • At least one drive in a RAID configuration failed. • Amber, two flashes—There is a major fault with the system board. • Amber, three flashes—There is a major fault with the DIMMs. • Amber, four flashes—There is a major fault with the CPUs. 	6	<p>Power supply status LED:</p> <ul style="list-style-type: none"> • Green—All power supplies are operating normally. • Amber—One or more power supplies are in a degraded operational state. • Amber, flashing—One or more power supplies are in a critical fault state.
7	<p>Fan status LED:</p> <ul style="list-style-type: none"> • Green—All fans are operating properly. • Amber, flashing—One or more fans breached the unrecoverable threshold. 	8	<p>Network link activity LED:</p> <ul style="list-style-type: none"> • Off—The Ethernet port link is idle. • Green—One or more Ethernet ports are link-active, but there is no activity. • Green, flashing—One or more Ethernet ports are link-active with activity.
9	<p>Temperature status LED:</p> <ul style="list-style-type: none"> • Green—The chassis is operating at normal temperature. • Amber—One or more temperature sensors breached the critical threshold. • Amber, flashing—One or more temperature sensors breached the unrecoverable threshold. 		

Rear Panel



Note The Cisco Integrated Management Controller (CIMC) is only supported for Lights-Out Management (LOM) access on the CIMC port (labeled M) on a Serial Over LAN (SOL) connection to remotely monitor or manage the FMC system. For information on using LOM and SOL, see the "Set Up Lights Out Management" section in the [Cisco Firepower Management Center Getting Started Guide for Models 1600, 2600, and 4600](#).

The following figure shows the rear panel of the FMC 1600, 2600, and 4600.

Figure 8: Rear Panel

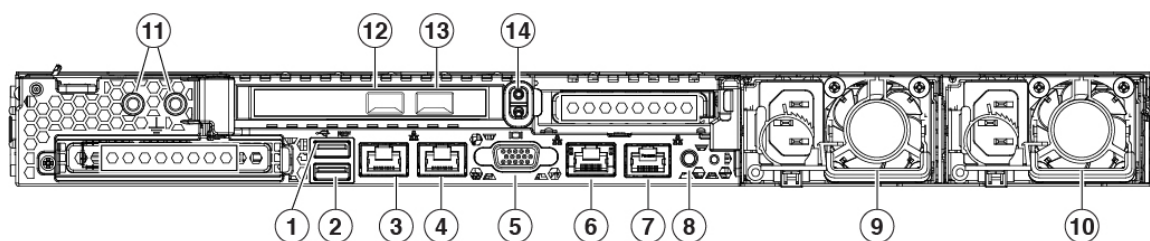

1	USB 3.0 Type A (USB 1) You can connect a keyboard, and along with a monitor on the VGA port, you can access the console.	2	USB 3.0 Type A (USB 2) You can connect a keyboard, and along with a monitor on the VGA port, you can access the console.
3	eth0 management interface (labeled 1) Supports 100/1000/10000 Mbps depending on link partner capability.	4	eth1 management interface (labeled 2) Gigabit Ethernet 100/1000/10000 Mbps interface, RJ-45, LAN2
5	VGA video port (DB-15 connector)	6	CIMC interface (labeled M) Note CIMC is supported <i>only</i> for LOM access. CIMC is <i>not</i> supported on any other interfaces.
7	Serial console port (RJ-45 connector) Disabled by default; use the VGA port and keyboard USB port instead. For more information on the serial port, see the "Set up Serial Access" topic in the Cisco Firepower Management Center Getting Started Guide for Models 1600, 2600, and 4600 .	8	Unit identification button
9	770-W AC power supply (PSU 1)	10	770-W AC power supply (PSU 2)

11	Threaded holes for dual-hole grounding lug	12	eth2 management interface (Optional) 10-Gigabit Ethernet SFP+ support SFP-10G-SR and SFP-10G-LR are qualified for use on the FMC.
13	eth3 management interface (Optional) 10-Gigabit Ethernet SFP+ support SFP-10G-SR and SFP-10G-LR are qualified for use on the FMC.	14	Riser handle Not supported

Rear Panel LEDs

The following figure shows the rear panel LEDs and describes their states.

Figure 9: Rear Panel LEDs and Their States

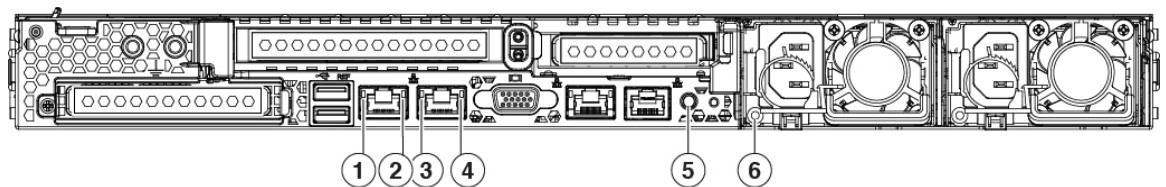

1	100-Mbps/1-Gbps/10-Gbps Ethernet link (speed on both LAN1 and LAN2): <ul style="list-style-type: none"> • Off—Link speed is 100 Mbps. • Amber—Link speed is 1 Gbps. • Green—Link speed is 10 Gbps. 	2	100-Mbps/1-Gbps/10-Gbps Ethernet link status (speed on both LAN1 and LAN2): <ul style="list-style-type: none"> • Off—No link is present. • Green—Link is active. • Green, flashing—Traffic is present on the active link.
3	1-Gbps Ethernet dedicated management link: <ul style="list-style-type: none"> • Off—Link speed is 10 Mbps. • Amber—Link speed is 100 Gbps. • Green—Link speed is 1 Gbps. 	4	1-Gbps Ethernet dedicated management link: <ul style="list-style-type: none"> • Off—No link is present. • Amber—Link is active. • Green, flashing—Traffic is present on the active link.

5	<p>Unit identification:</p> <ul style="list-style-type: none"> • Off—The unit identification function is not in use. • Blue, flashing—The unit identification function is activated. 	6	<p>Power supply (one LED for each power supply):</p> <ul style="list-style-type: none"> • Off—No AC input (12-V main power off; 12-V standby power off) • Green, flashing—12-V main power off; 12-V standby power on. • Green—12-V main power on; 12-V standby power on. • Amber, flashing—Warning threshold detected but 12-V main power on. • Amber—Critical error detected; 12-V main power off (for example, overcurrent, overvoltage, or overtemperature failure).
---	--	---	---

Power Supply

The following table lists the specifications for each 770-W AC power supply used in the FMC 1600, 2600, and 4600.

Table 2: Power Supply Specifications

Description	Specification
Power consumption	1313 BTU/hr
AC input voltage range	Nominal range: 100 to 120 V AC, 200 to 240 V AC Range: 90–132 V AC, 180–264 V AC
AC input frequency	Nominal range: 50–60 Hz Range: 47–63 Hz
Maximum AC input current	9.5 A peak at 100-V AC 4.5 A peak at 208 V AC
Maximum input volt amperes	950 VA at 100 V AC
Maximum output power for each power supply	770 W
Maximum inrush current	15 A (subcycle duration)
Maximum hold-up time	12 ms at 770 W
Power supply output voltage	12 V DC
Power supply standby voltage	12 V DC
Efficiency rating	Climate Savers Platinum Efficiency (80 Plus Platinum certified)

Description	Specification
Form factor	RSP2
Input connector	IEC320 C13/C15

Hardware Specifications

The following table lists the hardware specifications for the FMC 1600, 2600, and 4600.

Table 3: FMC 1600, 2600, and 4600 Hardware Specifications

Specification	1600	2600	4600
Dimensions (H x W x D)	1.7 x 16.89 x 29.8 in. (4.32 x 43.0 x 75.6 cm)		
Weight	32.2 lb (16.6 kg)	34.1 lb (16.8 kg)	36.0 lb (17.0 kg)
Temperature	Operating: 50 to 95°F (10 to 35°C) Maximum temperature is derated by 1°F/547 ft (1°C/300 m) of altitude above 3117 ft (950 m). Nonoperating: -40 to 149°F (-40 to 65°C) When the appliance is stored or transported.		
Relative humidity	Operating: 8 to 90% noncondensing Nonoperating: 5 to 95% noncondensing		
Altitude	Operating: 0 to 10,000 ft Nonoperating: 0 to 40,000 ft when the appliance is stored or transported		
Sound power level	5.8 Bels (measure A-weighted per ISO7779 LWAd) Operation at 73°F (23°C)		
Sound pressure level	43 dBa (measure A-weighted per ISO7779 LpAM) Operation at 73°F (23°C)		

Product ID Numbers

The following table lists the field-replaceable PIDs associated with the FMC 1600, 2600, and 4600. The spare components are ones that you can order and replace yourself. If any internal components fail, you must get a return material authorization (RMA) for the entire chassis including the SFPs and SFP cables. Remove the drives and power supplies before you send the chassis for RMA. See the [Cisco Returns Portal](#) for more information.

Table 4: FMC 1600, 2600, and 4600 PIDs

PID	Description
FMC-M5-PS-AC-770W	AC power supply
FMC-M5-PS-AC-770W=	AC power supply (spare)
FMC-M5-HDD-1.2TB	FMC 1600 and 4600 1.2-TB drive
FMC-M5-HDD-1.2TB=	FMC 1600 and 4600 1.2-TB drive (spare)
FMC-M5-HDD-600G	FMC 2600 600-GB drive
FMC-M5-HDD-600G=	FMC 2600 600-GB drive (spare)
UCSC-RAILB-M4	Rail kit

Power Cord Specifications

Each power supply has a separate power cord. Standard power cords or jumper power cords are available for connection to the FMC 1600, 2600, and 4600. The jumper power cords for use in racks are available as an optional alternative to the standard power cords.

If you do not order the optional power cord with the system, you are responsible for selecting the appropriate power cord for the product. Using an incompatible power cord with this product may result in electrical safety hazard. Orders delivered to Argentina, Brazil, and Japan must have the appropriate power cord ordered with the system.



Note Only the approved power cords and jumper cords provided with the FMC 1600, 2600, and 4600 are supported.

The following power cords and jumper cords are supported.

Figure 10: Argentina (CAB-250V-10A-AR)

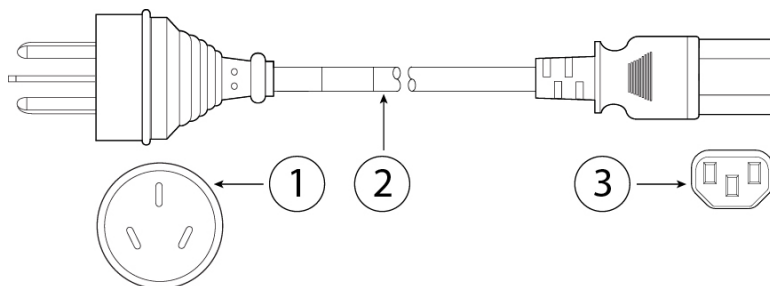

1	Plug: IRAM 2073	2	Cord set rating: 10 A, 250 V
3	Connector: IEC 60320/C13		—

Figure 11: Australia (CAB-9K10A-AU)

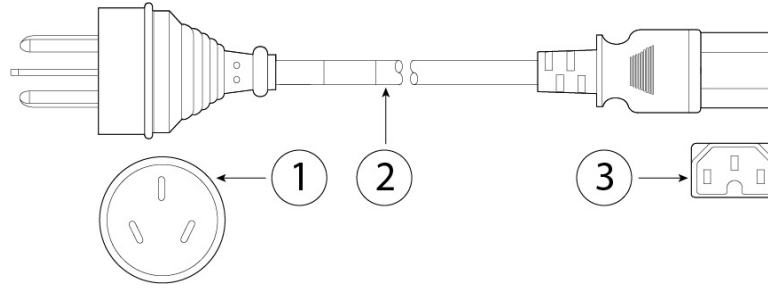

1	Plug: A.S. 3112-2000	2	Cord set rating: 10 A, 250 V
3	Connector: IEC 60320/C15		—

Figure 12: Brazil (PWR-250V-10A-BZ)

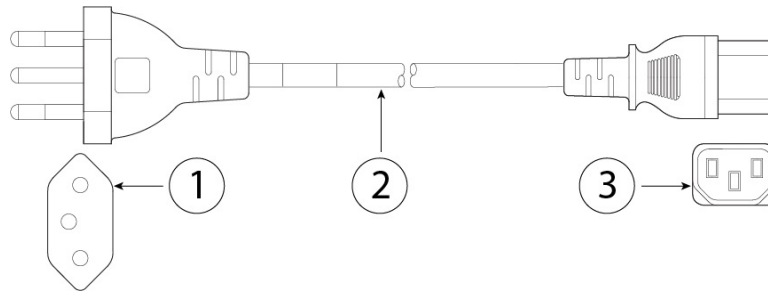

1	Plug: NBR 14136	2	Cord set rating: 10 A, 250 V
3	Connector: IEC 60320/C13		—

Figure 13: Cabinet Jumper (CAB-C13-C14-2M)

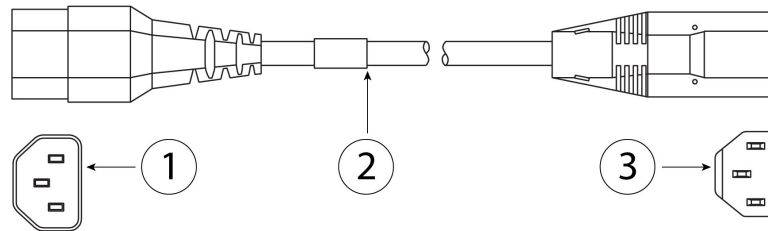

1	Plug: SS10A	2	Cord set rating: 10A, 250V
3	Connector: HS10S, C-13 to C-14		—

Figure 14: Cabinet Jumper (CAB-C13-C14-AC)

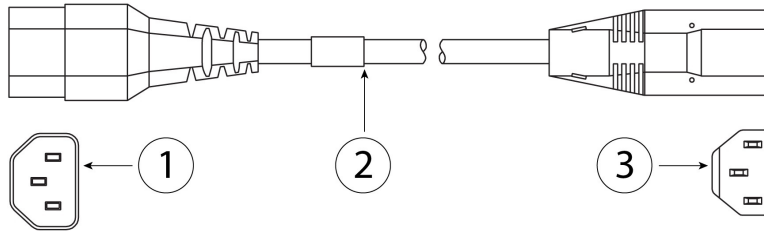

1	Plug: SS10A	2	Cord set rating: 10 A, 250 V
3	Connector: HS10S, C-13 to C-14 (recessed receptacle)		—

Figure 15: Cabinet Jumper (CAB-C13-CBN)

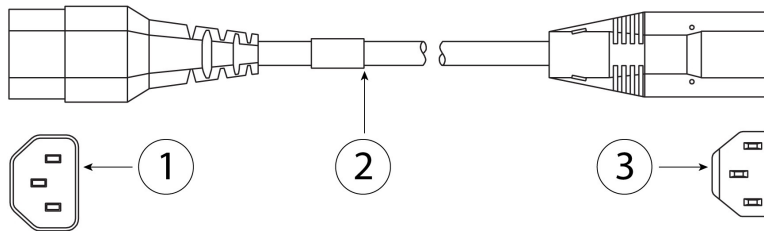

1	Plug: SS10A	2	Cord set rating: 10 A, 250 V
3	Connector: HS10S, C-13 to C-14		—

Figure 16: China (CAB-250V-10A-CH)

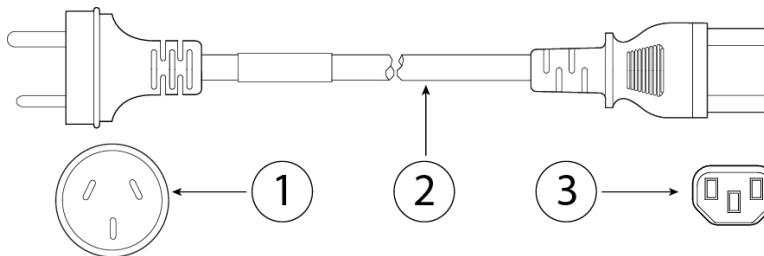

1	Plug: GB2099.1/2008	2	Cord set rating: 10 A, 250 V
3	Connector: IEC 60320/C13		—

Figure 17: Europe (CAB-9K10A-EU)

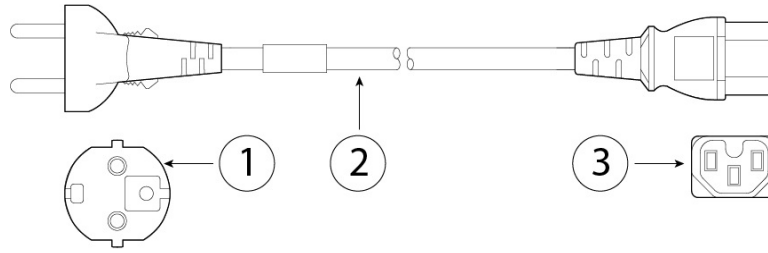

1	Plug: CEE 7/7 (M2511)	2	Cord set rating: 10 A/16 A, 250 V
3	Connector: IEC 60320/C15 (VSCC 15)		—

Figure 18: India (CAB-250V-10A-ID)

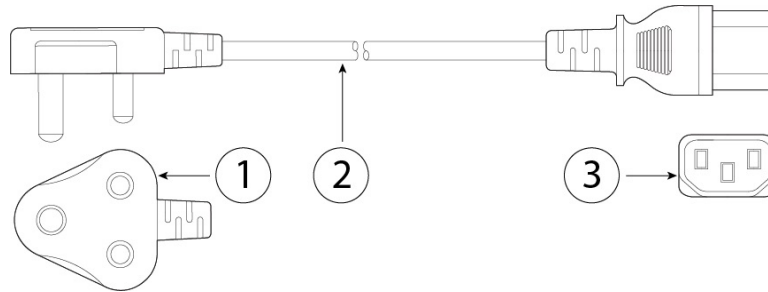

1	Plug: IS 6538-1971	2	Cord set rating: 16 A, 250 V
3	Connector: IEC 60320-C13		—

Figure 19: Israel (CAB-250V-10A-IS)

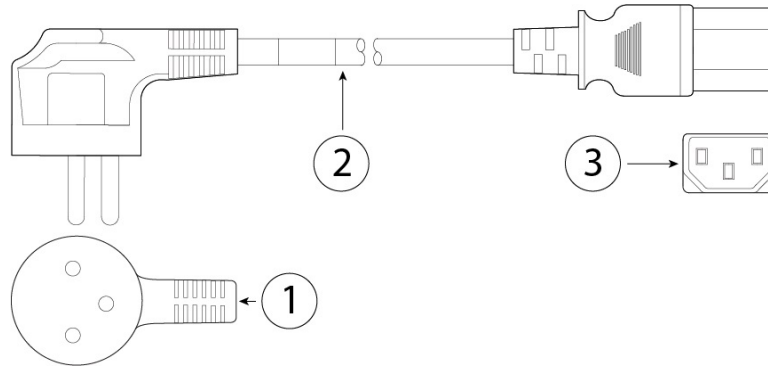

1	Plug: SI-32	2	Cord set rating: 10 A, 250 V
3	Connector: IEC 60320-C13		—

Figure 20: Italy (CAB-9K10A-IT)

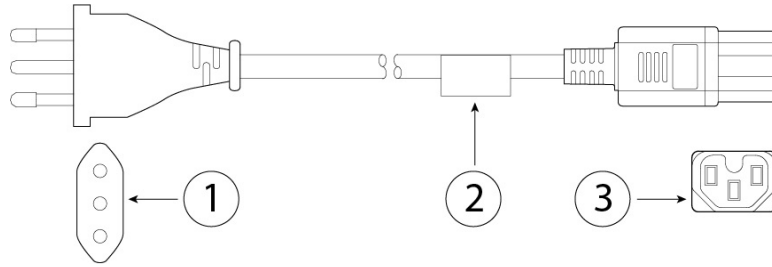

1	Plug: CEI 23-16/VII (I/3G)	2	Cord set rating: 10 A, 250 V
3	Connector: IEC 60320/C15 (EN 60320/C15M)		—

Figure 21: Japan (CAB-JPN-3PIN)

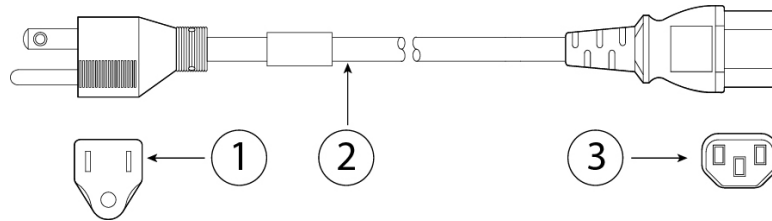

1	Plug: JIS 8303	2	Cord set rating: 12 A, 125 V
3	Connector: IEC 60320/C13		—

Figure 22: Japan (CAB-C13-C14-2M-JP)

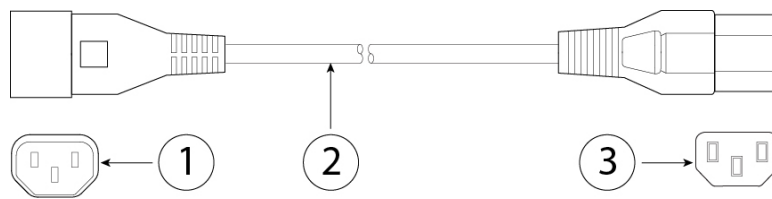

1	Plug: EN 60320-2-2/E	2	Cord set rating: 10 A, 250 V
3	Connector: EN 60320/C13 to C14		—

Figure 23: Korea (CAB-9K10S-KOR)

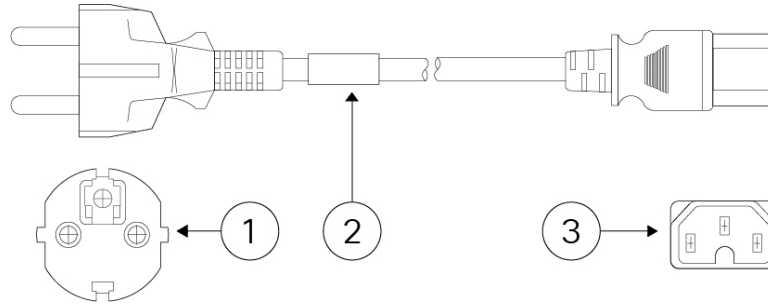

1	Plug: EL211 (KSC 8305)	2	Cord set rating: 10 A, 250 V
3	Connector: IEC 60320/C15		—

Figure 24: North America (CAB-9K12A-NA)

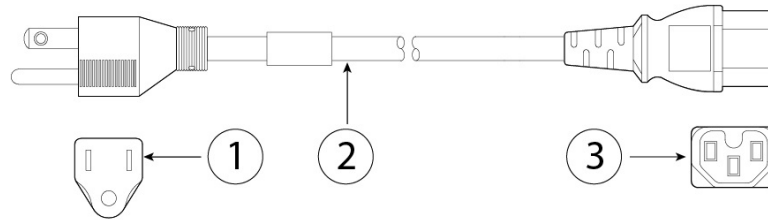

1	Plug: NEMA5-15P	2	Cord set rating: 13 A, 125 V
3	Connector: IEC 60320/C15		—

Figure 25: North America (CAB-N5K6A-NA)

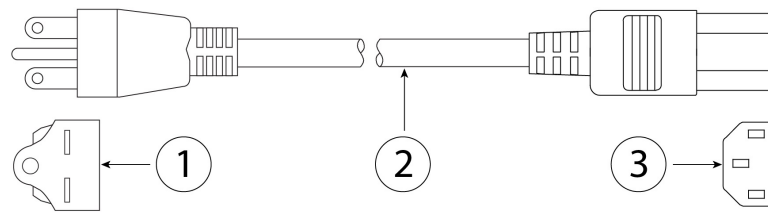

1	Plug: NEMA6-15P	2	Cord set rating: 10 A, 125 V
3	Connector: IEC 60320/C13		—

Figure 26: North America (CAB-AC-L620-C13)

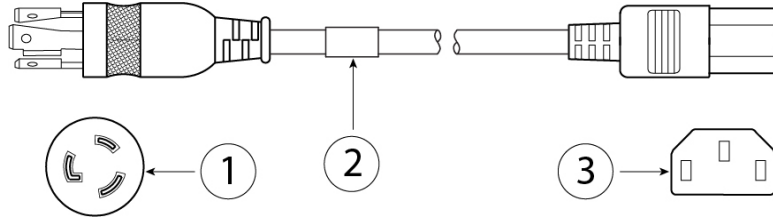

1	Plug: NEMA L6-20 (molded twist lock)	2	Cord set rating: 13 A, 250 V
3	Connector: IEC 60320/C13		—

Figure 27: Switzerland (CAB-9K10A-SW)

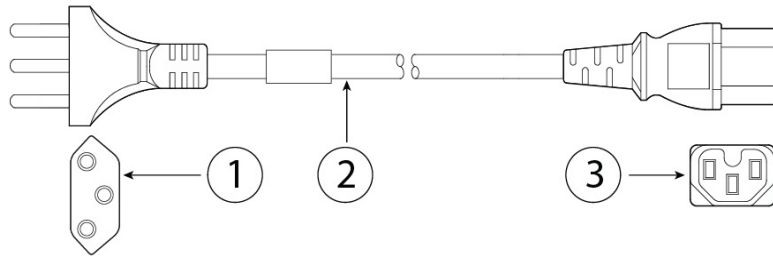

1	Plug: SEV 1011 (MP232-R)	2	Cord set rating: 10 A, 250 V
3	Connector: IEC 60320/C15		—

Figure 28: Taiwan (CAB-ACTW)

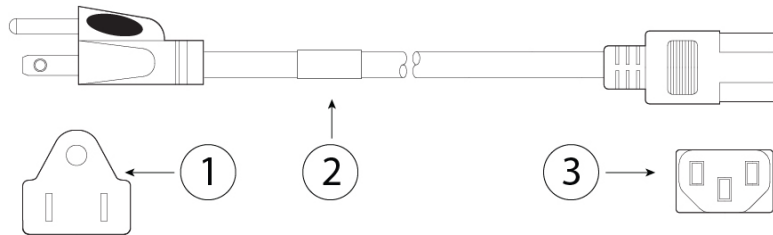

1	Plug: EL 302 (CNS10917)	2	Cord set rating: 10 A, 125 V
3	Connector: IEC 60320/C13		—

Figure 29: United Kingdom (CAB-9K10A-UK)

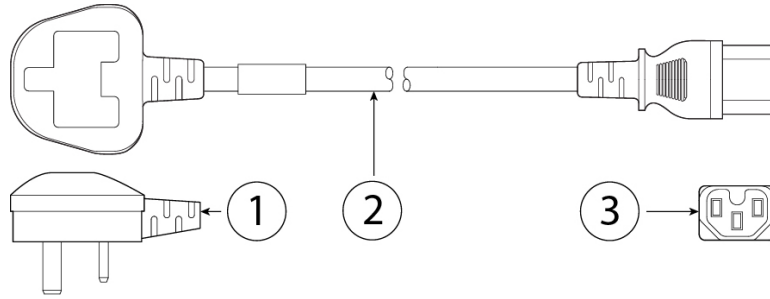

1	Plug: BS1363A/SS145	2	Cord set rating: 10 A, 250 V
3	Connector: IEC 60320/C15		—



CHAPTER 2

Installation Preparation

- [Installation Warnings, on page 25](#)
- [Safety Recommendations, on page 28](#)
- [Maintain Safety with Electricity, on page 28](#)
- [Prevent ESD Damage, on page 29](#)
- [Site Environment, on page 29](#)
- [Power Supply Considerations, on page 29](#)
- [Rack Configuration Considerations, on page 29](#)

Installation Warnings

Read the [Regulatory Compliance and Safety Information](#) document before installing the FMC.



Caution Do *not* open the appliance except under direction from TAC.

Take note of the following warnings:



Warning **Statement 1071**—Warning Definition

IMPORTANT SAFETY INSTRUCTIONS

Before you work on any equipment, be aware of the hazards involved with electrical circuitry and be familiar with standard practices for preventing accidents. Read the installation instructions before using, installing, or connecting the system to the power source. Use the statement number provided at the end of each warning statement to locate its translation in the translated safety warnings for this device.

SAVE THESE INSTRUCTIONS



**Warning Statement 371**—Power Cable and AC Adapter

When installing the product, use the provided or designated connection cables, power cables, AC adapters, and batteries. Using any other cables or adapters could cause a malfunction or a fire. Electrical Appliance and Material Safety Law prohibits the use of UL-certified cables (that have the "UL" or "CSA" shown on the cord), not regulated with the subject law by showing "PSE" on the cord, for any other electrical devices than products designated by Cisco.

**Note Statement 407**—Japanese Safety Instruction

You are strongly advised to read the safety instruction before using the product.

<https://www.cisco.com/web/JP/techdoc/pldoc/pldoc.html>

When installing the product, use the provided or designated connection cables/power cables/AC adapters.

《製品仕様における安全上のご注意》
シスコ製品をご使用になる前に安全上の注意をご確認ください。
<http://www.cisco.com/web/JP/techdoc/index.html>

接続ケーブル、電源コードセット、ACアダプタ、バッテリーなどの部品は、必ず添付品または指定品をご使用ください。添付品・指定品以外をご使用になると故障や動作不良、火災の原因となります。また、電源コードセットは弊社が指定する製品以外の電気機器には使用できないためご注意ください。

**Warning Statement 1004**—Installation Instructions

Read the installation instructions before using, installing, or connecting the system to the power source.

**Warning Statement 1005**—Circuit Breaker

This product relies on the building's installation for short-circuit (overcurrent) protection. Ensure that the protective device is rated not greater than: AC 20 A/DC 40 A

**Warning Statement 1015**—Battery Handling

To reduce risk of fire, explosion or leakage of flammable liquid or gas:

- Replace the battery only with the same or equivalent type recommended by the manufacturer.
- Do not dismantle, crush, puncture, use sharp tool to remove, short external contacts, or dispose of in fire.
- Do not use if battery is warped or swollen.
- Do not store or use battery in a temperature > 60° C.
- Do not store or use battery in low air pressure environment < 69.7 kPa.



Warning Statement 1029—Blank Faceplates and Cover Panels

Blank faceplates and cover panels serve three important functions: they reduce the risk of electric shock and fire, they contain electromagnetic interference (EMI) that might disrupt other equipment, and they direct the flow of cooling air through the chassis. Do not operate the system unless all cards, faceplates, front covers, and rear covers are in place.



Warning Statement 1030—Equipment Installation

Only trained and qualified personnel should be allowed to install, replace, or service this equipment.



Warning Statement 1040—Product Disposal

Ultimate disposal of this product should be handled according to all national laws and regulations.



Warning Statement 1073—No User-Serviceable Parts

There are no serviceable parts inside. To avoid risk of electric shock, do not open.



Warning Statement 1074—Comply with Local and National Electrical Codes

To reduce risk of electric shock or fire, installation of the equipment must comply with local and national electrical codes.



Warning Statement 1089—Instructed and Skilled Person Definitions

An instructed person is someone who has been instructed and trained by a skilled person and takes the necessary precautions when working with equipment.

A skilled person or qualified personnel is someone who has training or experience in the equipment technology and understands potential hazards when working with equipment.



Warning Statement 1090—Installation by Skilled Person

Only a skilled person should be allowed to install, replace, or service this equipment. See statement 1089 for the definition of a skilled person.



Warning **Statement 1091**—Installation by an Instructed Person

Only an instructed person or skilled person should be allowed to install, replace, or service this equipment. See statement 1089 for the definition of an instructed or skilled person.

Safety Recommendations

Observe these safety guidelines:

- Keep the area clear and dust free before, during, and after installation.
- Keep tools away from walkways, where you and others might trip over them.
- Do not wear loose clothing or jewelry, such as earrings, bracelets, or chains that could get caught in the chassis.
- Wear safety glasses if you are working under any conditions that might be hazardous to your eyes.
- Do not perform any action that creates a potential hazard to people or makes the equipment unsafe.
- Never attempt to lift an object that is too heavy for one person.

Maintain Safety with Electricity



Warning Before working on a chassis, be sure the power cord is unplugged.

Read the [Regulatory Compliance and Safety Information](#) document before installing the chassis.

Follow these guidelines when working on equipment powered by electricity:

- Before beginning procedures that require access to the interior of the chassis, locate the emergency power-off switch for the room in which you are working. Then, if an electrical accident occurs, you can act quickly to turn off the power.
- Do not work alone if potentially hazardous conditions exist anywhere in your work space.
- Never assume that power is disconnected; always check.
- Look carefully for possible hazards in your work area, such as moist floors, ungrounded power extension cables, frayed power cords, and missing safety grounds.
- Use the chassis within its marked electrical ratings and product usage instructions.
- The chassis is equipped with an AC-input power supply, which is shipped with a three-wire electrical cord with a grounding-type plug that fits into a grounding-type power outlet only. Do not circumvent this safety feature. Equipment grounding should comply with local and national electrical codes.

Prevent ESD Damage

ESD occurs when electronic components are improperly handled, and it can damage equipment and impair electrical circuitry, which can result in intermittent or complete failure of your equipment.

Always follow ESD-prevention procedures when removing and replacing components. Ensure that the chassis is electrically connected to an earth ground. Wear an ESD-preventive wrist strap, ensuring that it makes good skin contact. Connect the grounding clip to an unpainted surface of the chassis frame to safely ground ESD voltages. To properly guard against ESD damage and shocks, the wrist strap and cord must operate effectively. If no wrist strap is available, ground yourself by touching the metal part of the chassis.

For safety, periodically check the resistance value of the antistatic strap, which should be between one and 10 megohms.

Site Environment

See [Hardware Specifications, on page 15](#) for information about physical specifications.

To avoid equipment failures and reduce the possibility of environmentally caused shutdowns, plan the site layout and equipment locations carefully. If you are currently experiencing shutdowns or unusually high error rates with your existing equipment, these considerations may help you isolate the cause of failures and prevent future problems.

Power Supply Considerations

See [Power Supply, on page 14](#) for more detailed information about the power supply in the chassis.

When installing the chassis, consider the following:

- Check the power at the site before installing the chassis to ensure that it is free of spikes and noise. Install a power conditioner, if necessary, to ensure proper voltages and power levels in the appliance-input voltage.
- Install proper grounding for the site to avoid damage from lightning and power surges.
- The chassis does not have a user-selectable operating range. Refer to the label on the chassis for the correct appliance input-power requirement.
- Several styles of AC-input power supply cords are available for the chassis; make sure that you have the correct style for your site.
- If you are using dual redundant (1+1) power supplies, we recommend that you use independent electrical circuits for each power supply.
- Install an uninterruptible power source for your site, if possible.

Rack Configuration Considerations

See [Rack-Mount the Chassis, on page 31](#) for the procedure for rack-mounting the chassis.

Consider the following when planning a rack configuration:

- If you are mounting a chassis in an open rack, make sure that the rack frame does not block the intake or exhaust ports.
- If your rack includes closing front and rear doors, the doors must have 65 percent open perforated area evenly distributed from top to bottom to permit adequate airflow.
- Be sure enclosed racks have adequate ventilation. Make sure that the rack is not overly congested as each chassis generates heat. An enclosed rack should have louvered sides and a fan to provide cooling air.
- In an enclosed rack with a ventilation fan in the top, heat generated by equipment near the bottom of the rack can be drawn upward and into the intake ports of the equipment above it in the rack. Ensure that you provide adequate ventilation for equipment at the bottom of the rack.
- Baffles can help to isolate exhaust air from intake air, which also helps to draw cooling air through the chassis. The best placement of the baffles depends on the airflow patterns in the rack. Experiment with different arrangements to position the baffles effectively.



CHAPTER 3

Rack-Mount the Chassis

- [Unpack and Inspect the Chassis, on page 31](#)
- [Rack-Mount the Chassis, on page 31](#)

Unpack and Inspect the Chassis



Note The chassis is thoroughly inspected before shipment. If any damage occurred during transportation or any items are missing, contact your customer service representative immediately. Keep the shipping container in case you need to send the chassis back due to damage.

See [Package Contents, on page 4](#) for a list of what shipped with the chassis.

- Step 1** Remove the chassis from its cardboard container and save all packaging material.
- Step 2** Compare the shipment to the equipment list provided by your customer service representative. Verify that you have all items.
- Step 3** Check for damage and report any discrepancies or damage to your customer service representative. Have the following information ready:
- Invoice number of shipper (see the packing slip)
 - Model and serial number of the damaged unit
 - Description of damage
 - Effect of damage on the installation
-

Rack-Mount the Chassis

You can install the chassis in a rack using the Cisco rack kit.

The rack must be of the following type:

- A standard 19-inch (48.3-cm) wide, 4-post EIA rack with mounting posts that conform to English universal hole spacing per section 1 of ANSI/EIA-310-D-1992.
- The rack post holes can be square 0.38-inch (9.6 mm), round 0.28-inch (7.1 mm), #12-24 UNC, or #10-32 UNC when you use the supplied slide rails.
- The minimum vertical rack space per chassis must be 1 RU, equal to 1.75 inch (44.45 mm).
- The slide rails for the chassis have an adjustment range of 24 to 36 inch (610 to 914 mm).



Note The slide rails supplied by Cisco Systems for the chassis do not require tools for installation if you install them in a rack that has square 0.38-inch (9.6 mm), round 0.28-inch (7.1 mm), or #12-24 UNC threaded holes.

Safety Warnings

Take note of the following warning:



Note **Statement 164**—Lifting Requirement

Two people are required to lift the heavy parts of the product. To prevent injury, keep your back straight and lift with your legs, not your back.



Warning **Statement 1006**—Chassis Warning for Rack-Mounting and Servicing

To prevent bodily injury when mounting or servicing this unit in a rack, you must take special precautions to ensure that the system remains stable. The following guidelines are provided to ensure your safety:

- This unit should be mounted at the bottom of the rack if it is the only unit in the rack.
 - When mounting this unit in a partially filled rack, load the rack from the bottom to the top with the heaviest component at the bottom of the rack.
 - If the rack is provided with stabilizing devices, install the stabilizers before mounting or servicing the unit in the rack.
-



Warning **Statement 1032**—Lifting the Chassis

To prevent personal injury or damage to the chassis, never attempt to lift or tilt the chassis using the handles on modules, such as power supplies, fans, or cards. These types of handles are not designed to support the weight of the unit.



Note **Statement 1047**—Overheating Prevention

To reduce the risk of fire or bodily injury, do not operate the unit in an area that exceeds the maximum recommended ambient temperature of: 104°F/40°C

Step 1 Attach the inner rails to the sides of the chassis:

- a) Align an inner rail with one side of the chassis so that the three keyed slots in the rail align with the three pegs on the side of the chassis.
- b) Set the keyed slots over the pegs, and then slide the rail toward the front to lock it in place on the pegs. The front slot has a metal clip that locks over the front peg.
- c) Install the second inner rail to the opposite side of the chassis.

Figure 30: Attach the Inner Rail to Side of Chassis

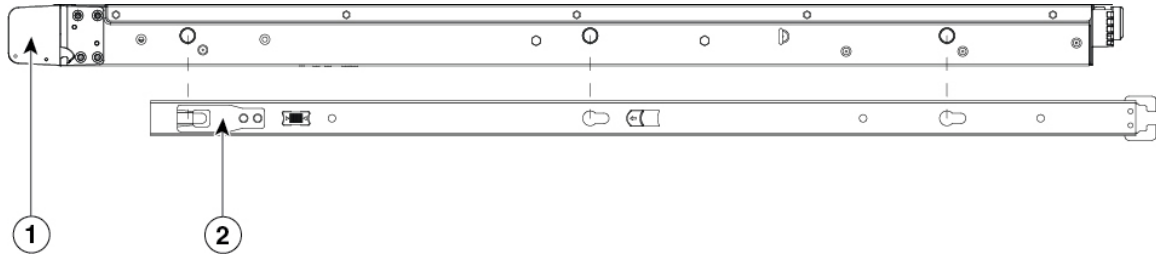

1	Front of chassis	2	Locking clip on inner rail
---	------------------	---	----------------------------

Step 2 Open the front securing plate on both slide-rail assemblies. The front end of the slide-rail assembly has a spring-loaded securing plate that must be open before you can insert the mounting pegs into the rack-post holes.

On the outside of the assembly, push the green arrow button toward the rear to open the securing plate.

Figure 31: Front Securing Mechanism, Inside of Front End

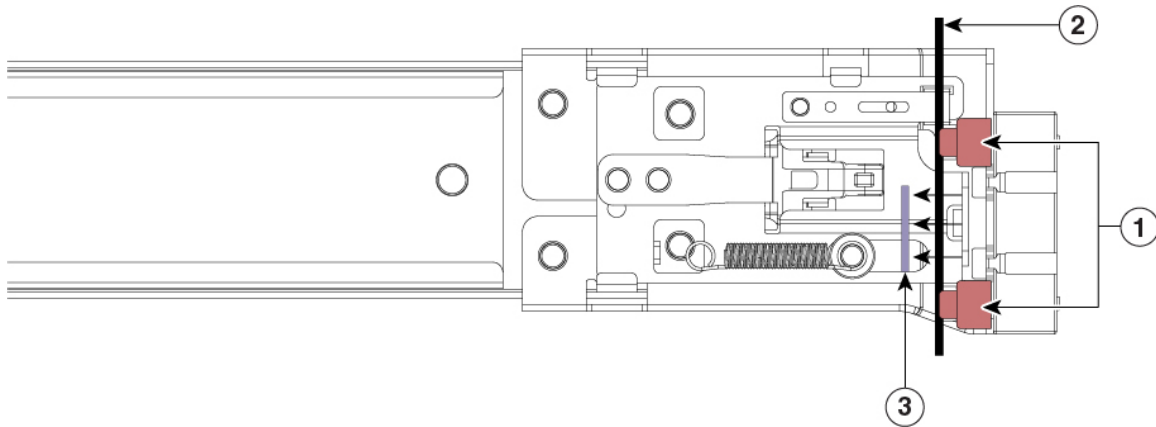

1	Front mounting pegs	2	Rack post
3	Securing plate shown pulled back to open position		

Step 3 Install the slide rails into the rack:

- a) Align one slide-rail assembly front end with the front rack-post holes that you want to use.
The slide rail front end wraps around the outside of the rack post and the mounting pegs enter the rack-post holes from the outside-front.

Note The rack post must be between the mounting pegs and the open securing plate.

- b) Push the mounting pegs into the rack-post holes from the outside-front.
- c) Press the securing plate release button, labeled PUSH. The spring-loaded securing plate closes to lock the pegs in place.
- d) Attach the second slide-rail assembly to the opposite side of the rack. Make sure that the two slide-rail assemblies are at the same height with each other and are level front-to-back.
- e) Pull the inner slide rails on each assembly out toward the rack front until they hit the internal stops and lock in place.

Step 4

Insert the chassis into the slide rails:

- a) Align the rear of the inner rails that are attached to the chassis sides with the front ends of the empty slide rails on the rack.
- b) Push the inner rails into the slide rails on the rack until they stop at the internal stops.
- c) Slide the release clip toward the rear on both inner rails, and then continue pushing the chassis into the rack until its front slam latches engage with the rack posts

Figure 32: Inner Rail Release Clip

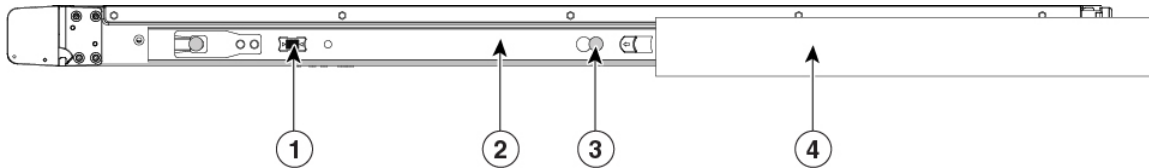

1	Inner rail release clip	2	Inner rail attached to the chassis and inserted into outer rail
3	Button to unlock rail Press this button to unlock the rail so you can pull out the chassis from the rack when uninstalling or performing maintenance.	4	Outer rail attached to rack post

Step 5

(Optional) Secure the chassis in the rack more permanently by using the two screws that are provided with the slide rails. Perform this step if you plan to move the rack with chassis installed. With the chassis fully pushed into the slide rails, open a hinged slam latch lever on the front of the chassis and insert the screw through the hole that is under the lever. The screw threads into the static part of the rail on the rack post and prevents the chassis from being pulled out. Repeat for the opposite slam latch.

What to do next

Continue with the [Connect Cables](#), [Turn on Power](#), and [Verify Status](#) topics in the [Cisco Firepower Management Center Getting Started Guide for Models 1600, 2600, and 4600](#).



CHAPTER 4

Installation, Maintenance, and Upgrade

- [Power Button Shutdown, on page 35](#)
- [Remove and Replace a Drive, on page 36](#)
- [Remove and Replace a Power Supply, on page 39](#)

Power Button Shutdown

The FMC runs in two modes:

- Main power mode—Power is supplied to all FMC components and all operating systems can run.
- Standby power mode—Power is supplied only to the service processor and certain components. You can safely remove power cords from the FMC in this mode.



Caution After you shut down the FMC to standby power, electric current is still present in the chassis. To completely remove power as directed in some maintenance procedures, you must disconnect all power cords from all power supplies on the FMC.

You can shut down the FMC using the front panel Power button or software management. See the system shutdown procedure in the [Firepower Management Center Configuration Guide](#) for your version for the software procedures.

Step 1 Check the Power LED:

- Amber—The FMC is already in standby mode and you can safely remove power.
- Green—The FMC is in main power mode and you must shut it down before you can safely remove power.

Step 2 Perform a graceful shutdown or a hard shutdown:

Caution To avoid data loss or damage to your operating system, perform a graceful shutdown of the operating system.

- Graceful shutdown—Press and release the Power button. The operating system performs a graceful shutdown and the FMC goes into standby mode. The power LED is amber.

- Emergency shutdown—Press and hold the Power button for four seconds to force the main power off and immediately enter standby mode.

Remove and Replace a Drive



Note The drives are hot-swappable. You do not have to shut down the FMC to remove or replace drives.



Note You cannot add more drives to your FMC. You can only replace the drives in the slots that are supported for your model. See [Front Panel, on page 6](#) for the drive configurations.

Safety Warnings

Take note of the following warnings:



Warning Statement 1028—More Than One Power Supply

This unit might have more than one power supply connection. To reduce risk of electric shock, remove all connections to de-energize the unit.



Warning Statement 1030—Equipment Installation

Only trained and qualified personnel should be allowed to install, replace, or service this equipment.



Warning Statement 1073—No User-Serviceable Parts

There are no serviceable parts inside. To avoid risk of electric shock, do not open.

**Warning Statement 1089**—Instructed and Skilled Person Definitions

An instructed person is someone who has been instructed and trained by a skilled person and takes the necessary precautions when working with equipment.

A skilled person or qualified personnel is someone who has training or experience in the equipment technology and understands potential hazards when working with equipment.

**Warning Statement 1090**—Installation by Skilled Person

Only a skilled person should be allowed to install, replace, or service this equipment. See statement 1089 for the definition of a skilled person.

**Warning Statement 1091**—Installation by an Instructed Person

Only an instructed person or skilled person should be allowed to install, replace, or service this equipment. See statement 1089 for the definition of an instructed or skilled person.

Step 1

Remove the drive that you are replacing:

- a) Press the release button on the face of the drive tray.
- b) Grasp and open the ejector handle and then pull the drive tray out of the slot.

Figure 33: Remove the Drive

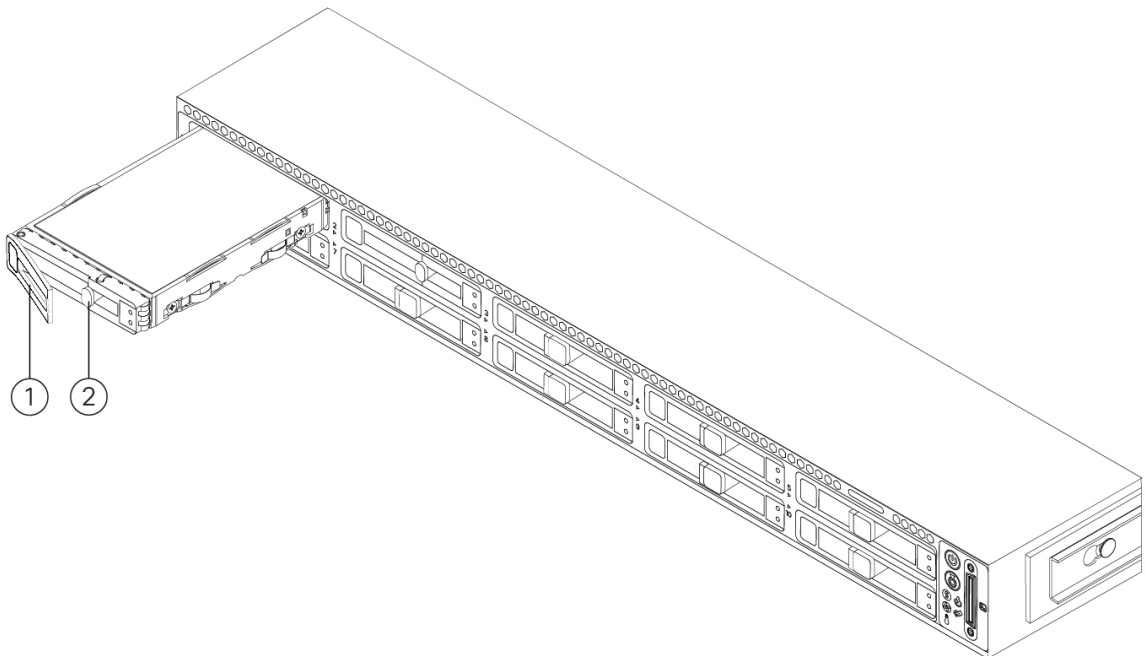

1	Ejector handle	2	Release button
---	----------------	---	----------------

Step 2 Remove the four drive-tray screws that secure the drive to the tray and then lift the drive out of the tray.

Figure 34: Remove the Drive Tray

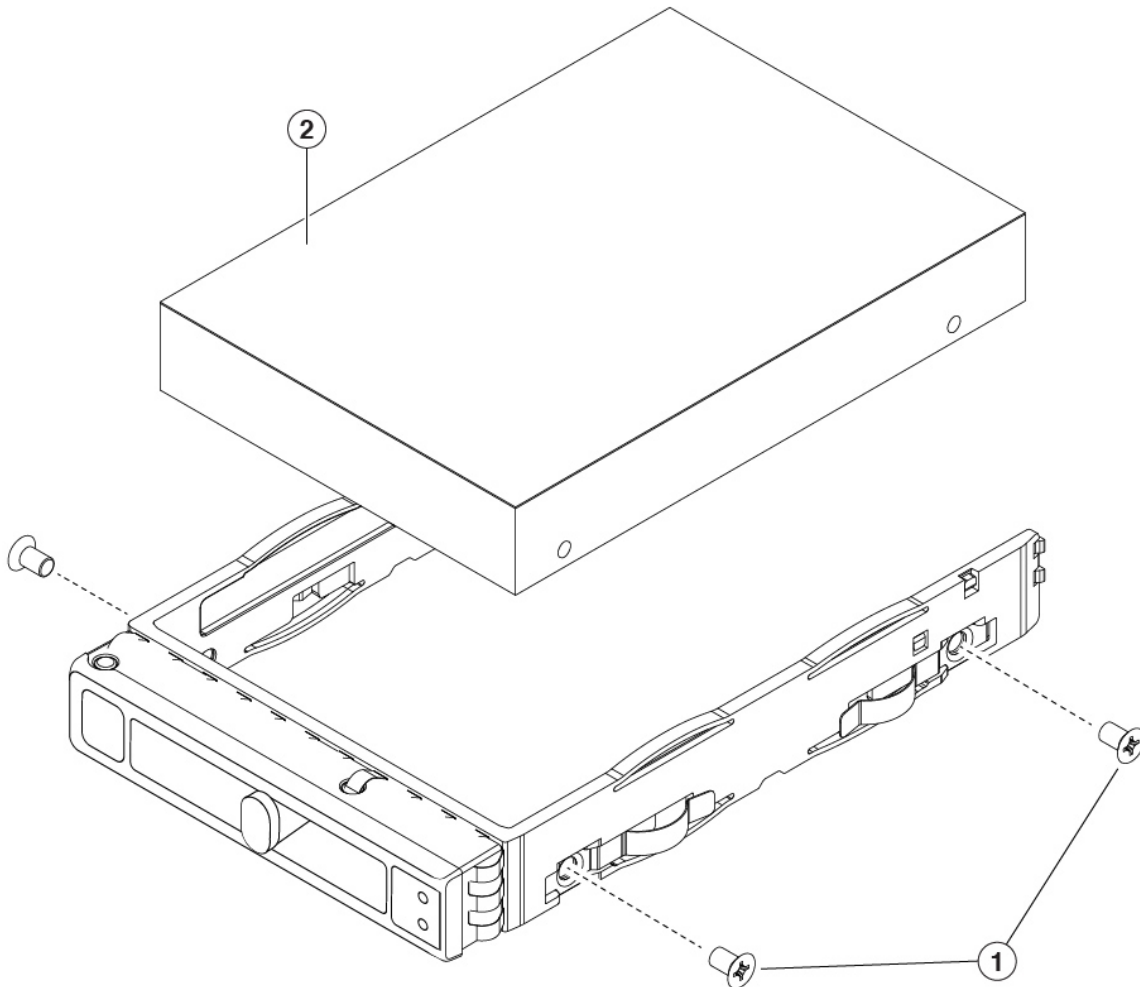

1	Drive tray screws (two on each side)	2	Drive removed from drive tray
---	--------------------------------------	---	-------------------------------

Step 3 Install a new drive:

- Place a new drive in the empty drive tray and install the four drive-tray screws.
- With the ejector handle on the drive tray open, insert the drive tray into the empty drive bay.
- Push the tray into the slot until it touches the backplane, and then close the ejector handle to lock the drive in place.

Remove and Replace a Power Supply

The FMC ships with two power supplies, which are redundant and hot-swappable. One is the active power supply and the other is the standby power supply (1+1).

This FMC also supports cold redundancy. Depending on the power being drawn by the FMC, one power supply might actively provide all power to the system while the remaining power supply is put into a standby state. For example, if the power consumption can be satisfied by power supply 1, then power supply 2 is put into a standby state.



Caution When you replace power supplies, do not mix power supply types in the FMC. Both power supplies must be the same wattage and Cisco PID.



Trouble Power supply health monitoring notifies you if the power supply loses power or malfunctions so that redundancy is lost. Check the power supply cables to make sure they are functioning. If they are and errors are still occurring, replace the power supply.

Safety Warnings

Take note of the following warnings:



Warning **Statement 1005**—Circuit Breaker

This product relies on the building's installation for short-circuit (overcurrent) protection. Ensure that the protective device is rated not greater than: AC 20 A/DC 40 A



Warning **Statement 1017**—Restricted Area

This unit is intended for installation in restricted access areas. Only skilled, instructed, or qualified personnel can access a restricted access area.



Warning **Statement 1018**—Supply Circuit

To reduce risk of electric shock and fire, take care when connecting units to the supply circuit so that wiring is not overloaded.



Warning **Statement 1022**—Disconnect Device

To reduce risk of electric shock and fire, a readily accessible two-poled disconnect device must be incorporated in the fixed wiring.



Warning **Statement 1028**—More Than One Power Supply

This unit might have more than one power supply connection. To reduce risk of electric shock, remove all connections to de-energize the unit.



Warning **Statement 1029**—Blank Faceplates and Cover Panels

Blank faceplates and cover panels serve three important functions: they reduce the risk of electric shock and fire, they contain electromagnetic interference (EMI) that might disrupt other equipment, and they direct the flow of cooling air through the chassis. Do not operate the system unless all cards, faceplates, front covers, and rear covers are in place.



Warning **Statement 1030**—Equipment Installation

Only trained and qualified personnel should be allowed to install, replace, or service this equipment.



Warning **Statement 1046**—Installing or Replacing the Unit

To reduce risk of electric shock, when installing or replacing the unit, the ground connection must always be made first and disconnected last.



Warning **Statement 1073**—No User-Serviceable Parts

There are no serviceable parts inside. To avoid risk of electric shock, do not open.



Warning **Statement 1089**—Instructed and Skilled Person Definitions

An instructed person is someone who has been instructed and trained by a skilled person and takes the necessary precautions when working with equipment.

A skilled person or qualified personnel is someone who has training or experience in the equipment technology and understands potential hazards when working with equipment.

**Warning Statement 1090**—Installation by Skilled Person

Only a skilled person should be allowed to install, replace, or service this equipment. See statement 1089 for the definition of a skilled person.

**Warning Statement 1091**—Installation by an Instructed Person

Only an instructed person or skilled person should be allowed to install, replace, or service this equipment. See statement 1089 for the definition of an instructed or skilled person.

Step 1

Remove the power supply:

- a) Grasp the power supply handle while pinching the release lever toward the handle.
- b) Pull the power supply out of the bay.

Figure 35: Remove and Replace the AC Power Supply 429121

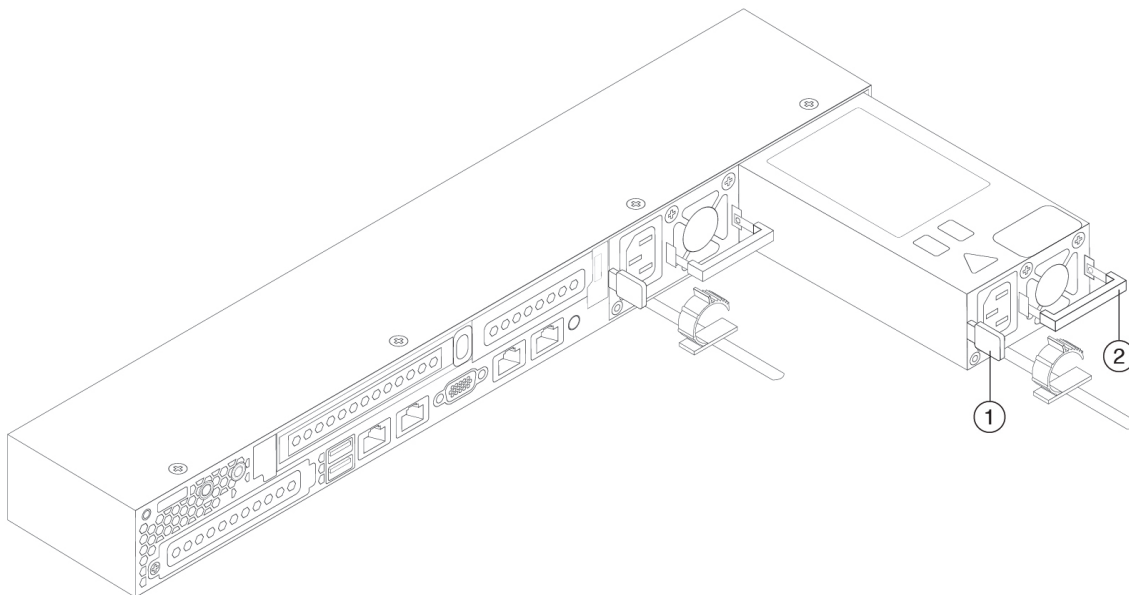

1	Release lever	2	Handle
----------	---------------	----------	--------

Step 2

Install a new power supply:

- a) Grasp the power supply handle and insert the new power supply into the empty bay.
- b) Push the power supply into the bay until the release lever locks.
- c) Connect the power cord to the new power supply.
- d) If you shut down the FMC, press the Power button to return it to main power mode.

