

# vSRX Virtual Firewall Deployment Guide for Private and Public Cloud Platforms

Published  
2023-11-09

Juniper Networks, Inc.  
1133 Innovation Way  
Sunnyvale, California 94089  
USA  
408-745-2000  
www.juniper.net

Juniper Networks, the Juniper Networks logo, Juniper, and Junos are registered trademarks of Juniper Networks, Inc. in the United States and other countries. All other trademarks, service marks, registered marks, or registered service marks are the property of their respective owners.

Juniper Networks assumes no responsibility for any inaccuracies in this document. Juniper Networks reserves the right to change, modify, transfer, or otherwise revise this publication without notice.

*vSRX Virtual Firewall Deployment Guide for Private and Public Cloud Platforms*  
Copyright © 2023 Juniper Networks, Inc. All rights reserved.

The information in this document is current as of the date on the title page.

## YEAR 2000 NOTICE

Juniper Networks hardware and software products are Year 2000 compliant. Junos OS has no known time-related limitations through the year 2038. However, the NTP application is known to have some difficulty in the year 2036.

## END USER LICENSE AGREEMENT

The Juniper Networks product that is the subject of this technical documentation consists of (or is intended for use with) Juniper Networks software. Use of such software is subject to the terms and conditions of the End User License Agreement ("EULA") posted at <https://support.juniper.net/support/eula/>. By downloading, installing or using such software, you agree to the terms and conditions of that EULA.

# Table of Contents

1

[About This Guide | xvii](#)

## [vSRX Virtual Firewall Deployment for KVM](#)

[Overview | 2](#)

[Understand vSRX Virtual Firewall with KVM | 2](#)

[Requirements for vSRX Virtual Firewall on KVM | 7](#)

### [Install vSRX Virtual Firewall in KVM | 19](#)

[Prepare Your Server for vSRX Virtual Firewall Installation | 19](#)

[Enable Nested Virtualization | 19](#)

[Upgrade the Linux Kernel on Ubuntu | 21](#)

[Install vSRX Virtual Firewall with KVM | 21](#)

[Install vSRX Virtual Firewall with virt-manager | 22](#)

[Install vSRX Virtual Firewall with virt-install | 24](#)

[Example: Install and Launch vSRX Virtual Firewall on Ubuntu | 27](#)

[Requirements | 28](#)

[Overview | 28](#)

[Quick Configuration - Install and Launch a vSRX Virtual Firewall VM on Ubuntu | 29](#)  
[| 32](#)

[Step by Step Configuration | 32](#)

[Load an Initial Configuration on a vSRX Virtual Firewall with KVM | 45](#)

[Create a vSRX Virtual Firewall Bootstrap ISO Image | 46](#)

[Provision vSRX Virtual Firewall with an ISO Bootstrap Image on KVM | 47](#)

[Use Cloud-Init in an OpenStack Environment to Automate the Initialization of vSRX Virtual Firewall Instances | 48](#)

[Perform Automatic Setup of a vSRX Virtual Firewall Instance Using an OpenStack Command-Line Interface | 52](#)

[Perform Automatic Setup of a vSRX Virtual Firewall Instance from the OpenStack Dashboard \(Horizon\) | 54](#)

[vSRX Virtual Firewall VM Management with KVM | 62](#)

- Configure vSRX Virtual Firewall Using the CLI | 62
- Connect to the vSRX Virtual Firewall Management Console on KVM | 64
- Add a Virtual Network to a vSRX Virtual Firewall VM with KVM | 65
- Add a Virtio Virtual Interface to a vSRX Virtual Firewall VM with KVM | 67
- SR-IOV and PCI | 69
  - SR-IOV Overview | 69
  - SR-IOV HA Support with Trust Mode Disabled (KVM only) | 70
    - Understand SR-IOV HA Support with Trust Mode Disabled (KVM only) | 70
    - Configure SR-IOV support with Trust Mode Disabled (KVM only) | 72
    - Limitations | 73
  - Configure an SR-IOV Interface on KVM | 74
- Upgrade a Multi-core vSRX Virtual Firewall | 78
  - Configure the Queue Value for vSRX Virtual Firewall VM with KVM | 78
  - Shutdown the vSRX Virtual Firewall Instance with virt-manager | 79
  - Upgrade vSRX Virtual Firewall with virt-manager | 79
- Monitor the vSRX Virtual Firewall VM in KVM | 81
- Manage the vSRX Virtual Firewall Instance on KVM | 82
  - Power On the vSRX Virtual Firewall Instance with virt-manager | 82
  - Power On the vSRX Virtual Firewall Instance with virsh | 82
  - Pause the vSRX Virtual Firewall Instance with virt-manager | 83
  - Pause the vSRX Virtual Firewall Instance with virsh | 83
  - Rebooting the vSRX Virtual Firewall Instance with virt-manager | 83
  - Reboot the vSRX Virtual Firewall Instance with virsh | 83
  - Power Off the vSRX Virtual Firewall Instance with virt-manager | 84
  - Power Off the vSRX Virtual Firewall Instance with virsh | 84
  - Shutdown the vSRX Virtual Firewall Instance with virt-manager | 85
  - Shutdown the vSRX Virtual Firewall Instance with virsh | 85
  - Remove the vSRX Virtual Firewall Instance with virsh | 86
- Recover the Root Password for vSRX Virtual Firewall in a KVM Environment | 87
- Configure vSRX Virtual Firewall Chassis Clusters on KVM | 89**
  - vSRX Virtual Firewall Cluster Staging and Provisioning for KVM | 89

- Chassis Cluster Provisioning on vSRX Virtual Firewall | 89
- Creating the Chassis Cluster Virtual Networks with virt-manager | 91
- Creating the Chassis Cluster Virtual Networks with virsh | 91
- Configuring the Control and Fabric Interfaces with virt-manager | 93
- Configuring the Control and Fabric Interfaces with virsh | 93
- Configuring Chassis Cluster Fabric Ports | 93

Configure a vSRX Virtual Firewall Chassis Cluster in Junos OS | 94

- Chassis Cluster Overview | 95
- Enable Chassis Cluster Formation | 96
- Chassis Cluster Quick Setup with J-Web | 97
- Manually Configure a Chassis Cluster with J-Web | 98

Verify the Chassis Cluster Configuration | 105

2

## **vSRX Virtual Firewall Deployment for VMware**

**Overview | 107**

Understand vSRX Virtual Firewall with VMware | 107

Requirements for vSRX Virtual Firewall on VMware | 115

**Install vSRX Virtual Firewall in VMware | 124**

Install vSRX Virtual Firewall with VMware vSphere Web Client | 124

Load an Initial Configuration on a vSRX Virtual Firewall with VMware | 128

- Create a vSRX Virtual Firewall Bootstrap ISO Image | 132
- Upload an ISO Image to a VMWare Datastore | 133
- Provision vSRX Virtual Firewall with an ISO Bootstrap Image on VMWare | 134

Validate the vSRX Virtual Firewall .ova File for VMware | 135

**vSRX Virtual Firewall VM Management with VMware | 139**

Add vSRX Virtual Firewall Interfaces | 139

- Add SR-IOV Interfaces | 140
- Add VMXNET 3 Interfaces | 142

Upgrade a Multicore vSRX Virtual Firewall with VMware | 142

- Power Down vSRX Virtual Firewall VM with VMware vSphere Web Client | 143
- Upgrade a Multicore vSRX Virtual Firewall with VMware vSphere Web Client | 143
- Optimize Performance of vSRX Virtual Firewall | 144

Automate the Initialization of vSRX Virtual Firewall 3.0 Instances on VMware Hypervisor using VMware Tools | 145

Overview | 145

Provision VMware Tools for Autoconfiguration | 146

## Configure vSRX Virtual Firewall Chassis Clusters in VMware | 150

vSRX Virtual Firewall Cluster Staging and Provisioning for VMware | 150

Deploying the VMs and Additional Network Interfaces | 150

Creating the Control Link Connection Using VMware | 151

Creating the Fabric Link Connection Using VMware | 155

Creating the Data Interfaces Using VMware | 158

Prestaging the Configuration from the Console | 159

Connecting and Installing the Staging Configuration | 160

Configure a vSRX Virtual Firewall Chassis Cluster in Junos OS | 161

Chassis Cluster Overview | 161

Enable Chassis Cluster Formation | 162

Chassis Cluster Quick Setup with J-Web | 167

Manually Configure a Chassis Cluster with J-Web | 168

Deploy vSRX Virtual Firewall Chassis Cluster Nodes Across Different ESXi Hosts Using dvSwitch | 174

## 3

## vSRX Virtual Firewall Deployment for Microsoft Hyper-V

Overview | 179

Understand vSRX Virtual Firewall with Microsoft Hyper-V | 179

Requirements for vSRX Virtual Firewall on Microsoft Hyper-V | 181

Install vSRX Virtual Firewall in Microsoft Hyper-V | 188

Prepare for vSRX Virtual Firewall Deployment in Microsoft Hyper-V | 188

Deploy vSRX Virtual Firewall in a Hyper-V Host Using the Hyper-V Manager | 189

Deploy vSRX Virtual Firewall in a Hyper-V Host Using Windows PowerShell | 200

vSRX Virtual Firewall VM Management with Microsoft Hyper-V | 205

Configure vSRX Virtual Firewall Using the CLI | 205

Configure vSRX Virtual Firewall Using the J-Web Interface | 207

Access the J-Web Interface and Configuring vSRX Virtual Firewall | 207

- Apply the Configuration | 210
- Add vSRX Virtual Firewall Feature Licenses | 210

#### Add vSRX Virtual Firewall Interfaces | 211

- Add Virtual Switches | 212
- Configure the vSRX Virtual Firewall to Use a VLAN | 219

#### Power Down a vSRX Virtual Firewall VM with Hyper-V | 221

### Configure vSRX Virtual Firewall Chassis Clusters | 222

#### vSRX Virtual Firewall Cluster Staging and Provisioning in Hyper-V | 222

- Deploying the VMs and Additional Network Adapters in Hyper-V | 223
- Creating the Control Link Connection in Hyper-V | 223
- Creating the Fabric Link Connection in Hyper-V | 226
- Creating the Data Interfaces Using Hyper-V | 227
- Prestaging the Configuration from the Console | 228
- Connecting and Installing the Staging Configuration | 229

#### Configure a vSRX Virtual Firewall Chassis Cluster in Junos OS | 230

- Chassis Cluster Overview | 230
- Enable Chassis Cluster Formation | 231
- Chassis Cluster Quick Setup with J-Web | 237
- Manually Configure a Chassis Cluster with J-Web | 237

## 4

### vSRX Virtual Firewall Deployment for Contrail

#### Overview of vSRX Virtual Firewall Service Chains in Contrail | 245

##### Understand vSRX Virtual Firewall with Contrail | 245

##### Requirements for vSRX Virtual Firewall on Contrail | 247

##### Overview of Service Chains with vSRX Virtual Firewall | 256

#### Spawn vSRX Virtual Firewall in a Contrail Service Chain | 259

- Create a Service Template | 259
- Create Left and Right Virtual Networks | 262
- Create a vSRX Virtual Firewall Service Instance | 263
- Create a Network Policy | 263
- Add a Network Policy to a Virtual Network | 264

#### Install vSRX Virtual Firewall in Contrail | 267

Enable Nested Virtualization | 267

Create an Image Flavor with OpenStack | 269

    Create an Image Flavor for vSRX Virtual Firewall with Horizon | 269

    Create an Image Flavor for vSRX Virtual Firewall with the Nova CLI | 272

Upload the vSRX Virtual Firewall Image | 273

    Upload the vSRX Virtual Firewall Image with OpenStack Horizon | 273

    Upload the vSRX Virtual Firewall Image with the OpenStack Glance CLI | 276

Use Cloud-Init in an OpenStack Environment to Automate the Initialization of vSRX Virtual Firewall Instances | 277

    Perform Automatic Setup of a vSRX Virtual Firewall Instance Using an OpenStack Command-Line Interface | 280

    Perform Automatic Setup of a vSRX Virtual Firewall Instance from the OpenStack Dashboard (Horizon) | 282

**vSRX Virtual Firewall VM Management with Contrail | 291**

Connect to the vSRX Virtual Firewall Management Console | 291

    Connect to the vSRX Virtual Firewall Management Console with Horizon | 291

    Connect to the vSRX Virtual Firewall Management Console with Contrail | 291

Manage the vSRX Virtual Firewall VM | 292

    Power On the VM from OpenStack | 292

    Pause the VM | 293

    Restart the VM | 293

    Power Off the VM from OpenStack | 293

    Delete the vSRX Virtual Firewall VM from Contrail | 293

Upgrade Multicore vSRX Virtual Firewall with Contrail | 294

    Configure Multi-queue Virtio Interface for vSRX Virtual Firewall VM with OpenStack | 294

    Modify an Image Flavor for vSRX Virtual Firewall with the Dashboard | 295

    Update a Service Template | 296

Monitor vSRX Virtual Firewall with Contrail | 297

## 5

**vSRX Virtual Firewall Deployment for Nutanix**

**Overview | 299**

Understand vSRX Virtual Firewall Deployment with Nutanix | 299

    Nutanix Platform Overview | 299



- vSRX Virtual Firewall Deployment with Nutanix Overview | 302
- Understand vSRX Virtual Firewall Deployment with Nutanix AHV | 304
- Sample vSRX Virtual Firewall Deployment Using Nutanix AHV | 306

#### Requirements for vSRX Virtual Firewall on Nutanix | 307

- System Requirements for Nutanix | 307
- Reference Requirements | 310

#### Install vSRX Virtual Firewall in Nutanix | 312

##### Launch and Deploy vSRX Virtual Firewall in Nutanix AHV Cluster | 312

- Log In to Nutanix Setup | 312
- Adding a vSRX Virtual Firewall Image | 314
- Network Creation | 314
- Create and Deploy a vSRX Virtual Firewall VM | 315
- Power on the vSRX Virtual Firewall VMs | 322
- Launch vSRX Virtual Firewall VM Console | 323

##### Upgrade the Junos OS for vSRX Virtual Firewall Software Release | 324

## 6

### vSRX Virtual Firewall Deployment for AWS

#### Overview | 326

##### Understand vSRX Virtual Firewall with AWS | 326

##### Requirements for vSRX Virtual Firewall on AWS | 332

#### Configure and Manage Virtual Firewall in AWS | 337

##### Configure an Amazon Virtual Private Cloud for vSRX Virtual Firewall | 337

- Step 1: Create an Amazon VPC and Internet Gateway | 338
- Step 2: Add Subnets for vSRX Virtual Firewall | 340
- Step 3: Attach an interface to a Subnet | 341
- Step 4: Add Route Tables for vSRX Virtual Firewall | 344
- Step 5: Add Security Groups for vSRX Virtual Firewall | 345

##### Launch a vSRX Virtual Firewall Instance on an Amazon Virtual Private Cloud | 348

- Step 1: Create an SSH Key Pair | 348
- Step 2: Launch a vSRX Virtual Firewall Instance | 350
- Step 3: View the AWS System Logs | 354
- Step 4: Add Network Interfaces for vSRX Virtual Firewall | 354
- Step 5: Allocate Elastic IP Addresses | 356

Step 6: Add the vSRX Virtual Firewall Private Interfaces to the Route Tables | **356**

Step 7: Reboot the vSRX Virtual Firewall Instance | **357**

Step 8: Log in to a vSRX Virtual Firewall Instance | **357**

Enroll a vSRX Virtual Firewall on AWS with Juniper ATP Cloud | **359**

Using Cloud-Init to Automate the Initialization of vSRX Virtual Firewall Instances in AWS | **364**

AWS Elastic Load Balancing and Elastic Network Adapter | **366**

Overview of AWS Elastic Load Balancing | **367**

Overview of Application Load Balancer | **369**

Deployment of AWS Application Load Balancer | **370**

Invoking Cloud Formation Template (CFT) Stack Creation for vSRX Virtual Firewall Behind AWS Application Load Balancer Deployment | **374**

Overview of AWS Elastic Network Adapter (ENA) for vSRX Virtual Firewall Instances | **383**

Multi-Core Scaling Support on AWS with SWRSS and ENA | **384**

Centralized Monitoring and Troubleshooting using AWS Features | **385**

Understanding Centralized Monitoring Using Cloudwatch | **385**

Integration of vSRX Virtual Firewall with AWS Monitoring and Troubleshooting Features | **393**

Grant Permission for vSRX Virtual Firewall to access AWS CloudWatch and Security Hub | **393**

Enable Monitoring of vSRX Virtual Firewall Instances with AWS CloudWatch Metric | **395**

Collect, Store, and View vSRX Virtual Firewall Logs to AWS CloudWatch | **396**

Enable and Configure Security Hub on vSRX Virtual Firewall | **397**

Deploying vSRX Virtual Firewall 3.0 for Securing Data using AWS KMS | **398**

Integrate AWS KMS with vSRX Virtual Firewall 3.0 | **398**

AWS Cloud Formation Templates | **402**

Configure vSRX Virtual Firewall Using the CLI | **406**

Understand vSRX Virtual Firewall on AWS Preconfiguration and Factory Defaults | **406**

Add a Basic vSRX Virtual Firewall Configuration | **407**

Add DNS Servers | **410**

Add vSRX Virtual Firewall Feature Licenses | **410**

Configure vSRX Virtual Firewall Using the J-Web Interface | **411**

Access the J-Web Interface and Configure vSRX Virtual Firewall | **411**

Apply the Configuration Settings for vSRX Virtual Firewall | **413**

Add vSRX Virtual Firewall Feature Licenses | **414**

Upgrade Junos OS Software on a vSRX Virtual Firewall Instance | 414

Upgrade the Junos OS for vSRX Virtual Firewall Software Release | 414

Replace the vSRX Virtual Firewall Instance on AWS | 415

Remove a vSRX Virtual Firewall Instance on AWS | 416

Geneve Flow Infrastructure on vSRX Virtual Firewall 3.0 | 416

Overview | 417

Enable Security Policies for Geneve Packet Flow Tunnel Inspection | 418

Requirements | 419

Overview | 419

Configuration (vSRX Virtual Firewall 3.0 as Tunnel Endpoint) | 419

Configuration (vSRX Virtual Firewall 3.0 as Transit Router) | 426

AWS Gateway Load Balancing with Geneve | 433

Overview of AWS Gateway Load Balancer | 433

AWS GWLB with Geneve vSRX Virtual Firewall 3.0 Deployment | 435

**Virtual Firewall in AWS Use Cases | 437**

Example: Configuring NAT for vSRX Virtual Firewall | 437

Before You Begin | 437

Overview | 437

Configuration | 438

Configuring NAT | 438

Example: Configure VPN on vSRX Virtual Firewall Between Amazon VPCs | 439

Before You Begin | 440

Overview | 440

vSRX1 VPN Configuration | 440

Verification | 444

Example: Configure Juniper ATP Cloud for vSRX Virtual Firewall | 445

Before You Begin | 445

Overview | 445

Juniper ATP Cloud Configuration | 445

## **vSRX Virtual Firewall Deployment for Microsoft Azure**

**Overview | 449**

Understand vSRX Virtual Firewall with Microsoft Azure Cloud | 449

Requirements for vSRX Virtual Firewall on Microsoft Azure | 453

## **Deploy vSRX Virtual Firewall from the Azure Portal | 461**

Before You Deploy vSRX Virtual Firewall from the Azure Portal | 461

Create a Resource Group | 462

Create a Storage Account | 466

Create a Virtual Network | 471

Deploy the vSRX Virtual Firewall Image from Azure Marketplace | 476

Deploy the vSRX Virtual Firewall Image | 476

Verify Deployment of vSRX Virtual Firewall to Microsoft Azure | 489

Log In to a vSRX Virtual Firewall VM | 490

## **Deploy vSRX Virtual Firewall from the Azure CLI | 493**

Before You Deploy vSRX Virtual Firewall Using the Azure CLI | 493

Deploy vSRX Virtual Firewall from the Azure CLI | 495

Install the Microsoft Azure CLI | 496

Download the vSRX Virtual Firewall Deployment Tools | 497

Change Parameter Values in the vSRX Virtual Firewall.parameter.json File | 498

Deploy the vSRX Virtual Firewall Using the Shell Script | 502

Verify Deployment of vSRX Virtual Firewall to Microsoft Azure | 504

Log In to a vSRX Virtual Firewall Instance | 507

## **Configure and Manage vSRX Virtual Firewall for Microsoft Azure | 509**

Configure vSRX Virtual Firewall Using the CLI | 509

Configure vSRX Virtual Firewall Using the J-Web Interface | 511

Access the J-Web Interface and Configuring vSRX Virtual Firewall | 512

Apply the Configuration | 514

Add vSRX Virtual Firewall Feature Licenses | 515

Remove a vSRX Virtual Firewall Instance from Microsoft Azure | 515

Upgrade Junos OS Software on a vSRX Virtual Firewall Instance | 515

Upgrade the Junos OS for vSRX Virtual Firewall Software Release | 516

Replace the vSRX Virtual Firewall Instance on Azure | 516

## **Configure Azure Features on vSRX Virtual Firewall and Use Cases | 518**

## Deployment of Microsoft Azure Hardware Security Module on vSRX Virtual Firewall 3.0 | 518

- Microsoft Azure Key Vault Hardware Security Module Integration Overview | 519
- Configure Microsoft Azure Key Vault HSM on vSRX Virtual Firewall 3.0 | 520
- Change the Master Encryption Password | 524
- Verify the Status of the HSM | 524
- request security hsm master-encryption-password | 525
- show security hsm status | 526
- Understanding VPN Functionality with Microsoft Azure Key Vault HSM Service | 529
- CLI Behavior With and Without HSM | 533
- request security pki local-certificate enroll scep | 534

## Example: Configure an IPsec VPN Between Two vSRX Virtual Firewall Instances | 538

- Before You Begin | 538
- Overview | 538
- vSRX Virtual Firewall IPsec VPN Configuration | 539
- Verification | 542

## Example: Configure an IPsec VPN Between a vSRX Virtual Firewall and Virtual Network Gateway in Microsoft Azure | 543

- Before You Begin | 544
- Overview | 544
- vSRX Virtual Firewall IPsec VPN Configuration | 544
- Microsoft Azure Virtual Network Gateway Configuration | 546

## Example: Configure Juniper ATP Cloud for vSRX Virtual Firewall | 548

- Before You Begin | 548
- Overview | 548
- Juniper ATP Cloud Configuration | 548

# 8

## vSRX Virtual Firewall Deployment for Google Cloud Platform

### Overview | 552

#### Understand vSRX Virtual Firewall Deployment with Google Cloud | 552

- Understand vSRX Virtual Firewall Deployment with Google Cloud Platform | 552

#### Requirements for vSRX Virtual Firewall on Google Cloud Platform | 555

- Google Compute Engine Instance Types | 555
- vSRX Virtual Firewall Support for Google Cloud | 556
- vSRX Virtual Firewall Specifications for GCP | 557

## Install vSRX Virtual Firewall in Google Cloud | 560

Prepare to setup vSRX Virtual Firewall Deployment on GCP | 560

- Step 1: Google Cloud Platform Account Planning | 562
- Step 2: Define Network Attributes and Generate SSH Key Pair for Authentication | 563
- Step 3: Plan Google Virtual Private Cloud (VPC) Network | 565

Deploy vSRX Virtual Firewall in Google Cloud Platform | 566

- Deploy the vSRX Virtual Firewall Firewall from Marketplace Launcher | 566
- Deploy the vSRX Virtual Firewall Instance from GCP Portal Using Custom Private Image | 574
  - Upload vSRX Virtual Firewall Image to Google Cloud Storage | 574
  - Create vSRX Virtual Firewall Image | 576
  - Deploy the vSRX Virtual Firewall Firewall from GCP Portal | 578
- Deploy the vSRX Virtual Firewall Firewall Using Cloud-init | 580

Upgrade the Junos OS for vSRX Virtual Firewall Software Release | 583

Secure Data with vSRX Virtual Firewall 3.0 Using GCP KMS (HSM) | 584

- Overview | 584
- Integrate GCP KMS with vSRX Virtual Firewall 3.0 | 586
- Verify the Status of the HSM | 589
- show security hsm status | 590
  - | 592
- request security hsm master-encryption-password | 592

9

## vSRX Virtual Firewall Deployment for IBM Cloud

Overview | 595

vSRX Virtual Firewall Overview | 595

Getting Started with Juniper vSRX Virtual Firewall on IBM Cloud | 598

- Overview of vSRX Virtual Firewall in IBM Cloud | 598
- Choosing a vSRX Virtual Firewall license | 600
- Ordering a vSRX Virtual Firewall | 602

Junos OS Features Supported on vSRX Virtual Firewall | 604

Installing and Configuring vSRX Virtual Firewall in IBM | 618

Performing vSRX Virtual Firewall Basics in IBM Cloud | 618

- Viewing all gateway appliances | 619

- Viewing gateway appliance details | 619
- Renaming a gateway appliance | 619
- Canceling a gateway appliance | 620
- Performing additional vSRX Virtual Firewall tasks | 620

#### vSRX Virtual Firewall Readiness Checks in IBM Cloud | 623

- Checking vSRX Virtual Firewall readiness | 623
- Readiness status | 624
- Correcting readiness errors | 624

#### Managing VLANs with a gateway appliance | 626

- Associating a VLAN to a gateway appliance | 626
- Routing an associated VLAN | 626
- Bypassing gateway appliance routing for a VLAN | 627
- Disassociating a VLAN from a gateway appliance | 627

#### Working with the vSRX Virtual Firewall Default Configurations | 628

- Understanding the vSRX Virtual Firewall default configuration | 628
- Importing and Exporting a vSRX Virtual Firewall Configuration | 629
- Exporting part of the vSRX Virtual Firewall configuration | 630
- Importing the entire vSRX Virtual Firewall configuration | 631
- Importing part of the vSRX Virtual Firewall configuration | 631

#### Migrating Legacy Configurations to the Current vSRX Virtual Firewall Architecture | 633

- Migrating 1G vSRX Virtual Firewall Standalone Configurations | 633
- Migrating 1G vSRX Virtual Firewall High Availability configurations | 641

#### Allowing SSH and Ping to a Public Subnet | 642

- Allowing SSH and Ping to a Public Subnet | 642

#### Performing vSRX Virtual Firewall Advanced Tasks in IBM Cloud | 643

- Working with Firewalls | 643
- Zone Policies | 644
- Firewall Filters | 645
- Working with sNAT | 645
- Working with Failover | 645
- Working with Routing | 647
- Working with VPN | 648

- Securing the Host Operating System | 654
- Configuring the Management Interfaces | 656

#### Upgrading the vSRX Virtual Firewall in IBM Cloud | 657

- Upgrading | 657
- General Upgrade Considerations | 660
- Upgrading using OS Reload | 663
- Rollback Options | 664
- Unsupported Upgrades | 664

#### Managing vSRX Virtual Firewall in IBM Cloud | 666

vSRX Virtual Firewall Configuration and Management Tools | 666

Managing Security Policies for Virtual Machines Using Junos Space Security Director | 667

#### Monitoring and Troubleshooting | 669

Technical Support | 669

10

### vSRX Virtual Firewall Deployment for OCI

#### Overview | 671

Understanding vSRX Virtual Firewall Deployment in Oracle Cloud Infrastructure | 671

- Overview of Oracle VM Architecture | 671
- vSRX Virtual Firewall with Oracle Cloud Infrastructure | 672
- OCI Glossary | 672

Requirements for vSRX Virtual Firewall on Oracle Cloud Infrastructure | 673

- Minimum System Requirements for OCI | 674
- vSRX Virtual Firewall Default Settings with OCI | 675
- Best Practices for Deploying vSRX Virtual Firewall | 675

#### Installing vSRX Virtual Firewall in OCI | 676

vSRX Virtual Firewall Deployment in Oracle Cloud Infrastructure | 676

- Overview | 676
- Launch vSRX Virtual Firewall Instances in the OCI | 678

Upgrade the Junos OS for vSRX Virtual Firewall Software Release | 692

#### vSRX Virtual Firewall Licensing | 693

Licenses for vSRX Virtual Firewall | 693



# About This Guide

vSRX Virtual Firewall is the virtualized form of the Juniper Networks next-generation firewall. It is positioned for use in a virtualized or cloud environment where it can protect and secure east-west and north-south traffic. This guide provides you details on deployment of vSRX Virtual Firewall on various private and public cloud platforms.

# 1

PART

## vSRX Virtual Firewall Deployment for KVM

---

[Overview | 2](#)

[Install vSRX Virtual Firewall in KVM | 19](#)

[vSRX Virtual Firewall VM Management with KVM | 62](#)

[Configure vSRX Virtual Firewall Chassis Clusters on KVM | 89](#)

---

# Overview

## IN THIS CHAPTER

- Understand vSRX Virtual Firewall with KVM | 2
- Requirements for vSRX Virtual Firewall on KVM | 7

## Understand vSRX Virtual Firewall with KVM

### IN THIS SECTION

- vSRX Virtual Firewall on KVM | 2
- vSRX Virtual Firewall Scale Up Performance | 3

This section presents an overview of vSRX Virtual Firewall on KVM.

### vSRX Virtual Firewall on KVM

The Linux kernel uses the kernel-based virtual machine (*KVM*) as a virtualization infrastructure. KVM is open source software that you can use to create multiple virtual machines (VMs) and to install security and networking appliances.

The basic components of KVM include:

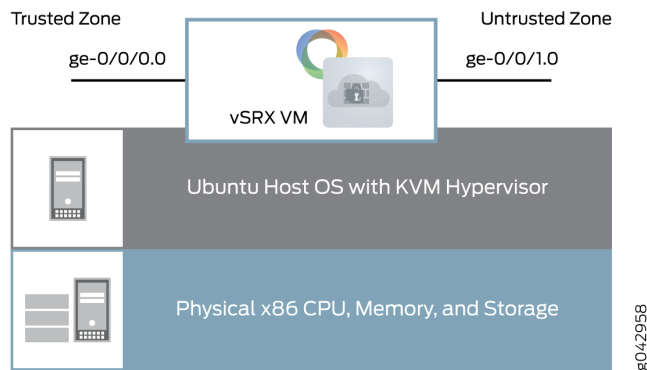
- A loadable kernel module included in the Linux kernel that provides the basic virtualization infrastructure
- A processor-specific module

When loaded into the Linux kernel, the KVM software acts as a *hypervisor*. KVM supports *multitenancy* and allows you to run multiple vSRX Virtual Firewall VMs on the *host* OS. KVM manages and shares the system resources between the host OS and the multiple vSRX Virtual Firewall VMs.

**NOTE:** vSRX Virtual Firewall requires you to enable hardware-based virtualization on a host OS that contains an Intel Virtualization Technology (VT) capable processor.

Figure 1 on page 3 illustrates the basic structure of a vSRX Virtual Firewall VM on an Ubuntu server.

**Figure 1: vSRX Virtual Firewall VM on Ubuntu**



## vSRX Virtual Firewall Scale Up Performance

Table 1 on page 3 shows the vSRX Virtual Firewall scale up performance when deployed on KVM, based on the number of vCPUs and vRAM applied to a vSRX Virtual Firewall VM along with the Junos OS release in which a particular vSRX Virtual Firewall software specification was introduced.

**Table 1: vSRX Virtual Firewall Scale Up Performance**

vCPUs	vRAM	NICs	Release Introduced
2 vCPUs	4 GB	<ul style="list-style-type: none"> <li>Virtio</li> <li>SR-IOV (Intel 82599, X520/540)</li> </ul>	Junos OS Release 15.1X49-D15 and Junos OS Release 17.3R1

**Table 1: vSRX Virtual Firewall Scale Up Performance (Continued)**

vCPUs	vRAM	NICs	Release Introduced
5 vCPUs	8 GB	<ul style="list-style-type: none"> <li>• Virtio</li> <li>• SR-IOV (Intel 82599, X520/540)</li> </ul>	Junos OS Release 15.1X49-D70 and Junos OS Release 17.3R1
5 vCPUs	8 GB	<ul style="list-style-type: none"> <li>• SR-IOV (Intel X710/ XL710)</li> </ul>	Junos OS Release 15.1X49-D90 and Junos OS Release 17.3R1
1 vCPU	4 GB	SR-IOV on the Mellanox ConnectX-4 and ConnectX-5 family adapters.	Junos OS Release 21.2R1
4 vCPUs	8 GB	SR-IOV on the Mellanox ConnectX-4 and ConnectX-5 family adapters.	Junos OS Release 21.2R1
8 vCPUs	16GB	SR-IOV on the Mellanox ConnectX-4 and ConnectX-5 family adapters.	Junos OS Release 21.2R1
16 vCPUs	32 GB	SR-IOV on the Mellanox ConnectX-4 and ConnectX-5 family adapters.	Junos OS Release 21.2R1

You can scale the performance and capacity of a vSRX Virtual Firewall instance by increasing the number of vCPUs and the amount of vRAM allocated to the vSRX Virtual Firewall. The multi-core vSRX Virtual Firewall automatically selects the appropriate vCPUs and vRAM values at boot time, as well as the number of Receive Side Scaling (RSS) queues in the NIC. If the vCPU and vRAM settings allocated to a vSRX Virtual Firewall VM do not match what is currently available, the vSRX Virtual Firewall scales down to the closest supported value for the instance. For example, if a vSRX Virtual Firewall VM has 3 vCPUs and 8 GB of vRAM, vSRX Virtual Firewall boots to the smaller vCPU size, which requires a minimum of 2 vCPUs. You can scale up a vSRX Virtual Firewall instance to a higher number of vCPUs

and amount of vRAM, but you cannot scale down an existing vSRX Virtual Firewall instance to a smaller setting.

**NOTE:** The number of RSS queues typically matches with the number of data plane vCPUs of a vSRX Virtual Firewall instance. For example, a vSRX Virtual Firewall with 4 data plane vCPUs should have 4 RSS queues.

## vSRX Virtual Firewall Session Capacity Increase

vSRX Virtual Firewall solution is optimized to increase the session numbers by increasing the memory.

With the ability to increase the session numbers by increasing the memory, you can enable vSRX Virtual Firewall to:

- Provide highly scalable, flexible and high-performance security at strategic locations in the mobile network.
- Deliver the performance that service providers require to scale and protect their networks.

Run the `show security flow session summary | grep maximum` command to view the maximum number of sessions.

Starting in Junos OS Release 18.4R1, the number of flow sessions supported on a vSRX Virtual Firewall instance is increased based on the vRAM size used.

Starting in Junos OS Release 19.2R1, the number of flow sessions supported on a vSRX Virtual Firewall 3.0 instance is increased based on the vRAM size used.

**NOTE:** Maximum of 28M sessions are supported on vSRX Virtual Firewall 3.0. You can deploy vSRX Virtual Firewall 3.0 with more than 64G memory, but the maximum flow sessions can still be only 28M.

[Table 2 on page 5](#) lists the flow session capacity.

**Table 2: vSRX Virtual Firewall and vSRX Virtual Firewall 3.0 Flow Session Capacity Details**

vCPUs	Memory	Flow Session Capacity
2	4 GB	0.5 M

**Table 2: vSRX Virtual Firewall and vSRX Virtual Firewall 3.0 Flow Session Capacity Details (Continued)**

vCPUs	Memory	Flow Session Capacity
2	6 GB	1 M
2/5	8 GB	2 M
2/5	10 GB	2 M
2/5	12 GB	2.5 M
2/5	14 GB	3 M
2/5/9	16 GB	4 M
2/5/9	20 GB	6 M
2/5/9	24 GB	8 M
2/5/9	28 GB	10 M
2/5/9/17	32 GB	12 M
2/5/9/17	40 GB	16 M
2/5/9/17	48 GB	20 M
2/5/9/17	56 GB	24 M
2/5/9/17	64 GB	28 M

## Release History Table

Release	Description
19.2R1	Starting in Junos OS Release 19.2R1, the number of flow sessions supported on a vSRX Virtual Firewall 3.0 instance is increased based on the vRAM size used.
18.4R1	Starting in Junos OS Release 18.4R1, the number of flow sessions supported on a vSRX Virtual Firewall instance is increased based on the vRAM size used.

## RELATED DOCUMENTATION

[Requirements for vSRX Virtual Firewall on KVM | 7](#)

[Upgrade a Multi-core vSRX Virtual Firewall | 78](#)

[Install vSRX Virtual Firewall with KVM | 21](#)

## Requirements for vSRX Virtual Firewall on KVM

### IN THIS SECTION

- [Software Specifications | 7](#)
- [Hardware Specifications | 13](#)
- [Best Practices for Improving vSRX Virtual Firewall Performance | 14](#)
- [Interface Mapping for vSRX Virtual Firewall on KVM | 16](#)
- [vSRX Virtual Firewall Default Settings on KVM | 18](#)

This section presents an overview of requirements for deploying a vSRX Virtual Firewall instance on KVM;

### Software Specifications

No Link Title lists the system software requirement specifications when deploying vSRX Virtual Firewall in a KVM environment. The table outlines the Junos OS release in which a particular software specification for deploying vSRX Virtual Firewall on KVM was introduced. You will need to download a specific Junos OS release to take advantage of certain features.





**CAUTION:** A Page Modification Logging (PML) issue related to the KVM host kernel might prevent the vSRX Virtual Firewall from successfully booting. If you experience this behavior with the vSRX Virtual Firewall, we recommend that you disable the PML at the host kernel level. See *Prepare Your Server for vSRX Installation* for details about disabling the PML as part of enabling nested virtualization.

**Table 3: Feature Support on vSRX Virtual Firewall**

Features	Specification	Junos OS Release Introduced
vCPUs/Memory	2 vCPU / 4 GB RAM	Junos OS Release 15.1X49-D15 and Junos OS Release 17.3R1 (vSRX Virtual Firewall)
	5 vCPU / 8 GB RAM	Junos OS Release 15.1X49-D70 and Junos OS Release 17.3R1 (vSRX Virtual Firewall)
	9 vCPU / 16 GB RAM	Junos OS Release 18.4R1 (vSRX Virtual Firewall) Junos OS Release 19.1R1 (vSRX Virtual Firewall 3.0)
	17 vCPU / 32 GB RAM	Junos OS Release 18.4R1 (vSRX Virtual Firewall) Junos OS Release 19.1R1 (vSRX Virtual Firewall 3.0)
Flexible flow session capacity scaling by an additional vRAM	NA	Junos OS Release 19.1R1 (vSRX Virtual Firewall) Junos OS Release 19.2R1 (vSRX Virtual Firewall 3.0)
Multicore scaling support (Software RSS)	NA	Junos OS Release 19.3R1 (vSRX Virtual Firewall 3.0 only)

**Table 3: Feature Support on vSRX Virtual Firewall (Continued)**

Features	Specification	Junos OS Release Introduced
Reserve additional vCPU cores for the Routing Engine (vSRX Virtual Firewall and vSRX Virtual Firewall 3.0)	NA	
Virtio (virtio-net, vhost-net) (vSRX Virtual Firewall and vSRX Virtual Firewall 3.0)	NA	
<b>Supported Hypervisors</b>		
Linux KVM Hypervisor support	Ubuntu 14.04.5, 16.04, and 16.10	Junos OS Release 18.4R1
	Ubuntu 18.04 and 20.04	Junos OS Release 20.4R1
	Red Hat Enterprise Linux (RHEL) 7.3	Junos OS Release 18.4R1
	Red Hat Enterprise Linux (RHEL) 7.6 and 7.7	Junos OS Release 19.2R1
	Red Hat Enterprise Linux (RHEL) 8.2	Junos OS Release 20.4R1
	CentOS 7.1, 7.2, 7.6, and 7.7	Junos OS Release 19.2R1
<b>Other Features</b>		
Cloud-init	NA	
Powermode IPSec (PMI)	NA	
Chassis cluster	NA	

**Table 3: Feature Support on vSRX Virtual Firewall (Continued)**

Features	Specification	Junos OS Release Introduced
GTP TEID based session distribution using Software RSS	NA	Yes (Junos OS Release 19.3R1 onwards)
On-device antivirus scan engine (Avira)	NA	Yes (Junos OS Release 19.4R1 onwards)
LLDP	NA	Yes (Junos OS Release 21.1R1 onwards)
Junos Telemetry Interface	NA	Yes (Junos OS Release 20.3R1 onwards)
<b>System Requirements</b>		
Hardware acceleration/enabled VMX CPU flag in the hypervisor	NA	
Disk space	16 GB (IDE or SCSI drives) (vSRX Virtual Firewall)	Junos OS Release 15.1X49-D15 and Junos OS Release 17.3R1
	18 GB (vSRX Virtual Firewall 3.0)	

**Table 4: vNIC Support on vSRX Virtual Firewall**

vNICs	Release Introduced
Virtio SA and HA	
SR-IOV SA and HA over Intel 82599/X520 series	Junos OS Release 15.1X49-D90 and Junos OS Release 17.3R1
SR-IOV SA and HA over Intel X710/XL710/XXV710 series	Junos OS Release 15.1X49-D90
SR-IOV SA over Intel E810 series	Junos OS Release 18.1R1

Table 4: vNIC Support on vSRX Virtual Firewall (Continued)

vNICs	Release Introduced
SR-IOV HA over Intel E810 series	unos OS Release 18.1R1
SR-IOV SA and HA over Mellanox ConnectX-3	Not supported
SR-IOV SA and HA over Mellanox ConnectX-4/5/6 (MLX5 driver only)	Junos OS Release 18.1R1 (vSRX Virtual Firewall) Junos OS Release 21.2R1 onwards on vSRX Virtual Firewall 3.0
PCI passthrough over Intel 82599/X520 series	Not supported
PCI passthrough over Intel X710/XL710 series	Not supported
Data Plane Development Kit (DPDK) version 17.05	Junos OS Release 18.2R1
Data Plane Development Kit (DPDK) version 18.11 Starting in Junos OS Release 19.4R1, DPDK version 18.11 is supported on vSRX Virtual Firewall. With this feature the Mellanox Connect Network Interface Card (NIC) on vSRX Virtual Firewall now supports OSPF Multicast and VLANs.	Junos OS Release 19.4R1
Data Plane Development Kit (DPDK) version 20.11 Starting in Junos OS Release 21.2R1, we've upgraded the Data Plane Development Kit (DPDK) from version 18.11 to version 20.11. The new version supports ICE Poll Mode Driver (PMD), which enables the physical Intel E810 series 100G NIC support on vSRX Virtual Firewall 3.0.	Junos OS Release 21.2R1

**NOTE:** A vSRX Virtual Firewall on KVM deployment requires you to enable hardware-based virtualization on a host OS that contains an Intel Virtualization Technology (VT) capable processor. You can verify CPU compatibility here: [http://www.linux-kvm.org/page/Processor\\_support](http://www.linux-kvm.org/page/Processor_support)

No Link Title lists the specifications on the vSRX Virtual Firewall VM.

Starting in Junos OS Release 19.1R1, the vSRX Virtual Firewall instance supports guest OS using 9 or 17 vCPUs with single-root I/O virtualization over Intel X710/XL710 on Linux KVM hypervisor for improved scalability and performance.

## KVM Kernel Recommendations for vSRX Virtual Firewall

[Table 5 on page 12](#) lists the recommended Linux kernel version for your Linux host OS when deploying vSRX Virtual Firewall on KVM. The table outlines the Junos OS release in which support for a particular Linux kernel version was introduced.

**Table 5: Kernel Recommendations for KVM**

Linux Distribution	Linux Kernel Version	Supported Junos OS Release
CentOS	3.10.0.229 Upgrade the Linux kernel to capture the recommended version.	Junos OS Release 15.1X49-D15 and Junos OS Release 17.3R1 or later release
Ubuntu	3.16	Junos OS Release 15.1X49-D15 and Junos OS Release 17.3R1 or later release
	4.4	Junos OS Release 15.1X49-D15 and Junos OS Release 17.3R1 or later release
	18.04	Junos OS Release 20.4R1 or later release
	20.04	Junos OS Release 20.4R1 or later release
RHEL	3.10	Junos OS Release 15.1X49-D15 and Junos OS Release 17.3R1 or later release

## Additional Linux Packages for vSRX Virtual Firewall on KVM

[Table 6 on page 13](#) lists the additional packages you need on your Linux host OS to run vSRX Virtual Firewall on KVM. See your host OS documentation for how to install these packages if they are not present on your server.

**Table 6: Additional Linux Packages for KVM**

Package	Version	Download Link
libvirt	0.10.0	<a href="#">libvirt download</a>
virt-manager (Recommended)	0.10.0	<a href="#">virt-manager download</a>

## Hardware Specifications

[Table 7 on page 13](#) lists the hardware specifications for the host machine that runs the vSRX Virtual Firewall VM.

**Table 7: Hardware Specifications for the Host Machine**

Component	Specification
Host processor type	Intel x86_64 multi-core CPU  <b>NOTE:</b> DPDK requires Intel Virtualization VT-x/VT-d support in the CPU. See <a href="#">About Intel Virtualization Technology</a> .

Table 7: Hardware Specifications for the Host Machine (*Continued*)

Component	Specification
Physical NIC support for vSRX Virtual Firewall and vSRX Virtual Firewall 3.0	<ul style="list-style-type: none"> <li>• Virtio</li> <li>• SR-IOV (Intel X710/XL710, X520/540, 82599)</li> <li>• SR-IOV (Mellanox ConnectX-3/ConnectX-3 Pro and Mellanox ConnectX-4 EN/ConnectX-4 Lx EN)</li> </ul> <p><b>NOTE:</b> If using SR-IOV with either the Mellanox ConnectX-3 or ConnectX-4 Family Adapters, on the Linux host, if necessary, install the latest MLNX_OFED Linux driver. See <a href="#">Mellanox OpenFabrics Enterprise Distribution for Linux (MLNX_OFED)</a>.</p> <p><b>NOTE:</b> You must enable the Intel VT-d extensions to provide hardware support for directly assigning physical devices per guest. See <i>Configure SR-IOV and PCI on KVM</i>.</p>
Physical NIC support for vSRX Virtual Firewall 3.0	Support SR-IOV on Intel X710/XL710/XXV710, and Intel E810.

## Best Practices for Improving vSRX Virtual Firewall Performance

Review the following practices to improve vSRX Virtual Firewall performance.

### NUMA Nodes

The x86 server architecture consists of multiple sockets and multiple cores within a socket. Each socket has memory that is used to store packets during I/O transfers from the NIC to the host. To efficiently read packets from memory, guest applications and associated peripherals (such as the NIC) should reside within a single socket. A penalty is associated with spanning CPU sockets for memory accesses, which might result in nondeterministic performance. For vSRX Virtual Firewall, we recommend that all vCPUs for the vSRX Virtual Firewall VM are in the same physical non-uniform memory access (NUMA) node for optimal performance.



**CAUTION:** The Packet Forwarding Engine (PFE) on the vSRX Virtual Firewall will become unresponsive if the NUMA nodes topology is configured in the hypervisor to spread the instance's vCPUs across multiple host NUMA nodes. vSRX Virtual Firewall requires that you ensure that all vCPUs reside on the same NUMA node.

We recommend that you bind the vSRX Virtual Firewall instance with a specific NUMA node by setting NUMA node affinity. NUMA node affinity constrains the vSRX Virtual Firewall VM resource scheduling to only the specified NUMA node.

## Mapping Virtual Interfaces to a vSRX Virtual Firewall VM

To determine which virtual interfaces on your Linux host OS map to a vSRX Virtual Firewall VM:

1. Use the `virsh list` command on your Linux host OS to list the running VMs.

```
hostOS# virsh list
```

Id	Name	State
9	centos1	running
15	centos2	running
16	centos3	running
48	vsrx	running
50	1117-2	running
51	1117-3	running

2. Use the `virsh domiflist vsrx-name` command to list the virtual interfaces on that vSRX Virtual Firewall VM.

```
hostOS# virsh domiflist vsrx
```

Interface	Type	Source	Model	MAC
vnet1	bridge	brem2	virtio	52:54:00:8f:75:a5
vnet2	bridge	br1	virtio	52:54:00:12:37:62
vnet3	bridge	brconnect	virtio	52:54:00:b2:cd:f4

**NOTE:** The first virtual interface maps to the `fxp0` interface in Junos OS.



## Interface Mapping for vSRX Virtual Firewall on KVM

Each network adapter defined for a vSRX Virtual Firewall is mapped to a specific interface, depending on whether the vSRX Virtual Firewall instance is a standalone VM or one of a cluster pair for high availability. The interface names and mappings in vSRX Virtual Firewall are shown in [Table 8 on page 16](#) and [Table 9 on page 17](#).

Note the following:

- In standalone mode:
  - fxp0 is the out-of-band management interface.
  - ge-0/0/0 is the first traffic (revenue) interface.
- In cluster mode:
  - fxp0 is the out-of-band management interface.
  - em0 is the cluster control link for both nodes.
  - Any of the traffic interfaces can be specified as the fabric links, such as ge-0/0/0 for fab0 on node 0 and ge-7/0/0 for fab1 on node 1.

[Table 8 on page 16](#) shows the interface names and mappings for a standalone vSRX Virtual Firewall VM.

**Table 8: Interface Names for a Standalone vSRX Virtual Firewall VM**

Network Adapter	Interface Name in Junos OS for vSRX Virtual Firewall
1	fxp0
2	ge-0/0/0
3	ge-0/0/1
4	ge-0/0/2
5	ge-0/0/3

**Table 8: Interface Names for a Standalone vSRX Virtual Firewall VM (Continued)**

Network Adapter	Interface Name in Junos OS for vSRX Virtual Firewall
6	ge-0/0/4
7	ge-0/0/5
8	ge-0/0/6

[Table 9 on page 17](#) shows the interface names and mappings for a pair of vSRX Virtual Firewall VMs in a cluster (node 0 and node 1).

**Table 9: Interface Names for a vSRX Virtual Firewall Cluster Pair**

Network Adapter	Interface Name in Junos OS for vSRX Virtual Firewall
1	fxp0 (node 0 and 1)
2	em0 (node 0 and 1)
3	ge-0/0/0 (node 0) ge-7/0/0 (node 1)
4	ge-0/0/1 (node 0) ge-7/0/1 (node 1)
5	ge-0/0/2 (node 0) ge-7/0/2 (node 1)
6	ge-0/0/3 (node 0) ge-7/0/3 (node 1)
7	ge-0/0/4 (node 0) ge-7/0/4 (node 1)

**Table 9: Interface Names for a vSRX Virtual Firewall Cluster Pair (Continued)**

Network Adapter	Interface Name in Junos OS for vSRX Virtual Firewall
8	ge-0/0/5 (node 0) ge-7/0/5 (node 1)

## vSRX Virtual Firewall Default Settings on KVM

vSRX Virtual Firewall requires the following basic configuration settings:

- Interfaces must be assigned IP addresses.
- Interfaces must be bound to zones.
- Policies must be configured between zones to permit or deny traffic.

[Table 10 on page 18](#) lists the factory-default settings for security policies on the vSRX Virtual Firewall.

**Table 10: Factory Default Settings for Security Policies**

Source Zone	Destination Zone	Policy Action
trust	untrust	permit
trust	trust	permit
untrust	trust	deny

## RELATED DOCUMENTATION

[About Intel Virtualization Technology](#)

[DPDK Release Notes](#)

# Install vSRX Virtual Firewall in KVM

## IN THIS CHAPTER

- [Prepare Your Server for vSRX Virtual Firewall Installation | 19](#)
- [Install vSRX Virtual Firewall with KVM | 21](#)
- [Example: Install and Launch vSRX Virtual Firewall on Ubuntu | 27](#)
- [Load an Initial Configuration on a vSRX Virtual Firewall with KVM | 45](#)
- [Use Cloud-Init in an OpenStack Environment to Automate the Initialization of vSRX Virtual Firewall Instances | 48](#)

## Prepare Your Server for vSRX Virtual Firewall Installation

### IN THIS SECTION

- [Enable Nested Virtualization | 19](#)
- [Upgrade the Linux Kernel on Ubuntu | 21](#)

### Enable Nested Virtualization

We recommend that you enable nested *virtualization* on your host OS or OpenStack compute node. Nested virtualization is enabled by default on Ubuntu but is disabled by default on *CentOS*.

Use the following command to determine if nested virtualization is enabled on your host OS. The result should be Y.

```
hostOS# cat /sys/module/kvm_intel/parameters/nested
```

```
hostOS# Y
```

**NOTE:** APIC virtualization (APICv) does not work well with nested VMs such as those used with KVM. On Intel CPUs that support APICv (typically v2 models, for example E5 v2 and E7 v2), you must disable APICv on the host server before deploying vSRX Virtual Firewall.

To enable nested virtualization on the host OS:

1. Depending on your host operating system, perform the following:

- On CentOS, open the `/etc/modprobe.d/dist.conf` file in your default editor.

```
hostOS# vi /etc/modprobe.d/dist.conf
```

- On Ubuntu, open the `/etc/modprobe.d/qemu-system-x86.conf` file in your default editor.

```
hostOS# vi /etc/modprobe.d/qemu-system-x86.conf
```

2. Add the following line to the file:

```
hostOS# options kvm-intel nested=y enable_apicv=n
```

**NOTE:** A Page Modification Logging (PML) issue related to the KVM host kernel might prevent the vSRX Virtual Firewall from successfully booting. We recommend that you add the following line to the file *instead* of the line listed above in Step 2:

```
hostOS# options kvm-intel nested=y enable_apicv=n pml=n
```

3. Save the file and reboot the host OS.

4. (Optional) After the reboot, verify that nested virtualization is enabled.

```
hostOS# cat /sys/module/kvm_intel/parameters/nested
```

```
hostOS# Y
```

5. On Intel CPUs that support APICv ( for example, E5 v2 and E7 v2), disable APICv on the host OS.

```
root@host# sudo rmmmod kvm-intel
root@host# sudo sh -c "echo 'options kvm-intel enable_apicv=n' >> /etc/modprobe.d/dist.conf"
root@host# sudo modprobe kvm-intel
```

6. Optionally, verify that APICv is now disabled.

```
root@host# cat /sys/module/kvm_intel/parameters/enable_apicv
```

```
N
```

## Upgrade the Linux Kernel on Ubuntu

To upgrade to the latest stable Linux kernel on Ubuntu:

1. Get and install the available updated kernel.

```
hostOS:$ sudo apt-get install linux-image-generic-lts-utopic
```

2. Reboot the host OS.

```
hostOS:$ reboot
```

3. Optionally, type **uname -a** in a terminal on your host OS to verify that the host OS is using the latest kernel version.

```
hostOS:$ uname -a
```

```
3.16.0-48-generic
```

## Install vSRX Virtual Firewall with KVM

### IN THIS SECTION

- [Install vSRX Virtual Firewall with virt-manager | 22](#)
- [Install vSRX Virtual Firewall with virt-install | 24](#)

You use `virt-manager` or `virt-install` to install vSRX Virtual Firewall VMs. See your *host OS* documentation for complete details on these packages.

**NOTE:** To upgrade an existing vSRX Virtual Firewall instance, see *Migration, Upgrade, and Downgrade* in the *vSRX Virtual Firewall Release Notes*.

## Install vSRX Virtual Firewall with virt-manager

Ensure that sure you have already installed KVM, `qemu`, `virt-manager`, and `libvirt` on your host OS. You must also configure the required virtual networks and storage pool in the host OS for the vSRX Virtual Firewall VM. See your host OS documentation for details.

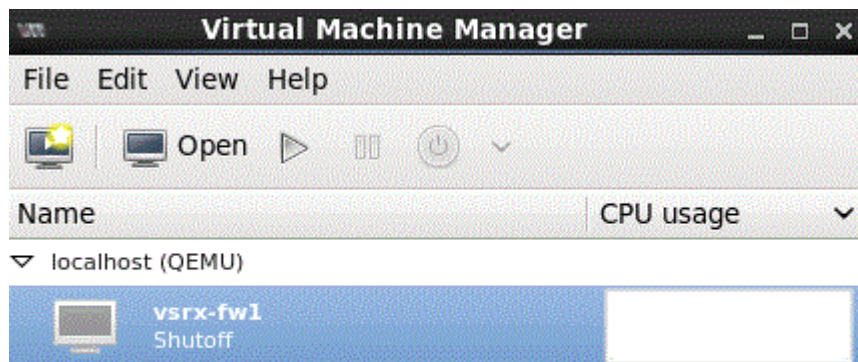
You can install and launch vSRX Virtual Firewall with the *KVM* `virt-manager` GUI package.

To install vSRX Virtual Firewall with `virt-manager`:

1. Download the vSRX Virtual Firewall QCOW2 image from the Juniper software download site.
2. On your host OS, type `virt-manager`. The Virtual Machine Manager appears. See [Figure 2 on page 22](#).

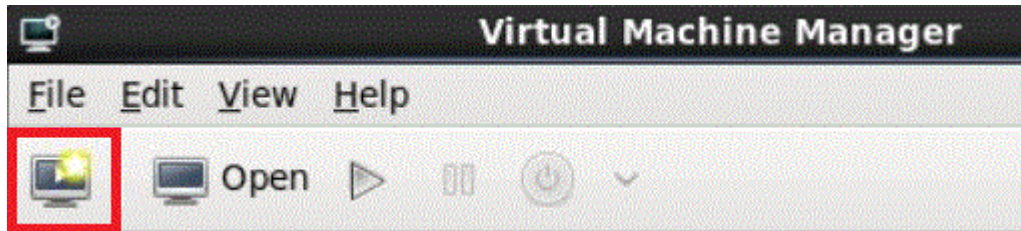
**NOTE:** You must have admin rights on the host OS to use `virt-manager`.

Figure 2: virt-manager



3. Click **Create a new virtual machine** as seen in [Figure 3 on page 23](#). The New VM wizard appears .

Figure 3: Create a New Virtual Machine



4. Select **Import existing disk image**, and click **Forward**.
5. Browse to the location of the downloaded vSRX Virtual Firewall QCOW2 image and select the vSRX Virtual Firewall image.
6. Select **Linux** from the OS type list and select **Show all OS options** from the Version list.
7. Select **Red Hat Enterprise Linux 7** from the expanded Version list and click **Forward**.
8. Set the RAM to 4096 MB and set CPUs to 2. Click **Forward**.
9. Set the disk image size to 16 GB and click **Forward**.
10. Name the vSRX Virtual Firewall VM, and select **Customize this configuration before install** to change parameters before you create and launch the VM. Click **Finish**. The Configuration dialog box appears.
11. Select **Processor** and expand the **Configuration** list.
12. Select **Copy Host CPU Configuration**.
13. Set CPU Feature **invts** to disabled on CPUs that support that feature. Set **vmx** to require for optimal throughput. You can optionally set **aes** to require for improved cryptographic throughput

**NOTE:** If the CPU feature option is not present in your version of **virt-manager**, you need start and stop the VM once, and then edit the vSRX Virtual Firewall VM XML file, typically found in `/etc/libvirt/qemu` directory on your host OS. Use `virsh edit` to edit the VM XML file to configure `<feature policy='require' name='vmx'/>` under the `<cpu mode>` element. Also add `<feature policy='disable' name='invts'/>` if your host OS supports this CPU flag. Use the `virsh capabilities` command on your host OS to list the host OS and CPU virtualization capabilities.

The following example shows the relevant portion of the vSRX Virtual Firewall XML file on a CentOS host:

```
<cpu mode='custom' match='exact'>
  <model fallback='allow'>SandyBridge</model>
  <vendor>Intel</vendor>
  <feature policy='require' name='pbe'/>
  <feature policy='require' name='tm2'/>
</cpu>
```



```

<feature policy='require' name='est' />
<feature policy='require' name='vmx' />
<feature policy='require' name='osxsave' />
<feature policy='require' name='smx' />
<feature policy='require' name='ss' />
<feature policy='require' name='ds' />
<feature policy='require' name='vme' />
<feature policy='require' name='dtes64' />
<feature policy='require' name='monitor' />
<feature policy='require' name='ht' />
<feature policy='require' name='dca' />
<feature policy='require' name='pcid' />
<feature policy='require' name='tm' />
<feature policy='require' name='pdcml' />
<feature policy='require' name='pdpe1gb' />
<feature policy='require' name='ds_cpl' />
<feature policy='require' name='xtpr' />
<feature policy='require' name='acpi' />
<feature policy='disable' name='invtscl' />
</cpu>

```

14. Select the disk and expand **Advanced Options**.
15. Select **IDE** from the Disk bus list.
16. Select the NIC, and select **virtio** from the Device model field. This first NIC is the fpx0 (management) interface for vSRX Virtual Firewall.
17. Click **Add Hardware** to add more virtual networks, and select **virtio** from the Device model list.
18. Click **Apply**, and click **x** to close the dialog box.
19. Click **Begin Installation**. The VM manager creates and launches the vSRX Virtual Firewall VM.

**NOTE:** The default vSRX Virtual Firewall VM login ID is root with no password. By default, if a DHCP server is on the network, it assigns an IP address to the vSRX Virtual Firewall VM.

## Install vSRX Virtual Firewall with virt-install

Ensure that you have already installed KVM, qemu, virt-install, and libvirt on your host OS. You must also configure the required virtual networks and storage pool in the host OS for the vSRX Virtual Firewall VM. See your host OS documentation for details.

**NOTE:** You must have root access on the host OS to use the `virt-install` command.

The `virt-install` and `virsh` tools are CLI alternatives to installing and managing vSRX Virtual Firewall VMs on a Linux host.

To install vSRX Virtual Firewall with `virt-install`:

1. Download the vSRX Virtual Firewall QCOW2 image from the Juniper software download site.
2. On your host OS, use the **virt-install** command with the mandatory options listed in [Table 11 on page 25](#).

**NOTE:** See the official `virt-install` documentation for a complete description of available options.

**Table 11: virt-install Options**

Command Option	Description
<code>--name <i>name</i></code>	Name the vSRX Virtual Firewall VM.
<code>--ram <i>megabytes</i></code>	Allocate RAM for the VM, in megabytes.
<code>--cpu <i>cpu-model, cpu-flags</i></code>	<p>Enable the <code>vmx</code> feature for optimal throughput. You can also enable <code>aes</code> for improved cryptographic throughput.</p> <p><b>NOTE:</b> CPU flag support depends on your host OS and CPU.</p> <p>Use <code>virsh capabilities</code> to list the virtualization capabilities of your host OS and CPU.</p>
<code>--vcpus <i>number</i></code>	Allocate the number of vCPUs for the vSRX Virtual Firewall VM.

Table 11: virt-install Options (Continued)

Command Option	Description
<code>--disk <i>path</i></code>	Specify disk storage media and size for the VM. Include the following options: <ul style="list-style-type: none"> <li>• <code>size=gigabytes</code></li> <li>• <code>device=disk</code></li> <li>• <code>bus=ide</code></li> <li>• <code>format=qcow2</code></li> </ul>
<code>--os-type <i>os-type</i></code> <code>--os-variant <i>os-type</i></code>	Configure the guest OS type and variant.
<code>--import</code>	Create and boot the vSRX Virtual Firewall VM from an existing image.

The following example creates a vSRX Virtual Firewall VM with 4096 MB RAM, 2 vCPUs, and disk storage up to 16 GB:

```
hostOS# virt-install --name vSRXVM --ram 4096 --cpu SandyBridge,+vmx,-invtscl --vcpus=2 --arch=x86_64 --disk path=/mnt/vsrx.qcow2,size=16,device=disk,bus=ide,format=qcow2 --os-type linux --os-variant rhel7 --import
```

The following example shows the relevant portion of the vSRX Virtual Firewall XML file on a CentOS host:

```
<cpu mode='custom' match='exact'>
  <model fallback='allow'>SandyBridge</model>
  <vendor>Intel</vendor>
  <feature policy='require' name='pbe' />
  <feature policy='require' name='tm2' />
  <feature policy='require' name='est' />
  <feature policy='require' name='vmx' />
  <feature policy='require' name='osxsave' />
  <feature policy='require' name='smx' />
  <feature policy='require' name='ss' />
  <feature policy='require' name='ds' />
```

```
<feature policy='require' name='vme' />
<feature policy='require' name='dtes64' />
<feature policy='require' name='monitor' />
<feature policy='require' name='ht' />
<feature policy='require' name='dca' />
<feature policy='require' name='pcid' />
<feature policy='require' name='tm' />
<feature policy='require' name='pdcn' />
<feature policy='require' name='pdpe1gb' />
<feature policy='require' name='ds_cpl' />
<feature policy='require' name='xtpr' />
<feature policy='require' name='acpi' />
<feature policy='disable' name='invtrsc' />
</cpu>
```

**NOTE:** The default vSRX Virtual Firewall VM login ID is root with no password. By default, if a DHCP server is on the network, it assigns an IP address to the vSRX Virtual Firewall VM.

## RELATED DOCUMENTATION

[Installing a virtual machine using virt-install](#)

[Migration, Upgrade, and Downgrade](#)

[Linux CPU Flags](#)

## Example: Install and Launch vSRX Virtual Firewall on Ubuntu

### IN THIS SECTION

- [Requirements | 28](#)
- [Overview | 28](#)
- [Quick Configuration - Install and Launch a vSRX Virtual Firewall VM on Ubuntu | 29](#)
- [| 32](#)
- [Step by Step Configuration | 32](#)

This example shows how to install and launch a vSRX Virtual Firewall instance on an Ubuntu server with KVM.

## Requirements

This example uses the following hardware and software components:

- Generic x86 server
- Junos OS Release 15.1X49-D20 for vSRX Virtual Firewall
- Ubuntu version 14.04.2

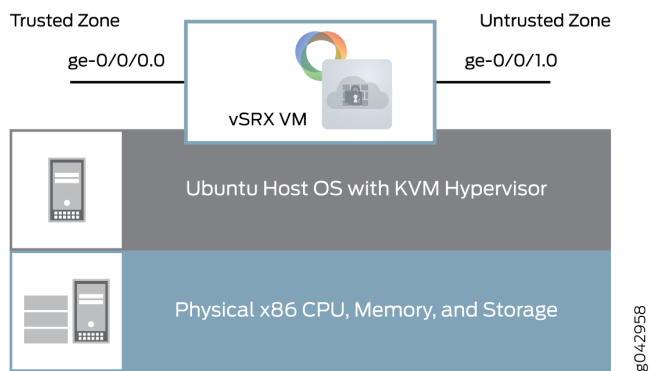
Before you begin:

- This example assumes a fresh install of the Ubuntu server software.
- Ensure that your host OS meets the requirements specified in *Requirements for vSRX on KVM*.

## Overview

This example shows how to set up your Ubuntu host server and install and launch a vSRX Virtual Firewall VM. [Figure 4 on page 28](#) shows the basic structure of a vSRX Virtual Firewall VM on an Ubuntu server.

**Figure 4: vSRX Virtual Firewall VM on Ubuntu**



**NOTE:** This example uses static IP addresses. If you are configuring the vSRX Virtual Firewall instance in an *NFV* environment, you should use DHCP.

## Quick Configuration - Install and Launch a vSRX Virtual Firewall VM on Ubuntu

### IN THIS SECTION

- [CLI Quick Configuration | 29](#)
- [Procedure | 29](#)

### CLI Quick Configuration

To quickly configure this example, copy the following commands, paste them into a text file, remove any line breaks, change any details necessary to match your network configuration, and copy and paste the commands into the Ubuntu server terminal or vSRX Virtual Firewall console as specified.

### Procedure

#### Step-by-Step Procedure

1. If the default virtual network does not already exist, copy the following commands and paste them into the Ubuntu server terminal to create the default virtual network.

```
cat <<EOF> /etc/libvirt/qemu/networks/default.xml
<network>
  <name>default</name>
  <forward mode='nat' />
  <nat>
    <port start='1024' end='65535' />
  </nat>
  <bridge name='virbr0' stp='on' delay='0' />
  <ip address='192.168.2.1' netmask='255.255.255.0'>
    <dhcp>
      <range start='192.168.2.2' end='192.168.2.254' />
    </dhcp>
  </ip>
</network>
EOF
virsh net-define /etc/libvirt/qemu/networks/default.xml
virsh net-start default
```

```
virsh net-autostart default
```

2. Create the left, or trusted, virtual network on the Ubuntu server.

```
cat <<EOF> /etc/libvirt/qemu/networks/testleftnetwork.xml
<network>
  <name>TestLeft</name>
  <forward mode='route' />
  <bridge name='virbr1' stp='on' delay='0' />
  <ip address='192.168.123.1' netmask='255.255.255.0'>
  <dhcp>
    <range start='192.168.123.100' end='192.168.123.250' />
  </dhcp>
</ip>
</network>
EOF
virsh net-define /etc/libvirt/qemu/networks/testleftnetwork.xml
virsh net-start TestLeft
virsh net-autostart TestLeft
```

3. Create the right, or untrusted, virtual network on the Ubuntu server.

```
cat <<EOF > /etc/libvirt/qemu/networks/testrightnetwork.xml
<network>
  <name>TestRight</name>
  <forward mode='nat' />
<nat>
  <port start ='1024' end='65535' />
</nat>
  <bridge name='virbr2' stp='on' delay='0' />
  <ip address='192.168.124.1' netmask='255.255.255.0'>
  <dhcp>
    <range start='192.168.124.100' end='192.168.124.250' />
  </dhcp>
</ip>
</network>
EOF
virsh net-define /etc/libvirt/qemu/networks/testrightnetwork.xml
virsh net-start TestRight
```

```
virsh net-autostart TestRight
```

4. Download the vSRX Virtual Firewall KVM image from the Juniper Networks website at <https://www.juniper.net/support/downloads/?p=vsrx#sw>.
5. Copy the following commands and modify the `cpu` parameter and flags to match your Ubuntu server CPU. Paste the resulting commands into the Ubuntu server terminal to copy the image to a mount point and create the vSRX Virtual Firewall VM.

```
cp junos-vsrx-vm-disk-15.1X49-D20.2.qcow2 /mnt/vsrx20one.qcow2
virt-install --name vsrx20one --ram 4096 --cpu SandyBridge,+vmx,-invts, --vcpus=2 --
arch=x86_64 --disk path=/mnt/vsrx20one.qcow2,size=16,device=disk,bus=ide,format=qcow2 --os-
type linux --os-variant rhel7 --import --network=network:default,model=virtio --
network=network:TestLeft,model=virtio --network=network:TestRight,model=virtio
```

**NOTE:** The CPU model and flags in the `virt-install` command might vary based on the CPU and features in the Ubuntu server.

6. To set the root password on the vSRX Virtual Firewall VM, copy and paste the command into the vSRX Virtual Firewall CLI at the `[edit]` hierarchy level.

```
set system root-authentication plain-text-password
```

7. To create a base configuration on the vSRX Virtual Firewall VM, copy the following commands, paste them into a text file, remove any line breaks, change any details necessary to match your network configuration, copy and paste the following commands into the vSRX Virtual Firewall CLI at the `[edit]` hierarchy level, and then enter `commit` from configuration mode.

```
set interfaces fxp0 unit 0 family inet dhcp-client
set interfaces ge-0/0/0 unit 0 family inet address 192.168.123.254/24
set interfaces ge-0/0/1 unit 0 family inet dhcp-client
set security zones security-zone trust interfaces ge-0/0/0.0 host-inbound-traffic system-
services all
set security zones security-zone untrust interfaces ge-0/0/1.0 host-inbound-traffic system-
services dhcp
set routing-instances CUSTOMER-VR instance-type virtual-router
set routing-instances CUSTOMER-VR interface ge-0/0/0.0
```



```
set routing-instances CUSTOMER-VR interface ge-0/0/1.0
set security nat source rule-set source-nat from zone trust
set security nat source rule-set source-nat to zone untrust
set security nat source rule-set source-nat rule nat1 match source-address 0.0.0.0/0
set security nat source rule-set source-nat rule nat1 then source-nat interface
```

#### IN THIS SECTION

- | 32

## Step-by-Step Procedure

### Step by Step Configuration

#### IN THIS SECTION

- Add Virtual Networks | 33
- Verify the Virtual Networks | 36
- Download and Installing the vSRX Virtual Firewall Image | 37
- Verify the vSRX Virtual Firewall Installation | 37
- Create a Base Configuration on the vSRX Virtual Firewall Instance | 40
- Verify the Basic Configuration on the vSRX Virtual Firewall Instance | 43

Use the following sections for a more detailed set of procedures to install and launch a vSRX Virtual Firewall VM.

## Add Virtual Networks

### Step-by-Step Procedure

You need to create virtual networks on the Ubuntu server to provide network connectivity to interfaces on the vSRX Virtual Firewall VM. Copy and paste these command into a terminal on the Ubuntu server.

This example uses three virtual networks:

- default— Connects the fxp0 management interface.

**NOTE:** The default virtual network should already exist on the Ubuntu server. Use the `virsh net-list` command to verify that the default network is present and active.

- TestLeft— Connects the ge-0/0/0 interface to the trusted zone.
- TestRight— Connects the ge-0/0/1 interface to the untrusted zone.

1. If the default network does not exist, follow these steps:

### Step-by-Step Procedure

- a. Open a text editor on the Ubuntu server and create the default network XML (**default.xml**) file.

```
emacs /etc/libvirt/qemu/networks/default.xml
```

- b. Set the forward mode to `nat`, configure an IP address and subnet mask, and a bridge interface, and configure DHCP to assign IP addresses to interfaces on this virtual network.

**NOTE:** Use the XML format specified by libvirt.

```
<network>
  <name>default</name>
  <forward mode='nat' />
<nat>
  <port start='1024' end='65535' />
</nat>
<bridge name='virbr0' stp='on' delay='0' />
```

```
<ip address='192.168.2.1' netmask='255.255.255.0'>
<dhcp>
  <range start='192.168.2.2' end='192.168.2.254' />
</dhcp>
</ip>
</network>
```

- c. Define and start the default virtual network, based on the **default.xml** file you created.

```
virsh net-define /etc/libvirt/qemu/networks/default.xml
virsh net-start default
virsh net-autostart default
```

2. Remove any previously configured TestLeft virtual network.

```
virsh net-destroy TestLeft
virsh net-undefine TestLeft
```

3. Remove any previously configured TestRight virtual network.

```
virsh net-destroy TestRight
virsh net-undefine TestRight
```

4. Open a text editor on the Ubuntu server and create the TestLeft network XML (**testleftnetwork.xml**) file.

```
emacs /etc/libvirt/qemu/networks/testleftnetwork.xml
```

5. Set the forward mode to route, configure an IP address and subnet mask, and a bridge interface, and configure DHCP to assign IP addresses to interfaces on this virtual network.

**NOTE:** Use the XML format specified by libvirt.

```
<network>
  <name>TestLeft</name>
  <forward mode='route' />
  <bridge name='virbr1' stp='on' delay='0' />
  <ip address='192.168.123.1' netmask='255.255.255.0'>
  <dhcp>
    <range start='192.168.123.100' end='192.168.123.250' />
  </dhcp>
</ip>
</network>
```

6. Open a text editor on the Ubuntu server and create the TestRight network XML (`testrightnetwork.xml`) file.

```
emacs /etc/libvirt/qemu/networks/testrightnetwork.xml
```

7. Set the forward mode to `nat`, configure an IP address and subnet mask, and a bridge interface, and configure DHCP to assign IP addresses to interfaces on this virtual network.

**NOTE:** Use the XML format specified by libvirt.

```
<network>
  <name>TestRight</name>
  <forward mode='nat' />
  <nat>
    <port start='1024' end='65535' />
  </nat>
  <bridge name='virbr2' stp='on' delay='0' />
  <ip address='192.168.124.1' netmask='255.255.255.0'>
  <dhcp>
    <range start='192.168.124.100' end='192.168.124.250' />
  </dhcp>
</ip>
</network>
```

- Define and start the TestLeft virtual network, based on the `testleftnetwork.xml` file you created.

```
virsh net-define /etc/libvirt/qemu/networks/testleftnetwork.xml
virsh net-start TestLeft
virsh net-autostart TestLeft
```

- Define and start the TestRight virtual network, based on the `testrightnetwork.xml` file you created.

```
virsh net-define /etc/libvirt/qemu/networks/testrightnetwork.xml
virsh net-start TestRight
virsh net-autostart TestRight
```

## Verify the Virtual Networks

### Purpose

Verify the new virtual network configuration on the Ubuntu server.

### Action

Use the `virsh net-list` command on the Ubuntu server to verify that the new virtual interfaces are active and are set to autostart on reboot.

```
virsh net-list
```

Name	State	Autostart	Persistent
-----			
default	active	yes	yes
TestLeft	active	yes	yes
TestRight	active	yes	yes

## Download and Installing the vSRX Virtual Firewall Image

### Step-by-Step Procedure

To download and install the vSRX Virtual Firewall image on the Ubuntu server:

1. Download the vSRX Virtual Firewall KVM image from the Juniper Networks website: <https://www.juniper.net/support/downloads/?p=vsrx#sw>
2. Copy the vSRX Virtual Firewall image to an appropriate mount point.

```
hostOS# cp junos-vsrx-vmdisk-15.1X49-D20.2.qcow2 /mnt/vsrx20one.qcow2
```

3. Use the `virt-install` command to create a vSRX Virtual Firewall VM. Modify the `cpu` parameter and flags to match your Ubuntu server CPU.

```
hostOS# virt-install --name vsrx20one --ram 4096 --cpu SandyBridge,+vmx,-invts, --vcpus=2 --arch=x86_64 --disk path=/mnt/vsrx20one.qcow2,size=16,device=disk,bus=ide,format=qcow2 --os-type linux --os-variant rhel7 --import --network=network:default,model=virtio --network=network:TestLeft,model=virtio --network=network:TestRight,model=virtio
```

**NOTE:** The CPU model and flags in the `virt-install` command might vary based on the CPU and features in the Ubuntu server.

## Verify the vSRX Virtual Firewall Installation

### Purpose

Verify the vSRX Virtual Firewall Installation.

## Action

1. Use the `virsh console` command on the Ubuntu server to access the vSRX Virtual Firewall console and watch the progress of the installation. The installation can take several minutes to complete.

```
hostOS# virsh console vSRx200ne
```

```
Starting install...
ERROR   internal error: process exited while connecting to monitor: libust[11994/11994]:
Warning: HOME environment variable not set. Disabling LTTng-UST per-user tracing. (in
setup_local_apps() at lttng-ust-comm.c:305)
libust[11994/11995]: Error: Error opening shm /lttng-ust-wait-5 (in get_wait_shm() at lttng-
ust-comm.c:886)
libust[11994/11995]: Error: Error opening shm /lttng-ust-wait-5 (in get_wait_shm() at lttng-
ust-comm.c:886)
```

```
Booting `Juniper Linux'
```

```
Loading Linux ...
```

```
Consoles: serial port
```

```
BIOS drive C: is disk0
```

```
BIOS drive D: is disk1
```

```
BIOS drive E: is disk2
```

```
BIOS drive F: is disk3
```

```
BIOS 639kB/999416kB available memory
```

```
FreeBSD/i386 bootstrap loader, Revision 1.2
```

```
(builder@example.com, Thu Jul 30 23:20:10 UTC 2015)
```

```
Loading /boot/defaults/loader.conf
```

```
/kernel text=0xa3a2c0 data=0x6219c+0x11f8e0 syms=[0x4+0xb2ed0+0x4+0x1061bb]
```

```
/boot/modules/libmbpool.ko text=0xce8 data=0x114
```

```
/boot/modules/if_em_vsrx.ko text=0x184c4 data=0x7fc+0x20
```

```
/boot/modules/virtio.ko text=0x2168 data=0x208 syms=[0x4+0x7e0+0x4+0x972]
```

```
/boot/modules/virtio_pci.ko text=0x2de8 data=0x200+0x8 syms=[0x4+0x8f0+0x4+0xb22]
```

```
/boot/modules/virtio_blk.ko text=0x299c data=0x1dc+0xc syms=[0x4+0x960+0x4+0xa0f]
```

```
/boot/modules/if_vtnet.ko text=0x5ff0 data=0x360+0x10 syms=[0x4+0xdf0+0x4+0xf19]
```

```
/boot/modules/pci_hgcomm.ko text=0x12fc data=0x1a4+0x44 syms=[0x4+0x560+0x4+0x61d]
```

```
/boot/modules/chassis.ko text=0x9bc data=0x1d0+0x10 syms=[0x4+0x390+0x4+0x399]
```

```
Hit [Enter] to boot immediately, or space bar for command prompt.
```

```
Booting [/kernel]...
platform_early_bootinit: Early Boot Initialization
GDB: debug ports: sio
GDB: current port: sio
KDB: debugger backends: ddb gdb
KDB: current backend: ddb
Copyright (c) 1996-2015, Juniper Networks, Inc.
All rights reserved.
Copyright (c) 1992-2007 The FreeBSD Project.
Copyright (c) 1979, 1980, 1983, 1986, 1988, 1989, 1991, 1992, 1993, 1994
    The Regents of the University of California. All rights reserved.
FreeBSD is a registered trademark of The FreeBSD Foundation.
JUNOS 15.1X49-D15.4 #0: 2015-07-31 02:20:21 UTC

<output omitted>

The machine id is empty.
Cleaning up ...
Thu Aug 27 12:06:22 UTC 2015
Aug 27 12:06:22 init: exec_command: /usr/sbin/dhcpd (PID 1422) started
Aug 27 12:06:22 init: dhcp (PID 1422) started
Aug 27 12:06:23 init: exec_command: /usr/sbin/pppd (PID 1428) started

Amnesiac (ttyd0)

login:
```



2. On the vSRX Virtual Firewall console, log in and verify the vSRX Virtual Firewall version installed.

```
login: root
```

```
--- JUNOS 15.1X49-D15.4 built 2015-07-31 02:20:21 UTC
```

```
root%
```

```
root% cli
```

```
root>
```

```
root> show version
```

```
Model: vSRX  
Junos: 15.1X49-D15.4  
JUNOS Software Release [15.1X49-D15.4]
```

## Create a Base Configuration on the vSRX Virtual Firewall Instance

### Step-by-Step Procedure

To configure a base setup on the vSRX Virtual Firewall instance, enter the following steps in edit mode:

1. Create a root password.

```
[edit]  
set system root-authentication plain-text-password
```

2. Set the IP address family for the management interface, and enable the DHCP client for this interface.

```
set interfaces fxp0 unit 0 family inet dhcp-client
```

3. Set the IP address for the ge-0/0/0.0 interface.

```
set interfaces ge-0/0/0 unit 0 family inet address 192.168.123.254/24
```

4. Set the IP address family for the ge-0/0/1.0 interface, and enable the DHCP client for this interface.

```
set interfaces ge-0/0/1 unit 0 family inet dhcp-client
```

5. Add the ge-0/0/0.0 interface to the trust security zone and allow all system services from inbound traffic on that interface.

```
set security zones security-zone trust interfaces ge-0/0/0.0 host-inbound-traffic system-services all
```

6. Add the ge-0/0/1.0 interface to the untrust security zone and allow only DHCP system services from inbound traffic on that interface.

```
set security zones security-zone untrust interfaces ge-0/0/1.0 host-inbound-traffic system-services dhcp
```

7. Create a virtual router routing instance and add the two interfaces to that routing instance.

```
set routing-instances CUSTOMER-VR instance-type virtual-router
set routing-instances CUSTOMER-VR interface ge-0/0/0.0
set routing-instances CUSTOMER-VR interface ge-0/0/1.0
```

8. Create a source NAT rule set.

```
set security nat source rule-set source-nat from zone trust
set security nat source rule-set source-nat to zone untrust
```

9. Configure a rule that matches packets and translates the source address to the address of the egress interface.

```
set security nat source rule-set source-nat rule nat1 match source-address 0.0.0.0/0
set security nat source rule-set source-nat rule nat1 then source-nat interface
```

## Results

From configuration mode, confirm your configuration by entering the `show interfaces` command. If the output does not display the intended configuration, repeat the instructions in this example to correct the configuration.

```
show interfaces
```

From configuration mode, confirm your security policies by entering the `show security policies` command. If the output does not display the intended configuration, repeat the instructions in this example to correct the configuration.

```
show security policies
```

```
from-zone trust to-zone trust {
  policy default-permit {
    match {
      source-address any;
      destination-address any;
      application any;
    }
    then {
      permit;
    }
  }
}
from-zone trust to-zone untrust {
  policy default-permit {
    match {
      source-address any;
      destination-address any;
      application any;
```

```
    }
    then {
        permit;
    }
}
}
from-zone untrust to-zone trust {
    policy default-deny {
        match {
            source-address any;
            destination-address any;
            application any;
        }
        then {
            deny;
        }
    }
}
```

If you are done configuring the device, enter `commit` from configuration mode.

**NOTE:** As a final step, exit configuration mode and use the `request system reboot` command to reboot the vSRX Virtual Firewall VM. You can use the `virsh console` command on the Ubuntu server to reconnect to the vSRX Virtual Firewall after reboot.

## Verify the Basic Configuration on the vSRX Virtual Firewall Instance

### Purpose

Verify the basic configuration on the vSRX Virtual Firewall instance.

## Action

Verify that the ge-0/0/0.0 interface has an assigned IP address from the TestLeft network DHCP address range, and that the ge-0/0/1.0 has an assigned IP address from the TestRight network DHCP address range.

```
root> show interfaces terse
```

Interface	Admin	Link	Proto	Local	Remote
ge-0/0/0	up	up			
ge-0/0/0.0	up	up	inet	192.168.123.254/24	
gr-0/0/0	up	up			
ip-0/0/0	up	up			
lsq-0/0/0	up	up			
lt-0/0/0	up	up			
mt-0/0/0	up	up			
sp-0/0/0	up	up			
sp-0/0/0.0	up	up	inet		
			inet6		
sp-0/0/0.16383	up	up	inet		
ge-0/0/1	up	up			
ge-0/0/1.0	up	up	inet	192.168.124.238/24	
dsc	up	up			
em0	up	up			
em0.0	up	up	inet	128.0.0.1/2	
em1	up	up			
em1.32768	up	up	inet	192.168.1.2/24	
em2	up	up			
fxp0	up	up			
fxp0.0	up	up	inet	192.168.2.1/24	
ipip	up	up			
irb	up	up			
lo0	up	up			
lo0.16384	up	up	inet	127.0.0.1	--> 0/0
lo0.16385	up	up	inet	10.0.0.1	--> 0/0
				10.0.0.16	--> 0/0
				128.0.0.1	--> 0/0
				128.0.0.4	--> 0/0
				128.0.1.16	--> 0/0
lo0.32768	up	up			
lsi	up	up			

```

mtun          up    up
pimd         up    up
pime         up    up
pp0          up    up
ppd0        up    up
ppe0        up    up
st0          up    up
tap          up    up
vlan         up    down

```

## RELATED DOCUMENTATION

[libvirt Network XML Format](#)

[libvirt Command Reference](#)

## Load an Initial Configuration on a vSRX Virtual Firewall with KVM

### IN THIS SECTION

- [Create a vSRX Virtual Firewall Bootstrap ISO Image | 46](#)
- [Provision vSRX Virtual Firewall with an ISO Bootstrap Image on KVM | 47](#)

Starting in Junos OS Release 15.1X49-D40 and Junos OS Release 17.3R1, you can use a mounted ISO image to pass the initial startup Junos OS configuration to a vSRX Virtual Firewall VM. This ISO image contains a file in the root directory called `juniper.conf`. This file uses the standard Junos OS command syntax to define configuration details, such as root password, management IP address, default gateway, and other configuration statements.

The process to bootstrap a vSRX Virtual Firewall VM with an ISO configuration image is as follows:

**NOTE:** SNMPv3 configuration is not supported when provisioning the vSRX Virtual Firewall platforms with an ISO bootstrap image.

1. Create the `juniper.conf` configuration file with your Junos OS configuration.

2. Create an ISO image that includes the **juniper.conf** file.
3. Mount the ISO image to the vSRX Virtual Firewall VM.
4. Boot or reboot the vSRX Virtual Firewall VM. vSRX Virtual Firewall will boot using the **juniper.conf** file included in the mounted ISO image.
5. Unmount the ISO image from the vSRX Virtual Firewall VM.

**NOTE:** If you do not unmount the ISO image after the initial boot or reboot, all subsequent configuration changes to the vSRX Virtual Firewall are overwritten by the ISO image on the next reboot.

## Create a vSRX Virtual Firewall Bootstrap ISO Image

This task uses a Linux system to create the ISO image.

To create a vSRX Virtual Firewall bootstrap ISO image:

1. Create a configuration file in plaintext with the Junos OS command syntax and save in a file called **juniper.conf**.
2. Create a new directory.

```
hostOS$ mkdir iso_dir
```

3. Copy **juniper.conf** to the new ISO directory.

```
hostOS$ cp juniper.conf iso_dir
```

**NOTE:** The **juniper.conf** file must contain the full vSRX Virtual Firewall configuration. The ISO bootstrap process overwrites any existing vSRX Virtual Firewall configuration.

4. Use the Linux `mkisofs` command to create the ISO image.

```
hostOS$ mkisofs -l -o test.iso iso_dir
```

```
I: -input-charset not specified, using utf-8 (detected in locale settings)
Total translation table size: 0
Total rockridge attributes bytes: 0
Total directory bytes: 0
Path table size(bytes): 10
Max brk space used 0
175 extents written (0 MB)
```

**NOTE:** The `-l` option allows for a long filename.

## Provision vSRX Virtual Firewall with an ISO Bootstrap Image on KVM

To provision a vSRX Virtual Firewall VM from an ISO bootstrap image:

1. Use the `virsh edit` command on the KVM host server where the vSRX Virtual Firewall VM resides to add the bootstrap ISO image as a disk device.

```
<disk type='file' device='cdrom'>
  <driver name='qemu' type='raw' />
  <source file='/home/test.iso' />
  <target dev='hdc' bus='ide' />
  <readonly />
  <address type='drive' controller='0' bus='1' target='0' unit='0' />
</disk>
```

2. Boot or reboot the vSRX Virtual Firewall VM.

```
user@host# virsh start ixvSRX
```

```
Connected to domain ixvSRX
```



- Optionally, use the `virsh domblklist` Linux command to verify that the bootstrap ISO image is part of the VM.

```
hostOS# virsh domblklist ixvSRX
```

```

Target      Source
-----
hda         /home/test/vsrx209.qcow2
hdc         /home/test/test.iso

```

- Verify the configuration, then power down the vSRX Virtual Firewall VM to remove the ISO image.
- Use the `virsh edit` command on the KVM host server to remove the ISO image xml statements added in step 1, and then reboot the vSRX Virtual Firewall VM.

#### Release History Table

Release	Description
15.1X49-D80	Starting in Junos OS Release 15.1X49-D40 and Junos OS Release 17.3R1, you can use a mounted ISO image to pass the initial startup Junos OS configuration to a vSRX Virtual Firewall VM. This ISO image contains a file in the root directory called <code>juniper.conf</code> . This file uses the standard Junos OS command syntax to define configuration details, such as root password, management IP address, default gateway, and other configuration statements.

#### RELATED DOCUMENTATION

| [Linux mkisofs command](#)

## Use Cloud-Init in an OpenStack Environment to Automate the Initialization of vSRX Virtual Firewall Instances

#### IN THIS SECTION

- [Perform Automatic Setup of a vSRX Virtual Firewall Instance Using an OpenStack Command-Line Interface | 52](#)

- Perform Automatic Setup of a vSRX Virtual Firewall Instance from the OpenStack Dashboard (Horizon) | 54

Starting in Junos OS Release 15.1X49-D100 and Junos OS Release 17.4R1, the cloud-init package (version 0.7x) comes pre-installed in the vSRX Virtual Firewall image to help simplify configuring new vSRX Virtual Firewall instances operating in an OpenStack environment according to a specified user-data file. Cloud-init is performed during the first-time boot of a vSRX Virtual Firewall instance.

Cloud-init is an OpenStack software package for automating the initialization of a cloud instance at boot-up. It is available in Ubuntu and most major Linux and FreeBSD operating systems. Cloud-init is designed to support multiple different cloud providers so that the same virtual machine (VM) image can be directly used in multiple hypervisors and cloud instances without any modification. Cloud-init support in a VM instance runs at boot time (first-time boot) and initializes the VM instance according to the specified user-data file.

A user-data file is a special key in the metadata service that contains a file that cloud-aware applications in the VM instance can access upon a first-time boot. In this case, it is the validated Junos OS configuration file that you intend to upload to a vSRX Virtual Firewall instance as the active configuration. This file uses the standard Junos OS command syntax to define configuration details, such as root password, management IP address, default gateway, and other configuration statements.

When you create a vSRX Virtual Firewall instance, you can use cloud-init with a validated Junos OS configuration file (**juniper.conf**) to automate the initialization of new vSRX Virtual Firewall instances. The user-data file uses the standard Junos OS syntax to define all the configuration details for your vSRX Virtual Firewall instance. The default Junos OS configuration is replaced during the vSRX Virtual Firewall instance launch with a validated Junos OS configuration that you supply in the form of a user-data file.

**NOTE:** If using a release *earlier* than Junos OS Release 15.1X49-D130 and Junos OS Release 18.4R1, the user-data configuration file cannot exceed 16 KB. If your user-data file exceeds this limit, you must compress the file using `gzip` and use the compressed file. For example, the `gzip junos.conf` command results in the `junos.conf.gz` file.

Starting in Junos OS Release 15.1X49-D130 and Junos OS Release 18.4R1, if using a configuration drive data source in an OpenStack environment, the user-data configuration file size can be up to 64 MB.

The configuration must be validated and include details for the `fxp0` interface, login, and authentication. It must also have a default route for traffic on `fxp0`. If any of this information is missing or incorrect, the instance is inaccessible and you must launch a new one.



**WARNING:** Ensure that the user-data configuration file is not configured to perform autoinstallation on interfaces using Dynamic Host Configuration Protocol (DHCP) to assign an IP address to the vSRX Virtual Firewall. Autoinstallation with DHCP will result in a "commit fail" for the user-data configuration file.

Starting in Junos OS Release 15.1X49-D130 and Junos OS Release 18.4R1, the cloud-init functionality in vSRX Virtual Firewall has been extended to support the use of a configuration drive data source in an OpenStack environment. The configuration drive uses the user-data attribute to pass a validated Junos OS configuration file to the vSRX Virtual Firewall instance. The user-data can be plain text or MIME file type text/plain. The configuration drive is typically used in conjunction with the Compute service, and is present to the instance as a disk partition labeled `config-2`. The configuration drive has a maximum size of 64 MB, and must be formatted with either the `vfat` or `ISO 9660` filesystem.

The configuration drive data source also provides the flexibility to add more than one file that can be used for configuration. A typical use case would be to add a Day0 configuration file and a license file. In this case, there are two methods that can be employed to use a configuration drive data source with a vSRX Virtual Firewall instance:

- User-data (Junos OS Configuration File) alone—This approach uses the user-data attribute to pass the Junos OS configuration file to each vSRX Virtual Firewall instance. The user-data can be plain text or MIME file type text/plain.
- Junos OS configuration file and license file—This approach uses the configuration drive data source to send the Junos OS configuration and license file(s) to each vSRX Virtual Firewall instance.

**NOTE:** If a license file is to be configured in vSRX Virtual Firewall, it is recommended to use the `-file` option rather than the `user-data` option to provide the flexibility to configure files larger than the 16 KB limit of user-data.

To use a configuration drive data source to send Junos OS configuration and license file(s) to a vSRX Virtual Firewall instance, the files need to be sent in a specific folder structure. In this application, the folder structure of the configuration drive data source in vSRX Virtual Firewall is as follows:

```
- OpenStack
  - latest
    - junos-config
      - configuration.txt
    - junos-license
```

- License\_file\_name.lic
- License\_file\_name.lic

```
//OpenStack//latest/junos-config/configuration.txt
```

```
//OpenStack//latest/junos-license/license.lic
```

Before you begin:

- Create a configuration file with the Junos OS command syntax and save it. The configuration file can be plain text or MIME file type text/plain. The string #junos-config must be the first line of the user-data configuration file before the Junos OS configuration.

**NOTE:** The #junos-config string is mandatory in the user-data configuration file; if it is not included, the configuration will not be applied to the vSRX Virtual Firewall instance as the active configuration.

- Determine the name for the vSRX Virtual Firewall instance you want to initialize with a validated Junos OS configuration file.
- Determine the flavor for your vSRX Virtual Firewall instance, which defines the compute, memory, and storage capacity of the vSRX Virtual Firewall instance.
- Starting in Junos OS Release 15.1X49-D130 and Junos OS Release 18.4R1, if using a configuration drive, ensure the following criteria is met to enable cloud-init support for a configuration drive in OpenStack:
  - The configuration drive must be formatted with either the vfat or iso9660 filesystem.

**NOTE:** The default format of a configuration drive is an ISO 9660 file system. To explicitly specify the ISO 9660/vfat format, add the config\_drive\_format=iso9660/vfat line to the nova.conf file.

- The configuration drive must have a filesystem label of config-2.
- The folder size must be no greater than 64 MB.

Depending on your OpenStack environment, you can use either an OpenStack command-line interface (such as nova boot or openstack server create) or the OpenStack Dashboard (“Horizon”) to launch and initialize a vSRX Virtual Firewall instance.

## Perform Automatic Setup of a vSRX Virtual Firewall Instance Using an OpenStack Command-Line Interface

You can launch and manage a vSRX Virtual Firewall instance using either the `nova boot` or `openstack server create` commands, which includes the use of a validated Junos OS configuration user-data file from your local directory to initialize the active configuration of the target vSRX Virtual Firewall instance.

To initiate the automatic setup of a vSRX Virtual Firewall instance from an OpenStack command-line client:

1. If you have not done so already, create a configuration file with the Junos OS command syntax and save the file. The configuration file can be plain text or MIME file type `text/plain`.

The user-data configuration file must contain the full vSRX Virtual Firewall configuration that is to be used as the active configuration on each vSRX Virtual Firewall instance, and the string `#junos-config` must be the first line of the user-data configuration file before the Junos OS configuration.

**NOTE:** The `#junos-config` string is mandatory in the user-data configuration file; if it is not included, the configuration will not be applied to the vSRX Virtual Firewall instance as the active configuration.

2. Copy the Junos OS configuration file to an accessible location from where it can be retrieved to launch the vSRX Virtual Firewall instance.
3. Depending on your OpenStack environment, use the `nova boot` or `openstack server create` command to launch the vSRX Virtual Firewall instance with a validated Junos OS configuration file as the specified user-data.

**NOTE:** You can also use the `nova boot` equivalent in an Orchestration service such as HEAT.

For example:

- `nova boot -user-data </path/to/vsrx_configuration.txt> --image vSRX_image --flavor vSRX_flavor_instance`
- `openstack server create -user-data </path/to/vsrx_configuration.txt> --image vSRX_image --flavor vSRX_flavor_instance`

Where:

`-user-data </path/to/vsrx_configuration.txt>` specifies the location of the Junos OS configuration file. The user-data configuration file size is limited to approximately 16,384 bytes.

`--image vSRX_image` identifies the name of a unique vSRX Virtual Firewall image.

`--flavor vSRX_flavor_instance` identifies the vSRX Virtual Firewall flavor (ID or name).

Starting in Junos OS Release 15.1X49-D130 and Junos OS Release 18.4R1, to enable the use of a configuration drive for a specific request in the OpenStack compute environment, include the `-config-drive true` parameter in the `nova boot` or `openstack server create` command.

**NOTE:** It is possible to enable the configuration drive automatically on all instances by configuring the OpenStack Compute service to always create a configuration drive. To do this, specify the `force_config_drive=True` option in the `nova.conf` file.

For example, to use the user-data attribute to pass the Junos OS configuration to each vSRX Virtual Firewall instance:

```
nova boot -config-drive true -flavor vSRX_flavor_instance -image vSRX_image -user-data </path/to/vsrx_configuration.txt>
```

Where:

`-user-data </path/to/vsrx_configuration.txt>` specifies the location of the Junos OS configuration file. The user-data configuration file size is limited to approximately 64 MB.

`-image vSRX_image` identifies the name of a unique vSRX Virtual Firewall image.

`-flavor vSRX_flavor_instance` identifies the vSRX Virtual Firewall flavor (ID or name).

For example, to specify the configuration drive with multiple files (Junos OS configuration file and license file):

```
nova boot -config-drive true -flavor vSRX_flavor_instance -image vSRX_image [-file /config/junos-config/configuration.txt=/path/to/file] [-file /junos-license/license.lic=/path/to/license]
```

Where:

`[-file /config/junos-config/configuration.txt=/path/to/file]` specifies the location of the Junos OS configuration file.

`[-file /junos-license/license.lic=/path/to/license]` specifies the location of the Junos OS configuration file.

`-image vSRX_image` identifies the name of a unique vSRX Virtual Firewall image.

`-flavor vSRX_flavor_instance` identifies the vSRX Virtual Firewall flavor (ID or name).

4. Boot or reboot the vSRX Virtual Firewall instance. During the initial boot-up sequence, the vSRX Virtual Firewall instance processes the cloud-init request.

**NOTE:** The boot time for the vSRX Virtual Firewall instance might increase with the use of the cloud-init package. This additional time in the initial boot sequence is due to the operations performed by the cloud-init package. During this operation, the cloud-init package halts the boot sequence and performs a lookup for the configuration data in each data source identified in the cloud.cfg. The time required to look up and populate the cloud data is directly proportional to the number of data sources defined. In the absence of a data source, the lookup process continues until it reaches a predefined timeout of 30 seconds for each data source.

5. When the initial boot-up sequence resumes, the user-data file replaces the original factory-default Junos OS configuration loaded on the vSRX Virtual Firewall instance. If the commit succeeds, the factory-default configuration will be permanently replaced. If the configuration is not supported or cannot be applied to the vSRX Virtual Firewall instance, the vSRX Virtual Firewall will boot using the default Junos OS configuration.

## SEE ALSO

[Cloud-Init Documentation](#)

[OpenStack command-line clients](#)

[Compute service \(nova\) command-line client](#)

[Openstack Server Create](#)

[Enabling the configuration drive \(configdrive\)](#)

[Instances](#)

## Perform Automatic Setup of a vSRX Virtual Firewall Instance from the OpenStack Dashboard (Horizon)

Horizon is the canonical implementation of the OpenStack Dashboard. It provides a Web-based user interface to OpenStack services including Nova, Swift, Keystone, and so on. You can launch and manage a vSRX Virtual Firewall instance from the OpenStack Dashboard, which includes the use of a validated Junos OS configuration user-data file from your local directory to initialize the active configuration of the target vSRX Virtual Firewall instance.

To initiate the automatic setup of a vSRX Virtual Firewall instance from the OpenStack Dashboard:

1. If you have not done so already, create a configuration file with the Junos OS command syntax and save the file. The configuration file can be plain text or MIME file type text/plain.

The user-data configuration file must contain the full vSRX Virtual Firewall configuration that is to be used as the active configuration on each vSRX Virtual Firewall instance, and the string #junos-config must be the first line of the user-data configuration file before the Junos OS configuration.

**NOTE:** The #junos-config string is mandatory in the user-data configuration file; if it is not included, the configuration will not be applied to the vSRX Virtual Firewall instance as the active configuration.

2. Copy the Junos OS configuration file to an accessible location from where it can be retrieved to launch the vSRX Virtual Firewall instance.
3. Log in to the OpenStack Dashboard using your login credentials and then select the appropriate project from the drop-down menu at the top left.
4. On the Project tab, click the **Compute** tab and select **Instances**. The dashboard shows the various instances with its image name, its private and floating IP addresses, size, status, availability zone, task, power state, and so on.
5. Click **Launch Instance**. The Launch Instance dialog box appears.
6. From the Details tab (see [Figure 5 on page 55](#)), enter an instance name for the vSRX Virtual Firewall VM along with the associated availability zone (for example, Nova) and then click **Next**. We recommend that you keep this name the same as the hostname assigned to the vSRX Virtual Firewall VM.

**Figure 5: Launch Instance Details Tab**

Launch Instance

**Details**

Please provide the initial hostname for the instance, the availability zone where it will be deployed, and the instance count. Increase the Count to create multiple instances with the same settings.

**Source \***

**Flavor \***

**Networks \***

**Network Ports**

**Security Groups**

**Key Pair**

**Configuration**

**Metadata**

**Instance Name \***

vsrx-cloud-init-user-data

**Availability Zone**

nova

**Count \***

1

Total Instances (100000 Max)

0%

6 Current Usage

1 Added

99993 Remaining

✕ Cancel

< Back

Next >

Launch Instance



- From the Source tab (see [Figure 6 on page 56](#)), select a vSRX Virtual Firewall VM image source file from the Available list and then click **+(Plus)**. The selected vSRX Virtual Firewall image appears under Allocated. Click **Next**.

**Figure 6: Launch Instance Source Tab**

**Launch Instance**

**Source**

Instance source is the template used to create an instance. You can use a snapshot of an existing instance, an image, or a volume (if enabled). You can also choose to use persistent storage by creating a new volume.

**Select Boot Source**

Image

**Allocated**

Name	Updated	Size	Type	Visibility
> vsrx-cloud-init	5/6/17 5:46 AM	3.07 GB	QCOW2	Public

**Available** 3 Select one

Click here for filters.

Name	Updated	Size	Type	Visibility
> Centos_image	4/4/17 6:09 AM	12.67 MB	RAW	Public
> vsrx	5/10/17 5:25 PM	3.07 GB	QCOW2	Public
> vSRXD75	4/4/17 10:43 PM	2.90 GB	QCOW2	Public

- From the Flavor tab (see [Figure 7 on page 57](#)), select a vSRX Virtual Firewall instance with a specific compute, memory, and storage capacity from the Available list and then click **+(plus sign)**. The selected vSRX Virtual Firewall flavor appears under Allocated. Click **Next**.

Figure 7: Launch Instance Flavor Tab

Launch Instance

Flavors manage the sizing for the compute, memory and storage capacity of the instance.

Allocated

Name	VCPUS	RAM	Total Disk	Root Disk	Ephemeral Disk	Public	
> m1.medium	2	4 GB	40 GB	40 GB	0 GB	Yes	-

Available 6 Select one

Click here for filters.

Name	VCPUS	RAM	Total Disk	Root Disk	Ephemeral Disk	Public	
> m1.tiny	1	512 MB	1 GB	1 GB	0 GB	Yes	+
> m1.small	1	2 GB	20 GB	20 GB	0 GB	Yes	+
> vSRX2.0_3 CPU_	3	2.9 3 GB	2 GB	2 GB	0 GB	Yes	+
> vSRX2.0_3 CPU_3Intf	3	3.9 1 GB	16 GB	16 GB	0 GB	Yes	+
> m1.large	4	8 GB	80 GB	80 GB	0 GB	Yes	+
> m1.xlarge	8	16 GB	160 GB	160 GB	0 GB	Yes	+

- From the Networks tab (see [Figure 8 on page 58](#)), select the specific network of the vSRX Virtual Firewall instance from the Available list and then click **+(plus sign)**. The selected network appears under Allocated. Click **Next**.

**NOTE:** Do not update any parameters in the Network Ports, Security Groups, or Key Pair tabs in the Launch Instance dialog box.

Figure 8: Launch Instance Networks Tab

Launch Instance

Networks provide the communication channels for instances in the cloud.

▼ Allocated <sup>1</sup> Select networks from those listed below.

	Network	Subnets Associated	Shared	Admin State	Status	
↕ 1	MgmtVN	b9803761-3b3b-4853-b9a0-6f1cef808102	No	Up	Active	-

▼ Available <sup>4</sup> Select at least one network

🔍 Click here for filters.

	Network ^	Subnets Associated	Shared	Admin State	Status	
>	LeftVN	a6fd1f2a-4bcd-4485-a1da-491162d4abdc	No	Up	Active	+
>	MgmtVN2	cb5625bd-880f-4c2d-a50a-277ed48d6e0f	No	Up	Active	+
>	Other0VN	7466febf-a26a-47a3-8d0c-e1906661cf23	No	Up	Active	+
>	RightVN	516ded2c-b58f-4cfb-aba6-12e584de6b8b	No	Up	Active	+

✕ Cancel < Back Next > Launch Instance

- From the Configuration tab (see Figure 9 on page 59), click **Browse** and navigate to the location of the validated Junos OS configuration file from your local directory that you want to use as the user-data file. Click **Next**.

Figure 9: Launch Instance Configuration Tab

The screenshot shows the 'Launch Instance' dialog box with the 'Configuration' tab selected. The left sidebar contains the following tabs: Details, Source, Flavor, Networks, Network Ports, Security Groups, Key Pair, Configuration (highlighted), and Metadata. The main content area includes a help icon, a description of customization options, a 'Customization Script' section with a text area and a 'Script size: 0 bytes of 16.00 KB' indicator, a 'Load script from a file' section with a 'Choose File' button and 'No file chosen' text, a 'Disk Partition' dropdown menu set to 'Automatic', and an unchecked 'Configuration Drive' checkbox. At the bottom, there are buttons for 'Cancel', '< Back', 'Next >', and 'Launch Instance'.

11. Confirm that the loaded Junos OS configuration contains the `#junos-config` string in the first line of the user-data configuration file (see [Figure 10 on page 60](#)) and then click **Next**.

**NOTE:** Do not update any parameters in the Metadata tab of the Launch Instance dialog box.

Figure 10: Launch Instance Configuration Tab with Loaded Junos OS Configuration

The screenshot shows the 'Launch Instance' configuration window with the 'Configuration' tab selected. The 'Customization Script (Modified)' field contains the following Junos configuration:

```
#junos-config
## Last commit: 2017-05-01 18:43:01 UTC by root
version "15.1-2017-04-26.1_DEV_X_151_X49 [ssd-builder]";
groups {
  amoluser {
    system {
      root-authentication {
        ssh-rsa "ssh-rsa"
```

Below the script, the 'Load script from a file' section shows a 'Choose File' button and the text 'user-data'. The 'Disk Partition' dropdown is set to 'Automatic', and the 'Configuration Drive' checkbox is unchecked. At the bottom, there are buttons for 'Cancel', '< Back', 'Next >', and a red 'Launch Instance' button.

12. Click **Launch Instance**. During the initial boot-up sequence, the vSRX Virtual Firewall instance processes the cloud-init request.

**NOTE:** The boot time for the vSRX Virtual Firewall instance might increase with the use of the cloud-init package. This additional time in the initial boot sequence is due to the operations performed by the cloud-init package. During this operation, the cloud-init package halts the boot sequence and performs a lookup for the configuration data in each data source identified in the cloud.cfg. The time required to look up and populate the cloud data is directly proportional to the number of data sources defined. In the absence of a data source, the lookup process continues until it reaches a predefined timeout of 30 seconds for each data source.

13. When the initial boot-up sequence resumes, the user-data file replaces the original factory-default Junos OS configuration loaded on the vSRX Virtual Firewall instance. If the commit succeeds, the factory-default configuration will be permanently replaced. If the configuration is not supported or cannot be applied to the vSRX Virtual Firewall instance, the vSRX Virtual Firewall will boot using the default Junos OS configuration.

**SEE ALSO**[Cloud-Init Documentation](#)[OpenStack Dashboard](#)[Launch and Manage Instances](#)[Horizon: The OpenStack Dashboard Project](#)**Release History Table**

Release	Description
15.1X49-D130	Starting in Junos OS Release 15.1X49-D130 and Junos OS Release 18.4R1, the cloud-init functionality in vSRX Virtual Firewall has been extended to support the use of a configuration drive data source in an OpenStack environment. The configuration drive uses the user-data attribute to pass a validated Junos OS configuration file to the vSRX Virtual Firewall instance.
15.1X49-D100	Starting in Junos OS Release 15.1X49-D100 and Junos OS Release 17.4R1, the cloud-init package (version 0.7x) comes pre-installed in the vSRX Virtual Firewall image to help simplify configuring new vSRX Virtual Firewall instances operating in an OpenStack environment according to a specified user-data file. Cloud-init is performed during the first-time boot of a vSRX Virtual Firewall instance.

# vSRX Virtual Firewall VM Management with KVM

## IN THIS CHAPTER

- [Configure vSRX Virtual Firewall Using the CLI | 62](#)
- [Connect to the vSRX Virtual Firewall Management Console on KVM | 64](#)
- [Add a Virtual Network to a vSRX Virtual Firewall VM with KVM | 65](#)
- [Add a Virtio Virtual Interface to a vSRX Virtual Firewall VM with KVM | 67](#)
- [SR-IOV and PCI | 69](#)
- [Upgrade a Multi-core vSRX Virtual Firewall | 78](#)
- [Monitor the vSRX Virtual Firewall VM in KVM | 81](#)
- [Manage the vSRX Virtual Firewall Instance on KVM | 82](#)
- [Recover the Root Password for vSRX Virtual Firewall in a KVM Environment | 87](#)

## Configure vSRX Virtual Firewall Using the CLI

To configure the vSRX Virtual Firewall instance using the CLI:

1. Verify that the vSRX Virtual Firewall is powered on.
2. Log in as the root user. There is no password.
3. Start the CLI.

```
root#cli
root@>
```

4. Enter configuration mode.

```
configure
[edit]
root@#
```

5. Set the root authentication password by entering a *cleartext* password, an encrypted password, or an SSH public key string (*DSA* or *RSA*).

```
[edit]
root@# set system root-authentication plain-text-password
New password: password
Retype new password: password
```

6. Configure the hostname.

```
[edit]
root@# set system host-name host-name
```

7. Configure the management interface.

```
[edit]
root@# set interfaces fxp0 unit 0 family inet dhcp-client
```

8. Configure the traffic interfaces.

```
[edit]
root@# set interfaces ge-0/0/0 unit 0 family inet dhcp-client
```

9. Configure basic security zones and bind them to traffic interfaces.

```
[edit]
root@# set security zones security-zone trust interfaces ge-0/0/0.0
```

10. Verify the configuration.

```
[edit]
root@# commit check
configuration check succeeds
```



11. Commit the configuration to activate it on the vSRX Virtual Firewall instance.

```
[edit]
root@# commit
commit complete
```

12. Optionally, use the `show` command to display the configuration to verify that it is correct.

**NOTE:** Certain Junos OS software features require a license to activate the feature. To enable a licensed feature, you need to purchase, install, manage, and verify a license key that corresponds to each licensed feature. To conform to software feature licensing requirements, you must purchase one license per feature per instance. The presence of the appropriate software unlocking key on your virtual instance allows you to configure and use the licensed feature. See [Managing Licenses for vSRX](#) for details.

## RELATED DOCUMENTATION

| [CLI User Guide](#)

## Connect to the vSRX Virtual Firewall Management Console on KVM

Ensure that you have the `virt-manager` package or `virsh` installed on your *host* OS.

To connect to the vSRX Virtual Firewall management console using `virt-manager`:

1. Launch `virt-manager`.
2. Highlight the vSRX Virtual Firewall VM you want to connect to from the list of VMs displayed.
3. Click **Open**.
4. Select **View>Text Consoles>Serial 1**. The vSRX Virtual Firewall console appears.

To connect to the vSRX Virtual Firewall VM with `virsh`:

1. Use the `virsh console` command on the Linux host OS.

```
user@host# virsh console vSRX-kvm-2
```

```
Connected to domain vSRX-kvm-2
```

2. The vSRX Virtual Firewall console appears.

## Add a Virtual Network to a vSRX Virtual Firewall VM with KVM

You can extend an existing vSRX Virtual Firewall *VM* to use additional virtual networks.

To create a *virtual network* with `virt-manager`:

1. Launch `virt-manager` and select **Edit>Connection Details**. The Connection details dialog box appears.
2. Select **Virtual Networks**. The list of existing virtual networks appears.
3. Click **+** to create a new virtual network for the control link. The Create a new virtual network wizard appears.
4. Set the subnet for this virtual network and click **Forward**.
5. Optionally, select **Enable DHCP** and click **Forward**.
6. Select the network type from the list and click **Forward**.
7. Verify the settings and click **Finish** to create the virtual network.

To create a virtual network with `virsh`:

1. Use the `virsh net-define` command on the *host* OS to create an XML file that defines the new virtual network. Include the XML fields described in [Table 12 on page 66](#) to define this network.

**NOTE:** See the official `virsh` documentation for a complete description of available options, including how to configure IPv6 networks.

Table 12: virsh net-define XML Fields

Field	Description
<code>&lt;network&gt;...&lt;/network&gt;</code>	Use this XML wrapper element to define a virtual network.
<code>&lt;name&gt;net-name&lt;/name&gt;</code>	Specify the virtual network name.
<code>&lt;bridge name="bridge-name" /&gt;</code>	Specify the name of the host bridge used for this virtual network.
<code>&lt;forward mode="forward-option" /&gt;</code>	Specify routed or nat. Do not use the <code>&lt;forward&gt;</code> element for isolated mode.
<code>&lt;ip address="ip-address" netmask="net-mask"</code> <code>&lt;dhcp range start="start" end="end" &lt;/dhcp&gt; &lt;/ip&gt;</code>	Specify the IP address and subnet mask used by this virtual network, along with the DHCP address range.

The following example shows a sample XML file that defines a new virtual network.

```
<network>
  <name>mgmt</name>
  <bridge name="vbr1" />
  <forward mode="nat" />
  <ip address="10.10.10.1" netmask="255.255.255.0" >
    <dhcp>
  <range start="10.10.10.2" end="10.10.10.99" />
    </dhcp>
  </ip>
</network>
```

2. Use the `virsh net-start` command in the host OS to start the new virtual network.

```
hostOS# virsh net-start mgmt
```

3. Use the `virsh net-autostart` command in the host OS to automatically start the new virtual network when the host OS boots.

```
hostOS# virsh net-autostart mgmt
```

- Optionally, use the `virsh net-list -all` command in the host OS to verify the new virtual network.

```
HostOS# # virsh net-list --all
Name           State    Autostart  Persistent
-----
mgmt           active   yes        yes
default        active   yes        yes
```

## RELATED DOCUMENTATION

[virt tools](#)

## Add a Virtio Virtual Interface to a vSRX Virtual Firewall VM with KVM

You can add additional *virtio* virtual interfaces to an existing vSRX Virtual Firewall VM with KVM.

To add additional virtio virtual interfaces to a vSRX Virtual Firewall VM using `virt-manager`:

- In `virt-manager`, double-click the vSRX Virtual Firewall VM and select **View>Details**. The vSRX Virtual Firewall Virtual Machine details dialog box appears.
- Click **Add Hardware**. The Add Hardware dialog box appears.
- Select **Network** from the left navigation panel.
- Select the host device or virtual network on which you want this new virtual interface from the Network source list.
- Select **virtio** from the Device model list and click **Finish**.
- From the vSRX Virtual Firewall console, reboot the vSRX Virtual Firewall instance.

```
vsrx# request system reboot.
```

vSRX Virtual Firewall reboots both Junos OS and the vSRX Virtual Firewall guest VM.

**NOTE:** DPDK places a limit of 64 MAC addresses on the Virtio NIC type. When deploying a protocol that generates an additional MAC address, for example VRRP, you must ensure that no more than 64 sub-interfaces are configured per Virtio NIC to avoid traffic loss.

To add additional virtio virtual interfaces to a vSRX Virtual Firewall VM using `virsh`:

1. Use the `virsh attach-interface` command on the host OS with the mandatory options listed in [Table 13 on page 68](#).

**NOTE:** See the official `virsh` documentation for a complete description of available options.

**Table 13: virsh attach-interface Options**

Command Option	Description
<code>--domain <i>name</i></code>	Specify the name of the guest VM.
<code>--type</code>	Specify the host OS connection type as bridge or network.
<code>--source <i>interface</i></code>	Specify the physical or logical interface on the host OS to associate with this vNIC.
<code>--target <i>vnic</i></code>	Specify the name for the new vNIC.
<code>--model</code>	Specify the vNIC model.

The following example creates a new virtio vNIC from the host OS `virbr0` bridge.

```
user@host# virsh attach-interface --domain vsrxVM --type bridge --source virbr0 --target vsrx-
mgmt --model virtio
```

```
Interface attached successfully
```

```
user@host# virsh dumpxml vsrxVM
```

```
<output omitted>
```

```
<interface type='bridge'>
  <mac address='00:00:5e:00:53:e8' />
  <source bridge='virbr0' />
  <target dev='vsrx-mgmt' />
```

```
<model type='virtio' />
<alias name='net1' />
<address type='pci' domain='0x0000' bus='0x00' slot='0x08' function='0x0' />
</interface>
```

2. From the vSRX Virtual Firewall console, reboot the vSRX Virtual Firewall instance.

vsrx# **request system reboot.**

vSRX Virtual Firewall reboots both Junos OS and the vSRX Virtual Firewall guest VM.

## RELATED DOCUMENTATION

| [virt tools](#)

## SR-IOV and PCI

### IN THIS SECTION

- [SR-IOV Overview | 69](#)
- [SR-IOV HA Support with Trust Mode Disabled \(KVM only\) | 70](#)
- [Configure an SR-IOV Interface on KVM | 74](#)

This section includes the following topics on SR-IOV for a vSRX Virtual Firewall instance deployed on KVM:

### SR-IOV Overview

vSRX Virtual Firewall on KVM supports single-root I/O virtualization (*SR-IOV*) interface types. SR-IOV is a standard that allows a single physical NIC to present itself as multiple vNICs, or virtual functions (VFs), that a *virtual machine* (VM) can attach to. SR-IOV combines with other virtualization technologies, such as Intel VT-d, to improve the I/O performance of the VM. SR-IOV allows each VM to have direct access to packets queued up for the VFs attached to the VM. You use SR-IOV when you need I/O performance that approaches that of the physical bare metal interfaces.

In deployments using SR-IOV interfaces, packets are dropped when a MAC address is assigned to a vSRX Virtual Firewall Junos OS interface. This issue occurs because SR-IOV does not allow MAC address changes in either the PF or the VF.

**NOTE:** SR-IOV in KVM does not remap interface numbers. The interface sequence in the vSRX Virtual Firewall VM XML file matches the interface sequence shown in the Junos OS CLI on the vSRX Virtual Firewall instance.

SR-IOV uses two PCI functions:

- Physical Functions (PFs)—Full PCIe devices that include SR-IOV capabilities. Physical Functions are discovered, managed, and configured as normal PCI devices. Physical Functions configure and manage the SR-IOV functionality by assigning Virtual Functions. When SR-IOV is disabled, the host creates a single PF on one physical NIC.
- Virtual Functions (VFs)—Simple PCIe functions that only process I/O. Each Virtual Function is derived from a Physical Function. The number of Virtual Functions a device may have is limited by the device hardware. A single Ethernet port, the Physical Device, may map to many Virtual Functions that can be shared to guests. When SR-IOV is enabled, the host creates a single PF and multiple VFs on one physical NIC. The number of VFs depends on the configuration and driver support.

## SR-IOV HA Support with Trust Mode Disabled (KVM only)

### IN THIS SECTION

- [Understand SR-IOV HA Support with Trust Mode Disabled \(KVM only\) | 70](#)
- [Configure SR-IOV support with Trust Mode Disabled \(KVM only\) | 72](#)
- [Limitations | 73](#)

### Understand SR-IOV HA Support with Trust Mode Disabled (KVM only)

A Redundant Ethernet Interface (RETH) is a virtual interface consisting of equal number of member interfaces from each participating node of an SRX cluster. All logical configurations such as IP address, QoS, zones, and VPNs are bound to this interface. Physical properties are applied to the member or child interfaces. A RETH interface has a virtual MAC address which is calculated using the cluster id. RETH has been implemented as an aggregated interface/LAG in Junos OS. For a LAG, the parent (logical) IFDs MAC address is copied to each of the child interfaces. When you configure the child interface under the RETH interface, the RETH interface's virtual MAC gets overwritten on the **current MAC address** field of

the child physical interface. This also requires the virtual MAC address to be programmed on the corresponding NIC.

Junos OS runs as a VM on vSRX Virtual Firewall. Junos OS does not have direct access to the NIC and only has a virtual NIC access provided by the hypervisor which might be shared with other VMs running on the same host machine. This virtual access comes with certain restrictions such as a special mode called trust mode, which is required to program a virtual MAC address on the NIC. During deployments, providing the trust mode access might not be feasible because of possible security issues. To enable RETH model to work in such environments, MAC rewrite behavior is modified. Instead of copying the parent virtual MAC address to the children, we keep the children's physical MAC address intact and copy the physical MAC address of the child belonging to the active node of the cluster to the *current MAC* of the reth interface. This way, MAC rewrite access is not required when trust mode is disabled.

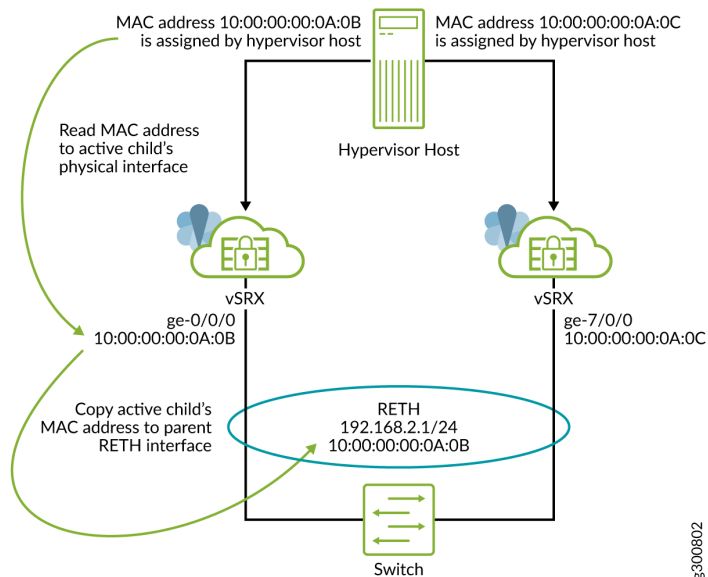
In case of vSRX Virtual Firewall, the DPDK reads the physical MAC address provided by the hypervisor and shares it with the Junos OS control plane. In standalone mode, this physical MAC address is programmed on the physical IFDs. But the support for the same is unavailable in cluster mode, because of which the MAC address for the physical interface is taken from the Juniper reserved MAC pool. In an environment where trust mode is not feasible, the hypervisor is unable to provide the physical MAC address.

To overcome this problem, we have added support to use the hypervisor provided physical MAC address instead of allocating it from the reserved MAC pool. See ["Configure SR-IOV support with Trust Mode Disabled \(KVM only\)" on page 72](#).



## Configure SR-IOV support with Trust Mode Disabled (KVM only)

Figure 11: Copying MAC address from active child interface to parent RETH



Starting in Junos OS Release 19.4R1, SR-IOV HA is supported with trust mode disabled. You can enable this mode by configuring the `use-active-child-mac-on-reth` and `use-actual-mac-on-physical-interfaces` configuration statements at the `[edit chassis cluster]` hierarchy level. If you configure commands in a cluster, the hypervisor assigns the child physical interface's MAC address and the parent RETH interface's MAC address is overwritten by the active child physical interface's MAC address

**NOTE:** You can configure SR-IOV with trust mode disabled, only if the revenue interfaces are SR-IOV. The fabric interfaces or links cannot use SR-IOV with trust mode disabled when the actual MAC physical interfaces are configured.

Using SRIOV with trust mode disabled is supported if only the revenue interfaces are SR-IOV.

You need to reboot the vSRX Virtual Firewall instance to enable this mode. Both the nodes in the cluster need to be rebooted for the commands to take effect.

You need to configure the commands `use-active-child-mac-on-reth` and `use-actual-mac-on-physical-interfaces` together to enable this feature.

## SEE ALSO

[use-active-child-mac-on-reth](#)

[use-actual-mac-on-physical-interfaces](#)

## Limitations

SR-IOV HA support with trust mode disabled on KVM has the following limitations:

- SR-IOV HA support with trust mode disabled is only supported on KVM based systems.
- A reth interface can have maximum one port as a member on each vSRX Virtual Firewall cluster node.
- You cannot use `security nat proxy-arp` feature for NAT pools because no G-ARP is sent out on failover for the IP addresses in NAT pools. Instead, one can set the routes to the NAT pool range in the upstream router to point to the vSRX Virtual Firewall reth interface's IP address as the next-hop. Or, if directly connected hosts need to access the NAT pool addresses, these NAT pool addresses can be configured for proxy ARP under the reth interface.
- If the reth interface is configured with many VLANs, it might take some time to send all the G-ARPs on a failover. This might lead to a noticeable interruption in traffic.
- A dataplane failover will result in a change of the MAC address of the reth interface. Therefore the failover is not transparent to directly connected neighboring Layer 3 devices (routers or servers). The vSRX Virtual Firewall reth IP address must be mapped to a new MAC address in the ARP table on the neighboring devices. vSRX Virtual Firewall will send out a G-ARP which will help these devices. In case these neighboring devices do not act on the G-ARP received from the vSRX Virtual Firewall or show a slow response, the traffic might be interrupted until that device updates its ARP table correctly.
- The following vSRX Virtual Firewall features are not supported in deployments that use SR-IOV interfaces:

These limitations apply in deployments where the PF drivers cannot be updated or controlled. The limitations do not apply when vSRX Virtual Firewall is deployed on supported Juniper Networks devices.

- High availability (HA)
- IRB interfaces
- IPv6 addressing
- Jumbo frames
- Layer 2 support

- Multicast with other features such as OSPF and IPv6
- Packet mode

## Configure an SR-IOV Interface on KVM

If you have a physical NIC that supports SR-IOV, you can attach SR-IOV-enabled vNICs or virtual functions (VFs) to the vSRX Virtual Firewall instance to improve performance. We recommend that if you use SR-IOV, all revenue ports are configured as SR-IOV.

Note the following about SR-IOV support for vSRX Virtual Firewall on KVM:

- Starting in Junos OS Release 15.1X49-D90 and Junos OS Release 17.3R1, a vSRX Virtual Firewall instance deployed on KVM supports SR-IOV on an Intel X710/XL710 NIC in addition to Intel 82599 or X520/540.
- Starting in Junos OS Release 18.1R1, a vSRX Virtual Firewall instance deployed on KVM supports SR-IOV on the Mellanox ConnectX-3 and ConnectX-4 Family Adapters.

**NOTE:** See the *vSRX Virtual Firewall Performance Scale Up* discussion in *Understand vSRX with KVM* for the vSRX Virtual Firewall scale up performance when deployed on KVM, based on vNIC and the number of vCPUs and vRAM applied to a vSRX Virtual Firewall VM.

Before you can attach an SR-IOV enabled VF to the vSRX Virtual Firewall instance, you must complete the following tasks:

- Insert an SR-IOV-capable physical network adapter in the host server.
- Enable the Intel VT-d CPU virtualization extensions in BIOS on your host server. The Intel VT-d extensions provides hardware support for directly assigning a physical devices to guest. Verify the process with the vendor because different systems have different methods to enable VT-d.
- Ensure that SR-IOV is enabled at the system/server BIOS level by going into the BIOS settings during the host server boot-up sequence to confirm the SR-IOV setting. Different server manufacturers have different naming conventions for the BIOS parameter used to enable SR-IOV at the BIOS level. For example, for a Dell server ensure that the **SR-IOV Global Enable** option is set to **Enabled**.

**NOTE:** We recommend that you use `virt-manager` to configure SR-IOV interfaces. See the `virsh attach-device` command documentation if you want to learn how to add a PCI host device to a VM with the `virsh` CLI commands.

Also, you must configure the interfaces in the order of 1G, 10G, 40G, and 100G. If this order is not followed, then you need to reset the network adaptors.

To add an SR-IOV VF to a vSRX Virtual Firewall VM using the virt-manager graphical interface:

1. In the Junos OS CLI, shut down the vSRX Virtual Firewall VM if it is running.

```
vsrx> request system power-off
```

2. In virt-manager, double-click the vSRX Virtual Firewall VM and select **View>Details**. The vSRX Virtual Firewall Virtual Machine details dialog box appears.
3. Select the Hardware tab, then click **Add Hardware**. The Add Hardware dialog box appears.
4. Select **PCI Host Device** from the Hardware list on the left.
5. Select the SR-IOV VF for this new virtual interface from the host device list.
6. Click **Finish** to add the new device. The setup is complete and the vSRX Virtual Firewall VM now has direct access to the device.
7. From the virt-manager icon bar at the upper-left side of the window, click the Power On arrow. The vSRX Virtual Firewall VM starts. Once the vSRX Virtual Firewall is powered on the Running status will display in the window.

You can connect to the management console to watch the boot-up sequence.

**NOTE:** After the boot starts, you need to select **View>Text Consoles>Serial 1** in virt-manager to connect to the vSRX Virtual Firewall console.

To add an SR-IOV VF to a vSRX Virtual Firewall VM using virsh CLI commands:

1. Define four virtual functions for eno2 interface, update the sriov\_numvfs file with number 4.

```
root@LabHost:~# echo 4 > /sys/class/net/eno2/device/sriov_numvfs
root@LabHost:~# more /sys/class/net/eno2/device/sriov_numvfs
```

2. Identify the device.

Identify the PCI device designated for device assignment to the virtual machine. Use the `lspci` command to list the available PCI devices. You can refine the output of `lspci` with `grep`.

Use command **lspci** to check the VF number according to the VF ID.

```
root@ kvmsrv:~# lspci | grep Ether
```

```
.....
83:00.0 Ethernet controller: Intel Corporation Ethernet Controller XL710 for 40GbE QSFP+ (rev 02) - Physical Function
83:00.1 Ethernet controller: Intel Corporation Ethernet Controller XL710 for 40GbE QSFP+ (rev 02) - Physical Function
83:02.0 Ethernet controller: Intel Corporation Ethernet Virtual Function 700 Series (rev 02)
83:02.1 Ethernet controller: Intel Corporation Ethernet Virtual Function 700 Series (rev 02)
83:02.2 Ethernet controller: Intel Corporation Ethernet Virtual Function 700 Series (rev 02)
83:02.3 Ethernet controller: Intel Corporation Ethernet Virtual Function 700 Series (rev 02)
83:02.4 Ethernet controller: Intel Corporation Ethernet Virtual Function 700 Series (rev 02)
83:02.5 Ethernet controller: Intel Corporation Ethernet Virtual Function 700 Series (rev 02)
83:02.6 Ethernet controller: Intel Corporation Ethernet Virtual Function 700 Series (rev 02)
83:02.7 Ethernet controller: Intel Corporation Ethernet Virtual Function 700 Series (rev 02)
83:0a.0 Ethernet controller: Intel Corporation Ethernet Virtual Function 700 Series (rev 02)
83:0a.1 Ethernet controller: Intel Corporation Ethernet Virtual Function 700 Series (rev 02)
83:0a.2 Ethernet controller: Intel Corporation Ethernet Virtual Function 700 Series (rev 02)
83:0a.3 Ethernet controller: Intel Corporation Ethernet Virtual Function 700 Series (rev 02)
83:0a.4 Ethernet controller: Intel Corporation Ethernet Virtual Function 700 Series (rev 02)
83:0a.5 Ethernet controller: Intel Corporation Ethernet Virtual Function 700 Series (rev 02)
83:0a.6 Ethernet controller: Intel Corporation Ethernet Virtual Function 700 Series (rev 02)
83:0a.7 Ethernet controller: Intel Corporation Ethernet Virtual Function 700 Series (rev 02)
.....
```

3. Add SR-IOV device assignment from a vSRX Virtual Firewall XML profile on KVM and review device information.

The driver could use either `vfio` or `kvm`, depends on KVM server OS/kernel version and drivers for virtualization support. The address type references the unique PCI slot number for each SR-IOV VF (Virtual Function).

Information on the domain, bus, and function are available from output of the `virsh nodedev-dumpxml` command.

```
<interface type="hostdev" managed="yes">
<driver name="vfio"/>
<source>
```

```
<address type="pci" domain="0x0000" bus="0x83" slot="0x02" function="0x3"/>
</source>
<address type="pci" domain="0x0000" bus="0x00" slot="0x05" function="0x0"/>
</interface>
```

4. Add PCI device in edit setting and select VF according to the VF number.

**NOTE:** This operation should be done when VM is powered off. Also, do not clone VMs with PCI devices which might lead to VF or MAC conflict.

5. Start the VM using the # `virsh start name of virtual machine` command.

### Release History Table

Release	Description
18.1R1	Starting in Junos OS Release 18.1R1, a vSRX Virtual Firewall instance deployed on KVM supports SR-IOV on the Mellanox ConnectX-3 and ConnectX-4 Family Adapters.
15.1X49-D90	Starting in Junos OS Release 15.1X49-D90 and Junos OS Release 17.3R1, a vSRX Virtual Firewall instance deployed on KVM supports SR-IOV on an Intel X710/XL710 NIC in addition to Intel 82599 or X520/540.

### RELATED DOCUMENTATION

[Requirements for vSRX Virtual Firewall on KVM | 7](#)

[Intel SR-IOV Explanation](#)

[PCI-SIG SR-IOV Primer](#)

[SR-IOV](#)

[Intel - SR-IOV Configuration Guide](#)

[Red Hat - SR-IOV - PCI Devices](#)

## Upgrade a Multi-core vSRX Virtual Firewall

### IN THIS SECTION

- [Configure the Queue Value for vSRX Virtual Firewall VM with KVM | 78](#)
- [Shutdown the vSRX Virtual Firewall Instance with virt-manager | 79](#)
- [Upgrade vSRX Virtual Firewall with virt-manager | 79](#)

Starting in Junos OS Release 15.1X49-D70 and Junos OS Release 17.3R1, you can use `virt-manager` to scale the performance and capacity of a vSRX Virtual Firewall instance by increasing the number of vCPUs or the amount of vRAM allocated to the vSRX Virtual Firewall. See *Requirements for vSRX on KVM* for the software requirement specifications for a vSRX Virtual Firewall VM.

See your *host* OS documentation for complete details on the `virt-manager` package

**NOTE:** You cannot scale down the number of vCPUs or decrease the amount of vRAM for an existing vSRX Virtual Firewall VM.

### Configure the Queue Value for vSRX Virtual Firewall VM with KVM

Before you plan to scale up vSRX Virtual Firewall performance, modify the vSRX Virtual Firewall VM XML file to configure network multi-queuing as a means to support an increased number of dataplane vCPUs for the vSRX Virtual Firewall VM. This setting updates the libvirt driver to enable multi-queue virtio-net so that network performance can scale as the number of dataplane vCPUs increases. Multi-queue virtio is an approach that enables the processing of packet sending and receiving to be scaled to the number of available virtual CPUs (vCPUs) of a guest, through the use of multiple queues.

The configuration of multi-queue virtio-net, however, can only be performed in the XML file. OpenStack does not support multi-queue.

To update the queue, at the `<driver name='vhost' queues='x' />` line in the vSRX Virtual Firewall VM XML file, match the number of queues with number of dataplane vCPUs you plan to configure for the vSRX Virtual Firewall VM. The default is 4 dataplane vCPUs, but you can scale that number to 4, 8, or 16 vCPUs.

The following XML file example configures 8 queues for a vSRX Virtual Firewall VM with 8 dataplane vCPUs:

```
<output omitted>

<interface type='network'>
  <source network='net2' />
  <model type='virtio' />
  <driver name='vhost' queues='8' />
  <address type='pci' domain='0x0000' bus='0x00' slot='0x04' function='0x0' />
</interface>
```

### Shutdown the vSRX Virtual Firewall Instance with virt-manager

In situations where you want to edit and modify the vSRX Virtual Firewall VM XML file, you need to completely shut down vSRX Virtual Firewall and the associated VM.

To gracefully shutdown the vSRX Virtual Firewall instance with `virt-manager`:

1. Launch `virt-manager`.
2. Check the vSRX Virtual Firewall instance you want to power off.
3. Select **Open** to open a console window to the vSRX Virtual Firewall instance.
4. From the vSRX Virtual Firewall console, reboot the vSRX Virtual Firewall instance.  
`vsrx# request system power-off.`
5. From `virt-manager`, select **Shut Down** to completely shutdown the VM so you can edit the XML file.

**NOTE:** Do not use **Force Reset** or **Force Off** on any active VM as it may create file corruptions.

### Upgrade vSRX Virtual Firewall with virt-manager

You must shut down the vSRX Virtual Firewall VM before you can update vCPU or vRAM values for the VM.

You can upgrade and launch vSRX Virtual Firewall with the *KVM* `virt-manager` GUI package.

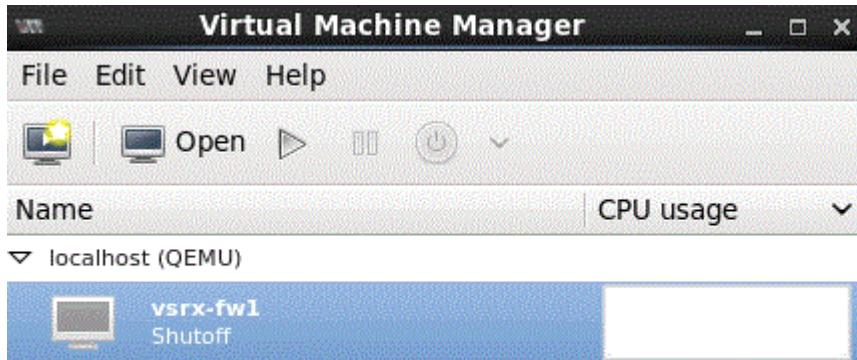
To scale up a vSRX Virtual Firewall VM with `virt-manager` to a higher number of vCPUs or to an increased amount of vRAM:

1. On your host OS, type **virt-manager**. The Virtual Machine Manager appears. See [Figure 12 on page 80](#).



**NOTE:** You must have admin rights on the host OS to use `virt-manager`.

Figure 12: virt-manager



2. Select **Open** to open the powered down vSRX Virtual Firewall VM and select **Edit Hardware Details** to open the virtual machine details window.
3. Select **Processor** and set the number of vCPUs. Click **Apply**.
4. Select **Memory** and set the vRAM to the desired size. Click **Apply**.
5. Click **Power On**. The VM manager launches the vSRX Virtual Firewall VM with the new vCPU and vRAM settings.

**NOTE:** vSRX Virtual Firewall scales down to the closest supported value if the vCPU or vRAM settings do not match what is currently available.

#### Release History Table

Release	Description
15.1X49-D70	Starting in Junos OS Release 15.1X49-D70 and Junos OS Release 17.3R1, you can use <code>virt-manager</code> to scale the performance and capacity of a vSRX Virtual Firewall instance by increasing the number of vCPUs or the amount of vRAM allocated to the vSRX Virtual Firewall

#### RELATED DOCUMENTATION

[Understand vSRX Virtual Firewall with KVM | 2](#)

## Monitor the vSRX Virtual Firewall VM in KVM

You can monitor the overall state of the vSRX Virtual Firewall VM with `virt-manager` or `virsh`.

To monitor the vSRX Virtual Firewall VM with `virt-manager`:

1. From the `virt-manager` GUI, select the vSRX Virtual Firewall VM you want to monitor.
2. Select **View>Graph** and select the statistics you want to monitor. Options include CPU, memory, disk I/O, and network interface statistics.

The window updates with thumbnail graphs for the statistics you selected.

3. Optionally, double-click on the thumbnail graph to expand the view.

To monitor the vSRX Virtual Firewall VM with `virsh`, use the commands listed in [Table 14 on page 81](#).

**Table 14: virsh Monitor Commands**

Command	Description
<code>virsh cpu-stats <i>vm-name</i></code>	Lists the CPU statistics for the VM.
<code>virsh domifstat <i>vm-name interface-name</i></code>	Displays the vNIC statistics for the VM.
<code>virsh dommemstat <i>vm-name</i></code>	Displays memory statistics for the VM.
<code>virsh vcpuinfo <i>vm-name</i></code>	Displays vCPU details for the VM.
<code>virsh nodecpustats</code>	Displays CPU statistics for the host OS.

### RELATED DOCUMENTATION

[virt tools](#)

## Manage the vSRX Virtual Firewall Instance on KVM

### IN THIS SECTION

- Power On the vSRX Virtual Firewall Instance with `virt-manager` | 82
- Power On the vSRX Virtual Firewall Instance with `virsh` | 82
- Pause the vSRX Virtual Firewall Instance with `virt-manager` | 83
- Pause the vSRX Virtual Firewall Instance with `virsh` | 83
- Rebooting the vSRX Virtual Firewall Instance with `virt-manager` | 83
- Reboot the vSRX Virtual Firewall Instance with `virsh` | 83
- Power Off the vSRX Virtual Firewall Instance with `virt-manager` | 84
- Power Off the vSRX Virtual Firewall Instance with `virsh` | 84
- Shutdown the vSRX Virtual Firewall Instance with `virt-manager` | 85
- Shutdown the vSRX Virtual Firewall Instance with `virsh` | 85
- Remove the vSRX Virtual Firewall Instance with `virsh` | 86

Each vSRX Virtual Firewall instance is an independent *VM* that you can power on, pause, or shut down. You can manage the vSRX Virtual Firewall VM with multiple tools, including `virt-manager` and `virsh`.

### Power On the vSRX Virtual Firewall Instance with `virt-manager`

To power on the vSRX Virtual Firewall instance with `virt-manager`:

1. Launch `virt-manager`.
2. Check the vSRX Virtual Firewall instance you want to power on.
3. From the icon bar, select the power on arrow. The vSRX Virtual Firewall VM starts. You can connect to the management console to watch the boot-up sequence.

**NOTE:** After the boot starts, you need to select **View>Text Consoles>Serial 1** in `virt-manager` to connect to the vSRX Virtual Firewall console.

### Power On the vSRX Virtual Firewall Instance with `virsh`

To power on the vSRX Virtual Firewall instance with `virsh`:

Use the `virsh start` command on the *host* OS to start a vSRX Virtual Firewall VM.

```
user@host# virsh start vSRX-kvm-2
```

```
Domain vSRX-kvm-2 started
```

## Pause the vSRX Virtual Firewall Instance with virt-manager

To pause the vSRX Virtual Firewall instance with `virt-manager`:

1. Launch `virt-manager`.
2. Check the vSRX Virtual Firewall instance you want to pause.
3. From the icon bar, select the power on pause icon. The vSRX Virtual Firewall VM pauses.

## Pause the vSRX Virtual Firewall Instance with virsh

To pause the vSRX Virtual Firewall instance with `virsh`:

Use the `virsh suspend` command on the host OS to pause a vSRX Virtual Firewall VM.

```
user@host# virsh suspend vSRX-kvm-2
```

```
Domain vSRX-kvm-2 suspended
```

## Rebooting the vSRX Virtual Firewall Instance with virt-manager

To reboot the vSRX Virtual Firewall instance with `virt-manager`:

1. Launch `virt-manager`.
2. Check the vSRX Virtual Firewall instance you want to reboot.
3. Select **Open** to open a console window to the vSRX Virtual Firewall instance.
4. From the vSRX Virtual Firewall console, reboot the vSRX Virtual Firewall instance.

```
vsrx# request system reboot.
```

vSRX Virtual Firewall reboots both Junos OS and the vSRX Virtual Firewall guest VM.

## Reboot the vSRX Virtual Firewall Instance with virsh

To reboot the vSRX Virtual Firewall VM with `virsh`:

1. Use the `virsh console` command on the host OS to connect to the vSRX Virtual Firewall VM.
2. On the vSRX Virtual Firewall console, use the `request system reboot` command to reboot Junos OS and the vSRX Virtual Firewall VM.

```
user@host# virsh console vSRX-kvm-2
```

```
Connected to domain vSRX-kvm-2
```

```
vsrx# request system reboot
```

### Power Off the vSRX Virtual Firewall Instance with `virt-manager`

To power off the vSRX Virtual Firewall instance with `virt-manager`:

1. Launch `virt-manager`.
2. Check the vSRX Virtual Firewall instance you want to power off.
3. Select **Open** to open a console window to the vSRX Virtual Firewall instance.
4. From the vSRX Virtual Firewall console, power off the vSRX Virtual Firewall instance.

```
vsrx> request system power-off
```

vSRX Virtual Firewall powers off both Junos OS and the guest VM.

### Power Off the vSRX Virtual Firewall Instance with `virsh`

To power off the vSRX Virtual Firewall instance with `virsh`:

1. Use the `virsh console` command on the host OS to connect to the vSRX Virtual Firewall VM.

2. On the vSRX Virtual Firewall console, use the `request system power-off` command to power off Junos OS and the vSRX Virtual Firewall VM.

```
user@host# virsh console vSRX-kvm-2
```

```
Connected to domain vSRX-kvm-2
```

```
vsrx# request system power-off
```

## Shutdown the vSRX Virtual Firewall Instance with virt-manager

In situations where you want to edit and modify the vSRX Virtual Firewall VM XML file, you need to completely shut down vSRX Virtual Firewall and the associated VM.

To gracefully shutdown the vSRX Virtual Firewall instance with `virt-manager`:

1. Launch `virt-manager`.
2. Check the vSRX Virtual Firewall instance you want to power off.
3. Select **Open** to open a console window to the vSRX Virtual Firewall instance.
4. From the vSRX Virtual Firewall console, reboot the vSRX Virtual Firewall instance.  
`vsrx# request system power-off.`
5. From `virt-manager`, select **Shut Down** to completely shutdown the VM so you can edit the XML file.

**NOTE:** Do not use **Force Reset** or **Force Off** on any active VM as it may create file corruptions.

## Shutdown the vSRX Virtual Firewall Instance with virsh

In situations where you want to modify the vSRX Virtual Firewall VM XML file, you need to completely shut down vSRX Virtual Firewall and the associated VM.

To gracefully shutdown the vSRX Virtual Firewall instance with `virsh`:

1. Use the `virsh console` command on the host OS to connect to the vSRX Virtual Firewall VM.
2. On the vSRX Virtual Firewall console, use the `request system power-off` command to power off Junos OS and the vSRX Virtual Firewall VM.

3. On the host OS, use the `virsh shutdown` command to shut down the VM after vSRX Virtual Firewall has powered off.

```
user@host# virsh console vSRX-kvm-2
```

```
Connected to domain vSRX-kvm-2
```

```
vsrx# request system power-off  
user@host# virsh shutdown vSRX-kvm-2
```

**NOTE:** Do not use the `virsh destroy` command on any active VM as it may create file corruptions.

## Remove the vSRX Virtual Firewall Instance with `virsh`

In situations where you want to completely remove the vSRX Virtual Firewall instance, you need to destroy the vSRX Virtual Firewall VM and undefine the associated XML file.

To completely remove the vSRX Virtual Firewall instance with `virsh`:

1. On the host OS, use the `virsh destroy` command to destroy the vSRX Virtual Firewall VM.
2. On the host OS, use the `virsh undefine` command to undefine the vSRX Virtual Firewall XML file.

```
user@host# virsh destroy vSRX-kvm-2  
user@host# virsh undefine vSRX-kvm-2
```

## RELATED DOCUMENTATION

| [virt tools](#)

## Recover the Root Password for vSRX Virtual Firewall in a KVM Environment

If you forget the root password for a vSRX Virtual Firewall instance deployed in a KVM environment, use this password recovery procedure to reset the root password. (KB article 31790).

**NOTE:** You need console access to recover the root password

To recover the root password for a vSRX Virtual Firewall instance:

1. Reboot the vSRX Virtual Firewall instance by entering the `virsh reboot` command, specifying either *domain-id* or *domain-name*.
2. Immediately attempt to login to the vSRX Virtual Firewall instance by entering the `virsh console domain-name` command to access the vSRX Virtual Firewall console.

**NOTE:** We recommend that you specify *domain-name* when attempting the vSRX Virtual Firewall instance login. It is possible that *domain-id* might change after the vSRX Virtual Firewall instance reboot.

3. After login you will see a prompt similar to `Escape character is ^].` Press **Enter** two or three times until the boot process begins. Continue with the boot process until you see the following prompt:

```
Hit [Enter] to boot immediately, or space bar for command prompt. Booting [kernel] in 9 seconds...
```

4. Press the space bar two or three times to stop the boot sequence, and then enter `boot -s` to login to single-user mode.
5. Enter `recovery` to start the root password recovery procedure.

```
Enter full pathname of shell or 'recovery' for root password recovery or RETURN for /bin/sh: recovery
```

Once the script terminates you will be in vSRX Virtual Firewall operational mode.

6. Enter configuration mode in the CLI.



7. Set the root password.

```
[edit]
user@host# set system root-authentication plain-text-password
```

8. Enter the new root password.

```
New password: xxxxxxxx
Retype new password:
```

9. At the second prompt, reenter the new root password.
10. If you are finished configuring the new root password for the vSRX Virtual Firewall instance, commit the configuration.

```
root@host# commit
commit complete
```

11. Exit from configuration mode.
12. Exit from operational mode.
13. Enter *y* to reboot the device.

```
Reboot the system? [y/n] y
```

The start up messages display on the screen.

14. Once again, press the space bar two or three times to access the bootstrap loader prompt.
15. The vSRX Virtual Firewall instance starts up again and prompts you to enter a user name and password. Enter the newly configured password.

```
login: root
Password: xxxxxxxx
```

# Configure vSRX Virtual Firewall Chassis Clusters on KVM

## IN THIS CHAPTER

- vSRX Virtual Firewall Cluster Staging and Provisioning for KVM | 89
- Configure a vSRX Virtual Firewall Chassis Cluster in Junos OS | 94
- Verify the Chassis Cluster Configuration | 105

## vSRX Virtual Firewall Cluster Staging and Provisioning for KVM

### IN THIS SECTION

- Chassis Cluster Provisioning on vSRX Virtual Firewall | 89
- Creating the Chassis Cluster Virtual Networks with virt-manager | 91
- Creating the Chassis Cluster Virtual Networks with virsh | 91
- Configuring the Control and Fabric Interfaces with virt-manager | 93
- Configuring the Control and Fabric Interfaces with virsh | 93
- Configuring Chassis Cluster Fabric Ports | 93

You can provision the vSRX Virtual Firewall VMs and virtual networks to configure chassis clustering.

The staging and provisioning of the vSRX Virtual Firewall *chassis cluster* includes the following tasks:

### Chassis Cluster Provisioning on vSRX Virtual Firewall

Chassis cluster requires the following direct connections between the two vSRX Virtual Firewall instances:

- Control link, or *virtual network*, which acts in active/passive mode for the control plane traffic between the two vSRX Virtual Firewall instances
- Fabric link, or virtual network, which acts in active/active mode for the data traffic between the two vSRX Virtual Firewall instances

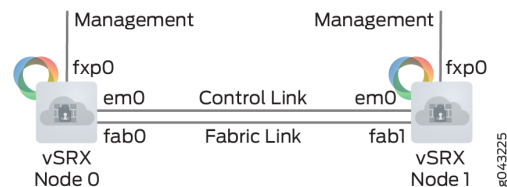
**NOTE:** You can optionally create two fabric links for more redundancy.

The vSRX Virtual Firewall cluster uses the following interfaces:

- Out-of-band Management interface (fxp0)
- Cluster control interface (em0)
- Cluster fabric interface (fab0 on node0, fab1 on node1)

**NOTE:** The control interface must be the second *vNIC*. You can optionally configure a second fabric link for increased redundancy.

**Figure 13: vSRX Virtual Firewall Chassis Cluster**



vSRX Virtual Firewall supports chassis cluster using the virtio driver and interfaces, with the following considerations:

- When you enable chassis cluster, you must also enable jumbo frames (MTU size = 9000) to support the fabric link on the virtio network interface.
- If you configure a chassis cluster across two physical hosts, disable igmp-snooping on each host physical interface that the vSRX Virtual Firewall control link uses to ensure that the control link heartbeat is received by both nodes in the chassis cluster.

```
host0S# echo 0 > /sys/devices/virtual/net/<bridge-name>/bridge/multicast_snooping
```

- After you enable chassis cluster, the vSRX Virtual Firewall instance maps the second vNIC to the control link, em0. You can map any other vNICs to the fabric link.

**NOTE:** For virtio interfaces, link status update is not supported. The link status of virtio interfaces is always reported as Up. For this reason, a vSRX Virtual Firewall instance using virtio and chassis cluster cannot receive link up and link down messages from virtio interfaces. The virtual network MAC aging time determines the amount of time that an entry remains in the MAC table. We recommend that you reduce the MAC aging time on the virtual networks to minimize the downtime during failover.

For example, you can use the `brctl setageing bridge 1` command to set aging to 1 second for the Linux bridge.

You configure the virtual networks for the control and fabric links, then create and connect the control interface to the control virtual network and the fabric interface to the fabric virtual network.

### Creating the Chassis Cluster Virtual Networks with virt-manager

In KVM, you create two virtual networks (control and fabric) to which you can connect each vSRX Virtual Firewall instance for chassis clustering.

To create a virtual network with virt-manager:

1. Launch `virt-manager` and select **Edit>Connection Details**. The Connection details dialog box appears.
2. Select **Virtual Networks**. The list of existing virtual networks appears.
3. Click **+** to create a new virtual network for the control link. The Create a new virtual network wizard appears.
4. Set the subnet for this virtual network and click **Forward**.
5. Select **Enable DHCP** and click **Forward**.
6. Select **Isolated virtual network** and click **forward**.
7. Verify the settings and click **Finish** to create the virtual network.

### Creating the Chassis Cluster Virtual Networks with virsh

In KVM, you create two virtual networks (control and fabric) to which you can connect each vSRX Virtual Firewall for chassis clustering.

To create the control network with virsh:

1. Use the `virsh net-define` command on the *host* OS to create an XML file that defines the new virtual network. Include the XML fields described in [Table 15 on page 92](#) to define this network.

**NOTE:** See the official `virsh` documentation for a complete description of available options.

**Table 15: `virsh net-define` XML Fields**

Field	Description
<code>&lt;network&gt;...&lt;/network&gt;</code>	Use this XML wrapper element to define a virtual network.
<code>&lt;name&gt;net-name&lt;/name&gt;</code>	Specify the virtual network name.
<code>&lt;bridge name="bridge-name" /&gt;</code>	Specify the name of the host bridge used for this virtual network.
<code>&lt;forward mode="forward-option" /&gt;</code>	Specify routed or nat. Do not use the <code>&lt;forward&gt;</code> element for isolated mode.
<code>&lt;ip address="ip-address" netmask="net-mask"</code> <code>&lt;dhcp range start="start" end="end" &lt;/dhcp&gt; &lt;/ip&gt;</code>	Specify the IP address and subnet mask used by this virtual network, along with the DHCP address range.

The following example shows a sample XML file that defines a control virtual network.

```
<network>
  <name>control</name>
  <bridge name="controlvbr0" />
  <ip address="10.10.10.1" netmask="255.255.255.0" >
    <dhcp>
      <range start="10.10.10.2" end="10.10.10.99" />
    </dhcp>
  </ip>
</network>
```

- Use the `virsh net-start` command to start the new virtual network.  
 hostOS# **virsh net-start control**
- Use the `virsh net-autostart` command to automatically start the new virtual network when the host OS boots.

hostOS# **virsh net-autostart control**

- Optionally, use the `virsh net-list -all` command in the host OS to verify the new virtual network.

```
hostOS# # virsh net-list --all
Name                State    Autostart  Persistent
-----
control             active   yes        yes
default             active   yes        yes
```

- Repeat this procedure to create the fabric virtual network.

## Configuring the Control and Fabric Interfaces with virt-manager

To configure the control and fabric interfaces for chassis clustering with `virt-manager`:

- In `virt-manager`, double-click the vSRX Virtual Firewall VM and select **View>Details**. The vSRX Virtual Firewall Virtual Machine details dialog box appears.
- Select the second *vNIC* and select the control *virtual network* from the Source device list.
- Select **virtio** from the Device model list and click **Apply**.
- Select a subsequent vNIC, and select the fabric virtual network from the Source device list.
- Select **virtio** from the Device model list and click **Apply**.
- For the fabric interface, use the `ifconfig` command on the host OS to set the MTU to 9000.

```
hostOS# ifconfig vnet1 mtu 9000
```

## Configuring the Control and Fabric Interfaces with virsh

To configure control and fabric interfaces to a vSRX Virtual Firewall VM with `virsh`:

- Type `virsh attach-interface --domain vsrx-vm-name --type network --source control-vnetwork --target control --model virtio` on the host OS.  
This command creates a virtual interface called control and connects it to the control virtual network.
- Type `virsh attach-interface --domain vsrx-vm-name --type network --source fabric-vnetwork --target fabric --model virtio` on the host OS.  
This command creates a virtual interface called fabric and connects it to the fabric virtual network.
- For the fabric interface, use the `ifconfig` command on the host OS to set the MTU to 9000.

```
hostOS# ifconfig vnet1 mtu 9000
```

## Configuring Chassis Cluster Fabric Ports

After the chassis cluster is formed, you must configure the interfaces that make up the fabric (data) ports.

Ensure that you have configured the following:

- Set the chassis cluster IDs on both vSRX Virtual Firewall instances and rebooted the vSRX Virtual Firewall instances.
  - Configured the control and fabric links.
1. On the vSRX Virtual Firewall node 0 console in configuration mode, configure the fabric (data) ports of the cluster that are used to pass real-time objects (RTOs). The configuration will be synchronized directly through the control port to vSRX Virtual Firewall node 1.

**NOTE:** A fabric port can be any unused revenue interface.

```
user@vsrx0# set interfaces fab0 fabric-options member-interfaces ge-0/0/0
user@vsrx0# set interfaces fab1 fabric-options member-interfaces ge-7/0/0
user@vsrx0# set chassis cluster reth-count 2
user@vsrx0# set chassis cluster redundancy-group 0 node 0 priority 100
user@vsrx0# set chassis cluster redundancy-group 0 node 1 priority 10
user@vsrx0# set chassis cluster redundancy-group 1 node 0 priority 100
user@vsrx0# set chassis cluster redundancy-group 1 node 1 priority 10
user@vsrx0# commit
```

2. Reboot vSRX Virtual Firewall node 0.

## RELATED DOCUMENTATION

| [virt tools](#)

## Configure a vSRX Virtual Firewall Chassis Cluster in Junos OS

### IN THIS SECTION

- [Chassis Cluster Overview | 95](#)
- [Enable Chassis Cluster Formation | 96](#)
- [Chassis Cluster Quick Setup with J-Web | 97](#)

## Chassis Cluster Overview

*Chassis cluster* groups a pair of the same kind of vSRX Virtual Firewall instances into a cluster to provide network node redundancy. The vSRX Virtual Firewall instances in a chassis cluster must be running the same Junos OS release, and each instance becomes a node in the chassis cluster. You connect the control virtual interfaces on the respective nodes to form a *control plane* that synchronizes the configuration and Junos OS kernel state on both nodes in the cluster. The control link (a *virtual network* or *vSwitch*) facilitates the redundancy of interfaces and services. Similarly, you connect the *data plane* on the respective nodes over the fabric virtual interfaces to form a unified data plane. The fabric link (a virtual network or vSwitch) allows for the management of cross-node flow processing and for the management of session redundancy.

The control plane software operates in active/passive mode. When configured as a chassis cluster, one node acts as the primary and the other as the secondary to ensure stateful failover of processes and services in the event of a system or hardware failure on the primary. If the primary fails, the secondary takes over processing of control plane traffic.

**NOTE:** If you configure a chassis cluster across two hosts, disable igmp-snooping on the bridge that each host physical interface belongs to and that the control virtual NICs (vNICs) use. This ensures that the control link heartbeat is received by both nodes in the chassis cluster.

The chassis cluster data plane operates in active/active mode. In a chassis cluster, the data plane updates session information as traffic traverses either node, and it transmits information between the nodes over the fabric link to guarantee that established sessions are not dropped when a failover occurs. In active/active mode, traffic can enter the cluster on one node and exit from the other node.

Chassis cluster functionality includes:

- Resilient system architecture, with a single active control plane for the entire cluster and multiple *Packet Forwarding Engines*. This architecture presents a single device view of the cluster.
- Synchronization of configuration and dynamic runtime states between nodes within a cluster.
- Monitoring of physical interfaces, and failover if the failure parameters cross a configured threshold.
- Support for generic routing encapsulation (*GRE*) and IP-over-IP (IP-IP) tunnels used to route encapsulated IPv4 or *IPv6* traffic by means of two internal interfaces, *gr-0/0/0* and *ip-0/0/0*, respectively. Junos OS creates these interfaces at system startup and uses these interfaces only for processing GRE and IP-IP tunnels.



At any given instant, a cluster node can be in one of the following states: hold, primary, secondary-hold, secondary, ineligible, or disabled. Multiple event types, such as interface monitoring, Services Processing Unit (SPU) monitoring, failures, and manual failovers, can trigger a state transition.

## Enable Chassis Cluster Formation

You create two vSRX Virtual Firewall instances to form a chassis cluster, and then you set the cluster ID and node ID on each instance to join the cluster. When a vSRX Virtual Firewall instance joins a cluster, it becomes a node of that cluster. With the exception of unique node settings and management IP addresses, nodes in a cluster share the same configuration.

You can deploy up to 255 chassis clusters in a *Layer 2* domain. Clusters and nodes are identified in the following ways:

- The *cluster ID* (a number from 1 to 255) identifies the cluster.
- The *node ID* (a number from 0 to 1) identifies the cluster node.

Generally, on SRX Series Firewalls, the cluster ID and node ID are written into EEPROM. On the vSRX Virtual Firewall instance, vSRX Virtual Firewall stores and reads the IDs from **boot/loader.conf** and uses the IDs to initialize the chassis cluster during startup.

### Prerequisites

Ensure that your vSRX Virtual Firewall instances comply with the following prerequisites before you enable chassis clustering:

- You have committed a basic configuration to both vSRX Virtual Firewall instances that form the chassis cluster. See *Configure vSRX Using the CLI*.
- Use `show version` in Junos OS to ensure that both vSRX Virtual Firewall instances have the same software version.
- Use `show system license` in Junos OS to ensure that both vSRX Virtual Firewall instances have the same licenses installed.

You must set the same chassis cluster ID on each vSRX Virtual Firewall node and reboot the vSRX Virtual Firewall VM to enable chassis cluster formation.

1. In operational command mode, set the chassis cluster ID and node number on vSRX Virtual Firewall node 0.

```
user@vsrx0>set chassis cluster cluster-id number node 0 reboot
```

2. In operational command mode, set the chassis cluster ID and node number on vSRX Virtual Firewall node 1.

```
user@vsrx1>set chassis cluster cluster-id number node 1 reboot
```

**NOTE:** The vSRX Virtual Firewall interface naming and mapping to vNICs changes when you enable chassis clustering. See *Requirements for vSRX on KVM* for a summary of interface names and mappings for a pair of vSRX Virtual Firewall VMs in a cluster (node 0 and node 1).

## Chassis Cluster Quick Setup with J-Web

To configure chassis cluster from *J-Web*:

1. Enter the vSRX Virtual Firewall node 0 interface IP address in a Web browser.
2. Enter the vSRX Virtual Firewall username and password, and click **Log In**. The J-Web dashboard appears.
3. Click **Configuration Wizards> Cluster (HA) Setup** from the left panel. The Chassis Cluster Setup Wizard appears. Follow the steps in the setup wizard to configure the cluster ID and the two nodes in the cluster, and to verify connectivity.

**NOTE:** Use the built-in Help icon in J-Web for further details on the Chassis Cluster Setup wizard.

**NOTE:** Navigate to **Configure>Device Settings>Cluster (HA) Setup** from Junos OS release 18.1 and later to configure the chassis cluster setup.

4. Configure the secondary node Node1 by selecting **Yes, this is the secondary unit to be setup (Node 1)** using radio button.
5. Click **Next**.
6. Specify the settings such as **Enter password**, **Re-enter password**, **Node 0 FXPO IP**, and **Node 1 FXPO IP** for secondary node access.
7. Click **Next**.
8. Select the secondary unit's Control Port and Fabric Port.
9. Click **Next**.
10. (Optional) Select **Save a backup file before proceeding with shutdown** using check box to re-configure it for chassis cluster.

11. Click **Next**.
12. Click **Shutdown and continue** to connect to other unit.
13. Click **Refresh Browser**.
14. Configure the primary node Node0 by selecting **No, this is the primary unit to be setup (Node 0)** to configure primary unit and establish a chassis cluster configuration.
15. Click **Next**.
16. Specify the settings such as **Enter password**, **Re-enter password**, **Node 0 FXPO IP**, and **Node 1 FXPO IP** for primary node access.
17. Click **Next** to restart the primary unit.
18. (Optional) Select **Save a backup file before proceeding with shutdown** to save a backup file of current settings before proceeding.
19. Click **Reboot and continue**. After completing the reboot, power on the secondary unit to establish the chassis cluster connection.
20. Login to the device console and add static route to get the J-Web access.
21. Login to the J-Web and click **Configuration Wizards> Cluster (HA) Setup** from the left panel. The Chassis Cluster Setup Wizard appears.
22. Click **Next** to get the primary unit connected.
23. Configure the basic settings **DHCP Client**, **IP address**, **Default gateway**, **Member interface Node 0**, **Member interface Node 1**.
24. Click **Next** to complete the chassis cluster configuration.
25. Click **Finish** to exit the wizard. You can access the primary node using J-Web.

## Manually Configure a Chassis Cluster with J-Web

You can use the *J-Web* interface to configure the primary node 0 vSRX Virtual Firewall instance in the cluster. Once you have set the cluster and node IDs and rebooted each vSRX Virtual Firewall, the following configuration will automatically be synced to the secondary node 1 vSRX Virtual Firewall instance.

Select **Configure>Chassis Cluster>Cluster Configuration**. The Chassis Cluster configuration page appears.

**NOTE:** Navigate to **Configure>Device Settings>Cluster (HA) Setup** from Junos OS release 18.1 and later to configure the HA cluster setup.

[Table 16 on page 99](#) explains the contents of the HA Cluster Settings tab.

[Table 17 on page 100](#) explains how to edit the Node Settings tab.

[Table 18 on page 101](#) explains how to add or edit the HA Cluster Interfaces table.

Table 19 on page 102 explains how to add or edit the HA Cluster Redundancy Groups table.

**Table 16: Chassis Cluster Configuration Page**

Field	Function
<b>Node Settings</b>	
Node ID	Displays the node ID.
Cluster ID	Displays the cluster ID configured for the node.
Host Name	Displays the name of the node.
Backup Router	Displays the router used as a gateway while the Routing Engine is in secondary state for redundancy-group 0 in a chassis cluster.
Management Interface	Displays the management interface of the node.
IP Address	Displays the management IP address of the node.
Status	Displays the state of the redundancy group. <ul style="list-style-type: none"> <li>• <b>Primary</b>—Redundancy group is active.</li> <li>• <b>Secondary</b>—Redundancy group is passive.</li> </ul>
<b>Chassis Cluster&gt;HA Cluster Settings&gt;Interfaces</b>	
Name	Displays the physical interface name.
Member Interfaces/IP Address	Displays the member interface name or IP address configured for an interface.
Redundancy Group	Displays the redundancy group.
<b>Chassis Cluster&gt;HA Cluster Settings&gt;Redundancy Group</b>	

Table 16: Chassis Cluster Configuration Page (Continued)

Field	Function
Group	Displays the redundancy group identification number.
Preempt	Displays the selected preempt option. <ul style="list-style-type: none"> <li>• <b>True</b>–Primary Role can be preempted based on priority.</li> <li>• <b>False</b>–Primary Role cannot be preempted based on priority.</li> </ul>
Gratuitous ARP Count	Displays the number of gratuitous Address Resolution Protocol ( <i>ARP</i> ) requests that a newly elected primary device in a chassis cluster sends out to announce its presence to the other network devices.
Node Priority	Displays the assigned priority for the redundancy group on that node. The eligible node with the highest priority is elected as primary for the redundant group.

Table 17: Edit Node Setting Configuration Details

Field	Function	Action
<b>Node Settings</b>		
Host Name	Specifies the name of the host.	Enter the name of the host.
Backup Router	Displays the device used as a gateway while the Routing Engine is in the secondary state for redundancy-group 0 in a chassis cluster.	Enter the IP address of the backup router.
<b>Destination</b>		
IP	Adds the destination address.	Click <b>Add</b> .
Delete	Deletes the destination address.	Click <b>Delete</b> .

Table 17: Edit Node Setting Configuration Details (Continued)

Field	Function	Action
<b>Interface</b>		
Interface	Specifies the interfaces available for the router.  <b>NOTE:</b> Allows you to add and edit two interfaces for each fabric link.	Select an option.
IP	Specifies the interface IP address.	Enter the interface IP address.
Add	Adds the interface.	Click <b>Add</b> .
Delete	Deletes the interface.	Click <b>Delete</b> .

Table 18: Add HA Cluster Interface Configuration Details

Field	Function	Action
<b>Fabric Link &gt; Fabric Link 0 (fab0)</b>		
Interface	Specifies fabric link 0.	Enter the interface IP fabric link 0.
Add	Adds fabric interface 0.	Click <b>Add</b> .
Delete	Deletes fabric interface 0.	Click <b>Delete</b> .
<b>Fabric Link &gt; Fabric Link 1 (fab1)</b>		
Interface	Specifies fabric link 1.	Enter the interface IP for fabric link 1.
Add	Adds fabric interface 1.	Click <b>Add</b> .
Delete	Deletes fabric interface 1.	Click <b>Delete</b> .

Table 18: Add HA Cluster Interface Configuration Details (Continued)

Field	Function	Action
<b>Redundant Ethernet</b>		
Interface	Specifies a logical interface consisting of two physical Ethernet interfaces, one on each chassis.	Enter the logical interface.
IP	Specifies a redundant Ethernet IP address.	Enter a redundant Ethernet IP address.
Redundancy Group	Specifies the redundancy group ID number in the chassis cluster.	Select a redundancy group from the list.
Add	Adds a redundant Ethernet IP address.	Click <b>Add</b> .
Delete	Deletes a redundant Ethernet IP address.	Click <b>Delete</b> .

Table 19: Add Redundancy Groups Configuration Details

Field	Function	Action
Redundancy Group	Specifies the redundancy group name.	Enter the redundancy group name.
Allow preemption of primaryship	Allows a node with a better priority to initiate a failover for a redundancy group.  <b>NOTE:</b> By default, this feature is disabled. When disabled, a node with a better priority does not initiate a redundancy group failover (unless some other factor, such as faulty network connectivity identified for monitored interfaces, causes a failover).	-

Table 19: Add Redundancy Groups Configuration Details (Continued)

Field	Function	Action
Gratuitous ARP Count	Specifies the number of gratuitous Address Resolution Protocol requests that a newly elected primary sends out on the active redundant Ethernet interface child links to notify network devices of a change in primary role on the redundant Ethernet interface links.	Enter a value from 1 to 16. The default is 4.
node0 priority	Specifies the priority value of node0 for a redundancy group.	Enter the node priority number as 0.
node1 priority	Specifies the priority value of node1 for a redundancy group.	Select the node priority number as 1.
<b>Interface Monitor</b>		
Interface	Specifies the number of redundant Ethernet interfaces to be created for the cluster.	Select an interface from the list.
Weight	Specifies the weight for the interface to be monitored.	Enter a value from 1 to 125.
Add	Adds interfaces to be monitored by the redundancy group along with their respective weights.	Click <b>Add</b> .
Delete	Deletes interfaces to be monitored by the redundancy group along with their respective weights.	Select the interface from the configured list and click <b>Delete</b> .
<b>IP Monitoring</b>		
Weight	Specifies the global weight for IP monitoring.	Enter a value from 0 to 255.
Threshold	Specifies the global threshold for IP monitoring.	Enter a value from 0 to 255.



Table 19: Add Redundancy Groups Configuration Details (*Continued*)

Field	Function	Action
Retry Count	Specifies the number of retries needed to declare reachability failure.	Enter a value from 5 to 15.
Retry Interval	Specifies the time interval in seconds between retries.	Enter a value from 1 to 30.

#### IPv4 Addresses to Be Monitored

IP	Specifies the IPv4 addresses to be monitored for reachability.	Enter the IPv4 addresses.
Weight	Specifies the weight for the redundancy group interface to be monitored.	Enter the weight.
Interface	Specifies the logical interface through which to monitor this IP address.	Enter the logical interface address.
Secondary IP address	Specifies the source address for monitoring packets on a secondary link.	Enter the secondary IP address.
Add	Adds the IPv4 address to be monitored.	Click <b>Add</b> .
Delete	Deletes the IPv4 address to be monitored.	Select the IPv4 address from the list and click <b>Delete</b> .

#### SEE ALSO

[Chassis Cluster Feature Guide for Security Devices](#)

## Verify the Chassis Cluster Configuration

### IN THIS SECTION

- Purpose | 105
- Action | 105

### Purpose

Verify that the chassis cluster is operational after you set up the vSRX Virtual Firewall instances for clustering and set the cluster ID and the node ID.

### Action

After reboot, the two nodes are reachable on interface fxp0 with SSH. If the configuration is operational, the `show chassis cluster status` command displays output similar to that shown in the following sample output.

```
vSRX Virtual Firewall> show chassis cluster status
```

```
Cluster ID: 1
Node          Priority      Status      Preempt  Manual Monitor-failures

Redundancy group: 0 , Failover count: 1
  node0        100         secondary   no       no       None
  node1        10          primary     no       no       None

Redundancy group: 1 , Failover count: 2
  node0        100         secondary   no       no       None
  node1        10          primary     no       no       None
```

A cluster is healthy when both the primary and the secondary nodes are present and when both have a priority greater than 0.

# 2

PART

## vSRX Virtual Firewall Deployment for VMware

---

[Overview | 107](#)

[Install vSRX Virtual Firewall in VMware | 124](#)

[vSRX Virtual Firewall VM Management with VMware | 139](#)

[Configure vSRX Virtual Firewall Chassis Clusters in VMware | 150](#)

---

# Overview

## IN THIS CHAPTER

- [Understand vSRX Virtual Firewall with VMware | 107](#)
- [Requirements for vSRX Virtual Firewall on VMware | 115](#)

## Understand vSRX Virtual Firewall with VMware

### IN THIS SECTION

- [vSRX Virtual Firewall Overview | 107](#)
- [vSRX Virtual Firewall Benefits and Use Cases | 110](#)
- [vSRX Virtual Firewall on VMWare ESXi deployment | 111](#)
- [vSRX Virtual Firewall Scale Up Performance | 111](#)
- [vSRX Virtual Firewall Session Capacity Increase | 113](#)

This section presents an overview of vSRX Virtual Firewall on VMware

### vSRX Virtual Firewall Overview

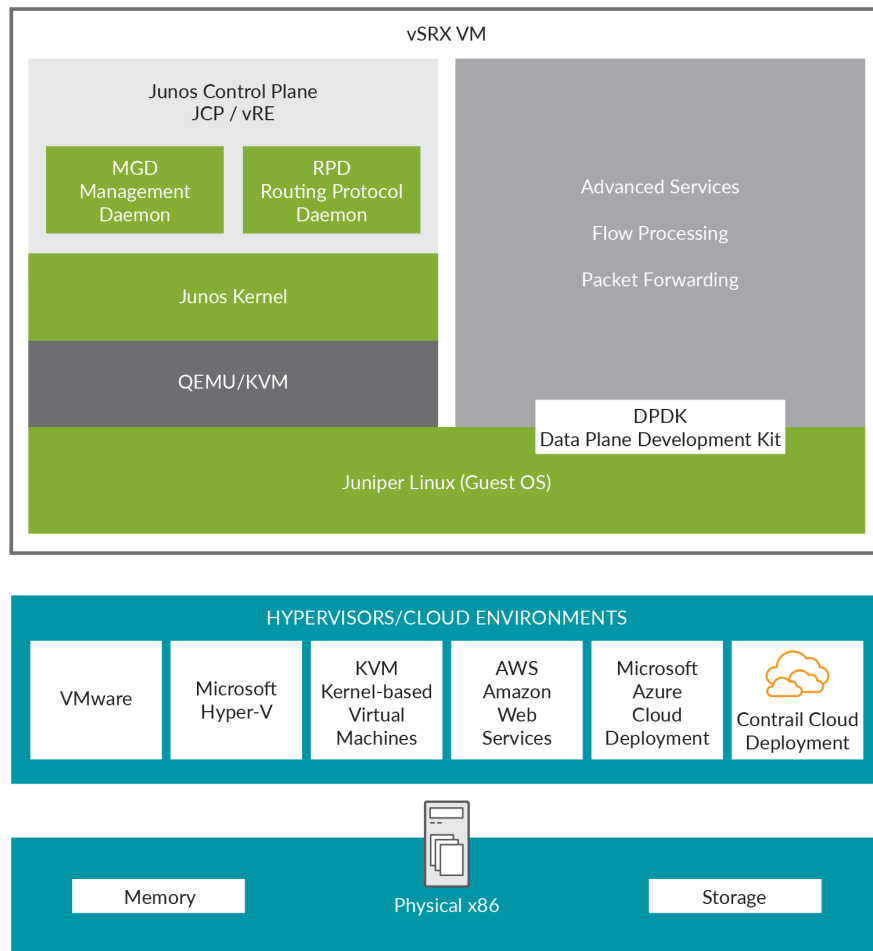
vSRX Virtual Firewall is a virtual security appliance that provides security and networking services at the perimeter or edge in virtualized private or public *cloud* environments. vSRX Virtual Firewall runs as a virtual machine (*VM*) on a standard x86 server. vSRX Virtual Firewall is built on the Junos operating system (Junos OS) and delivers networking and security features similar to those available on the software releases for the SRX Series Firewalls.

The vSRX Virtual Firewall provides you with a complete Next-Generation Firewall (NGFW) solution, including core firewall, VPN, NAT, advanced Layer 4 through Layer 7 security services such as Application Security, intrusion detection and prevention (IPS), and Content Security features including

Enhanced Web Filtering and Anti-Virus. Combined with ATP Cloud, the vSRX Virtual Firewall offers a cloud-based advanced anti-malware service with dynamic analysis to protect against sophisticated malware, and provides built-in machine learning to improve verdict efficacy and decrease time to remediation.

Figure 14 on page 108 shows the high-level architecture.

**Figure 14: vSRX Virtual Firewall Architecture**



vSRX Virtual Firewall includes the Junos control plane (JCP) and the packet forwarding engine (PFE) components that make up the data plane. vSRX Virtual Firewall uses one virtual CPU (vCPU) for the JCP and at least one vCPU for the PFE. Starting in Junos OS Release 15.1X49-D70 and Junos OS Release 17.3R1, multi-core vSRX Virtual Firewall supports scaling vCPUs and GB virtual RAM (vRAM). Additional vCPUs are applied to the data plane to increase performance.

Junos OS Release 18.4R1 supports a new software architecture vSRX Virtual Firewall 3.0 that removes dual OS and nested virtualization requirement of existing vSRX Virtual Firewall architecture.

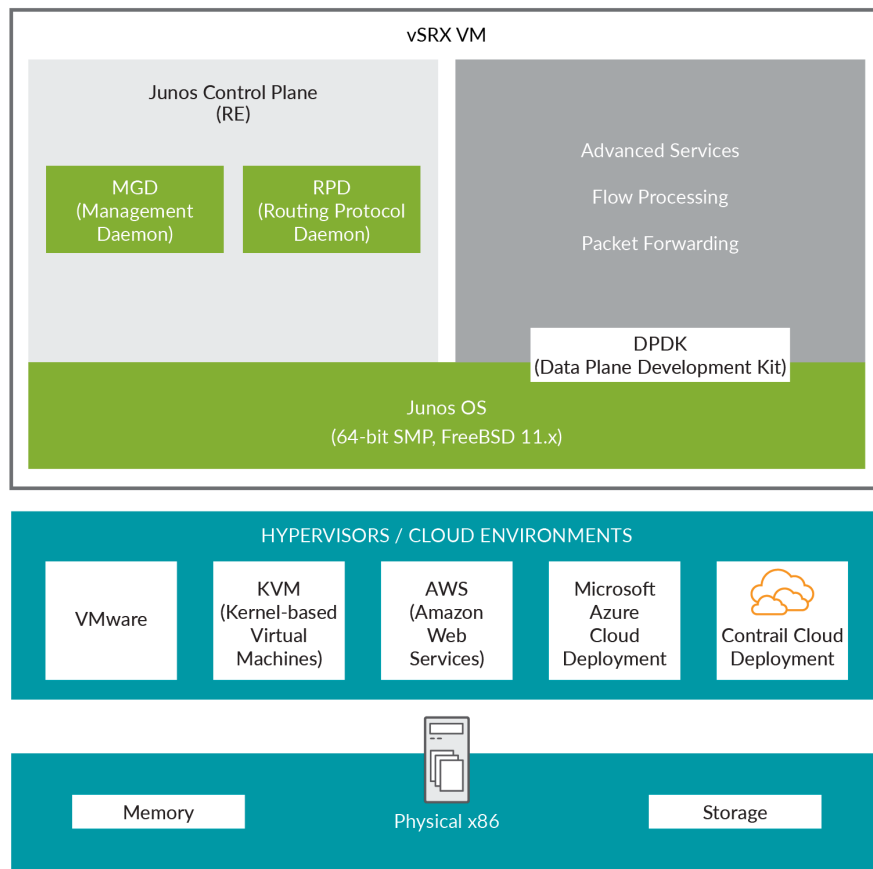
In vSRX Virtual Firewall 3.0 architecture, FreeBSD 11.x is used as the guest OS and the Routing Engine and Packet Forwarding Engine runs on FreeBSD 11.x as single virtual machine for improved performance and scalability. vSRX Virtual Firewall 3.0 uses DPDK to process the data packets in the data plane. A direct Junos upgrade from vSRX Virtual Firewall to vSRX Virtual Firewall 3.0 software is not supported.

vSRX Virtual Firewall 3.0 has the following enhancements compared to vSRX Virtual Firewall:

- Removed the restriction of requiring nested VM support in hypervisors.
- Removed the restriction of requiring ports connected to control plane to have Promiscuous mode enabled.
- Improved boot time and enhanced responsiveness of the control plane during management operations.
- Improved live migration.

[Figure 15 on page 110](#) shows the high-level software architecture for vSRX Virtual Firewall 3.0

Figure 15: vSRX Virtual Firewall 3.0 Architecture



## vSRX Virtual Firewall Benefits and Use Cases

vSRX Virtual Firewall on standard x86 servers enables you to quickly introduce new services, deliver customized services to customers, and scale security services based on dynamic needs. vSRX Virtual Firewall is ideal for public, private, and hybrid cloud environments.

Some of the key benefits of vSRX Virtual Firewall in a virtualized private or public cloud multitenant environment include:

- *Stateful firewall* protection at the tenant edge
- Faster deployment of virtual firewalls into new sites
- Ability to run on top of various hypervisors and public cloud infrastructures
- Full routing, *VPN*, core security, and networking capabilities
- Application security features (including IPS and App-Secure)

- Content security features (including Anti Virus, Web Filtering, Anti Spam, and Content Filtering)
- Centralized management with Junos Space Security Director and local management with J-Web Interface
- Juniper Networks Juniper Advanced Threat Prevention Cloud (ATP Cloud) integration

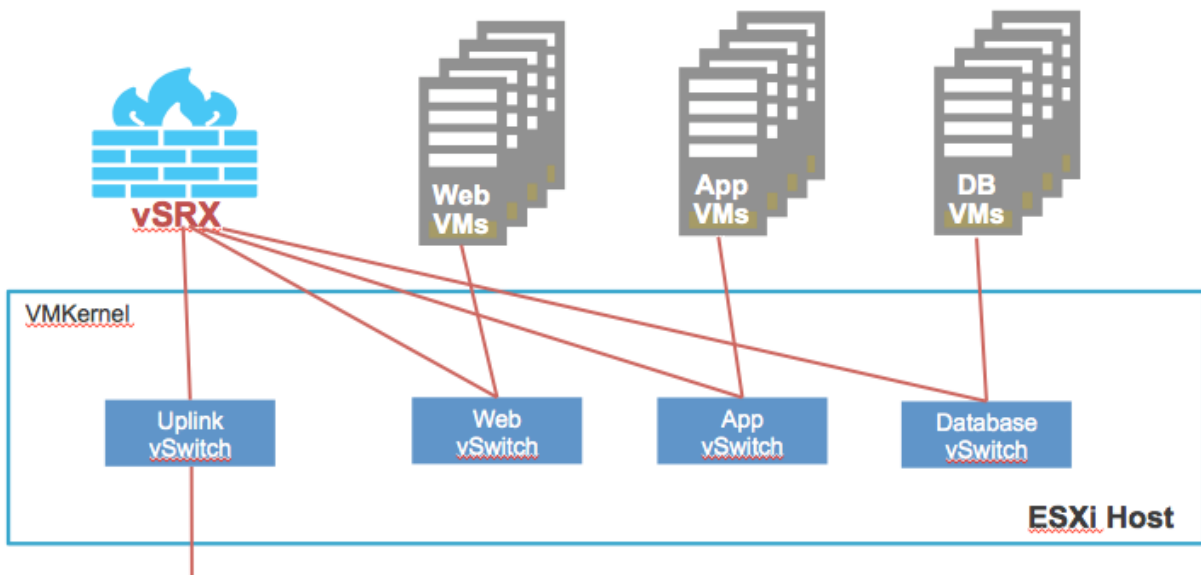
## vSRX Virtual Firewall on VMWare ESXi deployment

VMware vSphere is a virtualization environment for systems supporting the x86 architecture. VMware ESXi® is the hypervisor used to create and run virtual machines (VMs) and virtual appliances on a host machine. The VMware vCenter Server® is a service that manages the resources of multiple ESXi hosts.

The VMware vSphere Web Client is used to deploy the vSRX Virtual Firewall VM.

Figure 16 on page 111 shows an example of how vSRX Virtual Firewall can be deployed to provide security for applications running on one or more virtual machines. The vSRX Virtual Firewall virtual switch has a connection to a physical adapter (the uplink) so that all application traffic flows through the vSRX Virtual Firewall VM to the external network.

Figure 16: Example of vSRX Virtual Firewall Deployment



## vSRX Virtual Firewall Scale Up Performance

Table 20 on page 112 shows the vSRX Virtual Firewall scale up performance based on the number of vCPUs and vRAM applied to a vSRX Virtual Firewall VM. The table outlines the Junos OS release in



which a particular software specification for deploying vSRX Virtual Firewall on VMware was introduced. You will need to download a specific Junos OS release to take advantage of certain scale up performance features.

**Table 20: vSRX Virtual Firewall Scale Up Performance**

vCPUs	vRAM	NICs	Junos OS Release Introduced
2 vCPUs	4 GB	<ul style="list-style-type: none"> <li>SR-IOV (Intel 82599, X520/X540)</li> <li>VMNET3</li> </ul>	Junos OS Release 15.1X49-D15 and Junos OS Release 17.3R1
5 vCPUs	8 GB	<ul style="list-style-type: none"> <li>SR-IOV (Intel 82599, X520/X540)</li> <li>VMNET3</li> </ul>	Junos OS Release 15.1X49-D70 and Junos OS Release 17.3R1
9 vCPUs	16 GB	<ul style="list-style-type: none"> <li>SR-IOV (Mellanox ConnectX-3/ConnectX-3 Pro and Mellanox ConnectX-4 EN/ConnectX-4 Lx EN)</li> </ul> <p><b>NOTE:</b> SR-IOV (Mellanox ConnectX-3/ConnectX-3 Pro and Mellanox ConnectX-4 EN/ConnectX-4 Lx EN) is required if you intend to scale the performance and capacity of a vSRX Virtual Firewall to 9 vCPUs and 16 GB vRAM.</p>	Junos OS Release 18.4R1
17 vCPUs	32 GB	<ul style="list-style-type: none"> <li>SR-IOV (Mellanox ConnectX-3/ConnectX-3 Pro and Mellanox ConnectX-4 EN/ConnectX-4 Lx EN)</li> </ul> <p><b>NOTE:</b> SR-IOV (Mellanox ConnectX-3/ConnectX-3 Pro and Mellanox ConnectX-4 EN/ConnectX-4 Lx EN) is required if you intend to scale the performance and capacity of a vSRX Virtual Firewall to 17 vCPUs and 32 GB vRAM.</p>	Junos OS Release 18.4R1
1 vCPU	4 GB	SR-IOV on the Mellanox ConnectX-3 and ConnectX-4 family adapters.	Junos OS Release 21.2R1
4 vCPUs	8 GB	SR-IOV on the Mellanox ConnectX-3 and ConnectX-4 family adapters.	Junos OS Release 21.2R1

**Table 20: vSRX Virtual Firewall Scale Up Performance (Continued)**

vCPUs	vRAM	NICs	Junos OS Release Introduced
8 vCPUs	16GB	SR-IOV on the Mellanox ConnectX-3 and ConnectX-4 family adapters.	Junos OS Release 21.2R1
16 vCPUs	32 GB	SR-IOV on the Mellanox ConnectX-3 and ConnectX-4 family adapters.	Junos OS Release 21.2R1

You can scale the performance and capacity of a vSRX Virtual Firewall instance by increasing the number of vCPUs and the amount of vRAM allocated to the vSRX Virtual Firewall. The multi-core vSRX Virtual Firewall automatically selects the appropriate vCPUs and vRAM values at boot time, as well as the number of Receive Side Scaling (RSS) queues in the NIC. If the vCPU and vRAM settings allocated to a vSRX Virtual Firewall VM do not match what is currently available, the vSRX Virtual Firewall scales down to the closest supported value for the instance. For example, if a vSRX Virtual Firewall VM has 3 vCPUs and 8 GB of vRAM, vSRX Virtual Firewall boots to the smaller vCPU size, which requires a minimum of 2 vCPUs. You can scale up a vSRX Virtual Firewall instance to a higher number of vCPUs and amount of vRAM, but you cannot scale down an existing vSRX Virtual Firewall instance to a smaller setting.

**NOTE:** The number of RSS queues typically matches with the number of data plane vCPUs of a vSRX Virtual Firewall instance. For example, a vSRX Virtual Firewall with 4 data plane vCPUs should have 4 RSS queues.

## vSRX Virtual Firewall Session Capacity Increase

vSRX Virtual Firewall solution is optimized to increase the session numbers by increasing the memory.

With the ability to increase the session numbers by increasing the memory, you can enable vSRX Virtual Firewall to:

- Provide highly scalable, flexible and high-performance security at strategic locations in the mobile network.
- Deliver the performance that service providers require to scale and protect their networks.

Run the `show security flow session summary | grep maximum` command to view the maximum number of sessions.

Starting in Junos OS Release 18.4R1, the number of flow sessions supported on a vSRX Virtual Firewall instance is increased based on the vRAM size used.

Starting in Junos OS Release 19.2R1, the number of flow sessions supported on a vSRX Virtual Firewall 3.0 instance is increased based on the vRAM size used.

[Table 21 on page 114](#) lists the flow session capacity.

**Table 21: vSRX Virtual Firewall and vSRX Virtual Firewall 3.0 Flow Session Capacity Details**

vCPUs	Memory	Flow Session Capacity
2	4 GB	0.5 M
2	6 GB	1 M
2/5	8 GB	2 M
2/5	10 GB	2 M
2/5	12 GB	2.5 M
2/5	14 GB	3 M
2/5/9	16 GB	4 M
2/5/9	20 GB	6 M
2/5/9	24 GB	8 M
2/5/9	28 GB	10 M
2/5/9/17	32 GB	12 M
2/5/9/17	40 GB	16 M
2/5/9/17	48 GB	20 M

**Table 21: vSRX Virtual Firewall and vSRX Virtual Firewall 3.0 Flow Session Capacity Details**  
(Continued)

vCPUs	Memory	Flow Session Capacity
2/5/9/17	56 GB	24 M
2/5/9/17	64 GB	28 M

#### Release History Table

Release	Description
19.2R1	Starting in Junos OS Release 19.2R1, the number of flow sessions supported on a vSRX Virtual Firewall 3.0 instance is increased based on the vRAM size used.
18.4R1	Starting in Junos OS Release 18.4R1, the number of flow sessions supported on a vSRX Virtual Firewall instance is increased based on the vRAM size used.
15.1X49-D70	Starting in Junos OS Release 15.1X49-D70 and Junos OS Release 17.3R1, multi-core vSRX Virtual Firewall supports scaling vCPUs and GB virtual RAM (vRAM). Additional vCPUs are applied to the data plane to increase performance.

#### RELATED DOCUMENTATION

[VMware vSphere](#)

[RSS: Receive Side Scaling](#)

## Requirements for vSRX Virtual Firewall on VMware

#### IN THIS SECTION

- [Software Specifications | 116](#)
- [Best Practices for Improving vSRX Virtual Firewall Performance | 119](#)
- [Interface Mapping for vSRX Virtual Firewall on VMware | 120](#)

## Software Specifications

No Link Title lists the system software requirement specifications when deploying vSRX Virtual Firewall on VMware. The table outlines the Junos OS release in which a particular software specification for deploying vSRX Virtual Firewall on VMware was introduced. You must need to download a specific Junos OS release to take advantage of certain features.

**Table 22: Feature Support on vSRX Virtual Firewall**

Features	Specification	Junos OS Release Introduced
vCPUs/Memory	2 vCPUs / 4 GB RAM	Junos OS Release 15.1X49-D15 and Junos OS Release 17.3R1 (vSRX Virtual Firewall)
	5 vCPUs / 8 GB RAM	Junos OS Release 15.1X49-D70 and Junos OS Release 17.3R1 (vSRX Virtual Firewall)
	9 vCPUs / 16 GB RAM	Junos OS Release 18.4R1 (vSRX Virtual Firewall) Junos OS Release 19.1R1 (vSRX Virtual Firewall 3.0)
	17 vCPUs / 32 GB RAM	Junos OS Release 18.4R1 (vSRX Virtual Firewall) Junos OS Release 19.1R1 (vSRX Virtual Firewall 3.0)
Flexible flow session capacity scaling by an additional vRAM	NA	Junos OS Release 19.1R1 (vSRX Virtual Firewall) Junos OS Release 19.2R1 (vSRX Virtual Firewall 3.0)

Table 22: Feature Support on vSRX Virtual Firewall (*Continued*)

Features	Specification	Junos OS Release Introduced
Multicore scaling support (Software RSS)	NA	Junos OS Release 19.3R1 (vSRX Virtual Firewall 3.0 only)
Reserve additional vCPU cores for the Routing Engine (vSRX Virtual Firewall and vSRX Virtual Firewall 3.0)	NA	
Virtio (virtio-net, vhost-net) (vSRX Virtual Firewall and vSRX Virtual Firewall 3.0)	NA	
<b>Supported Hypervisors</b>		
Hypervisor support	VMware ESXi 5.1, 5.5, 6.0, and 6.5 (vSRX Virtual Firewall and vSRX Virtual Firewall 3.0)	Junos OS Release 18.4R1
	VMware ESXi 6.7 (vSRX Virtual Firewall 3.0 only)	Junos OS Release 19.3R1
	VMware ESXi 7.0 (vSRX Virtual Firewall 3.0 only)	Junos OS Release 20.1R2
<b>Other Features</b>		
Cloud-init	NA	
Powermode IPSec (PMI)	NA	
Chassis cluster	NA	
GTP TEID based session distribution using Software RSS	NA	Junos OS Release 19.3R1 onwards

Table 22: Feature Support on vSRX Virtual Firewall (*Continued*)

Features	Specification	Junos OS Release Introduced
On-device antivirus scan engine (Avira)	NA	Junos OS Release 19.4R1 onwards
LLDP	NA	Junos OS Release 21.1R1 onwards
Junos Telemetry Interface	NA	Junos OS Release 20.3R1 onwards
<b>System Requirements</b>		
Hardware acceleration/enabled VMX CPU flag in the hypervisor (vSRX Virtual Firewall only)	NA	
Disk space	16 GB (IDE or SCSI drives) (vSRX Virtual Firewall)	Junos OS Release 15.1X49-D15 and Junos OS Release 17.3R1
	18 GB (vSRX Virtual Firewall 3.0)	

Table 23: vNIC Support on vSRX Virtual Firewall

vNICs	Junos OS Release Introduced
VMXNET3 SA and HA	
SR-IOV SA and HA over Intel X710/XL710/XXV710 series (vSRX Virtual Firewall 3.0)	Junos OS Release 20.4R2 onwards
SR-IOV HA on I40E ( X710,X740,X722 and so on) (vSRX Virtual Firewall 3.0)	Not supported
SR-IOV SA over Intel E810 series	
SR-IOV HA over Intel E810 series	Not supported
SR-IOV SA and HA over Mellanox ConnectX-3	Not supported

**Table 23: vNIC Support on vSRX Virtual Firewall (Continued)**

vNICs	Junos OS Release Introduced
SR-IOV SA and HA over Mellanox ConnectX-4/5/6 (MLX5 driver only)	(SA from Junos OS Release 21.2R1 onwards)  (HA from Junos OS Release 21.2R2 onwards)
PCI passthrough over Intel 82599/X520 series	Not supported
PCI passthrough over Intel X710/XL710 series	Not supported on vSRX Virtual Firewall 3.0
DPDK version has been upgraded from 17.02 to 17.11.2 to support the Mellanox Family Adapters.	Junos OS Release 18.4R1
Data Plane Development Kit (DPDK) version 18.11  DPDK version 18.11 is supported on vSRX Virtual Firewall. With this feature the Mellanox Connect Network Interface Card (NIC) on vSRX Virtual Firewall now supports OSPF Multicast and VLANs.	Junos OS Release 19.4R1

## Best Practices for Improving vSRX Virtual Firewall Performance

Review the following practices to improve vSRX Virtual Firewall performance.

### NUMA Nodes

The x86 server architecture consists of multiple sockets and multiple cores within a socket. Each socket also has memory that is used to store packets during I/O transfers from the NIC to the host. To efficiently read packets from memory, guest applications and associated peripherals (such as the NIC) should reside within a single socket. A penalty is associated with spanning CPU sockets for memory accesses, which might result in nondeterministic performance. For vSRX Virtual Firewall, we recommend that all vCPUs for the vSRX Virtual Firewall VM are in the same physical non-uniform memory access (NUMA) node for optimal performance.



**CAUTION:** The Packet Forwarding Engine (PFE) on the vSRX Virtual Firewall will become unresponsive if the NUMA nodes topology is configured in the hypervisor to



spread the instance's vCPUs across multiple host NUMA nodes. vSRX Virtual Firewall requires that you ensure that all vCPUs reside on the same NUMA node.

We recommend that you bind the vSRX Virtual Firewall instance with a specific NUMA node by setting NUMA node affinity. NUMA node affinity constrains the vSRX Virtual Firewall VM resource scheduling to only the specified NUMA node.

## PCI NIC-to-VM Mapping

If the node on which vSRX Virtual Firewall is running is different from the node to which the Intel PCI NIC is connected, then packets will have to traverse an additional hop in the QPI link, and this will reduce overall throughput. Use the `esxtop` command to view information about relative physical NIC locations. On some servers where this information is not available, refer to the hardware documentation for the slot-to-NUMA node topology.

## Interface Mapping for vSRX Virtual Firewall on VMware

Each network adapter defined for a vSRX Virtual Firewall is mapped to a specific interface, depending on whether the vSRX Virtual Firewall instance is a standalone VM or one of a cluster pair for high availability. The interface names and mappings in vSRX Virtual Firewall are shown in [Table 24 on page 121](#) and [Table 25 on page 121](#).

Note the following:

- In standalone mode:
  - `fxp0` is the out-of-band management interface.
  - `ge-0/0/0` is the first traffic (revenue) interface.
- In cluster mode:
  - `fxp0` is the out-of-band management interface.
  - `em0` is the cluster control link for both nodes.
  - Any of the traffic interfaces can be specified as the fabric links, such as `ge-0/0/0` for `fab0` on node 0 and `ge-7/0/0` for `fab1` on node 1.

[Table 24 on page 121](#) shows the interface names and mappings for a standalone vSRX Virtual Firewall VM.

**Table 24: Interface Names for a Standalone vSRX Virtual Firewall VM**

Network Adapter	Interface Name in Junos OS
1	fxp0
2	ge-0/0/0
3	ge-0/0/1
4	ge-0/0/2
5	ge-0/0/3
6	ge-0/0/4
7	ge-0/0/5
8	ge-0/0/6

[Table 25 on page 121](#) shows the interface names and mappings for a pair of vSRX Virtual Firewall VMs in a cluster (node 0 and node 1).

**Table 25: Interface Names for a vSRX Virtual Firewall Cluster Pair**

Network Adapter	Interface Name in Junos OS
1	fxp0 (node 0 and 1)
2	em0 (node 0 and 1)
3	ge-0/0/0 (node 0) ge-7/0/0 (node 1)

**Table 25: Interface Names for a vSRX Virtual Firewall Cluster Pair (Continued)**

Network Adapter	Interface Name in Junos OS
4	ge-0/0/1 (node 0) ge-7/0/1 (node 1)
5	ge-0/0/2 (node 0) ge-7/0/2 (node 1)
6	ge-0/0/3 (node 0) ge-7/0/3 (node 1)
7	ge-0/0/4 (node 0) ge-7/0/4 (node 1)
8	ge-0/0/5 (node 0) ge-7/0/5 (node 1)

### vSRX Virtual Firewall Default Settings on VMware

vSRX Virtual Firewall requires the following basic configuration settings:

- Interfaces must be assigned IP addresses.
- Interfaces must be bound to zones.
- Policies must be configured between zones to permit or deny traffic.

**NOTE:** With vSRX Virtual Firewall platforms, VMware uses the VMXNET 3 vNIC and requires promiscuous mode on the vSwitch for the management interface, fxp0.

Table 26 on page 123 lists the factory default settings for the vSRX Virtual Firewall security policies.

**Table 26: Factory Default Settings for Security Policies**

Source Zone	Destination Zone	Policy Action
trust	untrust	permit
trust	trust	permit
untrust	trust	deny

**RELATED DOCUMENTATION**[About Intel Virtualization Technology](#)[DPDK Release Notes](#)

# Install vSRX Virtual Firewall in VMware

## IN THIS CHAPTER

- Install vSRX Virtual Firewall with VMware vSphere Web Client | 124
- Load an Initial Configuration on a vSRX Virtual Firewall with VMware | 128
- Validate the vSRX Virtual Firewall .ova File for VMware | 135

## Install vSRX Virtual Firewall with VMware vSphere Web Client

The following procedure describes how to install vSRX Virtual Firewall and connect vSRX Virtual Firewall interfaces to the virtual switches for the appropriate applications. Only the vSRX Virtual Firewall virtual switch has a connection to a physical adapter (the uplink) so that all application traffic flows through the vSRX Virtual Firewall VM to the external network.

To install vSRX Virtual Firewall with the VMware vSphere Web Client:

**NOTE:** To upgrade an existing vSRX Virtual Firewall instance, see *Migration, Upgrade, and Downgrade* in the *vSRX Virtual Firewall Release Notes*.

1. Download the vSRX Virtual Firewall software package for VMware from the [Juniper Networks website](#).

**NOTE:** Do not change the filename of the downloaded software image or the installation will fail.

2. Validate the vSRX Virtual Firewall .ova file if required. For more information, see *Validate the vSRX .ova File for VMware*.
3. Enter the vCenter server hostname or address in your browser (<https://<ipaddress>:9443>) to access the vSphere Web Client, and log in to the vCenter server with your credentials.

4. Select a host or other valid parent for a virtual machine and click **Actions > All vCenter Actions > Deploy OVF Template**.

**NOTE:** The Client Integration Plug-in must be installed before you can deploy OVF templates (see your VMware documentation).

5. Click **Browse** to locate the vSRX Virtual Firewall software package, and then click **Next**.
6. Click **Next** in the OVF Template Details window.
7. Click **Accept** in the End User License Agreement window, and then click **Next**.
8. Change the default vSRX Virtual Firewall VM name in the Name box and click **Next**. It is advisable to keep this name the same as the hostname you intend to give to the VM.
9. In the Datastore window, do not change the default settings for:
  - Datastore
  - Available Space

Table 27 on page 125 lists the disk formats available to store the virtual disk. You can choose one of the three options listed.

**NOTE:** For detailed information on the disk formats, see [Virtual Disk Provisioning](#).

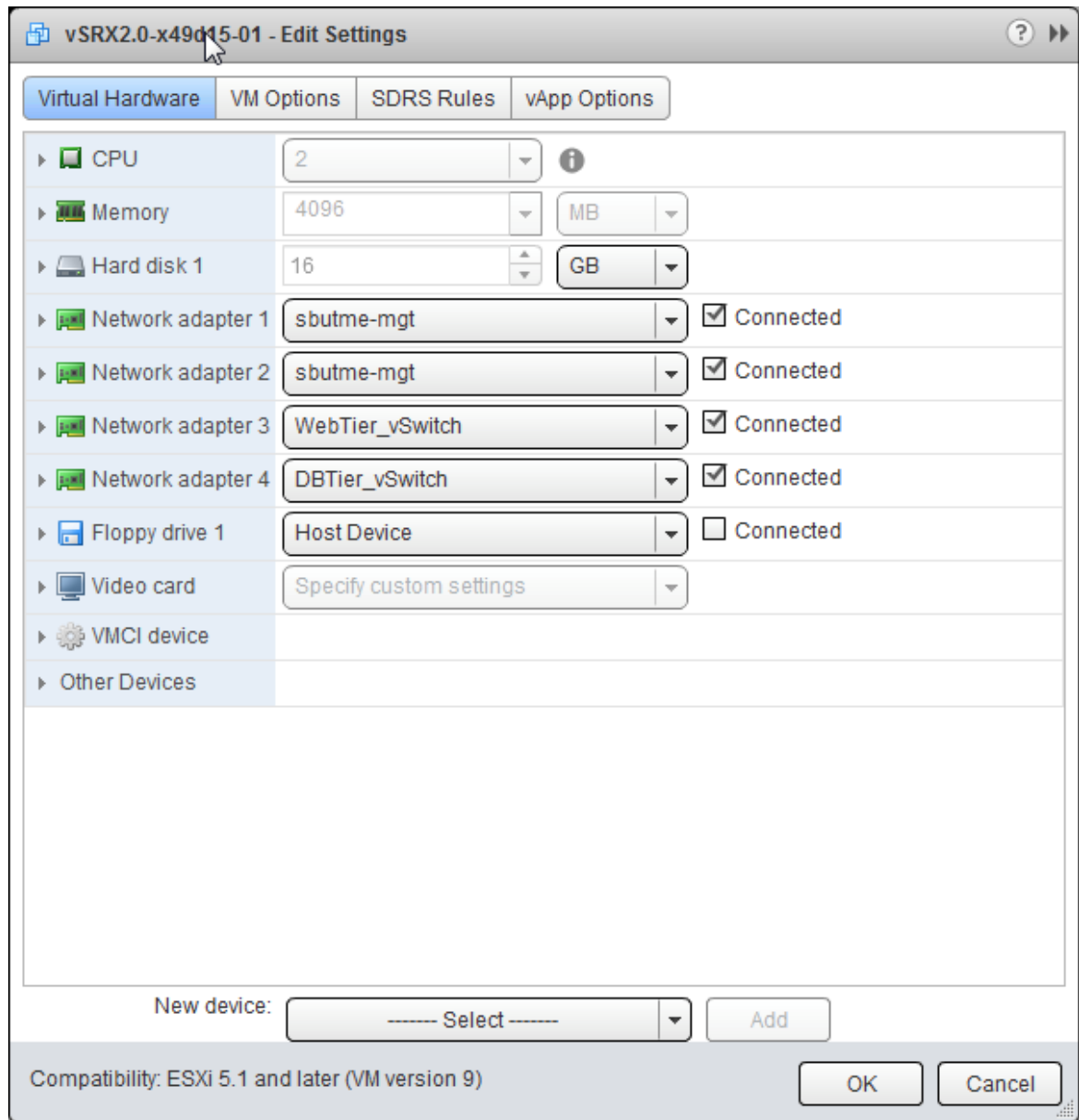
**Table 27: Disk Formats for Virtual Disk Storage**

Disk Format	Description
Thick Provision Lazy Zeroed	Allocates disk space to the virtual disk without erasing the previously stored data. The previous data is erased when the VM is used for the first time.
Thick Provision Eager Zeroed	Erases the previously stored data completely and then allocates the disk space to the virtual disk. Creation of disks in this format is time consuming.
Thin Provision	Allocates only as much datastore space as the disk needs for its initial operations. Use this format to save storage space.

10. Select a datastore to store the configuration file and virtual disk files in OVF template, and then click **Next**.
11. Select your management network from the list, and then click **Next**. The management network is assigned to the first network adapter, which is reserved for the management interface (fxp0).
12. Click **Finish** to complete the installation.
13. Open the Edit Settings page of the vSRX Virtual Firewall VM and select a virtual switch for each network adapter. Three network adapters are created by default. Network adapter 1 is for the management network (fxp0). To add a fourth adapter, select **Network** from New device list at the bottom of the page. To add more adapters, see *Add vSRX Interfaces*.

In [Figure 17 on page 127](#), network adapter 2 uses the management network for the uplink to the external network.

Figure 17: vSRX Virtual Firewall Edit Settings Page



14. Enable promiscuous mode for the management virtual switch:

With vSRX Virtual Firewall platforms VMware uses the VMXNET 3 vNIC and requires promiscuous mode on the vSwitch for the management interface, fxp0.

This step is not required on vSRX Virtual Firewall 3.0 and there is no need for the ports to be connected to the control plane to have Promiscuous mode enabled.

- a. Select the host where the vSRX Virtual Firewall VM is installed, and select **Manage > Networking > Virtual switches**.



- b. In the list of virtual switches, select vSwitch0 to view the topology diagram for the management network connected to network adapter 1.
- c. Click the **Edit** icon at the top of the list, select **Security**, and select **Accept** next to Promiscuous mode. Click **OK**.

**NOTE:** vSwitch1 corresponds to network adapter 2, vSwitch2 corresponds to network adapter 3, and so on.

15. Enable hardware-assisted virtualization to optimize performance of the vSRX Virtual Firewall Routing Engine that runs in a nested VM:
  - a. Power off the vSRX Virtual Firewall VM.
  - b. Right-click on the vSRX Virtual Firewall VM and select **Edit Settings**.
  - c. On the Virtual Hardware tab, expand CPU, select **Expose hardware-assisted virtualization to guest OS**, and click **OK**.

On the Manage tab, select **Settings > VM Hardware** and expand CPU to verify that the **Hardware virtualization** option is shown as Enabled.

**NOTE:** The default vSRX Virtual Firewall VM login ID is root with no password. By default, vSRX Virtual Firewall is assigned a DHCP-based IP address if a DHCP server is available on the network.

## RELATED DOCUMENTATION

[Using Virtual NUMA](#)

[Virtual Machine vCPU and vNUMA Rightsizing](#)

## Load an Initial Configuration on a vSRX Virtual Firewall with VMware

### IN THIS SECTION

- [Create a vSRX Virtual Firewall Bootstrap ISO Image | 132](#)

- [Upload an ISO Image to a VMWare Datastore | 133](#)
- [Provision vSRX Virtual Firewall with an ISO Bootstrap Image on VMWare | 134](#)

Starting in Junos OS Release 15.1X49-D40 and Junos OS Release 17.3R1, you can use a mounted ISO image to pass the initial startup Junos OS configuration to a vSRX Virtual Firewall VM. This ISO image contains a file in the root directory called `juniper.conf`. The configuration file uses curly brackets (`{}`) and indentation to display the hierarchical structure of the configuration. Terminating or leaf statements in the configuration hierarchy are displayed with a trailing semicolon (`;`) to define configuration details, such as root password, management IP address, default gateway, and other configuration statements. Also, vSRX Virtual Firewall reads the configuration file from the mounted ISO only when it boots up for the first time and does not read after the first boot.

**NOTE:** The `juniper.conf` file must be in the format same as displayed using `show configuration` command and it cannot be in `set` command format.

The process to bootstrap a vSRX Virtual Firewall VM with an ISO configuration image is as follows:

**NOTE:** SNMPv3 configuration is not supported when provisioning the vSRX Virtual Firewall platforms with an ISO bootstrap image.

1. Create the **juniper.conf** configuration file with your Junos OS configuration.

An example of a `juniper.conf` file follows.

```
system {
  host-name iso-mount-test;
  root-authentication {
    encrypted-password "$5$wCXP/Ma4$aqMJBhy82.wI643ijb73yHKK19TXApPycGKKn.PjpA8"; ##
  SECRET-DATA
  }
  login {
    user regress {
      uid 2001;
      class super-user;
      authentication {
        encrypted-password "$6$FGJM2YEb
```

```
$KTGIehvNt9Mf.u3ESWGB1aSQeXrSeg6zoCWZw0D6M6vnmWb8DAWsprNXyKZeW6M3kErFFTFtAuNpGjDjfwX4t."; ##
SECRET-DATA
    }
  }
}
services {
  ssh {
    root-login allow;
  }
  telnet;
  web-management {
    http {
      interface fxp0.0;
    }
  }
}
syslog {
  user * {
    any emergency;
  }
  file messages {
    any any;
    authorization info;
  }
  file interactive-commands {
    interactive-commands any;
  }
}
license {
  autoupdate {
    url https://ae1.juniper.net/junos/key_retrieval;
  }
}
}
security {
  forwarding-options {
    family {
      inet6 {
        mode flow-based;
      }
    }
  }
}
}
policies {
```

```
    default-policy {
        permit-all;
    }
}
zones {
    security-zone AAA {
        interfaces {
            all;
        }
    }
}
interfaces {
    ge-0/0/0 {
        vlan-tagging;
        unit 0 {
            vlan-id 77;
            family inet {
                address 10.1.1.0/24 {
                    arp 10.1.1.10 mac 00:10:12:34:12:34;
                }
            }
        }
    }
}
ge-0/0/1 {
    vlan-tagging;
    unit 0 {
        vlan-id 1177;
        family inet {
            address 10.1.1.1/24 {
                arp 10.1.1.10 mac 00:10:22:34:22:34;
            }
        }
    }
}
fxp0 {
    unit 0 {
        family inet {
            address 192.168.70.9/19;
        }
    }
}
```

```
    }  
  
  }  
  routing-options {  
    static {  
      route 0.0.0.0/0 next-hop 192.168.64.1;  
    }  
  }  
}
```

2. Create an ISO image that includes the **juniper.conf** file.
3. Mount the ISO image to the vSRX Virtual Firewall VM.
4. Boot or reboot the vSRX Virtual Firewall VM. vSRX Virtual Firewall will boot using the **juniper.conf** file included in the mounted ISO image.
5. Unmount the ISO image from the vSRX Virtual Firewall VM. To unmount the ISO image see [Dismount ISO Image from VM](#).

**NOTE:** If you do not unmount the ISO image after the initial boot or reboot, all subsequent configuration changes to the vSRX Virtual Firewall are overwritten by the ISO image on the next reboot.

## Create a vSRX Virtual Firewall Bootstrap ISO Image

This task uses a Linux system to create the ISO image.

To create a vSRX Virtual Firewall bootstrap ISO image:

1. Create a configuration file in plaintext with the Junos OS command syntax and save in a file called **juniper.conf**.
2. Create a new directory.

```
hostOS$ mkdir iso_dir
```

3. Copy `juniper.conf` to the new ISO directory.

```
hostOS$ cp juniper.conf iso_dir
```

**NOTE:** The `juniper.conf` file must contain the full vSRX Virtual Firewall configuration. The ISO bootstrap process overwrites any existing vSRX Virtual Firewall configuration.

4. Use the Linux `mkisofs` command to create the ISO image.

```
hostOS$ mkisofs -l -o test.iso iso_dir
```

```
I: -input-charset not specified, using utf-8 (detected in locale settings)
Total translation table size: 0
Total rockridge attributes bytes: 0
Total directory bytes: 0
Path table size(bytes): 10
Max brk space used 0
175 extents written (0 MB)
```

**NOTE:** The `-l` option allows for a long filename.

## SEE ALSO

| [Linux mkisofs command](#)

## Upload an ISO Image to a VMWare Datastore

To upload an ISO image to a datastore:

1. On the VMware vSphere Web Client, select the datastore you want to upload the file to.
2. Select the folder where you want to store the file and click **Upload a File** from the task bar.
3. Browse to the file on your local computer and click **Upload**.

Optionally, refresh the datastore to see the new file.

## Provision vSRX Virtual Firewall with an ISO Bootstrap Image on VMWare

To provision a vSRX Virtual Firewall VM with an ISO bootstrap image:

1. From VMware vSphere client, select the host server where the vSRX Virtual Firewall VM resides.
2. Right-click the vSRX Virtual Firewall VM and select **Edit Settings**. The Edit Setting dialogue box appears.
3. Select the Hardware tab and click **Add**. The Add Hardware dialog box opens.
4. Select the CD/DVD drive and click **Next**.
5. Select **Use ISO image** and click **Next**.
6. Click **Datastore ISO File**, browse to your bootstrap ISO image, and click **Next**.
7. Click **Next** and **Finish** to save this setting.
8. Click **OK** to save this CD drive to the VM.
9. Right-click the vSRX Virtual Firewall VM and select **Power>Power On** to boot the vSRX Virtual Firewall VM.
10. After the vSRX Virtual Firewall boots, verify the configuration and then select **Power> Power down** to shut down the vSRX Virtual Firewall so you can remove the ISO image.
11. Select the CD/DVD drive from the Hardware tab in the VMWare vSphere client.
12. Select the CD drive for the ISO file and click **Remove** to remove your bootstrap ISO image.
13. Click **OK** to save this setting.
14. Right-click the vSRX Virtual Firewall VM and select **Power>Power On** to boot the vSRX Virtual Firewall VM.

### Release History Table

Release	Description
15.1X49-D80	Starting in Junos OS Release 15.1X49-D40 and Junos OS Release 17.3R1, you can use a mounted ISO image to pass the initial startup Junos OS configuration to a vSRX Virtual Firewall VM. This ISO image contains a file in the root directory called juniper.conf. The configuration file uses curly brackets ({} and indentation to display the hierarchical structure of the configuration. Terminating or leaf statements in the configuration hierarchy are displayed with a trailing semicolon (;) to define configuration details, such as root password, management IP address, default gateway, and other configuration statements.

### RELATED DOCUMENTATION

| [Linux mkisofs command](#)

## Validate the vSRX Virtual Firewall .ova File for VMware

The vSRX Virtual Firewall open virtual application (OVA) image is securely signed. You can validate the OVA image, if necessary, but you can install or upgrade vSRX Virtual Firewall without validating the OVA image.

Before you validate the OVA image, ensure that the Linux/UNIX PC or Windows PC on which you are performing the validation has the following utilities available: tar, openssl, and ovftool. See the [OVF Tool Documentation](#) for details about the VMware Open Virtualization Format (OVF) tool, including a Software Download link.

To validate the OVA image on a Linux machine:

1. Download the vSRX Virtual Firewall OVA image and the Juniper Networks Root certificate file (**JuniperRootRSACA.pem**) from the vSRX Virtual Firewall [Juniper Networks Software Download](#) page.

**NOTE:** You need to download the Juniper Networks Root certificate file only once; you can use the same file to validate OVA images for future releases of vSRX Virtual Firewall.

2. (Optional) If you downloaded the OVA image and the certificate file to a PC running Windows, copy the two files to a temporary directory on a PC running Linux or UNIX. You can also copy the OVA image and the certificate file to a temporary directory (**/var/tmp** or **/tmp**) on a vSRX Virtual Firewall node.

Ensure that the OVA image file and the Juniper Networks Root certificate file are not modified during the validation procedure. You can do this by providing write access to these files only to the user performing the validation procedure. This is especially important if you use an accessible temporary directory, such as **/tmp** or **/var/tmp**, because such directories can be accessed by several users. Take precautions to ensure that the files are not modified by other users during the validation procedure.

3. Navigate to the directory containing the OVA image.

```
-bash-4.1$ ls
```

```
JuniperRootCA.pem  junos-vsrx-15.1X49-DXX.4-domestic.ova
```

4. Unpack the OVA image by running the following command: **tar xf *ova-filename*** where *ova-filename* is the filename of the previously downloaded OVA image.

```
-bash-4.1$ mkdir tmp
```

```
-bash-4.1$ cd tmp
```



```
-bash-4.1$ tar xf ../junos-vsrx-15.1X49-DXX.4-domestic.ova
```

5. Verify that the unpacked OVA image contains a certificate chain file (**certchain.pem**) and a signature file (**vsrx.cert**).

```
-bash-4.1$ ls
```

```
certchain.pem junos-vsrx-15.1X49-DXX.4-domestic.cert junos-vsrx-15.1X49-DXX.4-domestic-
disk1.vmdk junos-vsrx-15.1X49-DXX.4-domestic.mf junos-vsrx-15.1X49-DXX.4-domestic.ovf
```

6. Validate the unpacked OVF file (extension .ovf) by running the following command: **ovftool ovf-filename**

where *ovf-filename* is the filename of the unpacked OVF file contained within the previously downloaded OVA image.

```
-bash-4.1$ /usr/lib/vmware-ovftool/ovftool junos-vsrx-15.1X49-DXX.4-domestic.ovf
```

```
OVF version: 1.0
VirtualApp: false
Name: vSRX
Version: JUNOS 15.1
Vendor: Juniper Networks Inc.
Product URL:
             https://www.juniper.net/us/en/products-services/software/security/vsrxseries/
Vendor URL: https://www.juniper.net/
Download Size: 227.29 MB

Deployment Sizes:
  Flat disks: 2.00 GB
  Sparse disks: 265.25 MB

Networks:
  Name: VM Network
  Description: The VM Network network

Virtual Machines:
  Name: Juniper Virtual SRX
  Operating System: freebsdguest
  Virtual Hardware:
    Families: vmx-07
    Number of CPUs: 2
```

```

Cores per socket: 1
Memory:          2.00 GB

Disks:
  Index:         0
  Instance ID:   5
  Capacity:      2.00 GB
  Disk Types:    IDE

NICs:
  Adapter Type:  VMXNET3
  Connection:    VM Network

  Adapter Type:  VMXNET3
  Connection:    VM Network

Deployment Options:
  Id:            2GvRAM
  Label:         2G vRAM
  Description:
                  2G Memory

```

7. Validate the signing certificate with the Juniper Networks Root CA file by running the following command:

```
openssl verify -CAfile JuniperRootRSACA.pem -untrusted Certificate-Chain-File Signature-file
```

where **JuniperRootRSACA.pem** is the Juniper Networks Root CA file, *Certificate-Chain-File* is the filename of the unpacked certificate chain file (extension **.pem**) and *Signature-file* is the filename of the unpacked signature file (extension **.cert**).

```
-bash-4.1$ openssl verify -CAfile ../JuniperRootCA.pem -untrusted certchain.pem junos-vsrx-15.1X49-DXX.4-domestic.cert
```

```
junos-vsrx-15.1X49-DXX.4-domestic.cert: OK
```

8. (Optional) If you encounter validation issues with the OVA image:
- a. Determine if the contents of the OVA image have been modified. If the contents have been modified, download the OVA image from the vSRX Virtual Firewall downloads page.
  - b. Determine whether the Juniper Networks Root CA file is corrupted or modified. If it was corrupted or modified, download the certificate file from the vSRX Virtual Firewall downloads page.

- c. Retry the preceding validation steps using one or both new files.

# vSRX Virtual Firewall VM Management with VMware

## IN THIS CHAPTER

- Add vSRX Virtual Firewall Interfaces | 139
- Upgrade a Multicore vSRX Virtual Firewall with VMware | 142
- Automate the Initialization of vSRX Virtual Firewall 3.0 Instances on VMware Hypervisor using VMware Tools | 145

## Add vSRX Virtual Firewall Interfaces

### IN THIS SECTION

- Add SR-IOV Interfaces | 140
- Add VMXNET 3 Interfaces | 142

The network adapter for each interface uses SR-IOV or VMXNET 3 as the adapter type. The first network adapter is for the management interface (fxp0) and must use VMXNET 3. All additional network adapters should have the same adapter type. The three network adapters created by default use VMXNET 3.

**NOTE:** Starting in Junos OS Release 18.4R1:

- SR-IOV (Mellanox ConnectX-3/ConnectX-3 Pro and Mellanox ConnectX-4 EN/ConnectX-4 Lx EN) is required if you intend to scale the performance and capacity of a vSRX Virtual Firewall VM to 9 or 17 vCPUs and 16 or 32 GB vRAM.

- The DPDK version has been upgraded from 17.02 to 17.11.2 to support the Mellanox Family Adapters .

Starting in Junos OS Release 19.4R1, DPDK version 18.11 is supported on vSRX Virtual Firewall. With this feature the Mellanox Connect Network Interface Card (NIC) on vSRX Virtual Firewall now supports OSPF Multicast and VLANs.

The network adapters are mapped sequentially to the vSRX Virtual Firewall interfaces, as shown in [Requirements for vSRX on VMware](#).

**NOTE:** If you have used the interface mapping workaround required for prior Junos releases, you do not need to make any changes when you upgrade to Junos Release 15.1X49-D70 for vSRX Virtual Firewall.

The following procedures describe how to add more network adapters:

### Add SR-IOV Interfaces

SR-IOV interfaces must be added as PCI devices on VMware. To add an SR-IOV interface as a PCI Device, you must first select an available Virtual Function (VF) on the device.

**NOTE:** For fresh vSRX Virtual Firewall installations with SR-IOV on VMWare, the vSRX Virtual Firewall must be first deployed without adding SR-IOV or modifying the VMXNET3 NICs. Later vSRX Virtual Firewall can be powered off and new SR-IOV adaptor can be added.

Use the following procedure to locate available VFs and add PCI devices:

#### 1. To locate one or more VFs:

- Use SSH to log in to the ESXi server and enter the following command to view the VFs for vmnic6 (or another vNIC):

```
# esxcli network sriovnic vf list -n vmnic6
```

VF ID	Active	PCI Address	Owner World ID
0	true	005:16.0	982641
1	true	005:16.2	982641
2	true	005:16.4	982641
3	false	005:16.6	-

```

4  false  005:17.0  -
5  false  005:17.2  -
6  false  005:17.4  -

```

Choose one or more VF IDs that are not active, such as 3 through 6. Note that a VF assigned to a VM that is powered off is shown as inactive.

- b. Enter the `lspci` command to view the VF number of the chosen VF IDs. In the following example, find the entry that ends with `[vmnic6]`, scroll down to the next entry ending in `VF_3`, and note the associated VF number `05:10.6`. Note that the next `VF_3` entry is for `vmnic7`.

```
# lspci
```

```

0000:05:00.0 Network controller: Intel Corporation 82599EB 10-Gig ... [vmnic6]
0000:05:00.1 Network controller: Intel Corporation 82599EB 10-Gig ... [vmnic7]
0000:05:10.0 Network controller: Intel Corporation 82599 Ethernet Controller Virtual
Function [PF_0.5.0_VF_0]
0000:05:10.1 Network controller: Intel Corporation 82599 Ethernet Controller Virtual
Function [PF_0.5.1_VF_0]
0000:05:10.2 Network controller: Intel Corporation 82599 Ethernet Controller Virtual
Function [PF_0.5.0_VF_1]
0000:05:10.3 Network controller: Intel Corporation 82599 Ethernet Controller Virtual
Function [PF_0.5.1_VF_1]
0000:05:10.4 Network controller: Intel Corporation 82599 Ethernet Controller Virtual
Function [PF_0.5.0_VF_2]
0000:05:10.5 Network controller: Intel Corporation 82599 Ethernet Controller Virtual
Function [PF_0.5.1_VF_2]
0000:05:10.6 Network controller: Intel Corporation 82599 Ethernet Controller Virtual
Function [PF_0.5.0_VF_3] ----- VF ID 3 on vmnic6, with VF number 05:10.6.
0000:05:10.7 Network controller: Intel Corporation 82599 Ethernet Controller Virtual
Function [PF_0.5.1_VF_3] ----- VF ID 3 on vmnic7.

```

## 2. To add SR-IOV interfaces to the vSRX Virtual Firewall VM:

- a. Power off the vSRX Virtual Firewall VM and open the Edit Settings page. By default there are three network adapters using VMXNET 3.
- b. Add one or more PCI devices on the Virtual Hardware page. For each device, you must select an entry with an available VF number from Step 1. For example:

**05:10.6 | Intel Corporation 82599 Ethernet Controller Virtual Function**

- c. Click **OK** and open the Edit Settings page to verify that the new network adapters are shown on the Virtual Hardware page (one VMXNET 3 network adapter and up to nine SR-IOV interfaces as PCI devices).

To view the SR-IOV interface MAC addresses, select the **VM Options** tab, click **Advanced** in the left frame, and then click **Edit Configuration**. In the parameters `pciPassthruN.generatedMACAddress`, `N` indicates the PCI device number (0 through 9).

- d. Power on the vSRX Virtual Firewall VM and log in to the VM to verify that VMXNET 3 network adapter 1 is mapped to `fxp0`, PCI device 0 is mapped to `ge-0/0/0`, PCI device 1 is mapped to `ge-0/0/1`, and so on.

**NOTE:** A vSRX Virtual Firewall VM with SR-IOV interfaces cannot be cloned. You must deploy a new vSRX Virtual Firewall VM and add the SR-IOV interfaces as described here.

## Add VMXNET 3 Interfaces

Use the following procedure to add VMXNET 3 interfaces:

1. Power off the vSRX Virtual Firewall VM and open the Edit Settings page on vSphere Web Client.
2. Add network adapters on the Virtual Hardware page. For each network adapter, select **Network** from New device list at the bottom of the page, expand **New Network**, and select **VMXNET 3** as the adapter type.
3. Click **OK** and open the Edit Settings page to verify that the new network adapters are shown on the Virtual Hardware page.
4. Power on the vSRX Virtual Firewall VM and log in to the VM to verify that network adapter 1 is mapped to `fxp0`, network adapter 2 is mapped to `ge-0/0/0`, and so on. Use the `show interfaces terse` CLI command to verify that the `fxp0` and `ge-0/0/n` interfaces are up.

## Upgrade a Multicore vSRX Virtual Firewall with VMware

### IN THIS SECTION

- [Power Down vSRX Virtual Firewall VM with VMware vSphere Web Client | 143](#)
- [Upgrade a Multicore vSRX Virtual Firewall with VMware vSphere Web Client | 143](#)
- [Optimize Performance of vSRX Virtual Firewall | 144](#)

Starting in Junos OS Release 15.1X49-70 and Junos OS Release 17.3R1, you can scale the performance and capacity of a vSRX Virtual Firewall instance by increasing the number of vCPUs and the amount of vRAM allocated to the vSRX Virtual Firewall. See *Requirements for vSRX on VMware* for the software requirement specifications of a vSRX Virtual Firewall VM.

**NOTE:** You cannot scale down the number of vCPUs or decrease the amount of vRAM for an existing vSRX Virtual Firewall VM.

## Power Down vSRX Virtual Firewall VM with VMware vSphere Web Client

In situations where you want to modify the vSRX Virtual Firewall VM XML file, you need to completely shut down vSRX Virtual Firewall and the associated VM.

To gracefully shutdown the vSRX Virtual Firewall instance with VMware vSphere Web Client:

1. Enter the vCenter server hostname or address in your browser (<https://<ipaddress>:9443>) to access the vSphere Web Client, and log in to the vCenter server with your credentials.
2. Check the vSRX Virtual Firewall VM you want to power off.
3. Select **Open Console** to open a console window to the vSRX Virtual Firewall VM.
4. From the vSRX Virtual Firewall console, reboot the vSRX Virtual Firewall instance.

```
vSRX# request system power-off.
```

## Upgrade a Multicore vSRX Virtual Firewall with VMware vSphere Web Client

You must power down the vSRX Virtual Firewall VM before you can update the vCPU and vRAM values for the VM.

To scale up the vSRX Virtual Firewall VM to a higher number of vCPUs or to an increased amount of vRAM:

1. On VMware vSphere Web Client, Select **Edit Settings** to open the powered down vSRX Virtual Firewall VM to open the virtual machine details window.
2. Select **Memory** and set the vRAM to the desired size.
3. Select **Processor** and set the number of vCPUs. Click **OK**.
4. Click **Power On**. The VM manager launches the vSRX Virtual Firewall VM with the new vCPU and vRAM settings.

**NOTE:** vSRX Virtual Firewall scales down to the closest supported value if the vCPU or vRAM settings do not match what is currently available.



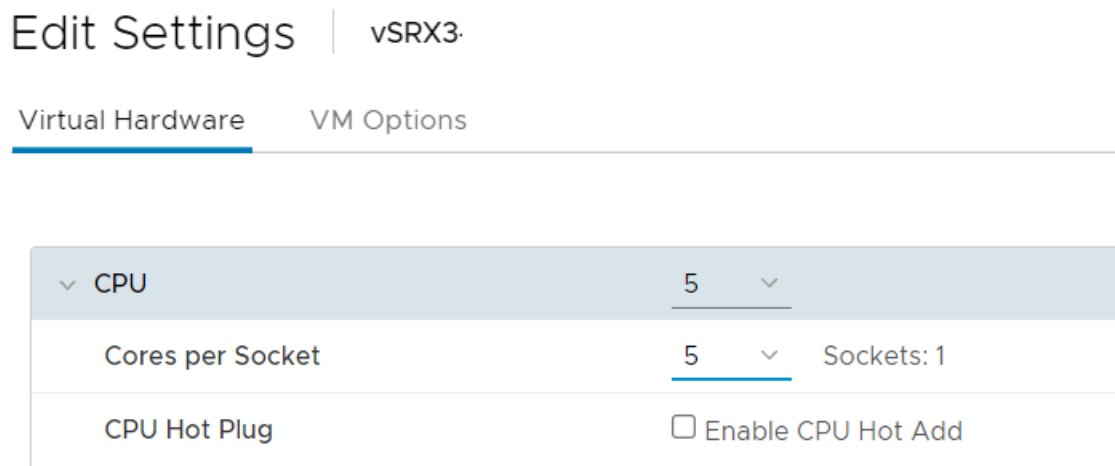
## Optimize Performance of vSRX Virtual Firewall

To optimize performance of vSRX Virtual Firewall on VMware:

1. For memory, select the NUMA node that line cards connect to.
2. For the CPU:
  - a. Disable hyper-threading.
  - b. Select CPUs on the selected NUMA node.
  - c. Set the number of CPUs to be assigned to the vSRX Virtual Firewall VM. Set the **Cores per socket** value in such a way that "Sockets: 1" is displayed as shown in *CPU Cores Per Socket*. This will force all CPU cores to be on the same NUMA node for optimized performance.

Under CPU, 'Cores per Socket' should be n, such that 'Sockets: 1'

**Figure 18: CPU Cores Per Socket**



- d. Reserve the CPU resource.
3. For the TX thread:
    - Configure a separate ESXi transmit thread per vNIC.
    - Place transmit threads on the same NUMA node.
  4. For vNICs, use either 2 vNICs or 4 vNICs if you want to scale the performance of the vSRX Virtual Firewall VM.

### Release History Table

Release	Description
15.1X49-D70	Starting in Junos OS Release 15.1X49-70 and Junos OS Release 17.3R1, you can scale the performance and capacity of a vSRX Virtual Firewall instance by increasing the number of vCPUs and the amount of vRAM allocated to the vSRX Virtual Firewall.

## Automate the Initialization of vSRX Virtual Firewall 3.0 Instances on VMware Hypervisor using VMware Tools

### IN THIS SECTION

- [Overview | 145](#)
- [Provision VMware Tools for Autoconfiguration | 146](#)

### Overview

#### IN THIS SECTION

- [Benefits of VMware Tools for Autoconfiguration | 146](#)

Open VM Tools is a set of services and modules that enhances the performance and user experience of vSRX Virtual Firewall. With this service, several features in VMware products are enabled for better management and easy user interactions with the guest OS. It includes kernel modules for enhancing the performance of virtual machines running Linux or other VMware-supported Unix-like guest operating systems. vSRX Virtual Firewall 3.0 supports VMware tools starting from Junos OS Release 20.2R1.

VMware Tools includes these components:

- VMware Tools Service
- VMware device Drivers
- VMware user process

- VMware Tools Control Panel

vSRX Virtual Firewall 3.0 runs on FreeBSD 11.x and later. FreeBSD 12 supports VMware open-vm-tools-10.3.0.

The VMware tools (binaries and libraries) are packaged into the vSRX Virtual Firewall image file and allow VM instances to query information from hypervisor and then set or use such information. by the VM instance itself.

During VM instance booting time, the boot-up script will look for Open Virtualization Format (OVF) settings or the machine ID setting. If the OVF settings are enabled, then the related VM CLI configurations are configured and the VM instance will use this CLI configuration when the VM instance is first powered on. We support autoconfiguration of hostname, IP address, gateway, DHCP, and DHCP server.

### **Benefits of VMware Tools for Autoconfiguration**

- Execute VMware-provided or user configured scripts in guest OS during various power operations.
- Collect network, disk, and memory usage information from the guest periodically.
- Generate heartbeat from guests to hosts to determine guests' availability.
- Enable Time synchronization between a host and guest
- Allows File transfer between a host and guest
- Provides improved memory management and network performance
- Supports general mechanisms and protocols for communication between host and guests and from guest to guest
- Allows you to customize guest operating systems immediately after powering on virtual machines.

### **Provision VMware Tools for Autoconfiguration**

There are 3 methods to make VMware tools support setting key-value are:

- Set the VM options of parameter machine ID for each key.
- Set vApp options of OVF property for each key.
- Edit the \*.ova package file to add the property for each key.

Use one of the methods to set the key-value.

If you want to change any VM parameters, use the VMware GUI. When VMWare hypervisor powers on the VM instance, open VMTool source code provides the functionality for the VM instance to query parameters from the hypervisor.

To set the VM options of parameter machine ID for settings keys:

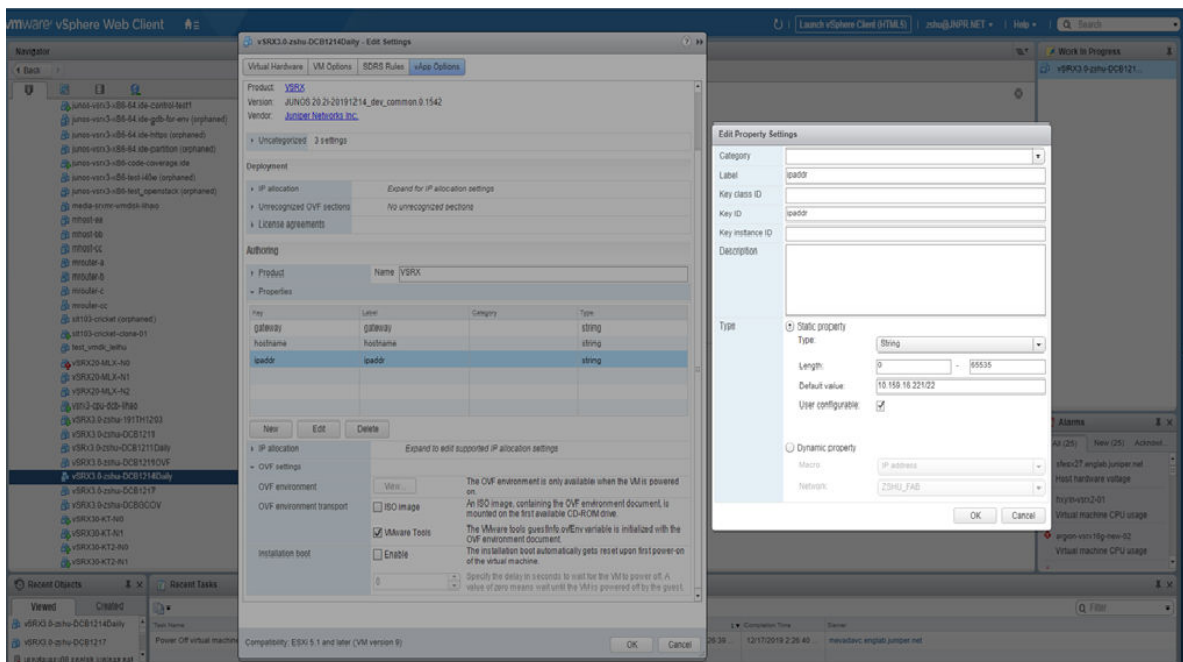
1. On the VMware ESXi vCenter server, access the VM on vSphere Web client (FLEX or HTML5), go to **Edit Virtual Machine Setting ->VM Options->Advanced**, and then on the **Configuration Parameters** tab, click **Edit Configuration**.
2. On the **Configuration Parameters** page, add a new parameter with **Name** and **Value** for each key.

**NOTE:** For fxp0 IP address configuration, you can configure a key-value pair with a set of IP address or gateway, a set of DHCP address or DHCP server, or both.

When dhcp=yes, and both IP address and dhcp-server is configured, then dhcp-server takes higher priority.

When dhcp=no, or dhcp is not configured, then even if both IP address and dhcp-server are set, then IP address takes higher priority.

Figure 19: OVF Property Settings



### Example: OVF Setting

- hostname: vSRX3.0-VMTOOL-Test

- ipaddr=10.159.16.221/22
- gateway= 10.159.16.2
- dhcp-server = 10.159.16.1
- dhcp=yes

**NOTE:** When deploy the VM with OVF setting, if you want to manually enter and provide the key-values at VMWare GUI, then providing one of IP address and dhcp server is enough. But, for packaging OVF settings, providing all five key-value pairs is better as you don't need to enter the five keys, and only need to modify the value.

Check the vSRX Virtual Firewall 3.0 login prompt for root ID without password and check the loaded configuration for the following:

- set system host-name vSRX3.0-VMTool-Test
- set interfaces fxp0 unit 0 family inet dhcp server-address 10.159.16.1

3. Add the parameter by selecting **Add** and then click **OK**.

4. Verify the configurations by validating the configurations on the instance, verify the configuration of fxp0 and default routes using the `show interfaces terse fxp0` command, or by checking the log files at `/var/log/setup_config.log`. Log files at `/var/log/setup_config.log` provide you the debugging messages, any syntax error, IP validation, the CLI configuration, and so on.

To set the vApp options of OVF property for each key:

1. On the VMware ESXi vCenter server, access the VM on vSphere Web client (FLEX), go to **Edit Virtual Machine Setting** -> **vApp Options**->**OVF setting**, and under **OVF environment transparent** tab , select **VMWare Tools**.
2. Go to **Edit Virtual Machine Setting**->**vApp Options**->**Properties** and edit each key value.
3. To verify the configuration login and power-on for the first time as root and without password, verify the fxp0 and DHCP bindings or check the log files at `/var/log/vmware_ovf.info` and `/var/log/setup_config.log`.

To edit the OVF package file instructions:

1. Untar the \*.ova. in the \*.ova file. There are three files: \*.ovf, \*.mf, and \*.vmdk.
2. Edit the \*.ovf file to add some property for each key value under the production section.

3. To verify the configuration, deploy the vSRX Virtual Firewall 3.0 from vCenter server Web client and check the properties set for each key value or check the log files at `/var/log/vmware_ovf.info` and `/var/log/setup_config.log`.

# Configure vSRX Virtual Firewall Chassis Clusters in VMware

## IN THIS CHAPTER

- [vSRX Virtual Firewall Cluster Staging and Provisioning for VMware | 150](#)
- [Configure a vSRX Virtual Firewall Chassis Cluster in Junos OS | 161](#)
- [Deploy vSRX Virtual Firewall Chassis Cluster Nodes Across Different ESXi Hosts Using dvSwitch | 174](#)

## vSRX Virtual Firewall Cluster Staging and Provisioning for VMware

### IN THIS SECTION

- [Deploying the VMs and Additional Network Interfaces | 150](#)
- [Creating the Control Link Connection Using VMware | 151](#)
- [Creating the Fabric Link Connection Using VMware | 155](#)
- [Creating the Data Interfaces Using VMware | 158](#)
- [Prestaging the Configuration from the Console | 159](#)
- [Connecting and Installing the Staging Configuration | 160](#)

Staging and provisioning a vSRX Virtual Firewall cluster includes the following tasks:

### Deploying the VMs and Additional Network Interfaces

The vSRX Virtual Firewall cluster uses three interfaces exclusively for clustering (the first two are predefined):

- Out-of-band management interface (fxp0).

- Cluster control link (em0).
- Cluster fabric links (fab0 and fab1). For example, you can specify ge-0/0/0 as fab0 on node0 and ge-7/0/0 as fab1 on node1.

Initially, the VM has only two interfaces. A cluster requires three interfaces (two for the cluster and one for management) and additional interfaces to forward data. You can add interfaces through the VMware vSphere Web Client.

1. On the VMware vSphere Web Client, click **Edit Virtual Machine Settings** for each VM to create additional interfaces.
2. Click **Add Hardware** and specify the attributes in [Table 28 on page 151](#).

**Table 28: Hardware Attributes**

Attribute	Description
Adapter Type	Select VMXNET 3 from the list.
Network label	Select the network label from the list.
Connect at power on	Ensure that there is a check mark next to this option.

## Creating the Control Link Connection Using VMware

To connect the control interface through the control vSwitch using the VMware vSphere Web Client:

1. Choose **Configuration > Networking**.
2. Click **Add Networking** to create a vSwitch for the control link.

Choose the following attributes:

- Connection Type
  - Virtual Machines
- Network Access
  - Create a vSphere switch
  - No physical adapters
- Port Group Properties
  - Network Label: HA Control



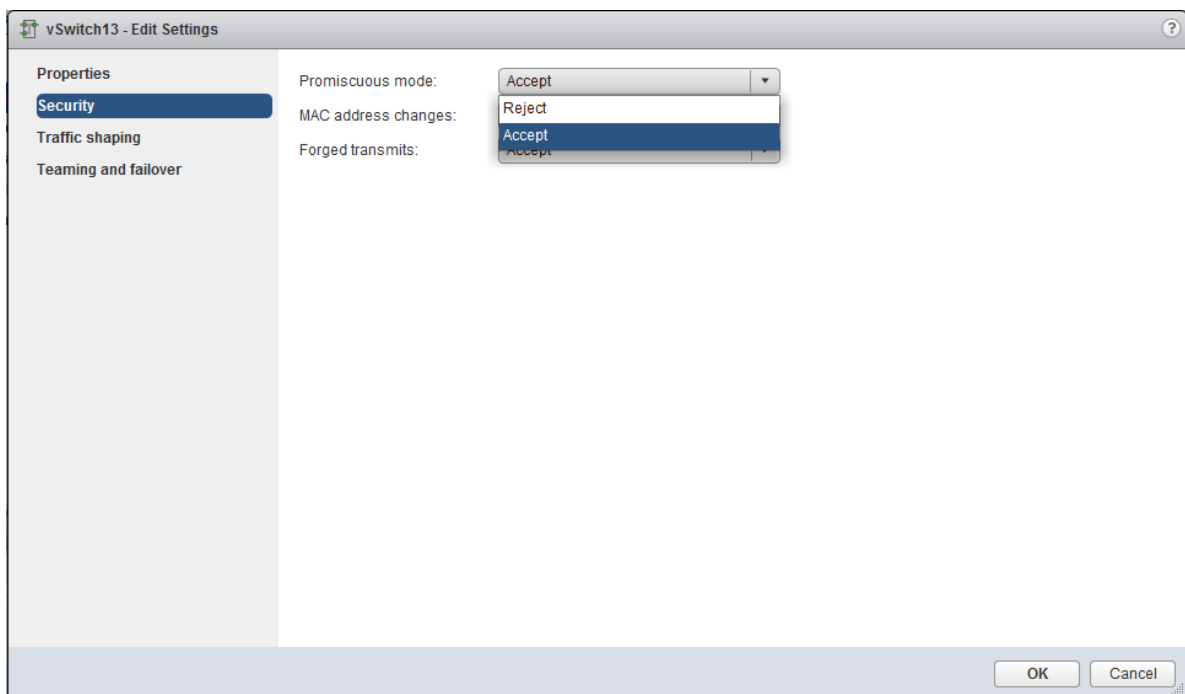
- VLAN ID: None(0)

**NOTE:** Port groups are not VLANs. The port group does not segment the vSwitch into separate broadcast domains unless the domains have different VLAN tags.

- To use a VLAN as a dedicated vSwitch, you can use the default VLAN tag (0) or specify a VLAN tag.
- To use a VLAN as a shared vSwitch and use a port group, assign a VLAN tag on the port group for each chassis cluster link.

3. Right-click on the control network, click **Edit Settings**, and select **Security**.
4. Set the promiscuous mode to **Accept**, and click **OK**, as shown in [Figure 20 on page 152](#).

**Figure 20: Promiscuous Mode**



**NOTE:** You must enable promiscuous mode on the control vSwitch for chassis cluster. You can use the vSwitch default settings for the remaining parameters.

5. Click **Edit Settings** for both vSRX Virtual Firewall VMs to add the control interface (Network adapter 2) into the control vSwitch.

See [Figure 21 on page 153](#) for vSwitch properties and [Figure 22 on page 154](#) for VM properties for the control vSwitch.

**Figure 21: Control vSwitch Properties**

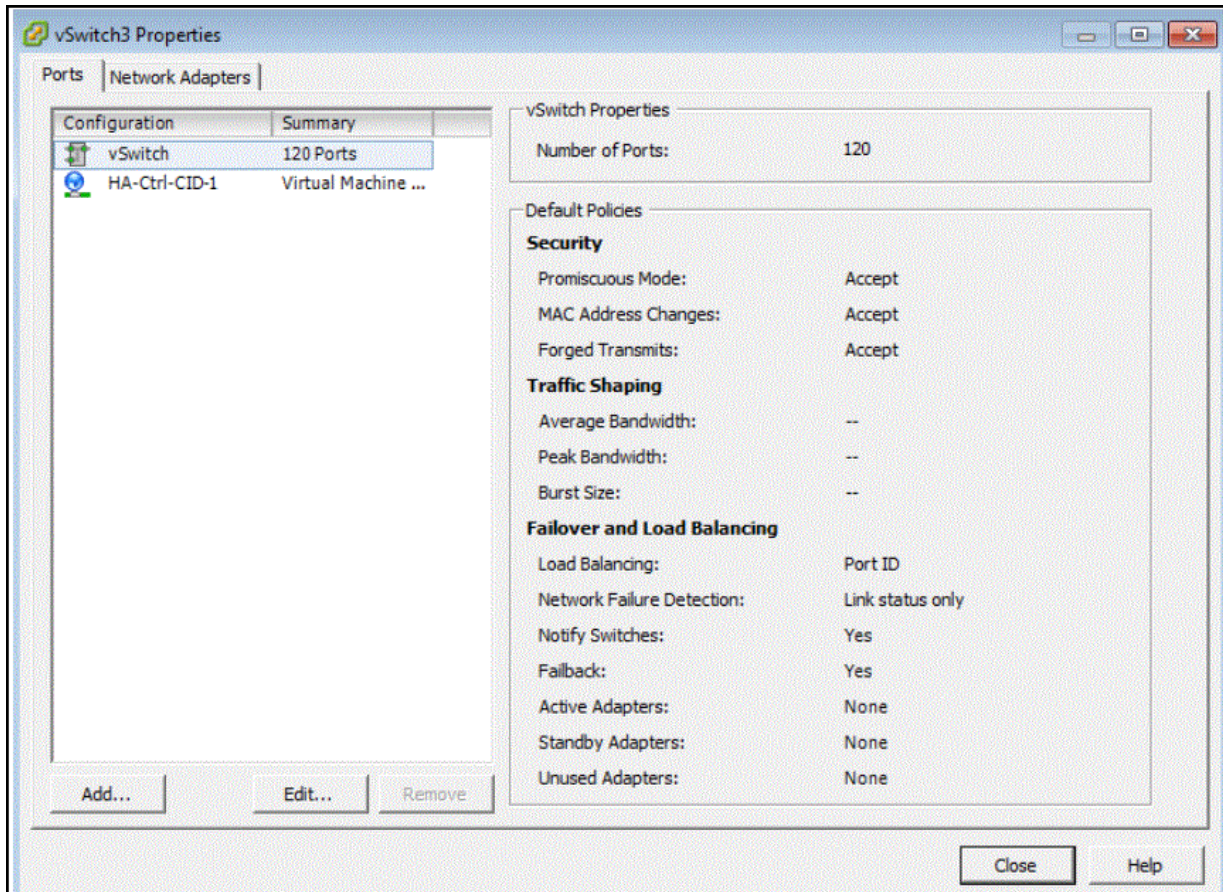
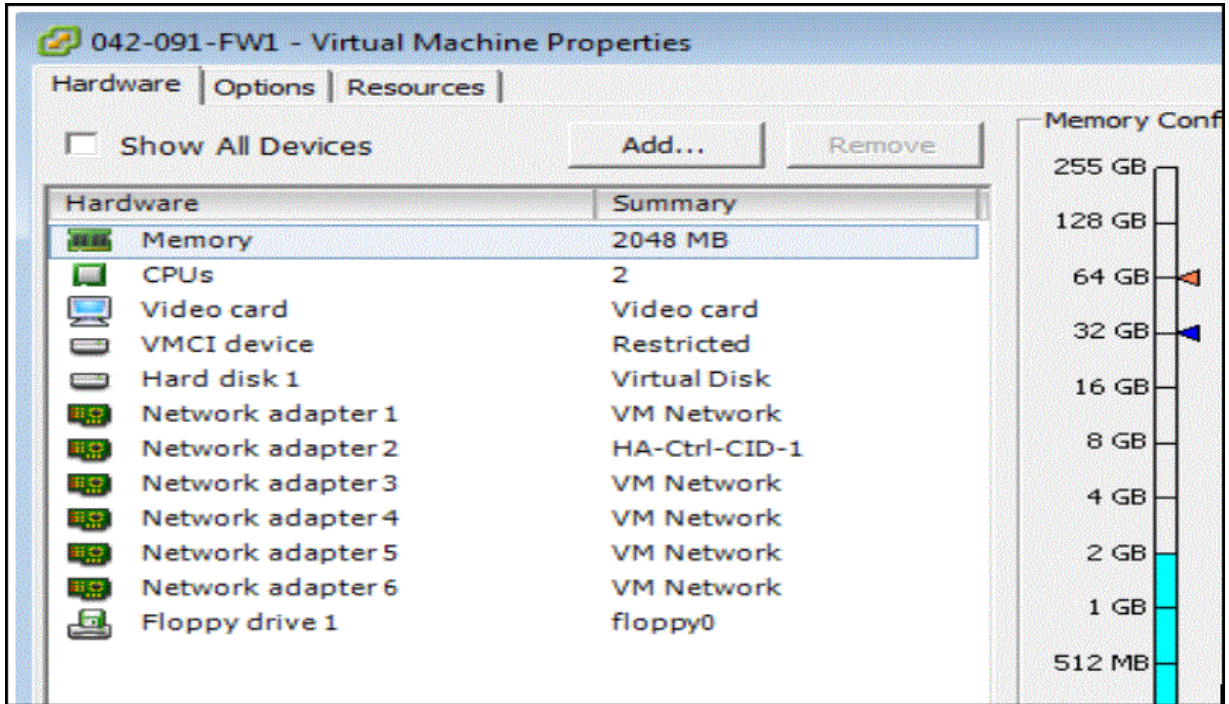
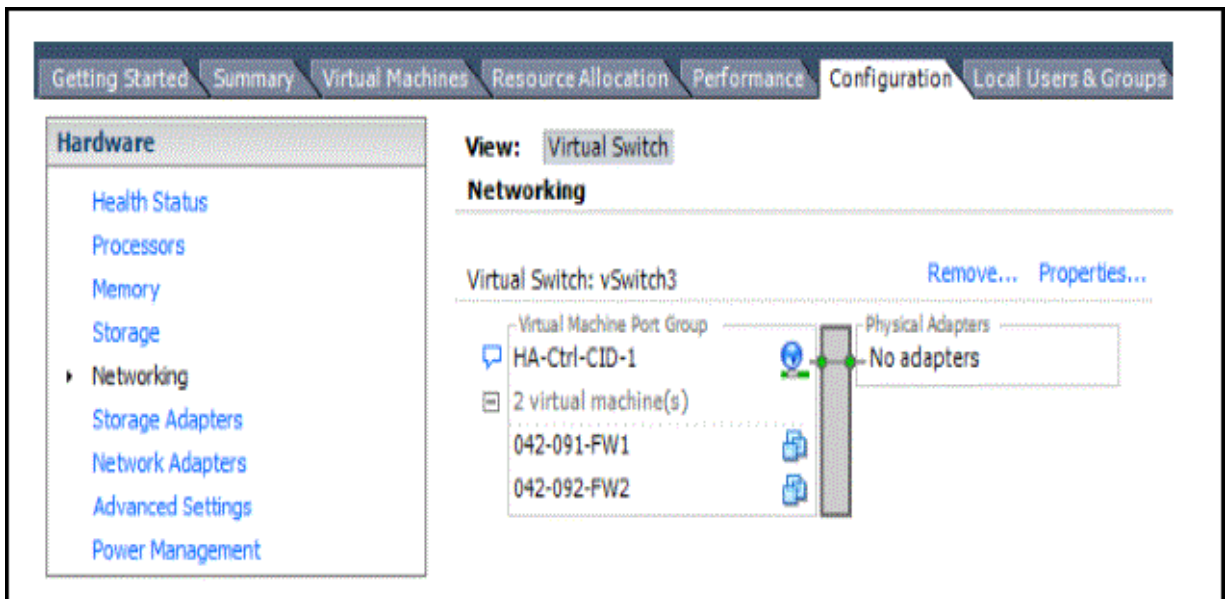


Figure 22: Virtual Machine Properties for the Control vSwitch



The control interface will be connected through the control vSwitch. See [Figure 23 on page 154](#).

Figure 23: Control Interface Connected through the Control vSwitch



## Creating the Fabric Link Connection Using VMware

To connect the fabric interface through the fabric vSwitch using the VMware vSphere Web Client:

1. Choose **Configuration > Networking**.
2. Click **Add Networking** to create a vSwitch for the fabric link.

Choose the following attributes:

- Connection Type
  - Virtual Machines
- Network Access
  - Create a vSphere switch
  - No physical adapters
- Port Group Properties
  - Network Label: HA Fabric
  - VLAN ID: None(0)

**NOTE:** Port groups are not VLANs. The port group does not segment the vSwitch into separate broadcast domains unless the domains have different VLAN tags.

- To use a VLAN as a dedicated vSwitch, you can use the default VLAN tag (0) or specify a VLAN tag.
- To use VLAN as a shared vSwitch and use a port group, assign a VLAN tag on the port group for each chassis cluster link.

Click **Properties** to enable the following features:

- **General-> Advanced Properties:**
    - MTU: 9000
  - **Security-> Effective Polices:**
    - MAC Address Changes: Accept
    - Forged Transmits: Accept
3. Click **Edit Settings** for both vSRX Virtual Firewall VMs to add the fabric interface into the fabric vSwitch.

See [Figure 24 on page 156](#) for vSwitch properties and [Figure 25 on page 157](#) for VM properties for the fabric vSwitch.

**Figure 24: Fabric vSwitch Properties**

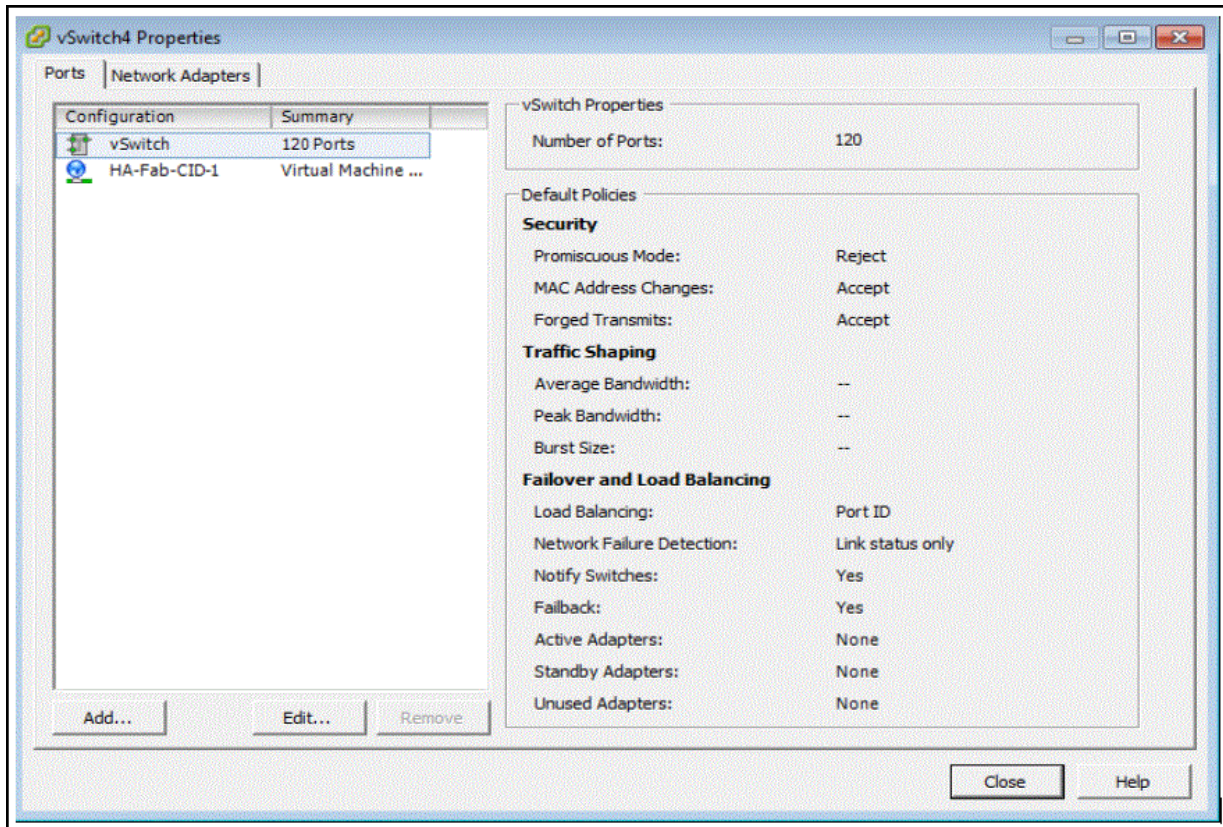
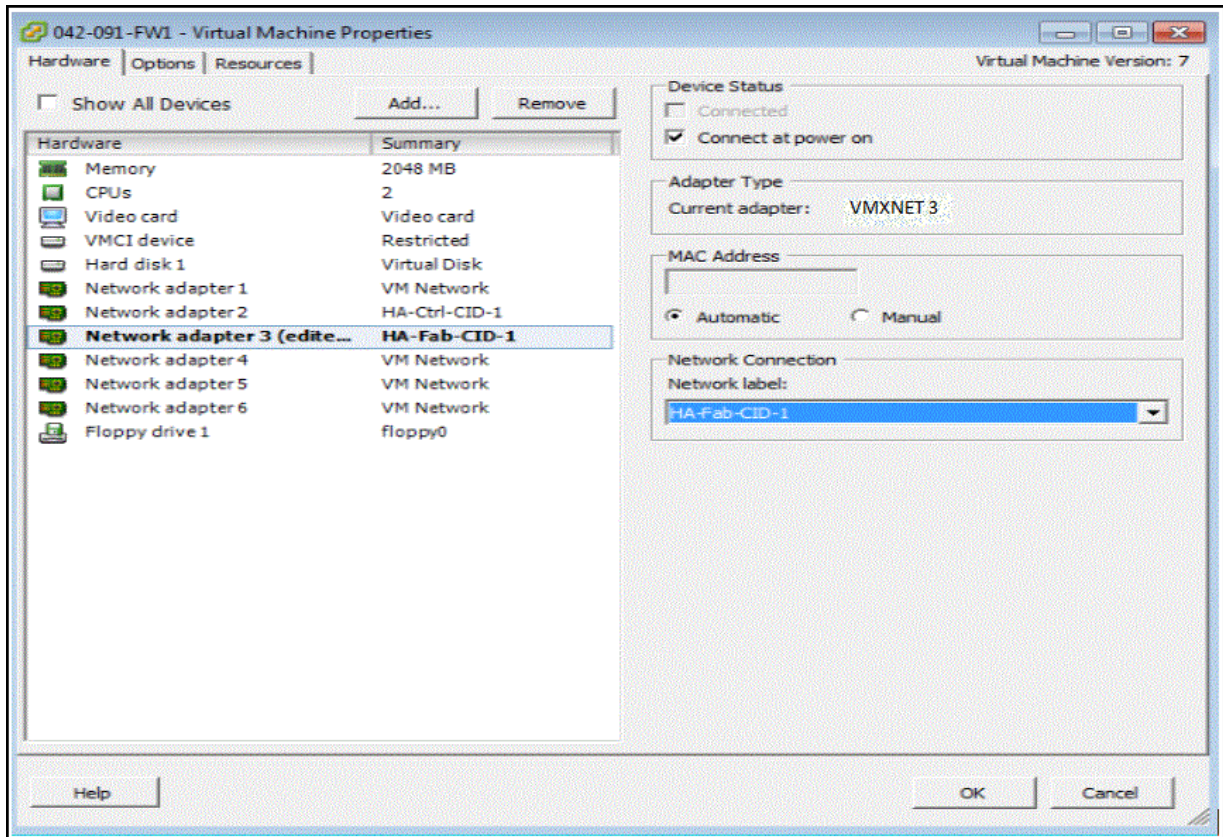
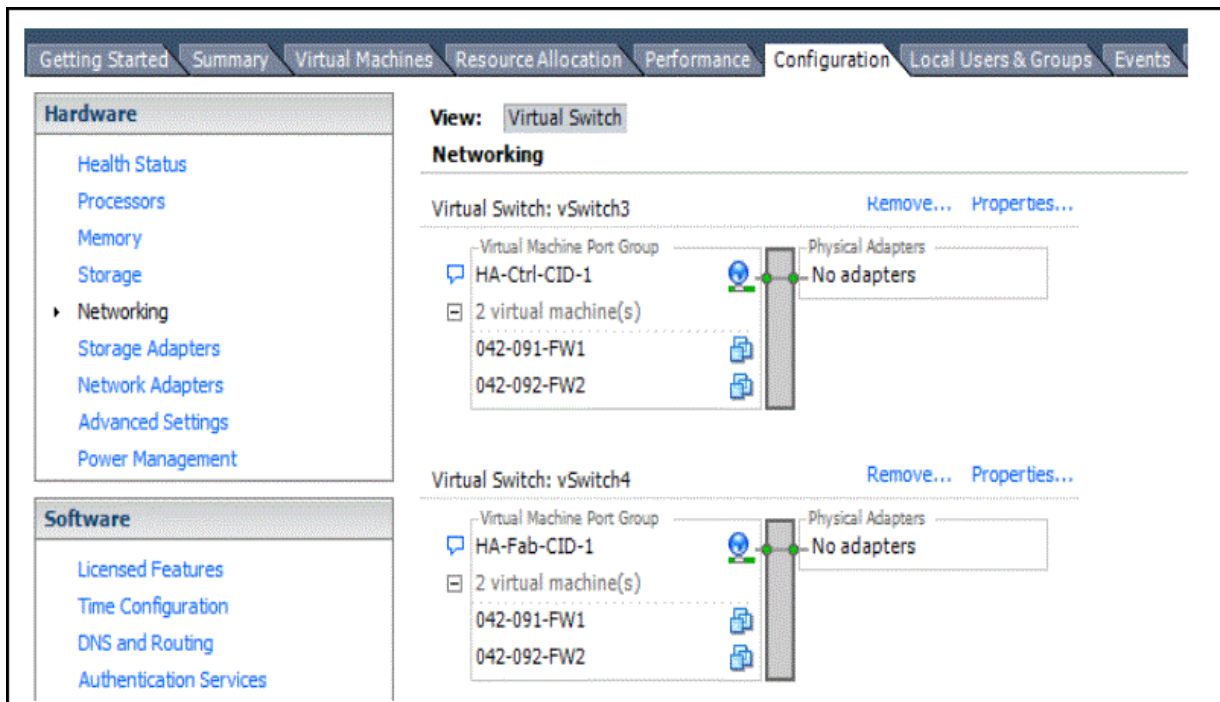


Figure 25: Virtual Machine Properties for the Fabric vSwitch



The fabric interface will be connected through the fabric vSwitch. See [Figure 26 on page 158](#).

Figure 26: Fabric Interface Connected Through the Fabric vSwitch



## Creating the Data Interfaces Using VMware

To map all the data interfaces to the desired networks:

1. Choose **Configuration > Networking**.
2. Click **Add Networking** to create a vSwitch for fabric link.

Choose the following attributes:

- Connection Type
  - Virtual Machines
- Network Access
  - Create a vSphere switch
  - No physical adapters
- Port Group Properties
  - Network Label: chassis cluster Reth
  - VLAN ID: None(0)

Click **Properties** to enable the following features:

- **Security-> Effective Polices:**
  - MAC Address Changes: Accept
  - Forged Transmits: Accept

The data interface will be connected through the data vSwitch using the above procedure.

## Prestaging the Configuration from the Console

The following procedure explains the configuration commands required to set up the vSRX Virtual Firewall chassis cluster. The procedure powers up both nodes, adds the configuration to the cluster, and allows SSH remote access.

1. Log in as the root user. There is no password.
2. Start the CLI.

```
root#cli
root@>
```

3. Enter configuration mode.

```
configure
[edit]
root@#
```

4. Copy the following commands and paste them into the CLI:

```
set groups node0 interfaces fxp0 unit 0 family inet address 192.168.42.81/24
set groups node0 system hostname vsrx-node0
set groups node1 interfaces fxp0 unit 0 family inet address 192.168.42.82/24
set groups node1 system hostname vsrx-node1
set apply-groups "${node}"
```

5. Set the root authentication password by entering a cleartext password, an encrypted password, or an SSH public key string (DSA or RSA).

```
root@# set system root-authentication plain-text-password
New password: password
Retype new password: password
set system root-authentication encrypted-password "$ABC123"
```



6. To enable SSH remote access:

```
user@host#set system services ssh
```

7. To enable IPv6:

```
user@host#set security forwarding-options family inet6 mode flow-based
```

This step is optional and requires a system reboot.

8. Commit the configuration to activate it on the device.

```
user@host#commit
commit complete
```

9. When you have finished configuring the device, exit configuration mode.

```
user@host#exit
```

## Connecting and Installing the Staging Configuration

After the vSRX Virtual Firewall cluster initial setup, set the cluster ID and the node ID, as described in *Configure a vSRX Chassis Cluster in Junos OS*.

After reboot, the two nodes are reachable on interface fxp0 with SSH. If the configuration is operational, the `show chassis cluster status` command displays output similar to that shown in the following sample output.

```
vSRX Virtual Firewall> show chassis cluster status
```

```
Cluster ID: 1
Node           Priority      Status    Preempt  Manual failover

Redundancy group: 0 , Failover count: 1
  node0         100          secondary no        no
  node1         150          primary  no        no

Redundancy group: 1 , Failover count: 1
```

node0	100	secondary	no	no
node1	150	primary	no	no

A cluster is healthy when the primary and secondary nodes are present and both have a priority greater than 0.

## Configure a vSRX Virtual Firewall Chassis Cluster in Junos OS

### IN THIS SECTION

- [Chassis Cluster Overview | 161](#)
- [Enable Chassis Cluster Formation | 162](#)
- [Chassis Cluster Quick Setup with J-Web | 167](#)
- [Manually Configure a Chassis Cluster with J-Web | 168](#)

### Chassis Cluster Overview

*Chassis cluster* groups a pair of the same kind of vSRX Virtual Firewall instances into a cluster to provide network node redundancy. The devices must be running the same Junos OS release. You connect the control virtual interfaces on the respective nodes to form a *control plane* that synchronizes the configuration and Junos OS kernel state. The control link (a *virtual network* or *vSwitch*) facilitates the redundancy of interfaces and services. Similarly, you connect the *data plane* on the respective nodes over the fabric virtual interfaces to form a unified data plane. The fabric link (a virtual network or vSwitch) allows for the management of cross-node flow processing and for the management of session redundancy.

The control plane software operates in active/passive mode. When configured as a chassis cluster, one node acts as the primary device and the other as the secondary device to ensure stateful failover of processes and services in the event of a system or hardware failure on the primary device. If the primary device fails, the secondary device takes over processing of control plane traffic.

**NOTE:** If you configure a chassis cluster on vSRX Virtual Firewall nodes across two physical hosts, disable igmp-snooping on the bridge that each host physical interface belongs to that the control vNICs use. This ensures that the control link heartbeat is received by both nodes in the chassis cluster.

The chassis cluster data plane operates in active/active mode. In a chassis cluster, the data plane updates session information as traffic traverses either device, and it transmits information between the nodes over the fabric link to guarantee that established sessions are not dropped when a failover occurs. In active/active mode, traffic can enter the cluster on one node and exit from the other node.

Chassis cluster functionality includes:

- Resilient system architecture, with a single active control plane for the entire cluster and multiple *Packet Forwarding Engines*. This architecture presents a single device view of the cluster.
- Synchronization of configuration and dynamic runtime states between nodes within a cluster.
- Monitoring of physical interfaces, and failover if the failure parameters cross a configured threshold.
- Support for generic routing encapsulation (*GRE*) and IP-over-IP (IP-IP) tunnels used to route encapsulated IPv4 or *IPv6* traffic by means of two internal interfaces, *gr-0/0/0* and *ip-0/0/0*, respectively. Junos OS creates these interfaces at system startup and uses these interfaces only for processing GRE and IP-IP tunnels.

At any given instant, a cluster node can be in one of the following states: hold, primary, secondary-hold, secondary, ineligible, or disabled. Multiple event types, such as interface monitoring, Services Processing Unit (SPU) monitoring, failures, and manual failovers, can trigger a state transition.

## Enable Chassis Cluster Formation

### IN THIS SECTION

- [Chassis Cluster Provisioning on vSRX Virtual Firewall | 162](#)
- [Interface Naming and Mapping | 164](#)
- [Enabling Chassis Cluster Formation | 166](#)

### Chassis Cluster Provisioning on vSRX Virtual Firewall

Setting up the connectivity for chassis cluster on vSRX Virtual Firewall instances is similar to physical SRX Series Firewalls. The vSRX Virtual Firewall VM uses virtual network (or vswitch) for virtual NIC (such as VMXNET3 or virtio).

Chassis cluster requires the following direct connections between the two vSRX Virtual Firewall instances:

- Control link, or virtual network, which acts in active/passive mode for the control plane traffic between the two vSRX Virtual Firewall instances

- Fabric link, or virtual network, which is used for real-time session synchronization between the nodes. In active/active mode, this link is also used for carrying data traffic between the two vSRX Virtual Firewall instances.

**NOTE:** Note: You can optionally create two fabric links for more redundancy.

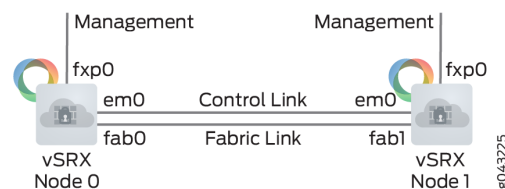
The vSRX Virtual Firewall cluster uses the following interfaces:

- Out-of-band Management interface (fxp0)
- Cluster control interface (em0)
- Cluster fabric interface (fab0 on node0, fab1 on node1)

**NOTE:** The control interface must be the second vNIC. For the fabric link you can use any revenue port (ge- ports). You can optionally configure a second fabric link for increased redundancy.

Figure 27 on page 163 shows chassis cluster formation with vSRX Virtual Firewall instances.

**Figure 27: vSRX Virtual Firewall Chassis Cluster**



vSRX Virtual Firewall supports chassis cluster using the virtio driver and SR-IOV interfaces, with the following considerations:

- When you enable chassis cluster, you must also enable jumbo frames (MTU size = 9000) to support the fabric link on the virtio network interface.
- If you configure a chassis cluster across two physical hosts, disable igmp-snooping on each host physical interface that the vSRX Virtual Firewall control link uses to ensure that the control link heartbeat is received by both nodes in the chassis cluster.

```
host0S# echo 0 > /sys/devices/virtual/net/<bridge-name>/bridge/multicast_snooping
```

- After chassis cluster is enabled, the vSRX Virtual Firewall instance maps the second vNIC to the control link automatically, and its name will be changed from ge-0/0/0 to em0.

- You can use any other vNICs for the fabric link/links. (See ["Interface Naming and Mapping" on page 164](#))

For virtio interfaces, link status update is not supported. The link status of virtio interfaces is always reported as Up. For this reason, a vSRX Virtual Firewall instance using virtio and chassis cluster cannot receive link up and link down messages from virtio interfaces.

The virtual network MAC aging time determines the amount of time that an entry remains in the MAC table. We recommend that you reduce the MAC aging time on the virtual networks to minimize the downtime during failover.

For example, you can use the `brctl setageing bridge 1` command to set aging to 1 second for the Linux bridge.

You configure the virtual networks for the control and fabric links, then create and connect the control interface to the control virtual network and the fabric interface to the fabric virtual network.

### Interface Naming and Mapping

Each network adapter defined for a vSRX Virtual Firewall is mapped to a specific interface, depending on whether the vSRX Virtual Firewall instance is a standalone VM or one of a cluster pair for high availability. The interface names and mappings in vSRX Virtual Firewall are shown in Table 1 and Table 2.

Note the following:

- In standalone mode:
  - `fxp0` is the out-of-band management interface.
  - `ge-0/0/0` is the first traffic (revenue) interface.
- In cluster mode:
  - `fxp0` is the out-of-band management interface.
  - `em0` is the cluster control link for both nodes.
  - Any of the traffic interfaces can be specified as the fabric links, such as `ge-0/0/0` for `fab0` on node 0 and `ge-7/0/0` for `fab1` on node 1.

The interface names and mappings for a standalone vSRX Virtual Firewall VM can be seen in [Table 29 on page 165](#) and for a vSRX Virtual Firewall VM in cluster mode the same is shown in [Table 30 on page 165](#). You can see that in the cluster mode, the `em0` port is inserted between the `fxp0` and `ge-0/0/0` positions, which makes the revenue port numbers shift up one vNIC location.

**Table 29: Interface Names for a Standalone vSRX Virtual Firewall VM**

Network Adapter	Interface Names
1	fxp0
2	ge-0/0/0
3	ge-0/0/1
4	ge-0/0/2
5	ge-0/0/3
6	ge-0/0/4
7	ge-0/0/5
8	ge-0/0/6

**Table 30: Interface Names for a vSRX Virtual Firewall Cluster Pair**

Network Adapter	Interface Names
1	fxp0 (node 0 and 1)
2	em0 (node 0 and 1)
3	ge-0/0/0 (node 0) ge-7/0/0 (node 1)
4	ge-0/0/1 (node 0) ge-7/0/1 (node 1)

Table 30: Interface Names for a vSRX Virtual Firewall Cluster Pair (*Continued*)

Network Adapter	Interface Names
5	ge-0/0/2 (node 0) ge-7/0/2 (node 1)
6	ge-0/0/3 (node 0) ge-7/0/3 (node 1)
7	ge-0/0/4 (node 0) ge-7/0/4 (node 1)
8	ge-0/0/5 (node 0) ge-7/0/5 (node 1)

### Enabling Chassis Cluster Formation

You create two vSRX Virtual Firewall instances to form a chassis cluster, and then you set the cluster ID and node ID on each instance to join the cluster. When a vSRX Virtual Firewall VM joins a cluster, it becomes a node of that cluster. With the exception of unique node settings and management IP addresses, nodes in a cluster share the same configuration.

You can deploy up to 255 chassis clusters in a *Layer 2* domain. Clusters and nodes are identified in the following ways:

- The *cluster ID* (a number from 1 to 255) identifies the cluster.
- The *node ID* (a number from 0 to 1) identifies the cluster node.

On SRX Series Firewalls, the cluster ID and node ID are written into EEPROM. On the vSRX Virtual Firewall VM, vSRX Virtual Firewall stores and reads the IDs from **boot/loader.conf** and uses the IDs to initialize the chassis cluster during startup.

Ensure that your vSRX Virtual Firewall instances comply with the following prerequisites before you enable chassis clustering:

- You have committed a basic configuration to both vSRX Virtual Firewall instances that form the chassis cluster. See [Configuring vSRX Using the CLI](#).

- Use `show version` in Junos OS to ensure that both vSRX Virtual Firewall instances have the same software version.
- Use `show system license` in Junos OS to ensure that both vSRX Virtual Firewall instances have the same licenses installed.
- You must set the same chassis cluster ID on each vSRX Virtual Firewall node and reboot the vSRX Virtual Firewall VM to enable chassis cluster formation.

The chassis cluster formation commands for node 0 and node 1 are as follows:

- On vSRX Virtual Firewall node 0:

```
user@vsrx0>set chassis cluster cluster-id number node 0 reboot
```

- On vSRX Virtual Firewall node 1:

```
user@vsrx1>set chassis cluster cluster-id number node 1 reboot
```

The vSRX Virtual Firewall interface naming and mapping to vNICs changes when you enable chassis clustering. Use the same cluster ID number for each node in the cluster.

**NOTE:** When using multiple clusters that are connected to the same L2 domain, a unique cluster-id needs to be used for each cluster. Otherwise you may get duplicate mac addresses on the network, because the cluster-id is used to form the virtual interface mac addresses.

After reboot, on node 0, configure the fabric (data) ports of the cluster that are used to pass real-time objects (RTOs):

- ```
user@vsrx0# set interfaces fab0 fabric-options member-interfaces ge-0/0/0
```

```
user@vsrx0# set interfaces fab1 fabric-options member-interfaces ge-7/0/0
```

## Chassis Cluster Quick Setup with J-Web

To configure chassis cluster from *J-Web*:

1. Enter the vSRX Virtual Firewall node 0 interface IP address in a Web browser.
2. Enter the vSRX Virtual Firewall username and password, and click **Log In**. The J-Web dashboard appears.



3. Click **Configuration Wizards>Chassis Cluster** from the left panel. The Chassis Cluster Setup wizard appears. Follow the steps in the setup wizard to configure the cluster ID and the two nodes in the cluster, and to verify connectivity.

**NOTE:** Use the built-in Help icon in J-Web for further details on the Chassis Cluster Setup wizard.

## Manually Configure a Chassis Cluster with J-Web

You can use the *J-Web* interface to configure the primary node 0 vSRX Virtual Firewall instance in the cluster. Once you have set the cluster and node IDs and rebooted each vSRX Virtual Firewall, the following configuration will automatically be synced to the secondary node 1 vSRX Virtual Firewall instance.

Select **Configure>Chassis Cluster>Cluster Configuration**. The Chassis Cluster configuration page appears.

[Table 31 on page 168](#) explains the contents of the HA Cluster Settings tab.

[Table 32 on page 170](#) explains how to edit the Node Settings tab.

[Table 33 on page 171](#) explains how to add or edit the HA Cluster Interfaces table.

[Table 34 on page 172](#) explains how to add or edit the HA Cluster Redundancy Groups table.

**Table 31: Chassis Cluster Configuration Page**

| Field                | Function                                                                                                                          |
|----------------------|-----------------------------------------------------------------------------------------------------------------------------------|
| <b>Node Settings</b> |                                                                                                                                   |
| Node ID              | Displays the node ID.                                                                                                             |
| Cluster ID           | Displays the cluster ID configured for the node.                                                                                  |
| Host Name            | Displays the name of the node.                                                                                                    |
| Backup Router        | Displays the router used as a gateway while the Routing Engine is in secondary state for redundancy-group 0 in a chassis cluster. |

Table 31: Chassis Cluster Configuration Page (*Continued*)

| Field                | Function                                                                                                                                                                                            |
|----------------------|-----------------------------------------------------------------------------------------------------------------------------------------------------------------------------------------------------|
| Management Interface | Displays the management interface of the node.                                                                                                                                                      |
| IP Address           | Displays the management IP address of the node.                                                                                                                                                     |
| Status               | Displays the state of the redundancy group. <ul style="list-style-type: none"> <li>• <b>Primary</b>–Redundancy group is active.</li> <li>• <b>Secondary</b>–Redundancy group is passive.</li> </ul> |

#### Chassis Cluster>HA Cluster Settings>Interfaces

|                              |                                                                               |
|------------------------------|-------------------------------------------------------------------------------|
| Name                         | Displays the physical interface name.                                         |
| Member Interfaces/IP Address | Displays the member interface name or IP address configured for an interface. |
| Redundancy Group             | Displays the redundancy group.                                                |

#### Chassis Cluster>HA Cluster Settings>Redundancy Group

|                      |                                                                                                                                                                                                                                    |
|----------------------|------------------------------------------------------------------------------------------------------------------------------------------------------------------------------------------------------------------------------------|
| Group                | Displays the redundancy group identification number.                                                                                                                                                                               |
| Preempt              | Displays the selected preempt option. <ul style="list-style-type: none"> <li>• <b>True</b>–Primary Role can be preempted based on priority.</li> <li>• <b>False</b>–Primary Role cannot be preempted based on priority.</li> </ul> |
| Gratuitous ARP Count | Displays the number of gratuitous Address Resolution Protocol ( <i>ARP</i> ) requests that a newly elected primary device in a chassis cluster sends out to announce its presence to the other network devices.                    |

Table 31: Chassis Cluster Configuration Page (*Continued*)

| Field         | Function                                                                                                                                                         |
|---------------|------------------------------------------------------------------------------------------------------------------------------------------------------------------|
| Node Priority | Displays the assigned priority for the redundancy group on that node. The eligible node with the highest priority is elected as primary for the redundant group. |

Table 32: Edit Node Setting Configuration Details

| Field                | Function                                                                                                                              | Action                                     |
|----------------------|---------------------------------------------------------------------------------------------------------------------------------------|--------------------------------------------|
| <b>Node Settings</b> |                                                                                                                                       |                                            |
| Host Name            | Specifies the name of the host.                                                                                                       | Enter the name of the host.                |
| Backup Router        | Displays the device used as a gateway while the Routing Engine is in the secondary state for redundancy-group 0 in a chassis cluster. | Enter the IP address of the backup router. |
| <b>Destination</b>   |                                                                                                                                       |                                            |
| IP                   | Adds the destination address.                                                                                                         | Click <b>Add</b> .                         |
| Delete               | Deletes the destination address.                                                                                                      | Click <b>Delete</b> .                      |
| <b>Interface</b>     |                                                                                                                                       |                                            |
| Interface            | Specifies the interfaces available for the router.<br><b>NOTE:</b> Allows you to add and edit two interfaces for each fabric link.    | Select an option.                          |
| IP                   | Specifies the interface IP address.                                                                                                   | Enter the interface IP address.            |
| Add                  | Adds the interface.                                                                                                                   | Click <b>Add</b> .                         |

Table 32: Edit Node Setting Configuration Details (Continued)

| Field  | Function               | Action                |
|--------|------------------------|-----------------------|
| Delete | Deletes the interface. | Click <b>Delete</b> . |

Table 33: Add HA Cluster Interface Configuration Details

| Field | Function | Action |
|-------|----------|--------|
|-------|----------|--------|

**Fabric Link > Fabric Link 0 (fab0)**

|           |                             |                                       |
|-----------|-----------------------------|---------------------------------------|
| Interface | Specifies fabric link 0.    | Enter the interface IP fabric link 0. |
| Add       | Adds fabric interface 0.    | Click <b>Add</b> .                    |
| Delete    | Deletes fabric interface 0. | Click <b>Delete</b> .                 |

**Fabric Link > Fabric Link 1 (fab1)**

|           |                             |                                           |
|-----------|-----------------------------|-------------------------------------------|
| Interface | Specifies fabric link 1.    | Enter the interface IP for fabric link 1. |
| Add       | Adds fabric interface 1.    | Click <b>Add</b> .                        |
| Delete    | Deletes fabric interface 1. | Click <b>Delete</b> .                     |

**Redundant Ethernet**

|                  |                                                                                                    |                                          |
|------------------|----------------------------------------------------------------------------------------------------|------------------------------------------|
| Interface        | Specifies a logical interface consisting of two physical Ethernet interfaces, one on each chassis. | Enter the logical interface.             |
| IP               | Specifies a redundant Ethernet IP address.                                                         | Enter a redundant Ethernet IP address.   |
| Redundancy Group | Specifies the redundancy group ID number in the chassis cluster.                                   | Select a redundancy group from the list. |

Table 33: Add HA Cluster Interface Configuration Details (*Continued*)

| Field  | Function                                 | Action                |
|--------|------------------------------------------|-----------------------|
| Add    | Adds a redundant Ethernet IP address.    | Click <b>Add</b> .    |
| Delete | Deletes a redundant Ethernet IP address. | Click <b>Delete</b> . |

Table 34: Add Redundancy Groups Configuration Details

| Field                           | Function                                                                                                                                                                                                                                                                                                                                                         | Action                                        |
|---------------------------------|------------------------------------------------------------------------------------------------------------------------------------------------------------------------------------------------------------------------------------------------------------------------------------------------------------------------------------------------------------------|-----------------------------------------------|
| Redundancy Group                | Specifies the redundancy group name.                                                                                                                                                                                                                                                                                                                             | Enter the redundancy group name.              |
| Allow preemption of primaryship | Allows a node with a better priority to initiate a failover for a redundancy group.<br><br><b>NOTE:</b> By default, this feature is disabled. When disabled, a node with a better priority does not initiate a redundancy group failover (unless some other factor, such as faulty network connectivity identified for monitored interfaces, causes a failover). | –                                             |
| Gratuitous ARP Count            | Specifies the number of gratuitous Address Resolution Protocol requests that a newly elected primary sends out on the active redundant Ethernet interface child links to notify network devices of a change in primary role on the redundant Ethernet interface links.                                                                                           | Enter a value from 1 to 16. The default is 4. |
| node0 priority                  | Specifies the priority value of node0 for a redundancy group.                                                                                                                                                                                                                                                                                                    | Enter the node priority number as 0.          |
| node1 priority                  | Specifies the priority value of node1 for a redundancy group.                                                                                                                                                                                                                                                                                                    | Select the node priority number as 1.         |
| <b>Interface Monitor</b>        |                                                                                                                                                                                                                                                                                                                                                                  |                                               |

Table 34: Add Redundancy Groups Configuration Details (*Continued*)

| Field     | Function                                                                                        | Action                                                                  |
|-----------|-------------------------------------------------------------------------------------------------|-------------------------------------------------------------------------|
| Interface | Specifies the number of redundant Ethernet interfaces to be created for the cluster.            | Select an interface from the list.                                      |
| Weight    | Specifies the weight for the interface to be monitored.                                         | Enter a value from 1 to 125.                                            |
| Add       | Adds interfaces to be monitored by the redundancy group along with their respective weights.    | Click <b>Add</b> .                                                      |
| Delete    | Deletes interfaces to be monitored by the redundancy group along with their respective weights. | Select the interface from the configured list and click <b>Delete</b> . |

#### IP Monitoring

|                |                                                                         |                              |
|----------------|-------------------------------------------------------------------------|------------------------------|
| Weight         | Specifies the global weight for IP monitoring.                          | Enter a value from 0 to 255. |
| Threshold      | Specifies the global threshold for IP monitoring.                       | Enter a value from 0 to 255. |
| Retry Count    | Specifies the number of retries needed to declare reachability failure. | Enter a value from 5 to 15.  |
| Retry Interval | Specifies the time interval in seconds between retries.                 | Enter a value from 1 to 30.  |

#### IPv4 Addresses to Be Monitored

|        |                                                                          |                           |
|--------|--------------------------------------------------------------------------|---------------------------|
| IP     | Specifies the IPv4 addresses to be monitored for reachability.           | Enter the IPv4 addresses. |
| Weight | Specifies the weight for the redundancy group interface to be monitored. | Enter the weight.         |

**Table 34: Add Redundancy Groups Configuration Details (Continued)**

| Field                | Function                                                                  | Action                                                          |
|----------------------|---------------------------------------------------------------------------|-----------------------------------------------------------------|
| Interface            | Specifies the logical interface through which to monitor this IP address. | Enter the logical interface address.                            |
| Secondary IP address | Specifies the source address for monitoring packets on a secondary link.  | Enter the secondary IP address.                                 |
| Add                  | Adds the IPv4 address to be monitored.                                    | Click <b>Add</b> .                                              |
| Delete               | Deletes the IPv4 address to be monitored.                                 | Select the IPv4 address from the list and click <b>Delete</b> . |

**SEE ALSO**

[Chassis Cluster Feature Guide for Security Devices](#)

## Deploy vSRX Virtual Firewall Chassis Cluster Nodes Across Different ESXi Hosts Using dvSwitch

Before you deploy the vSRX Virtual Firewall chassis cluster nodes for ESXi 6.0 (or greater) hosts using distributed virtual switch (dvSwitch), ensure that you make the following configuration settings from the vSphere Web Client to ensure that the high-availability cluster control link works properly between the two nodes:

- In the dvSwitch switch settings of the vSphere Web Client, disable IGMP snooping for Multicast filtering mode (see [Multicast Snooping on a vSphere Distributed Switch](#)).
- In the dvSwitch port group configuration of the vSphere Web Client, enable promiscuous mode (see [Configure the Security Policy for a Distributed Port Group or Distributed Port](#)).

This chassis cluster method uses the private virtual LAN (PVLAN) feature of dvSwitch to deploy the vSRX Virtual Firewall chassis cluster nodes at different ESXi hosts. There is no need to change the external switch configurations.

On the VMware vSphere Web Client, for dvSwitch, there are two PVLAN IDs for the primary and secondary VLANs. Select **Community** in the menu for the secondary VLAN ID type.

Use the two secondary PVLAN IDs for the vSRX Virtual Firewall control and fabric links. See [Figure 28 on page 175](#) and [Figure 29 on page 176](#).

**Figure 28: dvPortGroup3 Settings**

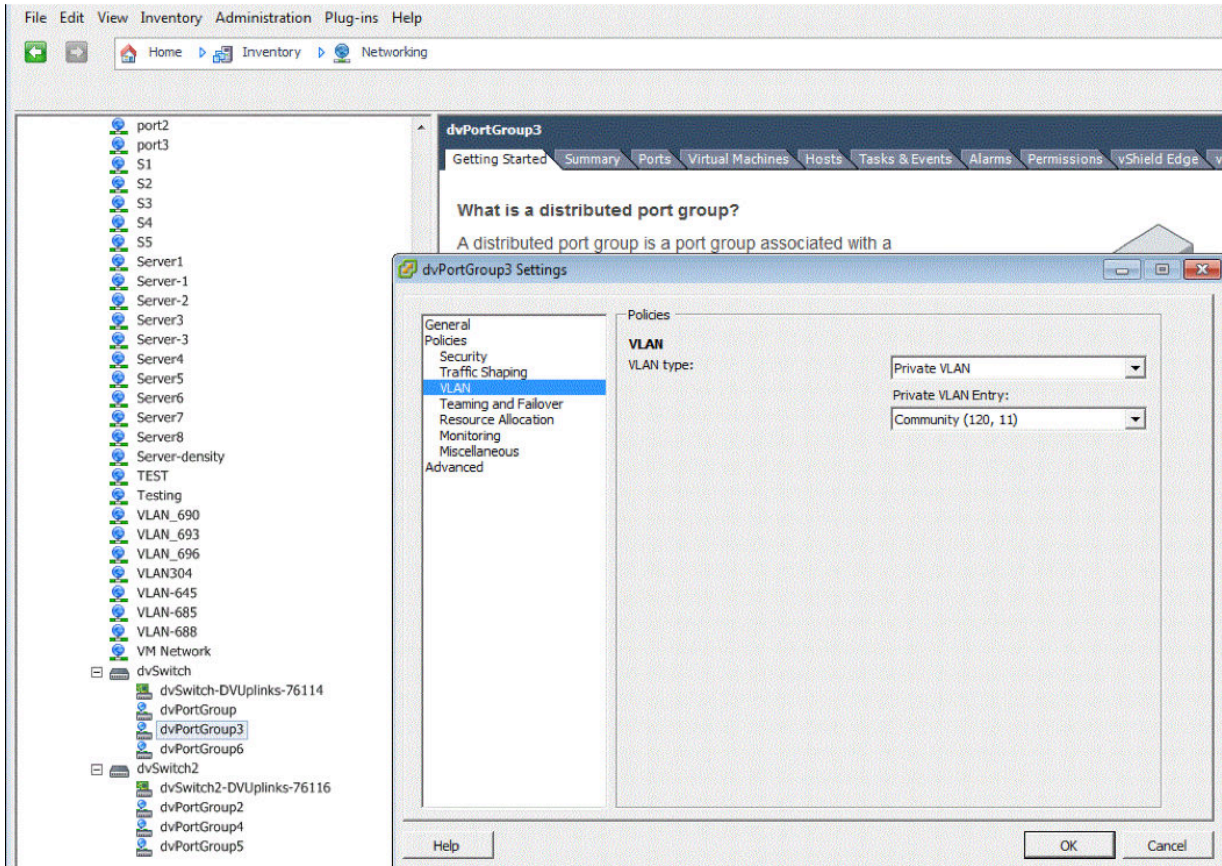
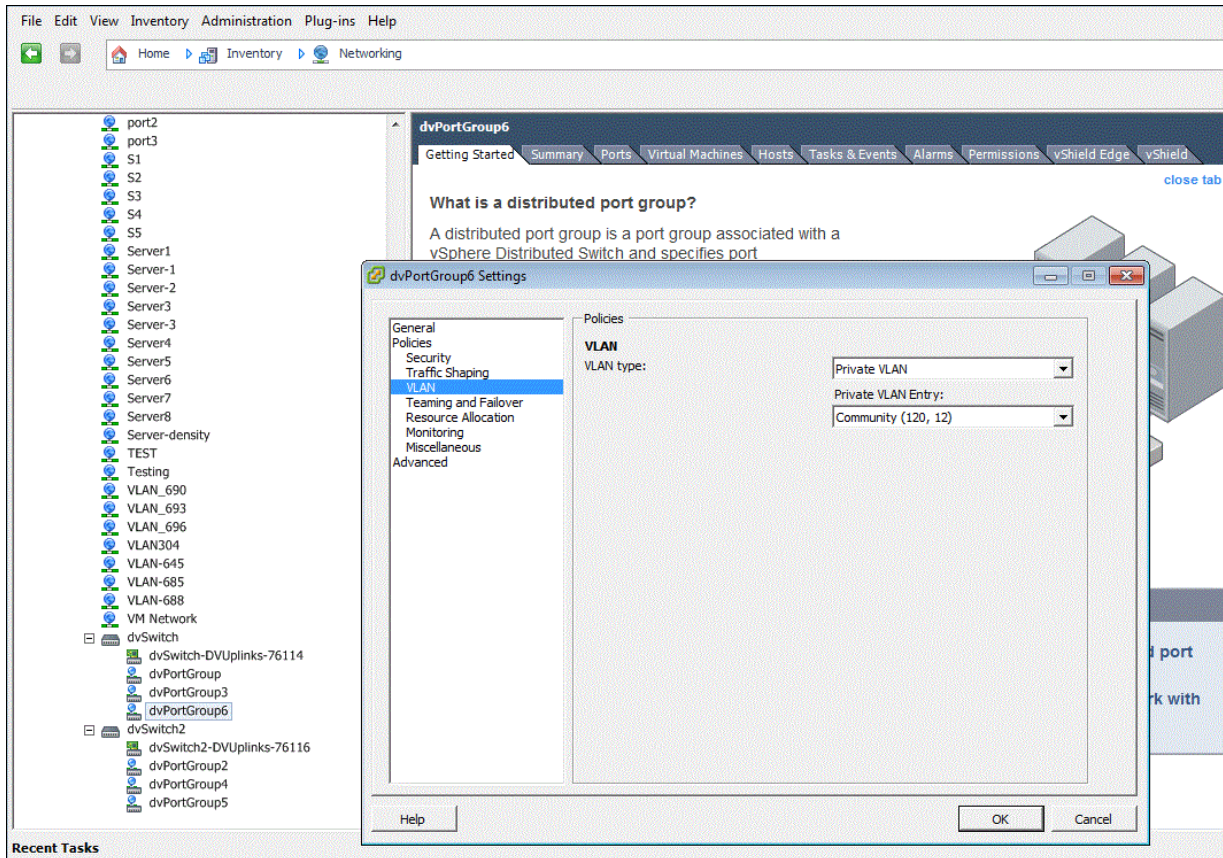




Figure 29: dvPortGroup6 Settings



**NOTE:** The configurations described above must reside at an external switch to which distributed switch uplinks are connected. If the link at the external switch supports native VLAN, then VLAN can be set to none in the distributed switch port group configuration. If native VLAN is not supported on the link, this configuration should have VLAN enabled.

You can also use regular VLAN on a distributed switch to deploy vSRX Virtual Firewall chassis cluster nodes at different ESXi hosts using dvSwitch. Regular VLAN works similarly to a physical switch. If you want to use regular VLAN instead of PVLAN, disable IGMP snooping for chassis cluster links.

However, use of PVLAN is recommended because:

- PVLAN does not impose IGMP snooping.
- PVLAN can save VLAN IDs.

**NOTE:** When the vSRX Virtual Firewall cluster across multiple ESXi hosts communicates through physical switches, then you need to consider the other Layer 2 parameters at: [https://kb.juniper.net/library/CUSTOMERSERVICE/GLOBAL\\_JTAC/NT21/LAHAAppNotev4.pdf](https://kb.juniper.net/library/CUSTOMERSERVICE/GLOBAL_JTAC/NT21/LAHAAppNotev4.pdf).

# 3

PART

## vSRX Virtual Firewall Deployment for Microsoft Hyper-V

---

[Overview | 179](#)

[Install vSRX Virtual Firewall in Microsoft Hyper-V | 188](#)

[vSRX Virtual Firewall VM Management with Microsoft Hyper-V | 205](#)

[Configure vSRX Virtual Firewall Chassis Clusters | 222](#)

---

# Overview

## IN THIS CHAPTER

- [Understand vSRX Virtual Firewall with Microsoft Hyper-V | 179](#)
- [Requirements for vSRX Virtual Firewall on Microsoft Hyper-V | 181](#)

## Understand vSRX Virtual Firewall with Microsoft Hyper-V

### IN THIS SECTION

- [vSRX Virtual Firewall in Microsoft Hyper-V | 179](#)

This section presents an overview of vSRX Virtual Firewall as deployed in Microsoft Hyper-V.

### vSRX Virtual Firewall in Microsoft Hyper-V

Microsoft Hyper-V is a hypervisor-based virtualization technology. It provides software infrastructure and basic management tools that you can use to create and manage a virtualized server computing environment. This virtualized environment can be used to address a variety of business goals aimed at improving efficiency and reducing costs. Hyper-V works on x86- and x64-based systems running Windows.

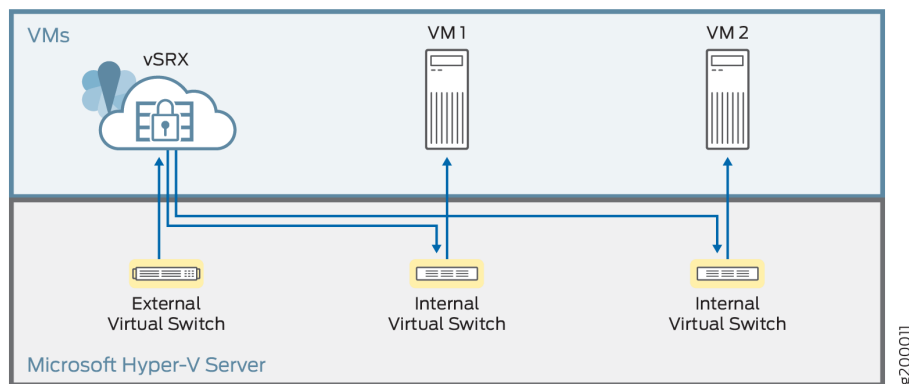
You deploy a vSRX Virtual Firewall virtual security appliance on a Microsoft Hyper-V server to provide networking security features for the virtualized server computing environment. Hyper-V implements isolation of virtual machines in terms of a partition. The vSRX Virtual Firewall virtual machine runs in Microsoft Hyper-V as a child partition. vSRX Virtual Firewall on Microsoft Hyper-V does not support the web-management http option for unencrypted HTTP connection settings.

Note the following for deploying vSRX Virtual Firewall on a Microsoft Hyper-V server:

- Starting in Junos OS Release 15.1X49-D80 and Junos OS Release 17.3R1, you can deploy the vSRX Virtual Firewall only on Microsoft Hyper-V Server 2012 R2 or 2012.
- Starting in Junos OS Release 15.1X49-D100 and Junos OS Release 17.4R1, you can deploy the vSRX Virtual Firewall on Microsoft Hyper-V Server 2016.

Figure 30 on page 180 illustrates the deployment of a vSRX Virtual Firewall in a Hyper-V environment to provide security for applications running on one or more virtual machines.

Figure 30: vSRX Virtual Firewall Deployment in Hyper-V



### Release History Table

| Release      | Description                                                                                                                                                      |
|--------------|------------------------------------------------------------------------------------------------------------------------------------------------------------------|
| 22.3R1       | Starting in Junos OS Release 22.3R1, you can deploy the vSRX Virtual Firewall 3.0 on Microsoft Hyper-V Windows Server 2019 and 2022 versions.                    |
| 15.1X49-D80  | Starting in Junos OS Release 15.1X49-D80 and Junos OS Release 17.3R1, you can deploy the vSRX Virtual Firewall only on Microsoft Hyper-V Server 2012 R2 or 2012. |
| 15.1X49-D100 | Starting in Junos OS Release 15.1X49-D100 and Junos OS Release 17.4R1, you can deploy the vSRX Virtual Firewall on Microsoft Hyper-V Server 2016.                |

### RELATED DOCUMENTATION

[Hyper-V on Windows Server 2016](#)

[Microsoft Hyper-V Overview](#)

## Requirements for vSRX Virtual Firewall on Microsoft Hyper-V

### IN THIS SECTION

- [Software Requirements | 181](#)
- [Hardware Requirements | 183](#)
- [Best Practices for Improving vSRX Virtual Firewall Performance | 183](#)
- [Interface Mapping for vSRX Virtual Firewall on Microsoft Hyper-V | 184](#)
- [vSRX Virtual Firewall Default Settings on Microsoft Hyper-V | 186](#)

This section presents an overview of requirements for deploying a vSRX Virtual Firewall instance on Microsoft Hyper-V.

### Software Requirements

[Table 35 on page 182](#) lists the software requirements for the vSRX Virtual Firewall instance on Microsoft Hyper-V.

**NOTE:** Only the vSRX Virtual Firewall small flavor is supported on Microsoft Hyper-V. vSRX Virtual Firewall 3.0 multi-CPU versions are supported on Microsoft Hyper-V.

**Table 35: Specifications for vSRX Virtual Firewall and vSRX Virtual Firewall 3.0 for Microsoft Hyper-V**

| Component                | Specification                                                                                                                                                                                                                                                                                                                                                                                                                                                                                                                                        |
|--------------------------|------------------------------------------------------------------------------------------------------------------------------------------------------------------------------------------------------------------------------------------------------------------------------------------------------------------------------------------------------------------------------------------------------------------------------------------------------------------------------------------------------------------------------------------------------|
| Hypervisor support       | <ul style="list-style-type: none"> <li>Starting in Junos OS Release 15.1X49-D80 and Junos OS Release 17.3R1, you can deploy the vSRX Virtual Firewall only on Microsoft Hyper-V Windows Server 2012 R2 or 2012.</li> <li>Starting in Junos OS Release 15.1X49-D100 and Junos OS Release 17.4R1, you can deploy the vSRX Virtual Firewall on Microsoft Hyper-V Windows Server 2016.</li> <li>Starting in Junos OS Release 22.3R1, you can deploy the vSRX Virtual Firewall 3.0 on Microsoft Hyper-V Windows Server 2019 and 2022 versions.</li> </ul> |
| Memory                   | 4 GB                                                                                                                                                                                                                                                                                                                                                                                                                                                                                                                                                 |
| Disk space               | 16 GB (IDE or SCSI drives)                                                                                                                                                                                                                                                                                                                                                                                                                                                                                                                           |
| vCPUs                    | 2                                                                                                                                                                                                                                                                                                                                                                                                                                                                                                                                                    |
| Virtual network adapters | 8 Hyper-V specific network adapters                                                                                                                                                                                                                                                                                                                                                                                                                                                                                                                  |

**Table 36: Specifications for vSRX Virtual Firewall 3.0 for Microsoft Hyper-V**

| Component          | Specification                                                                                                                          |
|--------------------|----------------------------------------------------------------------------------------------------------------------------------------|
| Hypervisor support | <ul style="list-style-type: none"> <li>Microsoft Hyper-V Windows Server 2016</li> <li>Microsoft Hyper-V Windows Server 2019</li> </ul> |
| Memory             | 4 GB                                                                                                                                   |
| Disk space         | 18 GB (IDE)                                                                                                                            |
| vCPUs              | 2                                                                                                                                      |

**Table 36: Specifications for vSRX Virtual Firewall 3.0 for Microsoft Hyper-V (Continued)**

| Component                | Specification                       |
|--------------------------|-------------------------------------|
| Virtual network adapters | 8 Hyper-V specific network adapters |

Starting in Junos OS Release 19.1R1, the vSRX Virtual Firewall 3.0 instance supports guest OS with 2 vCPUs, 4-GB virtual RAM, and a 18-GB disk space on Microsoft Hyper-V and Azure for improved performance.

## Hardware Requirements

[Table 37 on page 183](#) lists the hardware specifications for the host machine that runs the vSRX Virtual Firewall VM.

**Table 37: Hardware Specifications for the Host Machine**

| Component                                   | Specification                                                                                                                                                                         |
|---------------------------------------------|---------------------------------------------------------------------------------------------------------------------------------------------------------------------------------------|
| Host memory size                            | Minimum 4 GB                                                                                                                                                                          |
| Host processor type                         | x86 or x64-based multicore processor<br><br><b>NOTE:</b> DPDK requires Intel Virtualization VT-x/VT-d support in the CPU. See <a href="#">About Intel Virtualization Technology</a> . |
| Gigabit (10/100/1000baseT) Ethernet adapter | Emulates the multiport DEC 21140 10/100TX 100 MB Ethernet network adapter with one to four network connections.                                                                       |

## Best Practices for Improving vSRX Virtual Firewall Performance

Review the following practices to improve vSRX Virtual Firewall performance.

### NUMA Nodes

The x86 server architecture consists of multiple sockets and multiple cores within a socket. Each socket also has memory that is used to store packets during I/O transfers from the NIC to the host. To efficiently read packets from memory, guest applications and associated peripherals (such as the NIC)



should reside within a single socket. A penalty is associated with spanning CPU sockets for memory accesses, which might result in nondeterministic performance. For vSRX Virtual Firewall, we recommend that all vCPUs for the vSRX Virtual Firewall VM are in the same physical non-uniform memory access (NUMA) node for optimal performance.



**CAUTION:** The Packet Forwarding Engine (PFE) on the vSRX Virtual Firewall will become unresponsive if the NUMA nodes topology is configured in the hypervisor to spread the instance's vCPUs across multiple host NUMA nodes. vSRX Virtual Firewall requires that you ensure that all vCPUs reside on the same NUMA node.

We recommend that you bind the vSRX Virtual Firewall instance with a specific NUMA node by setting NUMA node affinity. NUMA node affinity constrains the vSRX Virtual Firewall VM resource scheduling to only the specified NUMA node.

## Interface Mapping for vSRX Virtual Firewall on Microsoft Hyper-V

Each network adapter defined for a vSRX Virtual Firewall is mapped to a specific interface, depending on whether the vSRX Virtual Firewall instance is a standalone VM or one of a cluster pair for high availability.

**NOTE:** Starting in Junos OS Release 15.1X49-D100 for vSRX Virtual Firewall, support for chassis clustering to provide network node redundancy is only available on Microsoft Hyper-V Server 2016 and higher.

Note the following:

- In standalone mode:
  - fxp0 is the out-of-band management interface.
  - ge-0/0/0 is the first traffic (revenue) interface.
- In cluster mode:
  - fxp0 is the out-of-band management interface.
  - em0 is the cluster control link for both nodes.
  - Any of the traffic interfaces can be specified as the fabric links, such as ge-0/0/0 for fab0 on node 0 and ge-7/0/0 for fab1 on node 1.

[Table 38 on page 185](#) shows the interface names and mappings for a standalone vSRX Virtual Firewall VM.

**Table 38: Interface Names for a Standalone vSRX Virtual Firewall VM**

| Network Adapter | Interface Name in Junos OS |
|-----------------|----------------------------|
| 1               | fxp0                       |
| 2               | ge-0/0/0                   |
| 3               | ge-0/0/1                   |
| 4               | ge-0/0/2                   |
| 5               | ge-0/0/3                   |
| 6               | ge-0/0/4                   |
| 7               | ge-0/0/5                   |
| 8               | ge-0/0/6                   |

[Table 39 on page 185](#) shows the interface names and mappings for a pair of vSRX Virtual Firewall VMs in a cluster (node 0 and node 1).

**Table 39: Interface Names for a vSRX Virtual Firewall Cluster Pair**

| Network Adapter | Interface Name in Junos OS             |
|-----------------|----------------------------------------|
| 1               | fxp0 (node 0 and 1)                    |
| 2               | em0 (node 0 and 1)                     |
| 3               | ge-0/0/0 (node 0)<br>ge-7/0/0 (node 1) |

**Table 39: Interface Names for a vSRX Virtual Firewall Cluster Pair (Continued)**

| Network Adapter | Interface Name in Junos OS             |
|-----------------|----------------------------------------|
| 4               | ge-0/0/1 (node 0)<br>ge-7/0/1 (node 1) |
| 5               | ge-0/0/2 (node 0)<br>ge-7/0/2 (node 1) |
| 6               | ge-0/0/3 (node 0)<br>ge-7/0/3 (node 1) |
| 7               | ge-0/0/4 (node 0)<br>ge-7/0/4 (node 1) |
| 8               | ge-0/0/5 (node 0)<br>ge-7/0/5 (node 1) |

### vSRX Virtual Firewall Default Settings on Microsoft Hyper-V

vSRX Virtual Firewall requires the following basic configuration settings:

- Interfaces must be assigned IP addresses.
- Interfaces must be bound to zones.
- Policies must be configured between zones to permit or deny traffic.

[Table 40 on page 186](#) lists the factory-default settings for security policies on the vSRX Virtual Firewall.

**Table 40: Factory Default Settings for Security Policies**

| Source Zone | Destination Zone | Policy Action |
|-------------|------------------|---------------|
| trust       | untrust          | permit        |
| trust       | trust            | permit        |

**Table 40: Factory Default Settings for Security Policies (Continued)**

| Source Zone | Destination Zone | Policy Action |
|-------------|------------------|---------------|
| untrust     | trust            | deny          |

**Release History Table**

| Release      | Description                                                                                                                                                                                                   |
|--------------|---------------------------------------------------------------------------------------------------------------------------------------------------------------------------------------------------------------|
| 19.1R1       | Starting in Junos OS Release 19.1R1, the vSRX Virtual Firewall 3.0 instance supports guest OS with 2 vCPUs, 4-GB virtual RAM, and a 18-GB disk space on Microsoft Hyper-V and Azure for improved performance. |
| 15.1X49-D80  | Starting in Junos OS Release 15.1X49-D80 and Junos OS Release 17.3R1, you can deploy the vSRX Virtual Firewall only on Microsoft Hyper-V Server 2012 R2 or 2012.                                              |
| 15.1X49-D100 | Starting in Junos OS Release 15.1X49-D100 and Junos OS Release 17.4R1, you can deploy the vSRX Virtual Firewall on Microsoft Hyper-V Server 2016.                                                             |
| 15.1X49-D100 | Starting in Junos OS Release 15.1X49-D100 for vSRX Virtual Firewall, support for chassis clustering to provide network node redundancy is only available on Microsoft Hyper-V Server 2016 and higher.         |

**RELATED DOCUMENTATION**

[KB Article - Interface must be in the same routing instance as the other interfaces in the zone](#)

[About Intel Virtualization Technology](#)

[DPDK Release Notes](#)

# Install vSRX Virtual Firewall in Microsoft Hyper-V

## IN THIS CHAPTER

- Prepare for vSRX Virtual Firewall Deployment in Microsoft Hyper-V | 188
- Deploy vSRX Virtual Firewall in a Hyper-V Host Using the Hyper-V Manager | 189
- Deploy vSRX Virtual Firewall in a Hyper-V Host Using Windows PowerShell | 200

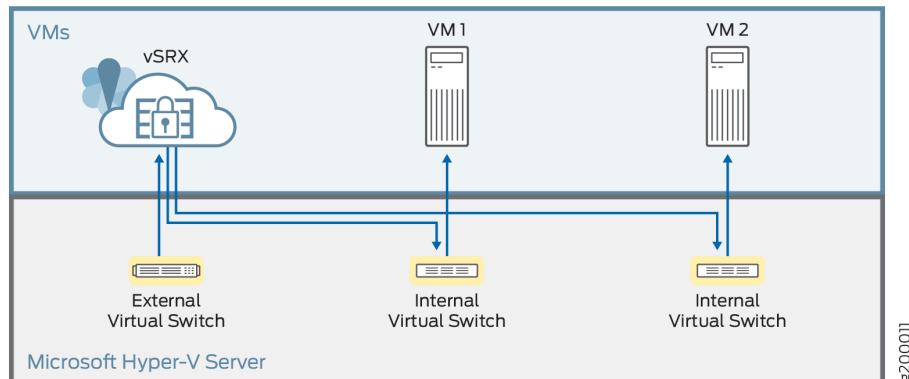
## Prepare for vSRX Virtual Firewall Deployment in Microsoft Hyper-V

Note the following guidelines when deploying vSRX Virtual Firewall on a Microsoft Hyper-V server:

- Starting in Junos OS Release 15.1X49-D80 and Junos OS Release 17.3R1, you can deploy the vSRX Virtual Firewall only on Microsoft Hyper-V Server 2012 R2 or 2012.
- Starting in Junos OS Release 15.1X49-D100 and Junos OS Release 17.4R1, you can deploy the vSRX Virtual Firewall on Microsoft Hyper-V Server 2016.
- Starting in Junos OS Release 22.3R1, you can deploy the vSRX Virtual Firewall 3.0 on Microsoft Hyper-V Windows Server 2019 and 2022 versions.
- Ensure that the host CPU supports a 64-bit x86 Intel processor and is running Windows.
- Ensure that you have a user account with administrator permissions to enable the computer to deploy a vSRX Virtual Firewall virtual machine (VM) using either Microsoft Hyper-V Manager or Windows PowerShell.
- Create the virtual switches on the Hyper-V host computer necessary to support the fxp0 (out-of-band management) interface and the traffic (revenue) interface supported by the vSRX Virtual Firewall VM. You create virtual switches using either the Microsoft Hyper-V Manager or Windows PowerShell. See *Add vSRX Interfaces* for details on adding virtual switches for the vSRX Virtual Firewall VM using the Virtual Switch Manager.

[Figure 31 on page 189](#) illustrates the deployment of a vSRX Virtual Firewall in a Hyper-V environment to provide security for applications running on one or more virtual machines.

Figure 31: Example of vSRX Virtual Firewall Deployment in Hyper-V



### Release History Table

| Release      | Description                                                                                                                                                      |
|--------------|------------------------------------------------------------------------------------------------------------------------------------------------------------------|
| 15.1X49-D80  | Starting in Junos OS Release 15.1X49-D80 and Junos OS Release 17.3R1, you can deploy the vSRX Virtual Firewall only on Microsoft Hyper-V Server 2012 R2 or 2012. |
| 15.1X49-D100 | Starting in Junos OS Release 15.1X49-D100 and Junos OS Release 17.4R1, you can deploy the vSRX Virtual Firewall on Microsoft Hyper-V Server 2016.                |

### RELATED DOCUMENTATION

[Install Hyper-V and Create a Virtual Machine](#)

[Create a Virtual Machine in Hyper-V](#)

[Create a Virtual Switch for Hyper-V Virtual Machines](#)

[Hyper-V Virtual Switch](#)

## Deploy vSRX Virtual Firewall in a Hyper-V Host Using the Hyper-V Manager

Use this procedure to deploy and configure the vSRX Virtual Firewall as a virtual security appliance in the Hyper-V environment using Hyper-V Manager.

Note the following for deploying vSRX Virtual Firewall on a Microsoft Hyper-V server:

- Starting in Junos OS Release 15.1X49-D80 and Junos OS Release 17.3R1, you can deploy the vSRX Virtual Firewall only on Microsoft Hyper-V Server 2012 R2 or 2012.
- Starting in Junos OS Release 15.1X49-D100 and Junos OS Release 17.4R1, you can deploy the vSRX Virtual Firewall on Microsoft Hyper-V Server 2016.

**NOTE:** To upgrade an existing vSRX Virtual Firewall instance, see *Migration, Upgrade, and Downgrade* in the *vSRX Virtual Firewall Release Notes*.

To deploy vSRX Virtual Firewall using Hyper-V Manager:

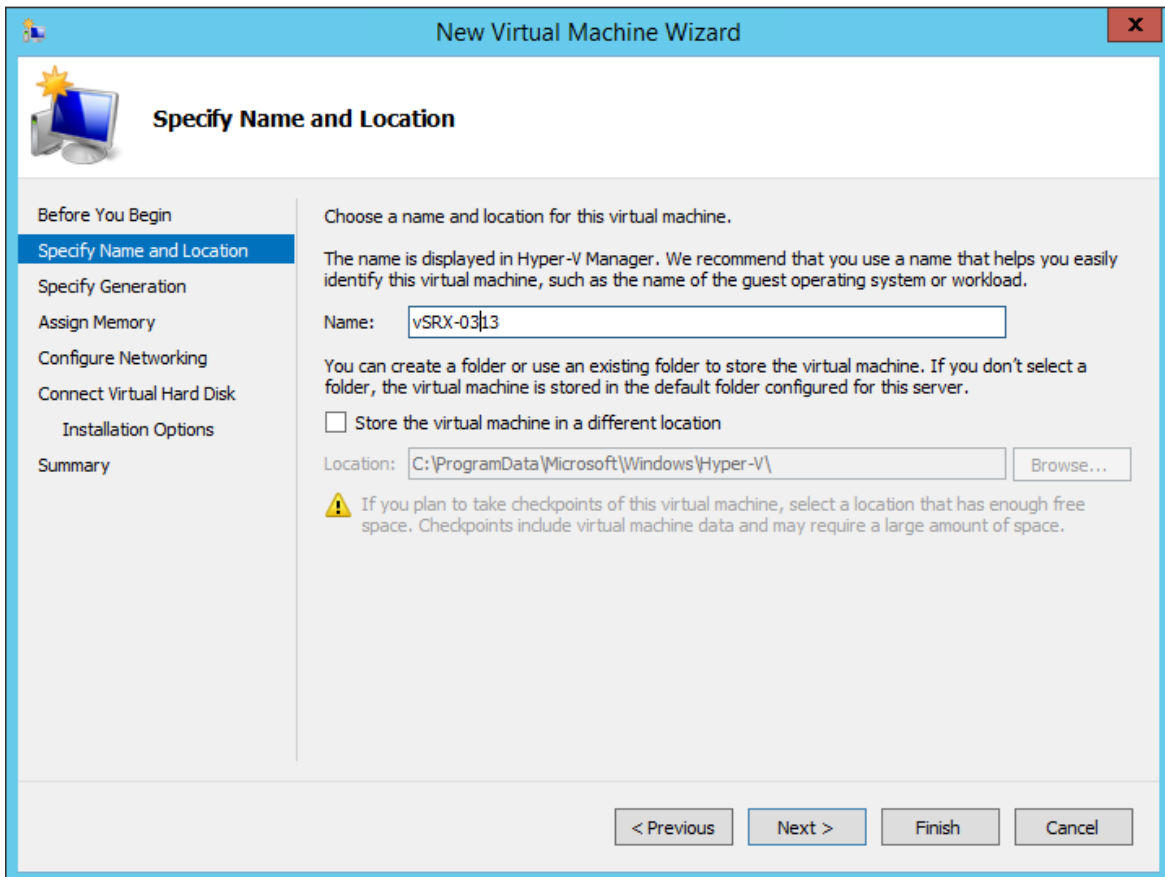
1. Download the vSRX Virtual Firewall software image for Microsoft Hyper-V from the [Juniper Networks website](#). The vSRX Virtual Firewall disk image supported by Microsoft Hyper-V is a virtual hard disk (VHD) format file.



**CAUTION:** Do not change the filename of the downloaded software image or the installation will fail.

2. Log onto your Hyper-V host computer using the Administrator account.
3. Open the Hyper-V Manager by selecting **Start > Administrative Tools > Hyper-V Manager**. The welcome page for Hyper-V appears the first time that you open Hyper-V Manager.
4. Create a virtual machine by selecting **Action > New > Virtual Machine**. The Before You Begin screen appears for the New Virtual Machine Wizard. Click **Next** to move through each page of the wizard, or you can click the name of a page in the left pane to move directly to that page.
5. From the Specify Name and Location page (see [Figure 32 on page 191](#)), enter a name and location for the vSRX Virtual Firewall VM that you are creating and then click **Next**. We recommend that you keep this name the same as the hostname you intend to assign to the vSRX Virtual Firewall VM.

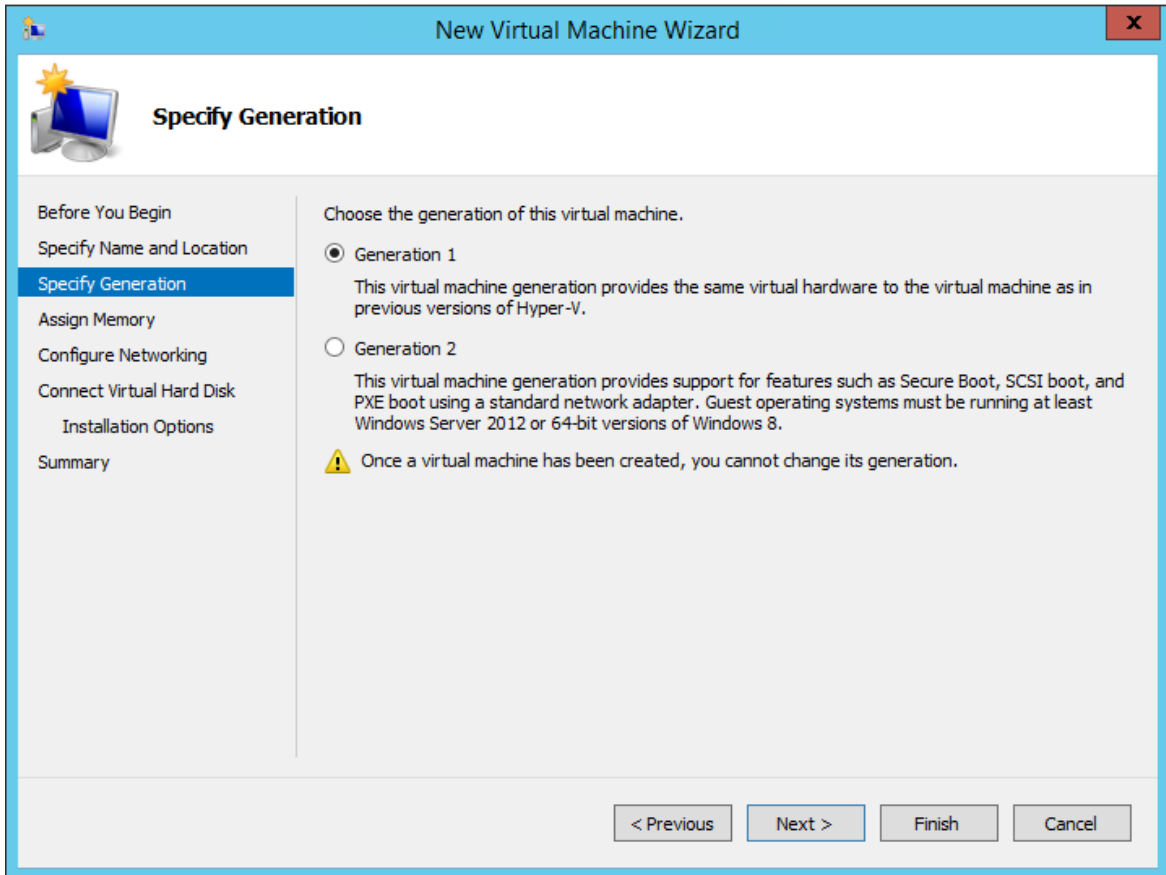
Figure 32: Specify Name and Location Page



6. From the Specify Generation page (see [Figure 33 on page 192](#)), keep the default setting of **Generation 1** as the generation of the vSRX Virtual Firewall VM and then click **Next**.

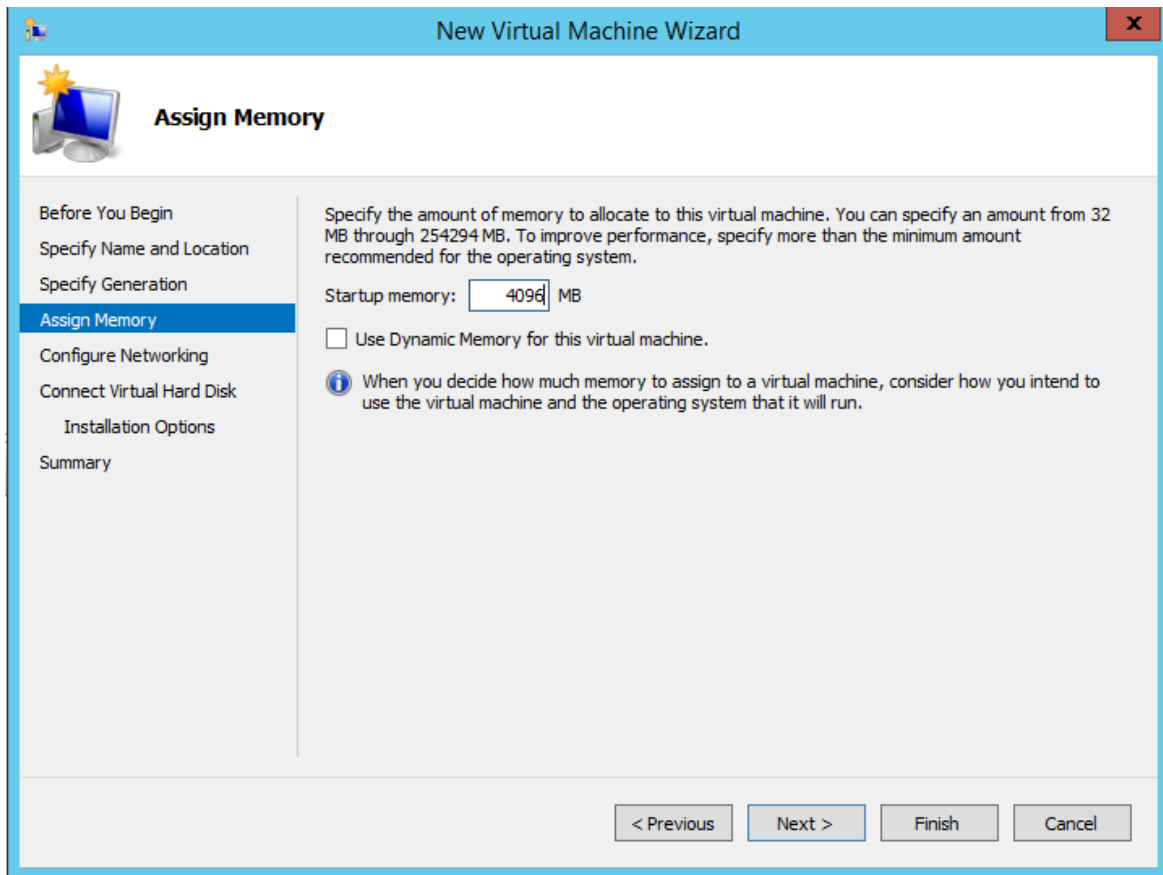


Figure 33: Specify Generation Page



7. From the Assign Memory page (see [Figure 34 on page 193](#)), enter **4096 MB** as the amount of startup memory to assign to the vSRX Virtual Firewall VM. Leave **Use Dynamic Memory for this virtual machine** clear. Click **Next**.

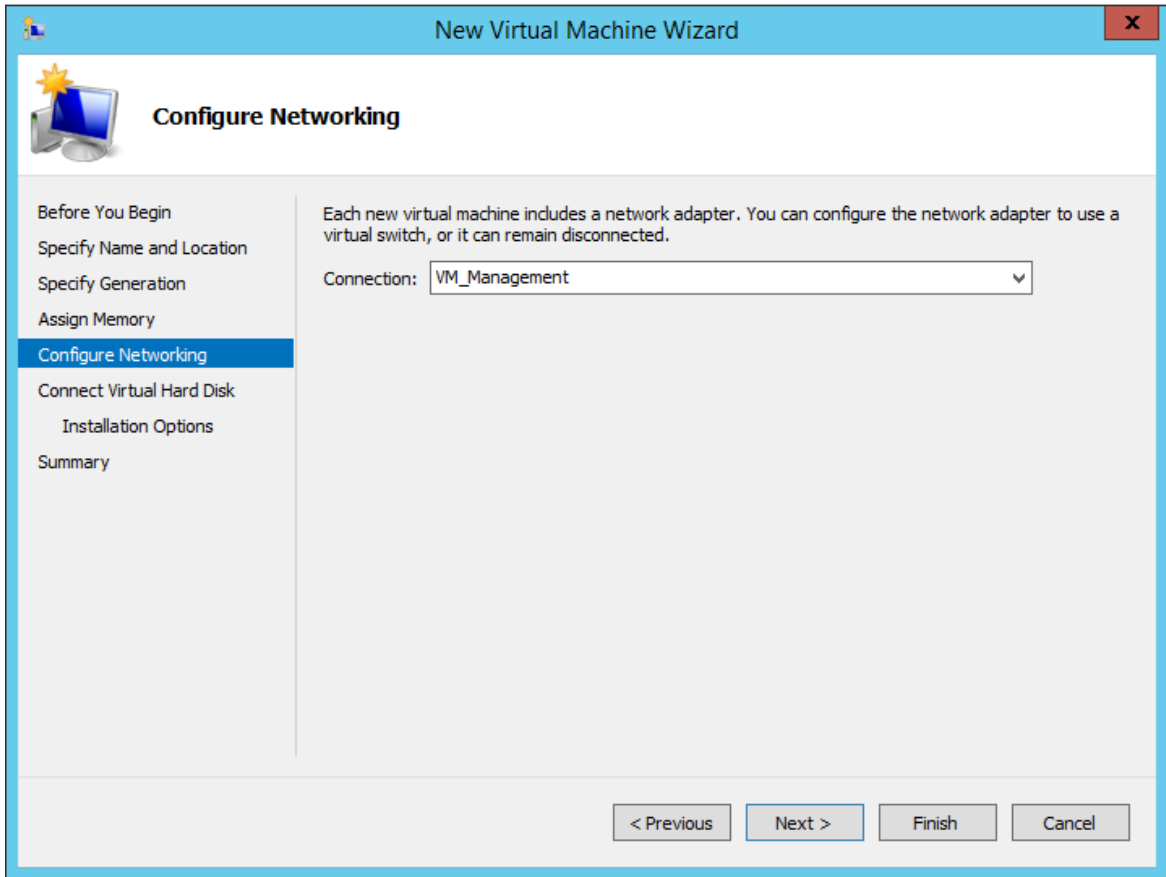
Figure 34: Assign Memory Page



- From the Configure Networking page (see [Figure 35 on page 194](#)), select a virtual switch from a list of existing virtual switches on the Hyper-V host computer to connect to the vSRX Virtual Firewall management interface. The default is **Not connected**. Click **Next**.

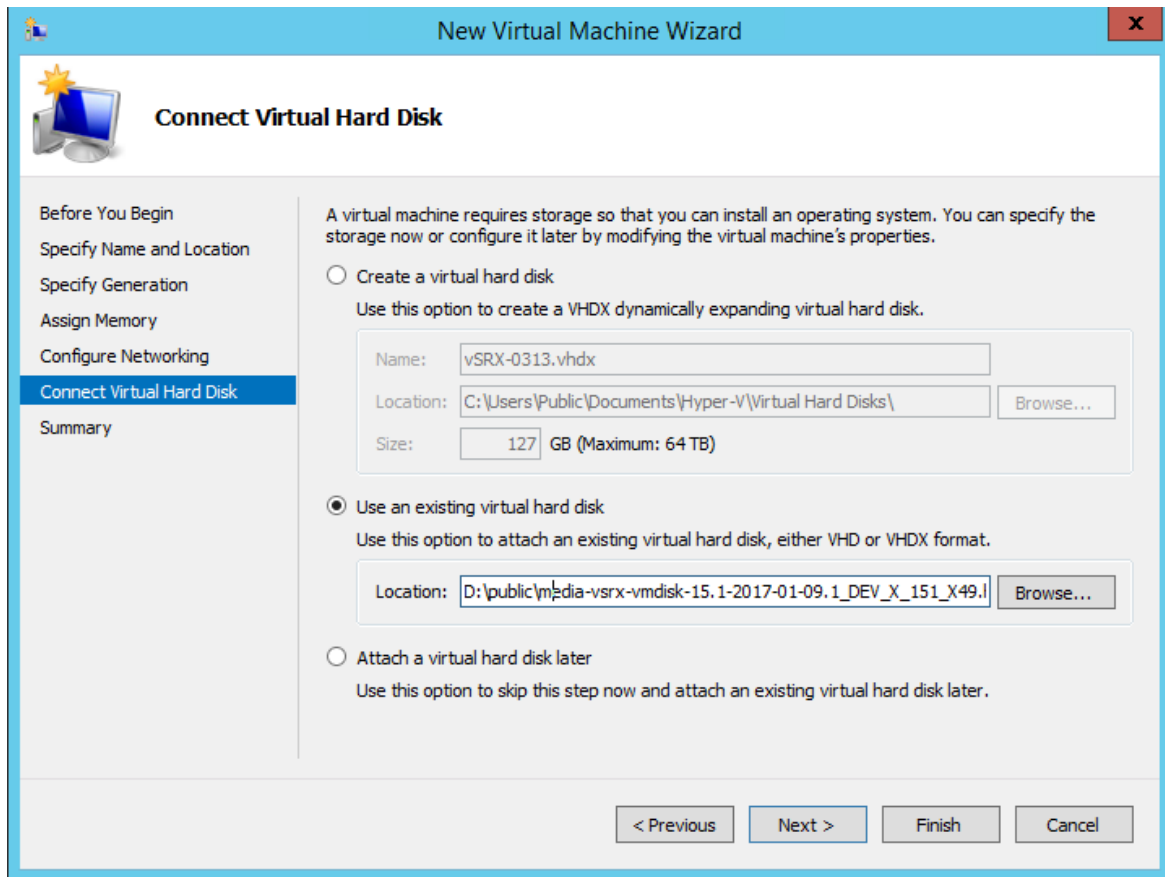
**NOTE:** See *Add vSRX Interfaces* for the procedure on adding virtual switches for the vSRX Virtual Firewall VM using the Virtual Switch Manager.

Figure 35: Configure Networking Page



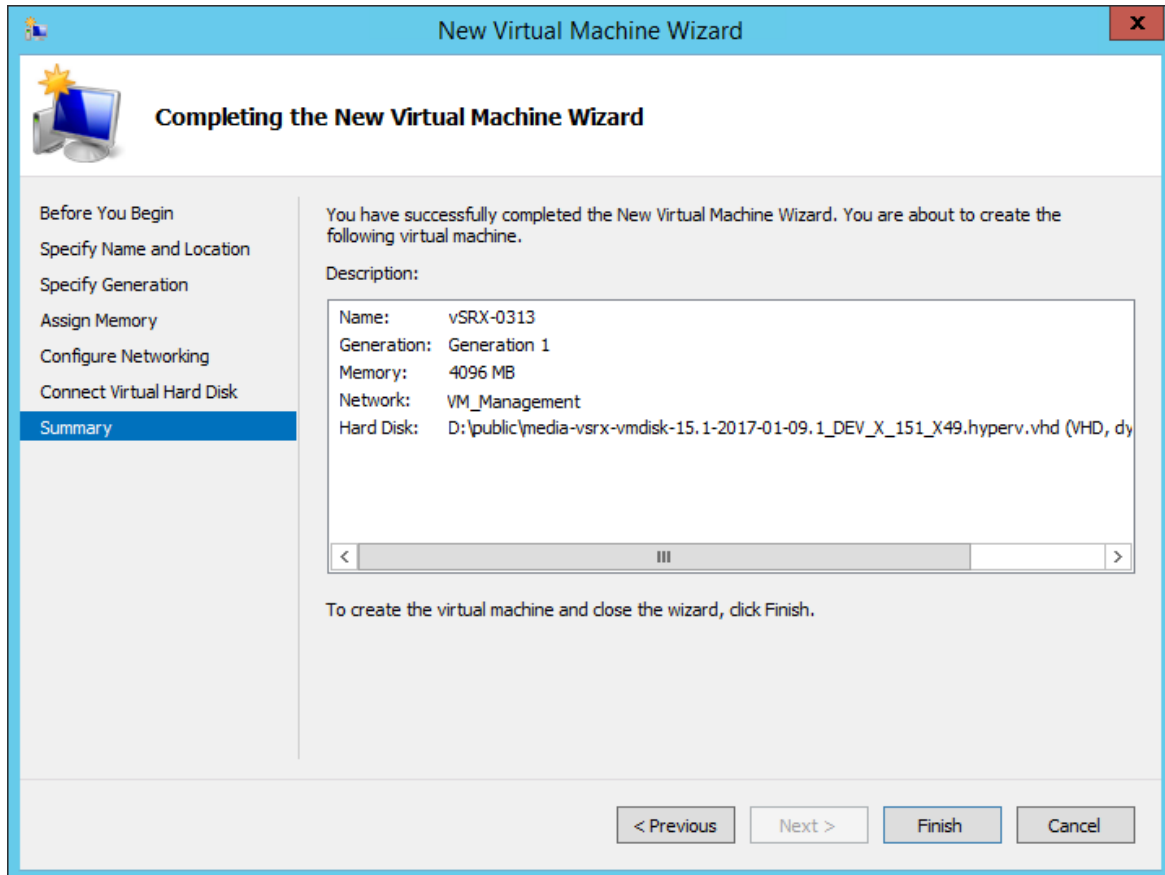
9. From the Connect Virtual Hard Disk page (see [Figure 36 on page 195](#)), click **Use an existing virtual hard disk** and browse to the location of the vSRX Virtual Firewall virtual hard disk (VHD) file (downloaded in Step 1). Click **Next**.

Figure 36: Connect Virtual Hard Disk Page



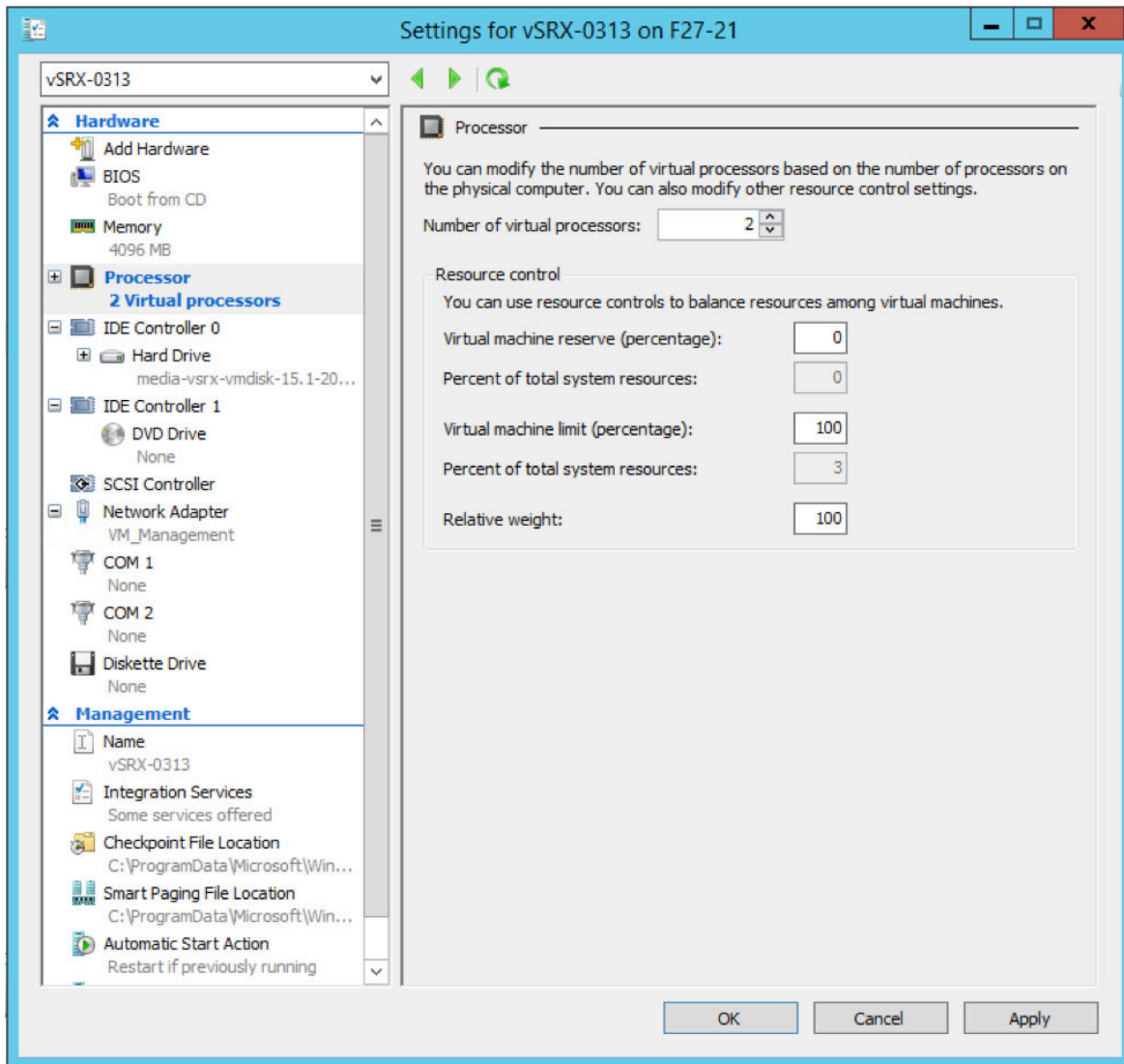
10. After you have finished configuring the new virtual machine, verify your selections in the Summary page (see [Figure 37 on page 196](#)) and then click **Finish** to complete the installation.

Figure 37: Summary Page



11. Right-click the vSRX Virtual Firewall VM and select **Settings** from the context menu.
12. From the Settings dialog box, under the Hardware section, select **Processor**. The Processor pane appears (see [Figure 38 on page 197](#)). Enter **2** in the **Number of virtual processors** field (the default is 1).

Figure 38: Processor Pane

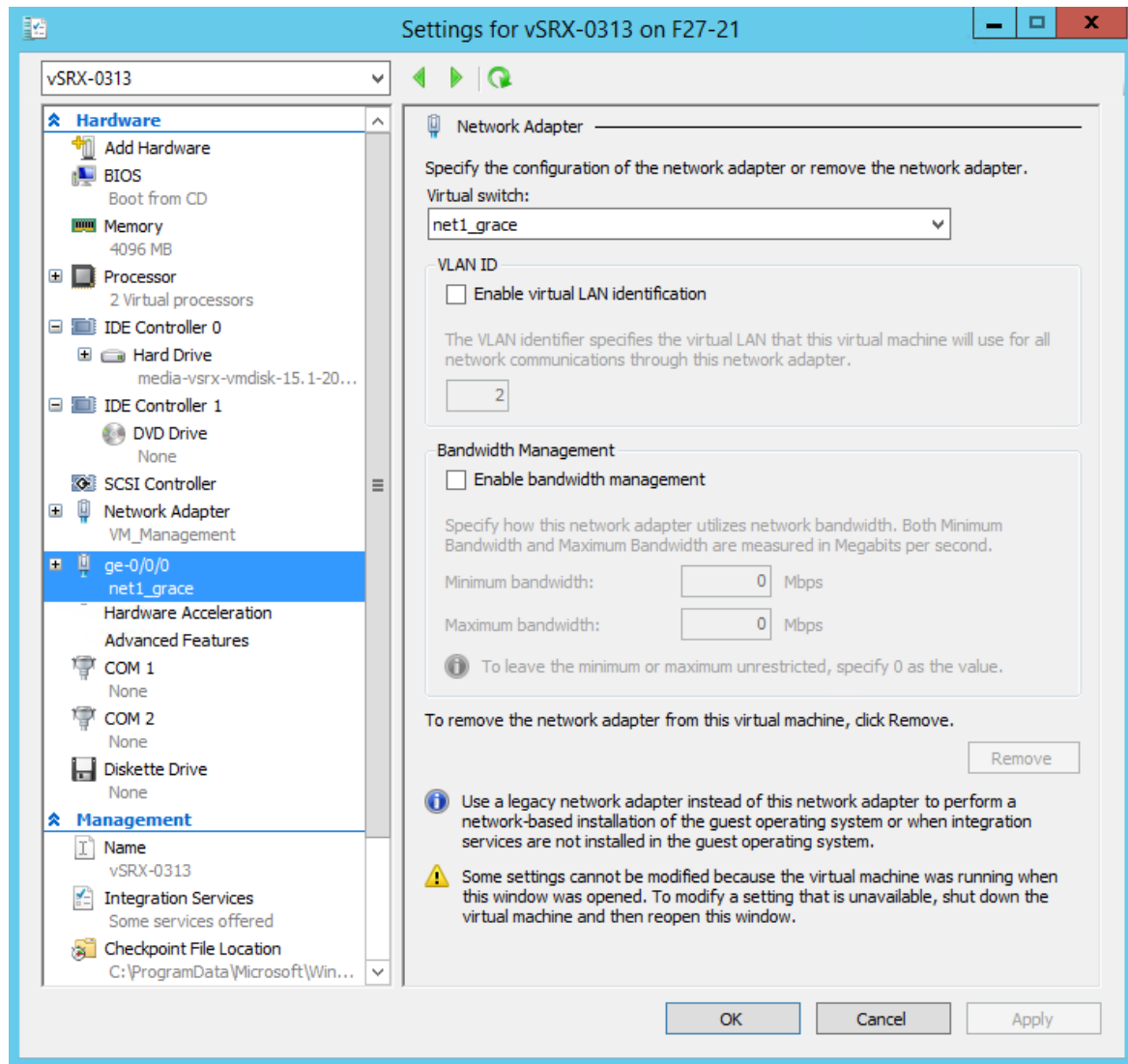


13. From the Settings dialog box, under the Hardware section, select **Network Adapter**. The Network Adapter pane appears (see [Figure 39](#) on page 198).

From the Virtual switch drop-down list, select a virtual switch to assign to a network adapter to be used by the vSRX Virtual Firewall VM (see *Add vSRX Interfaces* for details on adding virtual switches). Each network adapter that is defined for a vSRX Virtual Firewall is mapped to a specific interface. See *Requirements for vSRX on Microsoft Hyper-V* for a summary of interface names and mappings for a vSRX Virtual Firewall VM.

**NOTE:** If you need to add a network adapter to assign to a virtual switch, click **Add Hardware > Network Adapter > Add**.

Figure 39: Network Adapter Pane

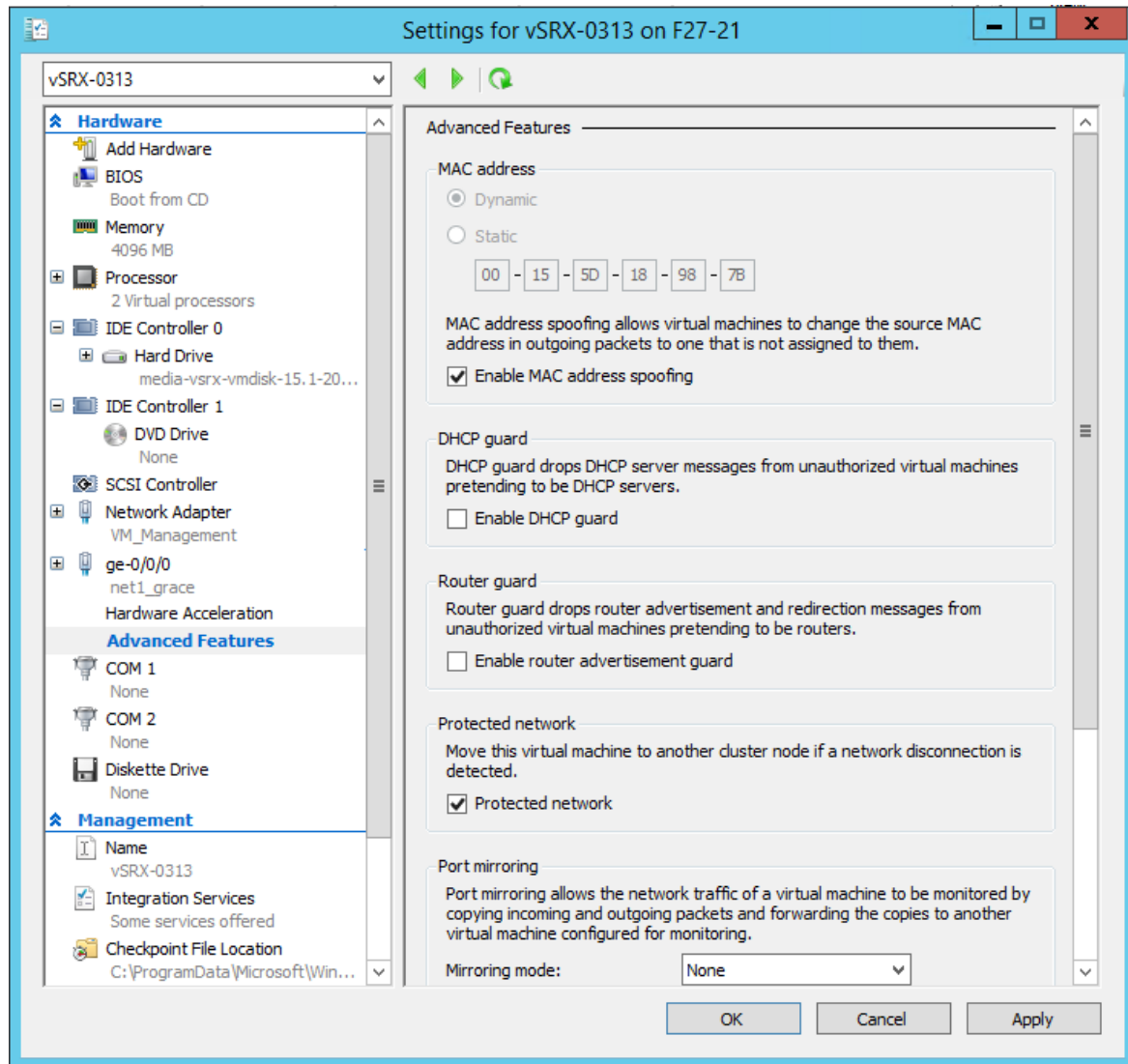


14. Enable the MAC address spoofing function for the vSRX Virtual Firewall VM if a network adapter is to be used as an interface for Layer 2 mode support on the vSRX Virtual Firewall. From the Network Adapter pane select **Advanced Features**. The Advanced Features pane appears (see [Figure 40 on page 199](#)). Click the **Enable MAC address spoofing** check box.

MAC address spoofing allows each network adapter to change its source MAC address for outgoing packets to one that is not assigned to them. Enabling MAC address spoofing ensures those packets are not dropped by the network adapter if the source MAC address fails to match the outgoing interface MAC address.

Click **OK** when you complete your vSRX Virtual Firewall VM selections.

Figure 40: Network Adapter Advanced Features Pane



- On Microsoft Hyper-V Server 2016, you will need to enable nested virtualization for the vSRX Virtual Firewall VM before you power on the vSRX Virtual Firewall instance. This procedure can only be performed in the Hyper-V environment using Windows PowerShell (see, *Deploy vSRX in a Hyper-V Host Using Windows PowerShell*, Step 9). You cannot enable nested virtualization from the Hyper-V Manager because nested virtualization is not supported on Microsoft Hyper-V Server 2012.

**NOTE:** This step is applicable only for vSRX Virtual Firewall (which uses and requires nested virtualization) and not for vSRX Virtual Firewall 3.0.



**NOTE:** Nested virtualization can only be configured on a host running Microsoft Hyper-V Server 2016. In addition, Dynamic Memory must be disabled on the virtual machine containing the nested instance of Hyper-V.

16. Launch and power on the vSRX Virtual Firewall instance in the Hyper-V Manager by selecting the vSRX Virtual Firewall VM from the list of virtual machines. Right-click and select **Start** from the context menu (or select **Action > Start**).
17. Configure the basic settings for the vSRX Virtual Firewall (see *Configure vSRX Using the CLI*).

#### Release History Table

| Release      | Description                                                                                                                                                      |
|--------------|------------------------------------------------------------------------------------------------------------------------------------------------------------------|
| 15.1X49-D80  | Starting in Junos OS Release 15.1X49-D80 and Junos OS Release 17.3R1, you can deploy the vSRX Virtual Firewall only on Microsoft Hyper-V Server 2012 R2 or 2012. |
| 15.1X49-D100 | Starting in Junos OS Release 15.1X49-D100 and Junos OS Release 17.4R1, you can deploy the vSRX Virtual Firewall on Microsoft Hyper-V Server 2016.                |

#### RELATED DOCUMENTATION

- [Install Hyper-V and Create a Virtual Machine](#)
- [Create a Virtual Machine in Hyper-V](#)
- [Virtual Machine Settings in Hyper-V Manager Explained](#)

## Deploy vSRX Virtual Firewall in a Hyper-V Host Using Windows PowerShell

Use this procedure to deploy and configure the vSRX Virtual Firewall as a virtual security appliance in the Hyper-V environment using Windows PowerShell.

Note the following for deploying vSRX Virtual Firewall on a Microsoft Hyper-V server:

- Starting in Junos OS Release 15.1X49-D80 and Junos OS Release 17.3R1, you can deploy the vSRX Virtual Firewall only on Microsoft Hyper-V Server 2012 R2 or 2012.
- Starting in Junos OS Release 15.1X49-D100 and Junos OS Release 17.4R1, you can deploy the vSRX Virtual Firewall on Microsoft Hyper-V Server 2016.

**NOTE:** To upgrade an existing vSRX Virtual Firewall instance, see *Migration, Upgrade, and Downgrade* in the *vSRX Virtual Firewall Release Notes*.

To deploy vSRX Virtual Firewall using Windows PowerShell:

1. Download the vSRX Virtual Firewall software image for Microsoft Hyper-V from the [Juniper Networks website](#). The vSRX Virtual Firewall disk image supported by Microsoft Hyper-V is a virtual hard disk (VHD) format file.



**CAUTION:** Do not change the filename of the downloaded software image or the installation will fail.

2. On the Windows desktop, click the **Start** button and type **Windows PowerShell**.
3. Right-click **Windows PowerShell** and select **Run as administrator**.
4. Run the following command to enable Hyper-V using PowerShell:  
`Enable-WindowsOptionalFeature -Online -FeatureName Microsoft-Hyper-V -All`
5. Enter the `New-VM` command to create the vSRX Virtual Firewall VM. The command syntax is as follows:

```
PS C:>\Users\Administrator> New-VM -Name <Name> -MemoryStartupBytes <Memory> -BootDevice <BootDevice> -
VHDPATH <VHDPATH> -Path <Path> -Generation <Generation> -Switch <SwitchName>
```

See [Table 41 on page 201](#) for a summary of the parameters in the `New-VM` command.

**Table 41: New-VM Command Parameters**

| Parameter                        | Description                                                                                                                                                                        |
|----------------------------------|------------------------------------------------------------------------------------------------------------------------------------------------------------------------------------|
| <code>-Name</code>               | Specify a name for the vSRX Virtual Firewall VM that you are creating. We recommend keeping this name the same as the hostname you intend to give to the vSRX Virtual Firewall VM. |
| <code>-MemoryStartupBytes</code> | Enter 4GB as the amount of startup memory to assign to the vSRX Virtual Firewall VM.                                                                                               |
| <code>-BootDevice</code>         | Enter VHD as the device that the vSRX Virtual Firewall VM boots to when it starts.                                                                                                 |

**Table 41: New-VM Command Parameters (Continued)**

| Parameter          | Description                                                                                                                                                                                                                                                                                                                                                                                                                                                                                                                                                                                                                                                             |
|--------------------|-------------------------------------------------------------------------------------------------------------------------------------------------------------------------------------------------------------------------------------------------------------------------------------------------------------------------------------------------------------------------------------------------------------------------------------------------------------------------------------------------------------------------------------------------------------------------------------------------------------------------------------------------------------------------|
| <i>-VHDPath</i>    | Specify the location of the vSRX Virtual Firewall virtual hard disk (VHD) file that you want to deploy.                                                                                                                                                                                                                                                                                                                                                                                                                                                                                                                                                                 |
| <i>-Path</i>       | Specify the location to store the vSRX Virtual Firewall VM configuration files.                                                                                                                                                                                                                                                                                                                                                                                                                                                                                                                                                                                         |
| <i>-Generation</i> | Enter 1 to create a generation 1 virtual machine for the vSRX Virtual Firewall.                                                                                                                                                                                                                                                                                                                                                                                                                                                                                                                                                                                         |
| <i>-SwitchName</i> | Specify the name of the virtual switch that you want the vSRX Virtual Firewall VM to assign to a network adapter used by the vSRX Virtual Firewall VM. Each network adapter that is defined for a vSRX Virtual Firewall is mapped to a specific interface. See <i>Requirements for vSRX on Microsoft Hyper-V</i> for a summary of interface names and mappings for a vSRX Virtual Firewall VM.<br><br><b>NOTE:</b> To locate the name of a previously created virtual switch, use the <code>Get-VMswitch</code> command. See <i>Add vSRX Interfaces</i> for the procedure on adding virtual switches for the vSRX Virtual Firewall VM using the Virtual Switch Manager. |

The following is an example of the `New-VM` command syntax for creating a vSRX Virtual Firewall VM:

```
PS C:>\Users\Administrator> New-VM -Name vSRX_0109 -MemoryStartupBytes 4GB -BootDevice VHD -VHDPath C:\Users\Public\Documents\Hyper-V\vsrx-0109-powershell\vsrx\media-vsrx-vmdisk-151X49D80.hyper-v.vhd -Path 'C:\Users\Public\Documents\Hyper-V\vsrx-0109\' Generation 1 SwitchName test
```

- Set the number of processors for the newly created vSRX Virtual Firewall VM by entering the `Set-VMProcessor` command. Specify `Count 2` for the number of processors. For example:

```
PS C:>\Users\Administrator> Set-VMProcessor -VMName <vSRVName> -Count 2
```

- Verify the newly created vSRX Virtual Firewall VM by entering the `Get-VM` command. For example:

```
PS C:>\Users\Administrator> Get-VM -VMName <vSRVName>
```

The output for the command is as follows:

| Name      | State | CPUUsage(%) | MemoryAssigned(M) | Uptime   | State              | Version |
|-----------|-------|-------------|-------------------|----------|--------------------|---------|
| vSRX_0109 | Off   | 0           | 0                 | 00:00:00 | Operating normally | 8.0     |

8. Enable the MAC address spoofing function for the vSRX Virtual Firewall VM if a network adapter is to be used as an interface for Layer 2 mode support on the vSRX Virtual Firewall. MAC address spoofing allows the vSRX Virtual Firewall VM's network adapter to change its source MAC address for outgoing packets to one that is not assigned to them. Enabling MAC address spoofing ensures those packets are not dropped by the network adapter if the source MAC address fails to match the outgoing interface MAC address.

The command syntax is as follows:

```
PS C:\Users\Administrator> Set-VMNetworkAdapter -VMName <vSRVName> -computerName <HyperVHostName> -
VMNetworkAdapter <NetworkAdapterName> -MacAddressSpoofing On
```

Verify that MacAddressSpoofing is On.

```
PS C:\Users\Administrator> Get-VMNetworkAdapter -VMName <vSRVName> -computerName <HyperVHostName> | fl
<HyperVHostName>name,macaddressspoofing
```

The output for the command is as follows:

```
Name           : vSRX_0109
MacAddressSpoofing : On
```

9. Enable nested virtualization for the vSRX Virtual Firewall VM by using the Set-VMProcessor command, where VMName is the name of the vSRX Virtual Firewall VM you created. By default, the virtualization extensions are disabled for each VM. Nested virtualization allows you to run Hyper-V inside of a Hyper-V virtual machine. For example:

```
PS C:\Users\Administrator> Set-VMProcessor -VMName <vSRX_0109> -ExposeVirtualizationExtensions $true
```

**NOTE:** Nested virtualization can only be configured on a host running Microsoft Hyper-V Server 2016. In addition, Dynamic Memory must be disabled on the virtual machine containing the nested instance of Hyper-V.

10. Launch and power on the vSRX Virtual Firewall VM by using the Start-VM command, where Name is the name of the vSRX Virtual Firewall VM you created. For example:

```
PS C:\Users\Administrator> Start-VM -Name <vSRX_0109>
```

11. Configure the basic settings for the vSRX Virtual Firewall (see *Configure vSRX Using the CLI*).

## Release History Table

| Release     | Description                                                                                                                                                      |
|-------------|------------------------------------------------------------------------------------------------------------------------------------------------------------------|
| 15.1X49-D80 | Starting in Junos OS Release 15.1X49-D80 and Junos OS Release 17.3R1, you can deploy the vSRX Virtual Firewall only on Microsoft Hyper-V Server 2012 R2 or 2012. |

15.1X49-D100 | Starting in Junos OS Release 15.1X49-D100 and Junos OS Release 17.4R1, you can deploy the vSRX Virtual Firewall on Microsoft Hyper-V Server 2016.

---

## RELATED DOCUMENTATION

[Hyper-V Module for Windows PowerShell](#)

[Create a Virtual Machine in Hyper-V](#)

[Run Hyper-V in a Virtual Machine with Nested Virtualization](#)

# vSRX Virtual Firewall VM Management with Microsoft Hyper-V

## IN THIS CHAPTER

- [Configure vSRX Virtual Firewall Using the CLI | 205](#)
- [Configure vSRX Virtual Firewall Using the J-Web Interface | 207](#)
- [Add vSRX Virtual Firewall Interfaces | 211](#)
- [Power Down a vSRX Virtual Firewall VM with Hyper-V | 221](#)

## Configure vSRX Virtual Firewall Using the CLI

To configure the instance using the CLI:

1. Verify that the vSRX Virtual Firewall instance is powered on.
2. Log in as the root user (whose username is *root*). There is no password.
3. Start the CLI.

```
root#cli
root@>
```

4. Enter configuration mode.

```
configure
[edit]
root@#
```

5. Set the root authentication password by entering a *cleartext* password, an encrypted password, or an SSH public key string (*DSA* or *RSA*). The following is an example of a plain-text password. The CLI prompts you for the password and then encrypts it.

```
[edit]
root@# set system root-authentication plain-text-password
New password: password
Retype new password: password
```

6. Configure the hostname.

```
[edit]
root@# set system host-name host-name
```

7. Configure the management interface.

```
[edit]
root@# set interfaces fxp0 unit 0 family inet dhcp-client
```

8. Configure the traffic interfaces.

```
[edit]
root@# set interfaces ge-0/0/0 unit 0 family inet dhcp-client
```

9. Configure basic security zones and bind them to traffic interfaces.

```
[edit]
root@# set security zones security-zone trust interfaces ge-0/0/0.0
```

10. Verify the configuration changes.

```
[edit]
root@# commit check
configuration check succeeds
```

11. Commit the configuration to activate it on the instance.

```
[edit]
root@# commit
commit complete
```

**NOTE:** Certain Junos OS software features require a license to activate the feature. To enable a licensed feature, you need to purchase, install, manage, and verify a license key that corresponds to each licensed feature. To conform to software feature licensing requirements, you must purchase one license per feature per instance. The presence of the appropriate software unlocking key on your virtual instance allows you to configure and use the licensed feature. See [Managing Licenses for vSRX](#) for details.

## RELATED DOCUMENTATION

[CLI User Guide](#)

[Junos OS for SRX Series](#)

## Configure vSRX Virtual Firewall Using the J-Web Interface

### IN THIS SECTION

- [Access the J-Web Interface and Configuring vSRX Virtual Firewall | 207](#)
- [Apply the Configuration | 210](#)
- [Add vSRX Virtual Firewall Feature Licenses | 210](#)

### Access the J-Web Interface and Configuring vSRX Virtual Firewall

To configure vSRX Virtual Firewall using the *J-Web* Interface:

1. Launch the J-Web interface from a Web browser.



**NOTE:** You will be prompted to accept a system-generated certificate to access a vSRX Virtual Firewall VM using the J-Web interface.

2. Enter the vSRX Virtual Firewall out-of-band management (fxp0) interface IP address in the Address box.
3. Specify the username and password.
4. Click **Log In**, and select the **Configuration Wizards** tab from the left navigation panel. The J-Web Setup wizard page opens.
5. Click **Setup**.

You can use the Setup wizard to configure the vSRX Virtual Firewall VM or edit an existing configuration.

- Select **Edit Existing Configuration** if you have already configured the wizard using the factory mode.
- Select **Create New Configuration** to configure the vSRX Virtual Firewall VM using the wizard.

The following configuration options are available in the guided setup:

- Basic

Select **basic** to configure the vSRX Virtual Firewall VM name and user account information as shown in [Table 42 on page 208](#).

- Instance name and user account information

**Table 42: Instance Name and User Account Information**

| Field           | Description                                          |
|-----------------|------------------------------------------------------|
| Instance name   | Type the name of the vSRX Virtual Firewall instance. |
| Root password   | Create a default root user password.                 |
| Verify password | Verify the default root user password.               |

Table 42: Instance Name and User Account Information (Continued)

| Field    | Description                                                                                                                                                                                                                                                                                                                                                                                                                                                                                                                                                                                                      |
|----------|------------------------------------------------------------------------------------------------------------------------------------------------------------------------------------------------------------------------------------------------------------------------------------------------------------------------------------------------------------------------------------------------------------------------------------------------------------------------------------------------------------------------------------------------------------------------------------------------------------------|
| Operator | <p>Add an optional administrative account in addition to the root account.</p> <p>User role options include:</p> <ul style="list-style-type: none"> <li>• <b>Super User:</b> This user has full system administration rights and can add, modify, and delete settings and users.</li> <li>• <b>Operator:</b> This user can perform system operations such as a system reset but cannot change the configuration or add or modify users.</li> <li>• <b>Read only:</b> This user can only access the system and view the configuration.</li> <li>• <b>Disabled:</b> This user cannot access the system.</li> </ul> |

- Select either **Time Server** or **Manual**. [Table 43 on page 209](#) lists the system time options.

Table 43: System Time Options

| Field              | Description                                                                                             |
|--------------------|---------------------------------------------------------------------------------------------------------|
| <b>Time Server</b> |                                                                                                         |
| Host Name          | Type the hostname of the time server. For example: <b>ntp.example.com</b> .                             |
| IP                 | Type the IP address of the time server in the IP address entry field. For example: <b>192.0.2.254</b> . |

**NOTE:** You can enter either the hostname or the IP address.

**Manual**

|      |                                                                    |
|------|--------------------------------------------------------------------|
| Date | Click the current date in the calendar.                            |
| Time | Set the hour, minute, and seconds. Choose <b>AM</b> or <b>PM</b> . |

**Time Zone (mandatory)**

**Table 43: System Time Options (Continued)**

| Field     | Description                                                                   |
|-----------|-------------------------------------------------------------------------------|
| Time Zone | Select the time zone from the list. For example: GMT Greenwich Mean Time GMT. |

- Expert
  - a. Select **Expert** to configure the basic options as well as the following advanced options:
    - Four or more internal zones
    - Internal zone services
    - Application of security policies between internal zones
  - b. Click the **Need Help** icon for detailed configuration information.

You see a success message after the basic configuration is complete.

## Apply the Configuration

To apply the configuration settings for vSRX Virtual Firewall:

1. Review and ensure that the configuration settings are correct, and click **Next**. The Commit Configuration page appears.
2. Click **Apply Settings** to apply the configuration changes to vSRX Virtual Firewall.
3. Check the connectivity to vSRX Virtual Firewall, as you might lose connectivity if you have changed the management zone IP. Click the URL for reconnection instructions on how to reconnect to the instance.
4. Click **Done** to complete the setup.

After successful completion of the setup, you are redirected to the J-Web interface.



**CAUTION:** After you complete the initial setup, you can relaunch the J-Web Setup wizard by clicking **Configuration>Setup**. You can either edit an existing configuration or create a new configuration. If you create a new configuration, the current configuration in vSRX Virtual Firewall will be deleted.

## Add vSRX Virtual Firewall Feature Licenses

Certain Junos OS software features require a license to activate the feature. To enable a licensed feature, you need to purchase, install, manage, and verify a license key that corresponds to each licensed

feature. To conform to software feature licensing requirements, you must purchase one license per feature per instance. The presence of the appropriate software unlocking key on your virtual instance allows you to configure and use the licensed feature.

See [Managing Licenses for vSRX](#) for details.

## Add vSRX Virtual Firewall Interfaces

### IN THIS SECTION

- [Add Virtual Switches | 212](#)
- [Configure the vSRX Virtual Firewall to Use a VLAN | 219](#)

The Hyper-V virtual switch is a software-based Layer 2 Ethernet network switch that connects VMs to either physical or virtual networks. A virtual switch can be configured from Hyper-V Manager or Windows PowerShell. The Hyper-V host uses the virtual switches to connect virtual machines to the internet through the host computer's network connection. You configure networking for the vSRX Virtual Firewall by adding, removing, and modifying its associated network adapters in the Hyper-V host as necessary.

**NOTE:** To perform this procedure, you must have appropriate permissions. Contact your Virtual Server administrator to request the proper permissions to add a virtual switch and network adapter..

For the vSRX Virtual Firewall VM, you pair a network adapter with a virtual switch for the vSRX Virtual Firewall to receive and transmit traffic. You map network adapters to the specific vSRX Virtual Firewall interfaces: Network adapter 1 is mapped to the fxp0 (out-of-band management) interface, network adapter 2 is mapped to the ge-0/0/0 (revenue) interface, network adapter 3 is mapped to ge-0/0/1, and so on (see *Requirements for vSRX on Microsoft Hyper-V*). Hyper-V supports a maximum of eight network adapters.

**NOTE:** When adding virtual switches, there are no limits imposed by Hyper-V. The practical limit depends on the available computing resources.

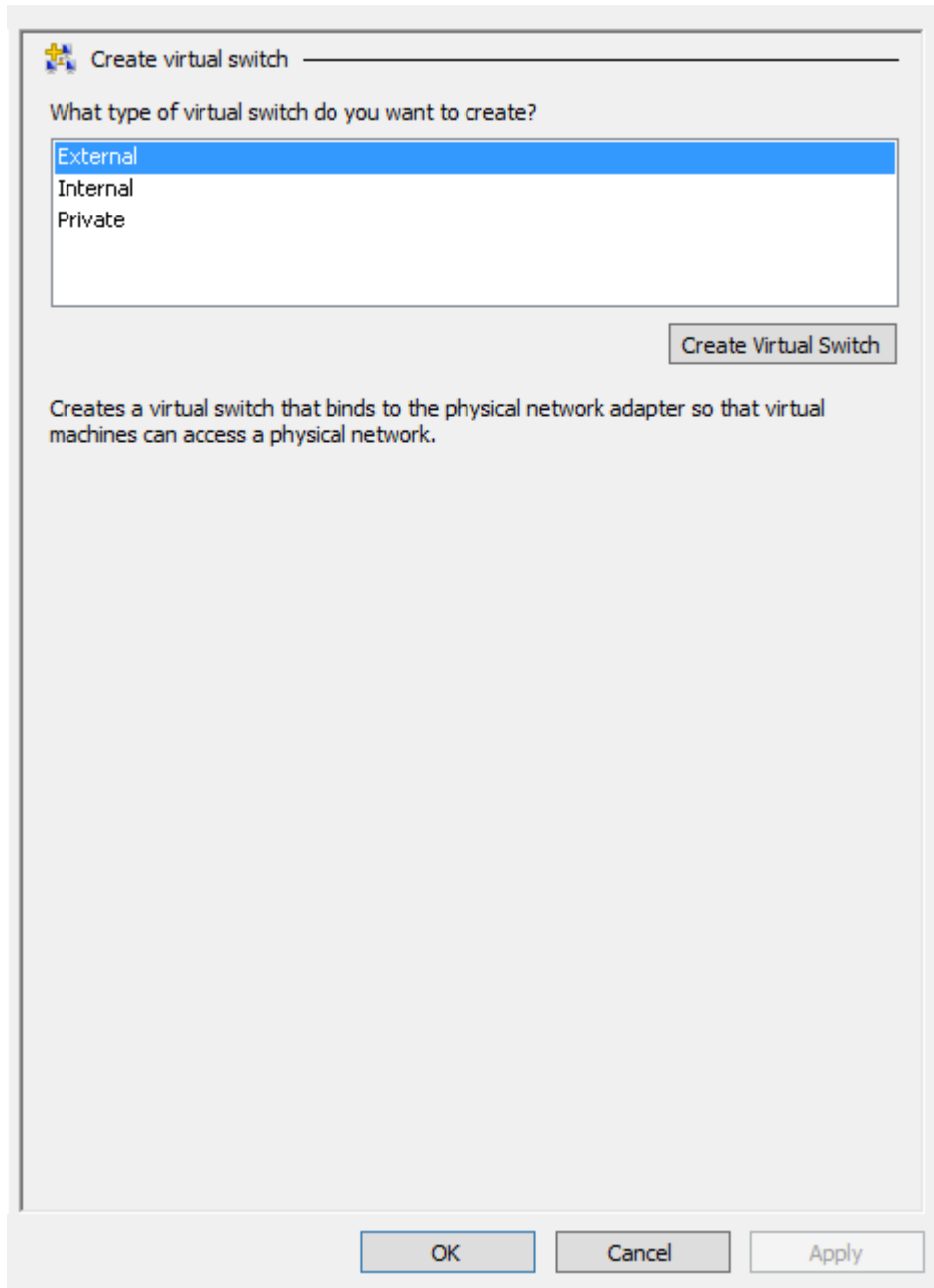
This section includes the following topics on adding vSRX Virtual Firewall interfaces in Hyper-V:

## Add Virtual Switches

To add virtual switches for the vSRX Virtual Firewall VM using the Virtual Switch Manager in the Hyper-V Manager:

1. Open the Hyper-V Manager by selecting **Start > Administrative Tools > Hyper-V Manager**.
2. Select **Action > Virtual Switch Manager**. The Virtual Switch Manager appears.
3. Under the Virtual Switches section, select **New virtual network switch**. The Create Virtual Switch pane appears (see [Figure 41 on page 213](#)).

Figure 41: Create Virtual Switch Pane



4. Choose the type of virtual switch to create:
  - External—Gives virtual machines access to a physical network to communicate with servers and clients on an external network. It allows virtual machines on the same Hyper-V server to communicate with each other.
  - Internal—Allows communication between virtual machines on the same Hyper-V server, and between the virtual machines and the management host operating system.

- **Private**—Allows communication only between virtual machines on the same Hyper-V server. A private network is isolated from all external network traffic on the Hyper-V server. This type of network is useful when you must create an isolated networking environment, like an isolated test domain.

In most cases when adding a vSRX Virtual Firewall network adapter, select **External** as the type of virtual switch. Internal and private virtual switches are intended to keep network traffic within the Hyper-V server.

**NOTE:** For the fxp0 (out-of-band management) interface, connect it to External virtual switch, which could connect to an external network.

For the ge-0/0/0 (revenue port) interface, if only communication between VMs in the same Hyper-V server is needed, Internal or Private virtual switch should be sufficient. However, if communication between the VM and an external network is needed, connect it to External virtual switch.

5. Select **Create Virtual Switch**. The Virtual Switch Properties pane appears (see [Figure 42 on page 215](#)).

Figure 42: Virtual Switch Properties Pane

Virtual Switch Properties

Name:

Notes:

Connection type

What do you want to connect this virtual switch to?

External network:

Allow management operating system to share this network adapter

Enable single-root I/O virtualization (SR-IOV)

Internal network

Private network

VLAN ID

Enable virtual LAN identification for management operating system

The VLAN identifier specifies the virtual LAN that the management operating system will use for all network communications through this network adapter. This setting does not affect virtual machine networking.

**i** SR-IOV can only be configured when the virtual switch is created. An external virtual switch with SR-IOV enabled cannot be converted to an internal or private switch.

6. Specify a name for the virtual switch.
7. Choose the physical network interface card b(NIC) that you want to use (only a requirement when you select **External**).
8. Isolate network traffic from the management Hyper-V host operating system or other virtual machines that share the same virtual switch by selecting **Enable virtual LAN identification**. You can change the VLAN ID to any number or leave the default. See "[Configure the vSRX Virtual Firewall to Use a VLAN](#)" on page 219 for details.



9. Click **OK**, then click **Yes** to apply networking changes and to close the Virtual Switch Manager window.
10. If necessary, repeat Steps 3 through 9 to add additional network adapters for use by the vSRX Virtual Firewall VM.
11. Right-click the vSRX Virtual Firewall VM and select **Settings** from the context menu. From the Settings dialog box, under the Hardware section, click **Network Adapter**. The Network Adapter pane appears (see [Figure 43 on page 217](#)).
12. From the Virtual switch drop-down list, select the **virtual switch** that you want to assign to this network adapter. See *Requirements for vSRX on Microsoft Hyper-V* for a summary of interface names and mappings for a vSRX Virtual Firewall VM.

Figure 43: Adding Virtual Switch to Network Adapter Example

**Network Adapter**

Specify the configuration of the network adapter or remove the network adapter.

Virtual switch:

**VLAN ID**

Enable virtual LAN identification

The VLAN identifier specifies the virtual LAN that this virtual machine will use for all network communications through this network adapter.

**Bandwidth Management**

Enable bandwidth management

Specify how this network adapter utilizes network bandwidth. Both Minimum Bandwidth and Maximum Bandwidth are measured in Megabits per second.

Minimum bandwidth:  Mbps

Maximum bandwidth:  Mbps

**i** To leave the minimum or maximum unrestricted, specify 0 as the value.

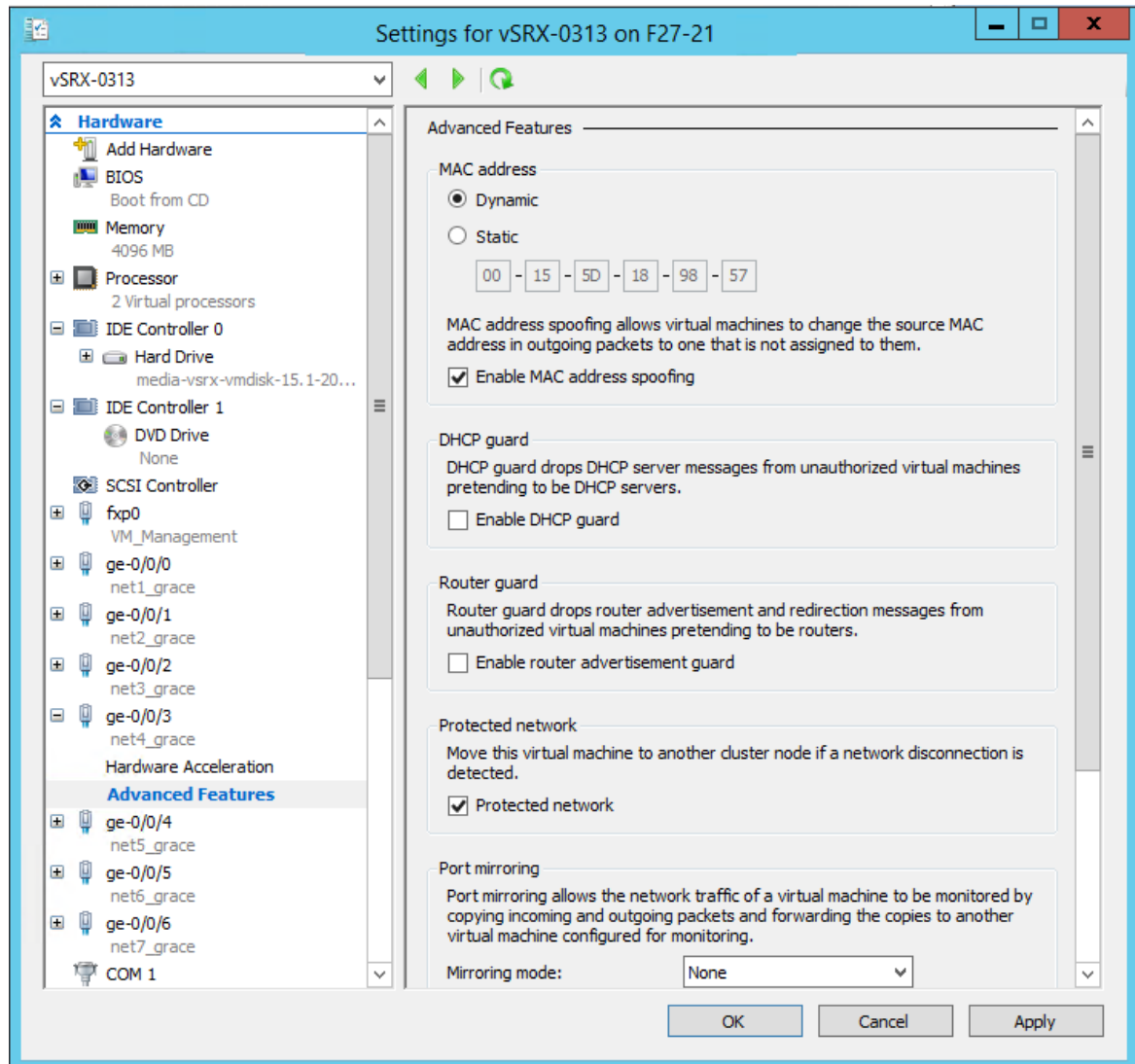
To remove the network adapter from this virtual machine, click Remove.

**i** Use a legacy network adapter instead of this network adapter to perform a network-based installation of the guest operating system or when integration services are not installed in the guest operating system.

13. If a network adapter is to be used as an interface for Layer 2 mode support on the vSRX Virtual Firewall, then from the Network Adapter pane select **Advanced Features**. Select the **Enable MAC address spoofing** check box to enable the MAC address spoofing function for the network adapter (see [Figure 44 on page 218](#)).

MAC address spoofing allows each network adapter to change its source MAC address for outgoing packets to one that is not assigned to them. Enabling MAC address spoofing ensures those packets are not dropped by the network adapter if the source MAC address fails to match the outgoing interface MAC address.

Figure 44: Network Adapter Enable MAC Address Spoofing Example



14. Click **Apply** and **OK** to save the changes in the Settings dialog box.
15. Launch and power on the vSRX Virtual Firewall instance in the Hyper-V Manager by selecting the vSRX Virtual Firewall VM from the list of virtual machines, and then right-click and select **Start** from the context menu (or select **Action > Start**).

#### SEE ALSO

- [Create a Virtual Switch for Hyper-V Virtual Machines](#)
- [Create a Virtual Network](#)

## Configure the vSRX Virtual Firewall to Use a VLAN

Hyper-V supports the configuration of VLANs on a network adapter in the host computer. For each network adapter that you configure for the vSRX Virtual Firewall VM, if required, you can add a VLAN identifier to specify the VLAN that the vSRX Virtual Firewall VM will use for all network communications through the network adapter.

By default, Hyper-V enables trunk mode for a VLAN. Trunk mode allows multiple VLAN IDs to share a connection between the physical network adapter and the physical network.

To give the vSRX Virtual Firewall VM external access on the virtual network in multiple VLANs, you will need to configure the port on the physical network to be in trunk mode. You will also need to know the specific VLANs that are used and all of the VLAN IDs used by the virtual machines that the virtual network supports.

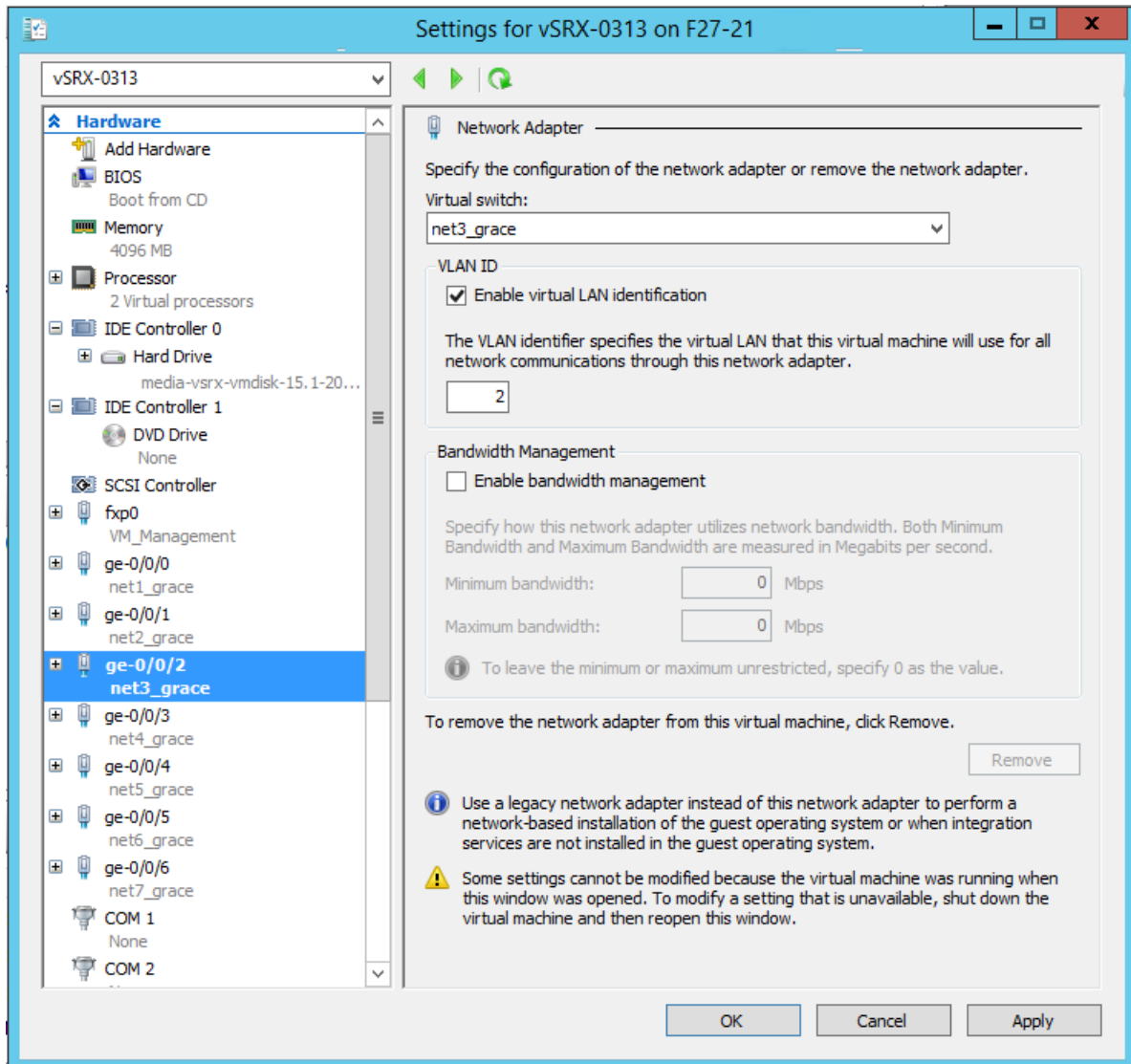
To utilize a Hyper-V VLAN, ensure that you are using a physical network adapter that supports 802.1q VLAN tagging. By default, the virtual network adapter in Hyper-V is in untagged mode and you might need to enable the feature on a virtual network adapter.

**NOTE:** By using Windows PowerShell, you can determine the mode of the vNIC (`Get-VmNetworkAdapterVlan` command) and change the mode of the vNIC (`Set-VmNetworkAdapterVlan` command). See [Get-VMNetworkAdapterVlan](#) and [Set-VMNetworkAdapterVlan](#) for details on both Windows PowerShell virtual network adapter commands.

To add a VLAN for a vSRX Virtual Firewall VM virtual network adapter:

1. Open the Hyper-V Manager by selecting **Start > Administrative Tools > Hyper-V Manager**.
2. Right-click the vSRX Virtual Firewall VM and select **Settings** from the context menu.
3. From the Settings dialog box, under the Hardware section, select the network adapter connected to the external virtual network. The Network Adapter pane appears.
4. Select **Enable virtual LAN identification**, and then enter the VLAN ID you intend to use (see [Figure 45 on page 220](#)). You can change the VLAN ID to any number or leave the default. This is the VLAN identification number that the vSRX Virtual Firewall will use for all network communication through this network adapter.

Figure 45: Enable VLAN Identification Example



5. Click **OK**, and then click **Yes** to apply networking changes.
6. If necessary, repeat Steps 3 through 5 to add VLAN identification to additional network adapters in use by the vSRX Virtual Firewall VM.

## SEE ALSO

[Hyper-V: Configure VLANs and VLAN Tagging](#)

[Understanding Hyper-V VLANs](#)

## Power Down a vSRX Virtual Firewall VM with Hyper-V

In situations where you need to modify the vSRX Virtual Firewall VM settings from Hyper-V, you must first perform a graceful shut down of the vSRX Virtual Firewall VM using the **Shut Down** command. The vSRX Virtual Firewall VM performs an orderly closing of all programs and attempts to shut off power to avoid data loss.

**NOTE:** If you are using Microsoft PowerShell, use the `Stop-VM` command to perform a graceful shutdown of the vSRX Virtual Firewall VM.

To gracefully shut down the vSRX Virtual Firewall instance on the Hyper-V host computer:

1. Log onto your Hyper-V host computer using the Administrator account.
2. Open the Hyper-V Manager by selecting **Start > Administrative Tools > Hyper-V Manager**.
3. Power down the vSRX Virtual Firewall instance in the Hyper-V Manager by selecting the vSRX Virtual Firewall VM from the list of virtual machines, and then right-click and select **Shut Down** from the context menu (or select **Action > Shut Down**).
4. Power on the vSRX Virtual Firewall instance in the Hyper-V Manager by selecting the vSRX Virtual Firewall VM from the list of virtual machines, and then right-click and select **Start** from the context menu (or select **Action > Start**).

**NOTE:** If you are using Microsoft PowerShell, use the `Start-VM` command to start the vSRX Virtual Firewall VM.

# Configure vSRX Virtual Firewall Chassis Clusters

## IN THIS CHAPTER

- [vSRX Virtual Firewall Cluster Staging and Provisioning in Hyper-V | 222](#)
- [Configure a vSRX Virtual Firewall Chassis Cluster in Junos OS | 230](#)

## vSRX Virtual Firewall Cluster Staging and Provisioning in Hyper-V

### IN THIS SECTION

- [Deploying the VMs and Additional Network Adapters in Hyper-V | 223](#)
- [Creating the Control Link Connection in Hyper-V | 223](#)
- [Creating the Fabric Link Connection in Hyper-V | 226](#)
- [Creating the Data Interfaces Using Hyper-V | 227](#)
- [Prestaging the Configuration from the Console | 228](#)
- [Connecting and Installing the Staging Configuration | 229](#)

Staging and provisioning a vSRX Virtual Firewall cluster on a Hyper-V host computer includes the following tasks:

**NOTE:** Starting in Junos OS Release 15.1X49-D100 and Junos OS Release 17.4R1, support for chassis clustering to provide network node redundancy is only available on Windows Hyper-V Server 2016.

## Deploying the VMs and Additional Network Adapters in Hyper-V

The vSRX Virtual Firewall cluster uses three interfaces exclusively for clustering (the first two are predefined):

- Out-of-band management interface (fxp0).
- Cluster control link (em0).
- Cluster fabric links (fab0 and fab1). For example, you can specify ge-0/0/0 as fab0 on node0 and ge-7/0/0 as fab1 on node1.

A cluster requires three interfaces (two for the cluster and one for management) and additional interfaces to forward data. This section outlines how to create the control link and fabric link connections, and to map all data interfaces to network adapters.

**NOTE:** For an overview on the procedure to add virtual switches and map the virtual switch to a network adapter, see *Add vSRX Interfaces*

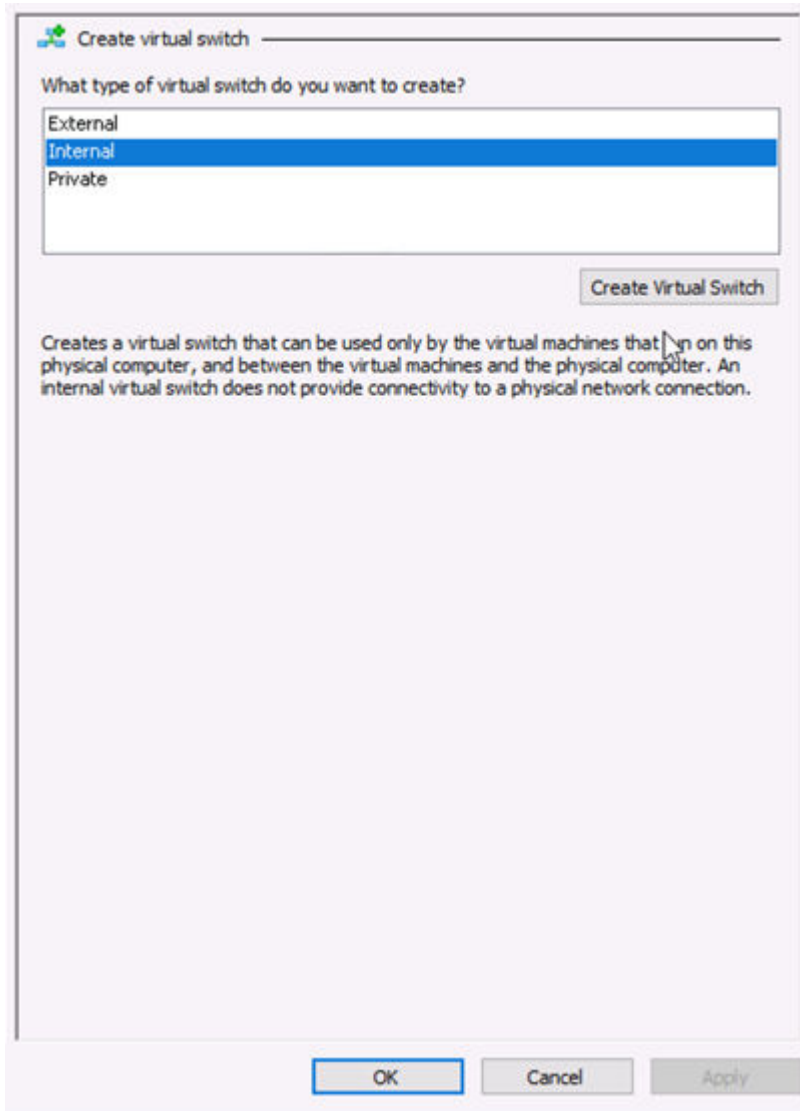
### Creating the Control Link Connection in Hyper-V

To connect the control interface through the control link virtual switch using Hyper-V Manager:

1. Open the Hyper-V Manager by selecting **Start > Administrative Tools > Hyper-V Manager**.
2. From the Hyper-V Manager, select **Action > Virtual Switch Manager**. The Virtual Switch Manager appears.
3. Under the Virtual Switches section, select **New virtual network switch**. The Create Virtual Switch pane appears (see [Figure 46 on page 224](#)).



Figure 46: Create Virtual Switch Pane



4. Select **Internal** as the type of virtual switch. Internal allows communication between virtual machines on the same Hyper-V server, and between the virtual machines and the management host operating system.
5. Select **Create Virtual Switch**. The Virtual Switch Properties page appears (see [Figure 47 on page 225](#)).

Figure 47: Virtual Switch Properties Pane

**Virtual Switch Properties**

Name:  
ctrl\_link

Notes:

Connection type  
What do you want to connect this virtual switch to?

External network:  
Broadcom NetXtreme Gigabit Ethernet  
 Allow management operating system to share this network adapter  
 Enable single-root I/O virtualization (SR-IOV)

Internal network  
 Private network

VLAN ID  
 Enable virtual LAN identification for management operating system  
The VLAN identifier specifies the virtual LAN that the management operating system will use for all network communications through this network adapter. This setting does not affect virtual machine networking.  
2

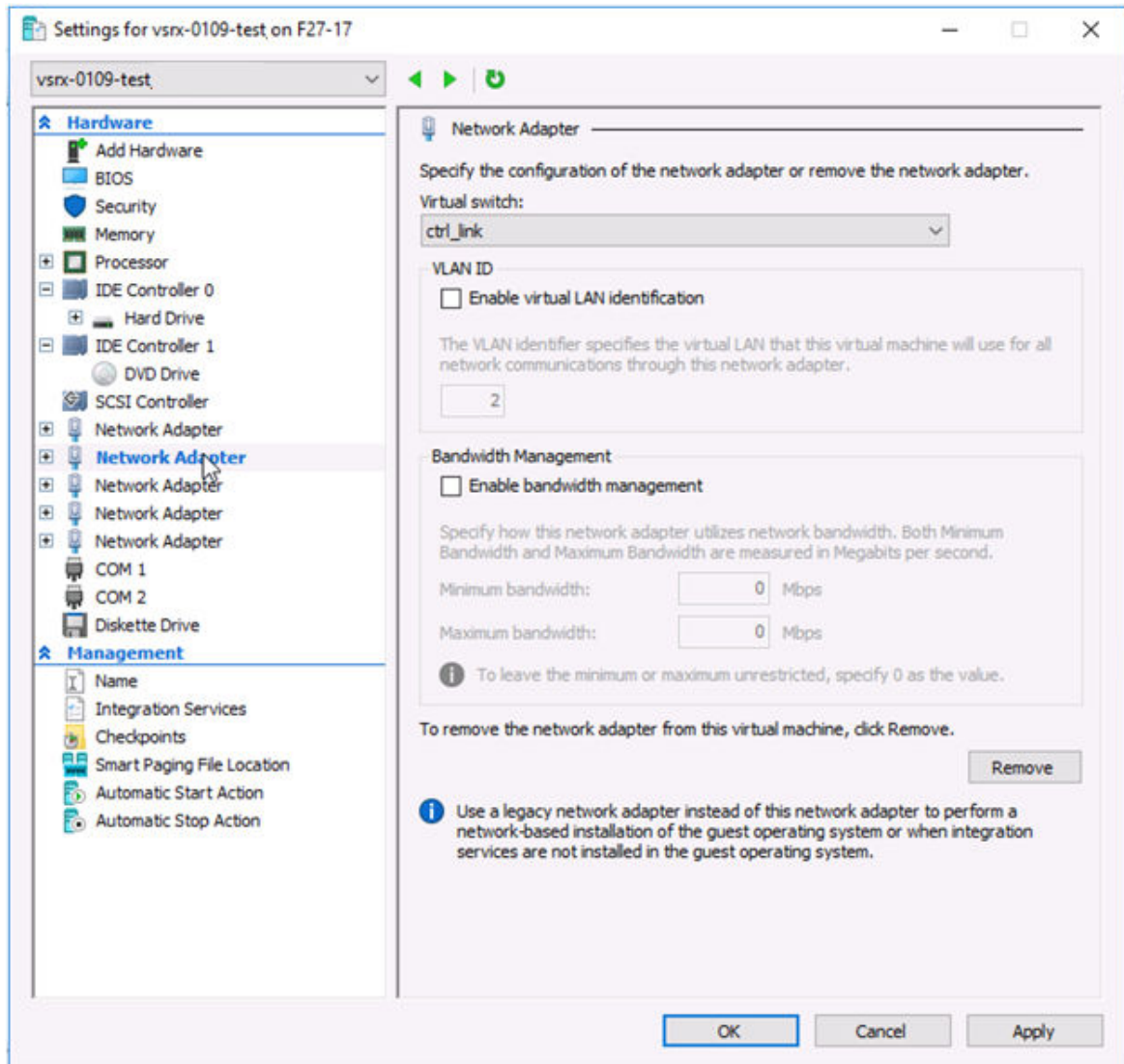
Remove

**i** SR-IOV can only be configured when the virtual switch is created. An external virtual switch with SR-IOV enabled cannot be converted to an internal or private switch.

OK Cancel Apply

6. Specify a name for the control link virtual switch. Leave the other virtual switch properties at their default settings.
7. Click **OK** and then click **Yes** to apply networking changes and to close the Virtual Switch Manager window.
8. Right-click the vSRX Virtual Firewall VM and select **Settings** from the context menu. From the Settings dialog for the vSRX Virtual Firewall VM, the Hardware section, click **Network Adapter**. The Network Adapter pane appears (see [Figure 48 on page 226](#)). Assign network adapter 2 as the control link (em0) virtual switch.

Figure 48: Adding Virtual Switch to Network Adapter Pane Example



9. From the Virtual switch drop-down assign **ctrl\_link** to the control link virtual switch.
10. From the Network Adapter pane, select **Advanced Features**. Select the **Enable MAC address spoofing** check box to enable the MAC address spoofing function for the network adapter. MAC address spoofing is a requirement for the control link interface included in the redundancy groups.
11. Click **OK** and then click **Yes** to apply network adapter changes.

## Creating the Fabric Link Connection in Hyper-V

To connect the fabric interface through the fabric link virtual switch using Hyper-V Manager

1. If necessary, open the Hyper-V Manager by selecting **Start > Administrative Tools > Hyper-V Manager**.

2. From the Hyper-V Manager, select **Action > Virtual Switch Manager**. The Virtual Switch Manager appears.
3. Under the Virtual Switches section, select **New virtual network switch**. The Create Virtual Switch pane appears (see [Figure 46 on page 224](#)).
4. Select **Internal** as the type of virtual switch. Internal allows communication between virtual machines on the same Hyper-V server, and between the virtual machines and the management host operating system.
5. Select **Create Virtual Switch**. The Virtual Switch Properties page appears (see [Figure 47 on page 225](#)).
6. Specify a name for the fabric link virtual switch. Leave the other virtual switch properties at their default settings.
7. Click **OK** and then click **Yes** to apply networking changes and to close the Virtual Switch Manager window.
8. Right-click the vSRX Virtual Firewall VM and select **Settings** from the context menu. From the Settings dialog for the vSRX Virtual Firewall VM, the Hardware section, click **Network Adapter** to access the Network Adapter pane. The Network Adapter pane appears (see [Figure 48 on page 226](#)). Assign network adapter 3 as the fabric link (fab 0 or fab 1) virtual switch.
9. From the Virtual switch drop-down assign **fab0** or **fab1** to the fabric link virtual switch.
10. From the Network Adapter pane, select **Advanced Features**. Select the **Enable MAC address spoofing** check box to enable the MAC address spoofing function for the network adapter. MAC address spoofing is a requirement for the fabric link interface included in the redundancy groups.
11. Click **OK** and then click **Yes** to apply network adapter changes.

## Creating the Data Interfaces Using Hyper-V

To map all data interfaces to the desired network adapters:

1. If necessary, open the Hyper-V Manager by selecting **Start > Administrative Tools > Hyper-V Manager**.
2. From the Hyper-V Manager, select **Action > Virtual Switch Manager**. The Virtual Switch Manager appears.
3. Under the Virtual Switches section, select **New virtual network switch**. The Create Virtual Switch pane appears (see [Figure 46 on page 224](#)).
4. Select **Internal** as the type of virtual switch. Internal allows communication between virtual machines on the same Hyper-V server, and between the virtual machines and the management host operating system.
5. Select **Create Virtual Switch**. The Virtual Switch Properties page appears (see [Figure 47 on page 225](#)).
6. Specify a name for the data interface virtual switch. Leave the other virtual switch properties at their default settings.

7. Click **OK** and then click **Yes** to apply networking changes and to close the Virtual Switch Manager window.
8. Right-click the vSRX Virtual Firewall VM and select **Settings** from the context menu. From the Settings dialog for the vSRX Virtual Firewall VM, the Hardware section, click **Network Adapter** to access the Network Adapter pane. The Network Adapter pane appears (see [Figure 48 on page 226](#)). Assign network adapter 3 as the data interface (fab 0 or fab 1) virtual switch.
9. From the Virtual switch drop-down assign **data interface** to the virtual switch.
10. From the Network Adapter pane, select **Advanced Features**. Select the **Enable MAC address spoofing** check box to enable the MAC address spoofing function for the network adapter. MAC address spoofing is a requirement for the data interfaces included in the redundancy groups.
11. Click **OK** and then click **Yes** to apply network adapter changes. The data interface will be connected through the data virtual switch.

### Prestaging the Configuration from the Console

The following procedure explains the configuration commands required to set up the vSRX Virtual Firewall chassis cluster. The procedure powers up both nodes, adds the configuration to the cluster, and allows SSH remote access.

1. Log in as the root user. There is no password.
2. Start the CLI.

```
root#cli
root@>
```

3. Enter configuration mode.

```
configure
[edit]
root@#
```

4. Copy the following commands and paste them into the CLI:

```
set groups node0 interfaces fxp0 unit 0 family inet address 192.168.42.81/24
set groups node0 system hostname vsrx-node0
set groups node1 interfaces fxp0 unit 0 family inet address 192.168.42.82/24
set groups node1 system hostname vsrx-node1
set apply-groups "${node}"
```

5. Set the root authentication password by entering a cleartext password, an encrypted password, or an SSH public key string (DSA or RSA).

```
root@# set system root-authentication plain-text-password
New password: password
Retype new password: password
set system root-authentication encrypted-password "$ABC123"
```

6. To enable SSH remote access:

```
user@host#set system services ssh
```

7. To enable IPv6:

```
user@host#set security forwarding-options family inet6 mode flow-based
```

This step is optional and requires a system reboot.

8. Commit the configuration to activate it on the device.

```
user@host#commit
commit complete
```

9. When you have finished configuring the device, exit configuration mode.

```
user@host#exit
```

## Connecting and Installing the Staging Configuration

After the vSRX Virtual Firewall cluster initial setup, set the cluster ID and the node ID, as described in *Configure a vSRX Chassis Cluster in Junos OS*.

After reboot, the two nodes are reachable on interface fxp0 with SSH. If the configuration is operational, the `show chassis cluster status` command displays output similar to that shown in the following sample output.

```
vSRX Virtual Firewall> show chassis cluster status
```

```
Cluster ID: 1
```

| Node                                    | Priority | Status    | Preempt | Manual failover |
|-----------------------------------------|----------|-----------|---------|-----------------|
| Redundancy group: 0 , Failover count: 1 |          |           |         |                 |
| node0                                   | 100      | secondary | no      | no              |
| node1                                   | 150      | primary   | no      | no              |
| Redundancy group: 1 , Failover count: 1 |          |           |         |                 |
| node0                                   | 100      | secondary | no      | no              |
| node1                                   | 150      | primary   | no      | no              |

A cluster is healthy when the primary and secondary nodes are present and both have a priority greater than 0.

### Release History Table

| Release      | Description                                                                                                                                                                                |
|--------------|--------------------------------------------------------------------------------------------------------------------------------------------------------------------------------------------|
| 15.1X49-D100 | Starting in Junos OS Release 15.1X49-D100 and Junos OS Release 17.4R1, support for chassis clustering to provide network node redundancy is only available on Windows Hyper-V Server 2016. |

## Configure a vSRX Virtual Firewall Chassis Cluster in Junos OS

### IN THIS SECTION

- [Chassis Cluster Overview | 230](#)
- [Enable Chassis Cluster Formation | 231](#)
- [Chassis Cluster Quick Setup with J-Web | 237](#)
- [Manually Configure a Chassis Cluster with J-Web | 237](#)

### Chassis Cluster Overview

*Chassis cluster* groups a pair of the same kind of vSRX Virtual Firewall instances into a cluster to provide network node redundancy. The devices must be running the same Junos OS release. You connect the control virtual interfaces on the respective nodes to form a *control plane* that synchronizes the configuration and Junos OS kernel state. The control link (a *virtual network* or *vSwitch*) facilitates the redundancy of interfaces and services. Similarly, you connect the *data plane* on the respective nodes

over the fabric virtual interfaces to form a unified data plane. The fabric link (a virtual network or vSwitch) allows for the management of cross-node flow processing and for the management of session redundancy.

The control plane software operates in active/passive mode. When configured as a chassis cluster, one node acts as the primary device and the other as the secondary device to ensure stateful failover of processes and services in the event of a system or hardware failure on the primary device. If the primary device fails, the secondary device takes over processing of control plane traffic.

**NOTE:** If you configure a chassis cluster on vSRX Virtual Firewall nodes across two physical hosts, disable igmp-snooping on the bridge that each host physical interface belongs to that the control vNICs use. This ensures that the control link heartbeat is received by both nodes in the chassis cluster.

The chassis cluster data plane operates in active/active mode. In a chassis cluster, the data plane updates session information as traffic traverses either device, and it transmits information between the nodes over the fabric link to guarantee that established sessions are not dropped when a failover occurs. In active/active mode, traffic can enter the cluster on one node and exit from the other node.

Chassis cluster functionality includes:

- Resilient system architecture, with a single active control plane for the entire cluster and multiple *Packet Forwarding Engines*. This architecture presents a single device view of the cluster.
- Synchronization of configuration and dynamic runtime states between nodes within a cluster.
- Monitoring of physical interfaces, and failover if the failure parameters cross a configured threshold.
- Support for generic routing encapsulation (*GRE*) and IP-over-IP (IP-IP) tunnels used to route encapsulated IPv4 or *IPv6* traffic by means of two internal interfaces, gr-0/0/0 and ip-0/0/0, respectively. Junos OS creates these interfaces at system startup and uses these interfaces only for processing GRE and IP-IP tunnels.

At any given instant, a cluster node can be in one of the following states: hold, primary, secondary-hold, secondary, ineligible, or disabled. Multiple event types, such as interface monitoring, Services Processing Unit (SPU) monitoring, failures, and manual failovers, can trigger a state transition.

## Enable Chassis Cluster Formation

### IN THIS SECTION

- [Chassis Cluster Provisioning on vSRX Virtual Firewall](#) | 232



- [Interface Naming and Mapping | 233](#)
- [Enabling Chassis Cluster Formation | 235](#)

### Chassis Cluster Provisioning on vSRX Virtual Firewall

Setting up the connectivity for chassis cluster on vSRX Virtual Firewall instances is similar to physical SRX Series Firewalls. The vSRX Virtual Firewall VM uses virtual network (or vswitch) for virtual NIC (such as VMXNET3 or virtio).

Chassis cluster requires the following direct connections between the two vSRX Virtual Firewall instances:

- Control link, or virtual network, which acts in active/passive mode for the control plane traffic between the two vSRX Virtual Firewall instances
- Fabric link, or virtual network, which is used for real-time session synchronization between the nodes. In active/active mode, this link is also used for carrying data traffic between the two vSRX Virtual Firewall instances.

**NOTE:** Note: You can optionally create two fabric links for more redundancy.

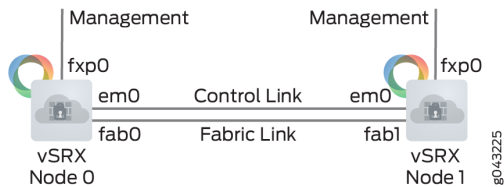
The vSRX Virtual Firewall cluster uses the following interfaces:

- Out-of-band Management interface (fxp0)
- Cluster control interface (em0)
- Cluster fabric interface (fab0 on node0, fab1 on node1)

**NOTE:** The control interface must be the second vNIC. For the fabric link you can use any revenue port (ge- ports). You can optionally configure a second fabric link for increased redundancy.

[Figure 27 on page 163](#) shows chassis cluster formation with vSRX Virtual Firewall instances.

**Figure 49: vSRX Virtual Firewall Chassis Cluster**



vSRX Virtual Firewall supports chassis cluster using the virtio driver and SR-IOV interfaces, with the following considerations:

- When you enable chassis cluster, you must also enable jumbo frames (MTU size = 9000) to support the fabric link on the virtio network interface.
- If you configure a chassis cluster across two physical hosts, disable igmp-snooping on each host physical interface that the vSRX Virtual Firewall control link uses to ensure that the control link heartbeat is received by both nodes in the chassis cluster.

```
host0S# echo 0 > /sys/devices/virtual/net/<bridge-name>/bridge/multicast_snooping
```

- After chassis cluster is enabled, the vSRX Virtual Firewall instance maps the second vNIC to the control link automatically, and its name will be changed from ge-0/0/0 to em0.
- You can use any other vNICs for the fabric link/links. (See ["Interface Naming and Mapping" on page 164](#))

For virtio interfaces, link status update is not supported. The link status of virtio interfaces is always reported as Up. For this reason, a vSRX Virtual Firewall instance using virtio and chassis cluster cannot receive link up and link down messages from virtio interfaces.

The virtual network MAC aging time determines the amount of time that an entry remains in the MAC table. We recommend that you reduce the MAC aging time on the virtual networks to minimize the downtime during failover.

For example, you can use the `brctl setageing bridge 1` command to set aging to 1 second for the Linux bridge.

You configure the virtual networks for the control and fabric links, then create and connect the control interface to the control virtual network and the fabric interface to the fabric virtual network.

### Interface Naming and Mapping

Each network adapter defined for a vSRX Virtual Firewall is mapped to a specific interface, depending on whether the vSRX Virtual Firewall instance is a standalone VM or one of a cluster pair for high availability. The interface names and mappings in vSRX Virtual Firewall are shown in Table 1 and Table 2.

Note the following:

- In standalone mode:
  - fxp0 is the out-of-band management interface.
  - ge-0/0/0 is the first traffic (revenue) interface.
- In cluster mode:
  - fxp0 is the out-of-band management interface.
  - em0 is the cluster control link for both nodes.
  - Any of the traffic interfaces can be specified as the fabric links, such as ge-0/0/0 for fab0 on node 0 and ge-7/0/0 for fab1 on node 1.

The interface names and mappings for a standalone vSRX Virtual Firewall VM can be seen in [Table 29 on page 165](#) and for a vSRX Virtual Firewall VM in cluster mode the same is shown in [Table 30 on page 165](#). You can see that in the cluster mode, the em0 port is inserted between the fxp0 and ge-0/0/0 positions, which makes the revenue port numbers shift up one vNIC location.

**Table 44: Interface Names for a Standalone vSRX Virtual Firewall VM**

| Network Adapter | Interface Names |
|-----------------|-----------------|
| 1               | fxp0            |
| 2               | ge-0/0/0        |
| 3               | ge-0/0/1        |
| 4               | ge-0/0/2        |
| 5               | ge-0/0/3        |
| 6               | ge-0/0/4        |
| 7               | ge-0/0/5        |
| 8               | ge-0/0/6        |

Table 45: Interface Names for a vSRX Virtual Firewall Cluster Pair

| Network Adapter | Interface Names                        |
|-----------------|----------------------------------------|
| 1               | fxp0 (node 0 and 1)                    |
| 2               | em0 (node 0 and 1)                     |
| 3               | ge-0/0/0 (node 0)<br>ge-7/0/0 (node 1) |
| 4               | ge-0/0/1 (node 0)<br>ge-7/0/1 (node 1) |
| 5               | ge-0/0/2 (node 0)<br>ge-7/0/2 (node 1) |
| 6               | ge-0/0/3 (node 0)<br>ge-7/0/3 (node 1) |
| 7               | ge-0/0/4 (node 0)<br>ge-7/0/4 (node 1) |
| 8               | ge-0/0/5 (node 0)<br>ge-7/0/5 (node 1) |

### Enabling Chassis Cluster Formation

You create two vSRX Virtual Firewall instances to form a chassis cluster, and then you set the cluster ID and node ID on each instance to join the cluster. When a vSRX Virtual Firewall VM joins a cluster, it becomes a node of that cluster. With the exception of unique node settings and management IP addresses, nodes in a cluster share the same configuration.

You can deploy up to 255 chassis clusters in a *Layer 2* domain. Clusters and nodes are identified in the following ways:

- The *cluster ID* (a number from 1 to 255) identifies the cluster.
- The *node ID* (a number from 0 to 1) identifies the cluster node.

On SRX Series Firewalls, the cluster ID and node ID are written into EEPROM. On the vSRX Virtual Firewall VM, vSRX Virtual Firewall stores and reads the IDs from **boot/loader.conf** and uses the IDs to initialize the chassis cluster during startup.

Ensure that your vSRX Virtual Firewall instances comply with the following prerequisites before you enable chassis clustering:

- You have committed a basic configuration to both vSRX Virtual Firewall instances that form the chassis cluster. See [Configuring vSRX Using the CLI](#).
- Use `show version` in Junos OS to ensure that both vSRX Virtual Firewall instances have the same software version.
- Use `show system license` in Junos OS to ensure that both vSRX Virtual Firewall instances have the same licenses installed.
- You must set the same chassis cluster ID on each vSRX Virtual Firewall node and reboot the vSRX Virtual Firewall VM to enable chassis cluster formation.

The chassis cluster formation commands for node 0 and node 1 are as follows:

- On vSRX Virtual Firewall node 0:

```
user@vsrx0>set chassis cluster cluster-id number node 0 reboot
```

- On vSRX Virtual Firewall node 1:

```
user@vsrx1>set chassis cluster cluster-id number node 1 reboot
```

The vSRX Virtual Firewall interface naming and mapping to vNICs changes when you enable chassis clustering. Use the same cluster ID number for each node in the cluster.

**NOTE:** When using multiple clusters that are connected to the same L2 domain, a unique cluster-id needs to be used for each cluster. Otherwise you may get duplicate mac addresses on the network, because the cluster-id is used to form the virtual interface mac addresses.

After reboot, on node 0, configure the fabric (data) ports of the cluster that are used to pass real-time objects (RTOs):

- `user@vsrx0# set interfaces fab0 fabric-options member-interfaces ge-0/0/0`  
`user@vsrx0# set interfaces fab1 fabric-options member-interfaces ge-7/0/0`

## Chassis Cluster Quick Setup with J-Web

To configure chassis cluster from *J-Web*:

1. Enter the vSRX Virtual Firewall node 0 interface IP address in a Web browser.
2. Enter the vSRX Virtual Firewall username and password, and click **Log In**. The J-Web dashboard appears.
3. Click **Configuration Wizards>Chassis Cluster** from the left panel. The Chassis Cluster Setup wizard appears. Follow the steps in the setup wizard to configure the cluster ID and the two nodes in the cluster, and to verify connectivity.

**NOTE:** Use the built-in Help icon in J-Web for further details on the Chassis Cluster Setup wizard.

## Manually Configure a Chassis Cluster with J-Web

You can use the *J-Web* interface to configure the primary node 0 vSRX Virtual Firewall instance in the cluster. Once you have set the cluster and node IDs and rebooted each vSRX Virtual Firewall, the following configuration will automatically be synced to the secondary node 1 vSRX Virtual Firewall instance.

Select **Configure>Chassis Cluster>Cluster Configuration**. The Chassis Cluster configuration page appears.

[Table 31 on page 168](#) explains the contents of the HA Cluster Settings tab.

[Table 32 on page 170](#) explains how to edit the Node Settings tab.

[Table 33 on page 171](#) explains how to add or edit the HA Cluster Interfaces table.

[Table 34 on page 172](#) explains how to add or edit the HA Cluster Redundancy Groups table.

### Table 46: Chassis Cluster Configuration Page

| Field                | Function |
|----------------------|----------|
| <b>Node Settings</b> |          |

---

Table 46: Chassis Cluster Configuration Page (Continued)

| Field                | Function                                                                                                                                                                                                   |
|----------------------|------------------------------------------------------------------------------------------------------------------------------------------------------------------------------------------------------------|
| Node ID              | Displays the node ID.                                                                                                                                                                                      |
| Cluster ID           | Displays the cluster ID configured for the node.                                                                                                                                                           |
| Host Name            | Displays the name of the node.                                                                                                                                                                             |
| Backup Router        | Displays the router used as a gateway while the Routing Engine is in secondary state for redundancy-group 0 in a chassis cluster.                                                                          |
| Management Interface | Displays the management interface of the node.                                                                                                                                                             |
| IP Address           | Displays the management IP address of the node.                                                                                                                                                            |
| Status               | <p>Displays the state of the redundancy group.</p> <ul style="list-style-type: none"> <li>• <b>Primary</b>—Redundancy group is active.</li> <li>• <b>Secondary</b>—Redundancy group is passive.</li> </ul> |

**Chassis Cluster>HA Cluster Settings>Interfaces**

|                              |                                                                               |
|------------------------------|-------------------------------------------------------------------------------|
| Name                         | Displays the physical interface name.                                         |
| Member Interfaces/IP Address | Displays the member interface name or IP address configured for an interface. |
| Redundancy Group             | Displays the redundancy group.                                                |

**Chassis Cluster>HA Cluster Settings>Redundancy Group**

|       |                                                      |
|-------|------------------------------------------------------|
| Group | Displays the redundancy group identification number. |
|-------|------------------------------------------------------|

Table 46: Chassis Cluster Configuration Page (*Continued*)

| Field                | Function                                                                                                                                                                                                                                  |
|----------------------|-------------------------------------------------------------------------------------------------------------------------------------------------------------------------------------------------------------------------------------------|
| Preempt              | <p>Displays the selected preempt option.</p> <ul style="list-style-type: none"> <li>• <b>True</b>–Primary Role can be preempted based on priority.</li> <li>• <b>False</b>–Primary Role cannot be preempted based on priority.</li> </ul> |
| Gratuitous ARP Count | <p>Displays the number of gratuitous Address Resolution Protocol (<i>ARP</i>) requests that a newly elected primary device in a chassis cluster sends out to announce its presence to the other network devices.</p>                      |
| Node Priority        | <p>Displays the assigned priority for the redundancy group on that node. The eligible node with the highest priority is elected as primary for the redundant group.</p>                                                                   |

Table 47: Edit Node Setting Configuration Details

| Field                | Function                                                                                                                              | Action                                     |
|----------------------|---------------------------------------------------------------------------------------------------------------------------------------|--------------------------------------------|
| <b>Node Settings</b> |                                                                                                                                       |                                            |
| Host Name            | Specifies the name of the host.                                                                                                       | Enter the name of the host.                |
| Backup Router        | Displays the device used as a gateway while the Routing Engine is in the secondary state for redundancy-group 0 in a chassis cluster. | Enter the IP address of the backup router. |
| <b>Destination</b>   |                                                                                                                                       |                                            |
| IP                   | Adds the destination address.                                                                                                         | Click <b>Add</b> .                         |
| Delete               | Deletes the destination address.                                                                                                      | Click <b>Delete</b> .                      |
| <b>Interface</b>     |                                                                                                                                       |                                            |



Table 47: Edit Node Setting Configuration Details (Continued)

| Field     | Function                                                                                                                               | Action                          |
|-----------|----------------------------------------------------------------------------------------------------------------------------------------|---------------------------------|
| Interface | Specifies the interfaces available for the router.<br><br><b>NOTE:</b> Allows you to add and edit two interfaces for each fabric link. | Select an option.               |
| IP        | Specifies the interface IP address.                                                                                                    | Enter the interface IP address. |
| Add       | Adds the interface.                                                                                                                    | Click <b>Add</b> .              |
| Delete    | Deletes the interface.                                                                                                                 | Click <b>Delete</b> .           |

Table 48: Add HA Cluster Interface Configuration Details

| Field                                        | Function                    | Action                                    |
|----------------------------------------------|-----------------------------|-------------------------------------------|
| <b>Fabric Link &gt; Fabric Link 0 (fab0)</b> |                             |                                           |
| Interface                                    | Specifies fabric link 0.    | Enter the interface IP fabric link 0.     |
| Add                                          | Adds fabric interface 0.    | Click <b>Add</b> .                        |
| Delete                                       | Deletes fabric interface 0. | Click <b>Delete</b> .                     |
| <b>Fabric Link &gt; Fabric Link 1 (fab1)</b> |                             |                                           |
| Interface                                    | Specifies fabric link 1.    | Enter the interface IP for fabric link 1. |
| Add                                          | Adds fabric interface 1.    | Click <b>Add</b> .                        |
| Delete                                       | Deletes fabric interface 1. | Click <b>Delete</b> .                     |
| <b>Redundant Ethernet</b>                    |                             |                                           |

Table 48: Add HA Cluster Interface Configuration Details (Continued)

| Field            | Function                                                                                           | Action                                   |
|------------------|----------------------------------------------------------------------------------------------------|------------------------------------------|
| Interface        | Specifies a logical interface consisting of two physical Ethernet interfaces, one on each chassis. | Enter the logical interface.             |
| IP               | Specifies a redundant Ethernet IP address.                                                         | Enter a redundant Ethernet IP address.   |
| Redundancy Group | Specifies the redundancy group ID number in the chassis cluster.                                   | Select a redundancy group from the list. |
| Add              | Adds a redundant Ethernet IP address.                                                              | Click <b>Add</b> .                       |
| Delete           | Deletes a redundant Ethernet IP address.                                                           | Click <b>Delete</b> .                    |

Table 49: Add Redundancy Groups Configuration Details

| Field                           | Function                                                                                                                                                                                                                                                                                                                                                         | Action                                        |
|---------------------------------|------------------------------------------------------------------------------------------------------------------------------------------------------------------------------------------------------------------------------------------------------------------------------------------------------------------------------------------------------------------|-----------------------------------------------|
| Redundancy Group                | Specifies the redundancy group name.                                                                                                                                                                                                                                                                                                                             | Enter the redundancy group name.              |
| Allow preemption of primaryship | Allows a node with a better priority to initiate a failover for a redundancy group.<br><br><b>NOTE:</b> By default, this feature is disabled. When disabled, a node with a better priority does not initiate a redundancy group failover (unless some other factor, such as faulty network connectivity identified for monitored interfaces, causes a failover). | -                                             |
| Gratuitous ARP Count            | Specifies the number of gratuitous Address Resolution Protocol requests that a newly elected primary sends out on the active redundant Ethernet interface child links to notify network devices of a change in primary role on the redundant Ethernet interface links.                                                                                           | Enter a value from 1 to 16. The default is 4. |

Table 49: Add Redundancy Groups Configuration Details (Continued)

| Field                                 | Function                                                                                        | Action                                                                  |
|---------------------------------------|-------------------------------------------------------------------------------------------------|-------------------------------------------------------------------------|
| node0 priority                        | Specifies the priority value of node0 for a redundancy group.                                   | Enter the node priority number as 0.                                    |
| node1 priority                        | Specifies the priority value of node1 for a redundancy group.                                   | Select the node priority number as 1.                                   |
| <b>Interface Monitor</b>              |                                                                                                 |                                                                         |
| Interface                             | Specifies the number of redundant Ethernet interfaces to be created for the cluster.            | Select an interface from the list.                                      |
| Weight                                | Specifies the weight for the interface to be monitored.                                         | Enter a value from 1 to 125.                                            |
| Add                                   | Adds interfaces to be monitored by the redundancy group along with their respective weights.    | Click <b>Add</b> .                                                      |
| Delete                                | Deletes interfaces to be monitored by the redundancy group along with their respective weights. | Select the interface from the configured list and click <b>Delete</b> . |
| <b>IP Monitoring</b>                  |                                                                                                 |                                                                         |
| Weight                                | Specifies the global weight for IP monitoring.                                                  | Enter a value from 0 to 255.                                            |
| Threshold                             | Specifies the global threshold for IP monitoring.                                               | Enter a value from 0 to 255.                                            |
| Retry Count                           | Specifies the number of retries needed to declare reachability failure.                         | Enter a value from 5 to 15.                                             |
| Retry Interval                        | Specifies the time interval in seconds between retries.                                         | Enter a value from 1 to 30.                                             |
| <b>IPv4 Addresses to Be Monitored</b> |                                                                                                 |                                                                         |

Table 49: Add Redundancy Groups Configuration Details (*Continued*)

| Field                | Function                                                                  | Action                                                          |
|----------------------|---------------------------------------------------------------------------|-----------------------------------------------------------------|
| IP                   | Specifies the IPv4 addresses to be monitored for reachability.            | Enter the IPv4 addresses.                                       |
| Weight               | Specifies the weight for the redundancy group interface to be monitored.  | Enter the weight.                                               |
| Interface            | Specifies the logical interface through which to monitor this IP address. | Enter the logical interface address.                            |
| Secondary IP address | Specifies the source address for monitoring packets on a secondary link.  | Enter the secondary IP address.                                 |
| Add                  | Adds the IPv4 address to be monitored.                                    | Click <b>Add</b> .                                              |
| Delete               | Deletes the IPv4 address to be monitored.                                 | Select the IPv4 address from the list and click <b>Delete</b> . |

**SEE ALSO**

[Chassis Cluster Feature Guide for Security Devices](#)

# 4

PART

## vSRX Virtual Firewall Deployment for Contrail

---

[Overview of vSRX Virtual Firewall Service Chains in Contrail | 245](#)

[Install vSRX Virtual Firewall in Contrail | 267](#)

[vSRX Virtual Firewall VM Management with Contrail | 291](#)

---

# Overview of vSRX Virtual Firewall Service Chains in Contrail

## IN THIS CHAPTER

- Understand vSRX Virtual Firewall with Contrail | 245
- Requirements for vSRX Virtual Firewall on Contrail | 247
- Overview of Service Chains with vSRX Virtual Firewall | 256
- Spawn vSRX Virtual Firewall in a Contrail Service Chain | 259

## Understand vSRX Virtual Firewall with Contrail

### IN THIS SECTION

- vSRX Virtual Firewall on Juniper Networks Contrail | 245
- vSRX Virtual Firewall Scale Up Performance | 246

This section presents an overview of vSRX Virtual Firewall on Contrail

### vSRX Virtual Firewall on Juniper Networks Contrail

Juniper Networks Contrail is an open, standards-based software solution that delivers network *virtualization* and service automation for federated cloud networks. It provides self-service provisioning, improves network troubleshooting and diagnostics, and enables service chaining for dynamic application environments across enterprise virtual private cloud (VPC), managed Infrastructure as a Service (IaaS), and Networks Functions Virtualization (NFV) use cases.

You can use Contrail with open cloud orchestration systems such as OpenStack or CloudStack to instantiate instances of vSRX Virtual Firewall in a virtual environment. Contrail with vSRX Virtual Firewall provides network services such as *firewall*, *NAT*, and load balancing to virtual networks.

**NOTE:** vSRX Virtual Firewall on a *KVM hypervisor* requires you to enable hardware-based virtualization on a host OS that contains an Intel Virtualization Technology (VT) capable processor.

## vSRX Virtual Firewall Scale Up Performance

Table 50 on page 246 shows the vSRX Virtual Firewall scale up performance based on the number of vCPUs and vRAM applied to a vSRX Virtual Firewall VM along with the Junos OS release in which a particular vSRX Virtual Firewall software specification was introduced.

**Table 50: vSRX Virtual Firewall Scale Up Performance**

| vCPUs   | vRAM | NICs                                                                                           | Release Introduced                                       |
|---------|------|------------------------------------------------------------------------------------------------|----------------------------------------------------------|
| 2 vCPUs | 4 GB | <ul style="list-style-type: none"> <li>• Virtio</li> <li>• SR-IOV (Intel X520/X540)</li> </ul> | Junos OS Release 15.1X49-D20                             |
| 5 vCPUs | 8 GB | <ul style="list-style-type: none"> <li>• Virtio</li> <li>• SR-IOV (Intel X520/X540)</li> </ul> | Junos OS Release 15.1X49-D70 and Junos OS Release 17.3R1 |

You can scale the performance and capacity of a vSRX Virtual Firewall instance by increasing the number of vCPUs and the amount of vRAM allocated to the vSRX Virtual Firewall. The multi-core vSRX Virtual Firewall automatically selects the appropriate vCPUs and vRAM values at boot time, as well as the number of Receive Side Scaling (RSS) queues in the NIC. If the vCPU and vRAM settings allocated to a vSRX Virtual Firewall VM do not match what is currently available, the vSRX Virtual Firewall scales down to the closest supported value for the instance. For example, if a vSRX Virtual Firewall VM has 3 vCPUs and 8 GB of vRAM, vSRX Virtual Firewall boots to the smaller vCPU size, which requires a minimum of 2 vCPUs. You can scale up a vSRX Virtual Firewall instance to a higher number of vCPUs and amount of vRAM, but you cannot scale down an existing vSRX Virtual Firewall instance to a smaller setting.

**NOTE:** The number of RSS queues typically matches with the number of data plane vCPUs of a vSRX Virtual Firewall instance. For example, a vSRX Virtual Firewall with 4 data plane vCPUs should have 4 RSS queues.

## RELATED DOCUMENTATION

[Contrail Overview](#)

## Requirements for vSRX Virtual Firewall on Contrail

### IN THIS SECTION

- [Software Requirements | 247](#)
- [Hardware Recommendations | 251](#)
- [Best Practices for Improving vSRX Virtual Firewall Performance | 251](#)
- [Interface Mapping for vSRX Virtual Firewall on Contrail | 253](#)
- [vSRX Virtual Firewall Default Settings on Contrail | 255](#)

## Software Requirements

[Table 51 on page 247](#) lists the system software requirement specifications when deploying vSRX Virtual Firewall on Juniper Networks Contrail. The table outlines the Junos OS release in which a particular software specification for deploying vSRX Virtual Firewall on KVM was introduced. You will need to download a specific Junos OS release to take advantage of certain features.

**Table 51: Specifications for vSRX Virtual Firewall on Juniper Networks Contrail**

| Component          | Specification | Junos OS Release Introduced                              |
|--------------------|---------------|----------------------------------------------------------|
| Hypervisor support | Linux KVM     | Junos OS Release 15.1X49-D20 and Junos OS Release 17.3R1 |



**Table 51: Specifications for vSRX Virtual Firewall on Juniper Networks Contrail (Continued)**

| Component  | Specification                                                                                                                                                                                                                                                                                                                | Junos OS Release Introduced                              |
|------------|------------------------------------------------------------------------------------------------------------------------------------------------------------------------------------------------------------------------------------------------------------------------------------------------------------------------------|----------------------------------------------------------|
| Memory     | 4 GB                                                                                                                                                                                                                                                                                                                         | Junos OS Release 15.1X49-D20 and Junos OS Release 17.3R1 |
|            | 8 GB                                                                                                                                                                                                                                                                                                                         | Junos OS Release 15.1X49-D70 and Junos OS Release 17.3R1 |
| Disk space | 20 GB IDE drive                                                                                                                                                                                                                                                                                                              | Junos OS Release 15.1X49-D20 and Junos OS Release 17.3R1 |
| vCPUs      | 2 vCPUs<br><br><b>NOTE:</b> The Contrail compute node must bare metal since vSRX Virtual Firewall as a VNF does not support nested virtualization.                                                                                                                                                                           | Junos OS Release 15.1X49-D20 and Junos OS Release 17.3R1 |
|            | 5 vCPUs<br><br><b>NOTE:</b> The Contrail compute node must bare metal since vSRX Virtual Firewall as a VNF does not support nested virtualization.                                                                                                                                                                           | Junos OS Release 15.1X49-D70 and Junos OS Release 17.3R1 |
| vNICs      | Up to 16 vNICs <ul style="list-style-type: none"> <li>• Virtio</li> <li>• SR-IOV</li> </ul> <p><b>NOTE:</b> We recommend the Intel X520/X540 physical NICs for SR-IOV support on vSRX Virtual Firewall. For SR-IOV limitations, see the <i>Known Behavior</i> section of the <i>vSRX Virtual Firewall Release Notes</i>.</p> | Junos OS Release 15.1X49-D20 and Junos OS Release 17.3R1 |

Table 52 on page 249 lists the software specifications on the vSRX Virtual Firewall.

**Table 52: Software Specifications for vSRX Virtual Firewall 3.0 on Juniper Networks Contrail**

| Flavor Name        | vCPU                                                                                                                                                                                                                                                                    | Junos OS Release Introduced              |
|--------------------|-------------------------------------------------------------------------------------------------------------------------------------------------------------------------------------------------------------------------------------------------------------------------|------------------------------------------|
| Hypervisor support | Linux KVM                                                                                                                                                                                                                                                               | Junos OS Release 18.2R1 or later release |
| Memory             | 4 GB                                                                                                                                                                                                                                                                    | Junos OS Release 18.2R1 or later release |
|                    | 8 GB                                                                                                                                                                                                                                                                    | Junos OS Release 18.2R1 or later release |
| Disk space         | 20 GB IDE drive                                                                                                                                                                                                                                                         | Junos OS Release 18.2R1 or later release |
| vCPUs              | 2 vCPUs                                                                                                                                                                                                                                                                 | Junos OS Release 18.2R1 or later release |
|                    | 5 vCPUs                                                                                                                                                                                                                                                                 | Junos OS Release 18.2R1 or later release |
| vNICs              | Up to 16 vNICs <ul style="list-style-type: none"> <li>• Virtio</li> <li>• SR-IOV</li> </ul> <p><b>NOTE:</b> We recommend the Intel X520 physical NICs for SR-IOV support on small flavor vSRX Virtual Firewall, Intel X710 for Medium flavor vSRX Virtual Firewall.</p> | Junos OS Release 18.2R1 or later release |

### Contrail Recommendations for vSRX Virtual Firewall

[Table 53 on page 249](#) lists the recommended software versions to run vSRX Virtual Firewall on Contrail.

**Table 53: Contrail Recommendations for vSRX Virtual Firewall**

| Software | Version | Supported Release                                                         |
|----------|---------|---------------------------------------------------------------------------|
| Contrail | 2.20    | Junos OS Release 15.1X49-D20 and Junos OS Release 17.3R1 or later release |

**Table 53: Contrail Recommendations for vSRX Virtual Firewall (Continued)**

| Software     | Version          | Supported Release                                                         |
|--------------|------------------|---------------------------------------------------------------------------|
|              | 3.1              | Junos OS Release 15.1X49-D60 and Junos OS Release 17.3R1 or later release |
|              | 3.5              | Junos OS Release 18.4R1                                                   |
| OpenStack    | Juno or Icehouse | Junos OS Release 15.1X49-D20 and Junos OS Release 17.3R1 or later release |
|              | Juno or Kilo     | Junos OS Release 15.1X49-D60 and Junos OS Release 17.3R1 or later release |
| Host OS      | Ubuntu 14.04.2   | Junos OS Release 15.1X49-D20 and Junos OS Release 17.3R1 or later release |
| Linux Kernel | 3.16             | Junos OS Release 15.1X49-D20 and Junos OS Release 17.3R1 or later release |

**NOTE:** We recommend that you enable hardware-based virtualization on the host machine. You can verify CPU compatibility here: [http://www.linux-kvm.org/page/Processor\\_support](http://www.linux-kvm.org/page/Processor_support). See [Contrail - Server Requirements](#) to review any additional requirements for Contrail.

[Table 54 on page 250](#) lists the contrail recommendations for vSRX Virtual Firewall.

**Table 54: Contrail Recommendations for vSRX Virtual Firewall 3.0**

| Software | Version | Supported Release                        |
|----------|---------|------------------------------------------|
| Contrail | 3.1     | Junos OS Release 18.2R1 or later release |
|          | 3.2     | Junos OS Release 18.2R1 or later release |

**Table 54: Contrail Recommendations for vSRX Virtual Firewall 3.0 (Continued)**

| Software     | Version         | Supported Release                        |
|--------------|-----------------|------------------------------------------|
|              | 5.X             | Junos OS Release 19.3R1 or later release |
| OpenStack    | Centos 7 or 8   | Junos OS Release 18.2R1 or later release |
| Host OS      | Ubuntu 14.04.2  | Junos OS Release 18.2R1 or later release |
| Linux Kernel | Queens or later | Junos OS Release 18.2R1 or later release |

## Hardware Recommendations

Table 55 on page 251 lists the hardware specifications for the host machine that runs the vSRX Virtual Firewall VM.

**Table 55: Hardware Specifications for the Host Machine**

| Component               | Specification                                                                                                                                                                                      |
|-------------------------|----------------------------------------------------------------------------------------------------------------------------------------------------------------------------------------------------|
| Host memory size        | 4 GB (minimum) .                                                                                                                                                                                   |
| Host processor type     | Intel x86_64 multicore CPU<br><br><b>NOTE:</b> DPDK requires Intel Virtualization VT-x/VT-d support in the CPU. See <a href="#">About Intel Virtualization Technology</a> .                        |
| Virtual network adapter | VMXNet3 device or VMWare Virtual NIC<br><br><b>NOTE:</b> Virtual Machine Communication Interface (VMCI) communication channel is internal to the ESXi hypervisor and the vSRX Virtual Firewall VM. |

## Best Practices for Improving vSRX Virtual Firewall Performance

Review the following practices to improve vSRX Virtual Firewall performance.

## NUMA Nodes

The x86 server architecture consists of multiple sockets and multiple cores within a socket. Each socket also has memory that is used to store packets during I/O transfers from the NIC to the host. To efficiently read packets from memory, guest applications and associated peripherals (such as the NIC) should reside within a single socket. A penalty is associated with spanning CPU sockets for memory accesses, which might result in nondeterministic performance. For vSRX Virtual Firewall, we recommend that all vCPUs for the vSRX Virtual Firewall VM are in the same physical non-uniform memory access (NUMA) node for optimal performance.



**CAUTION:** The packet forwarding engine (PFE) on the vSRX Virtual Firewall might become unresponsive if the NUMA nodes topology properties in OpenStack includes the line `hw:numa_nodes=2` to spread the instance's vCPUs across multiple host NUMA nodes. We recommend that you remove the `hw:numa_nodes=2` line from OpenStack to ensure that the PFE functions properly.

## PCI NIC-to-VM Mapping

If the node on which vSRX Virtual Firewall is running is different from the node to which the Intel PCI NIC is connected, then packets will have to traverse an additional hop in the QPI link, and this will reduce overall throughput. On a Linux host OS, install the `hwloc` package and use the `lstopo` command to view information about relative physical NIC locations. On some servers where this information is not available, refer to the hardware documentation for the slot-to-NUMA node topology.

## Mapping Virtual Interfaces to a vSRX Virtual Firewall VM

To determine which virtual interfaces on your Linux host OS map to a vSRX Virtual Firewall VM:

1. Use the `virsh list` command on your Linux host OS to list the running VMs.

```
hostOS# virsh list
```

| Id | Name              | State   |
|----|-------------------|---------|
| 25 | instance-00000060 | running |
| 31 | instance-0000005b | running |
| 34 | instance-000000bd | running |
| 35 | instance-000000bc | running |

2. Use the `virsh domiflist vsrx-name` command to list the virtual interfaces on that vSRX Virtual Firewall VM.

```
hostOS# virsh domiflist 31
```

| Interface      | Type     | Source | Model  | MAC               |
|----------------|----------|--------|--------|-------------------|
| tapd3d9639c-d5 | ethernet | -      | virtio | 02:d3:d9:63:9c:d5 |
| tapc3c3751a-37 | ethernet | -      | virtio | 02:c3:c3:75:1a:37 |
| tap8af29333-1b | ethernet | -      | virtio | 02:8a:f2:93:33:1b |
| tapf0387bee-9b | ethernet | -      | virtio | 02:f0:38:7b:ee:9b |
| tap04e4b59a-91 | ethernet | -      | virtio | 02:04:e4:b5:9a:91 |

**NOTE:** The first virtual interface maps to the `fxp0` interface in Junos OS.

## Interface Mapping for vSRX Virtual Firewall on Contrail

Each network adapter defined for a vSRX Virtual Firewall is mapped to a specific interface, depending on whether the vSRX Virtual Firewall instance is a standalone VM or one of a cluster pair for high availability. The interface names and mappings in vSRX Virtual Firewall are shown in [Table 56 on page 254](#) and [Table 57 on page 254](#).

Note the following:

- In standalone mode:
  - `fxp0` is the out-of-band management interface.
  - `ge-0/0/0` is the first traffic (revenue) interface.
- In cluster mode:
  - `fxp0` is the out-of-band management interface.
  - `em0` is the cluster control link for both nodes.
  - Any of the traffic interfaces can be specified as the fabric links, such as `ge-0/0/0` for `fab0` on node 0 and `ge-7/0/0` for `fab1` on node 1.

[Table 56 on page 254](#) shows the interface names and mappings for a standalone vSRX Virtual Firewall VM.

**Table 56: Interface Names for a Standalone vSRX Virtual Firewall VM**

| Network Adapter | Interface Name in Junos OS for vSRX Virtual Firewall |
|-----------------|------------------------------------------------------|
| 1               | fxp0                                                 |
| 2               | ge-0/0/0                                             |
| 3               | ge-0/0/1                                             |
| 4               | ge-0/0/2                                             |
| 5               | ge-0/0/3                                             |
| 6               | ge-0/0/4                                             |
| 7               | ge-0/0/5                                             |
| 8               | ge-0/0/6                                             |

[Table 57 on page 254](#) shows the interface names and mappings for a pair of vSRX Virtual Firewall VMs in a cluster (node 0 and node 1).

**Table 57: Interface Names for a vSRX Virtual Firewall Cluster Pair**

| Network Adapter | Interface Name in Junos OS for vSRX Virtual Firewall |
|-----------------|------------------------------------------------------|
| 1               | fxp0 (node 0 and 1)                                  |
| 2               | em0 (node 0 and 1)                                   |
| 3               | ge-0/0/0 (node 0)<br>ge-7/0/0 (node 1)               |

**Table 57: Interface Names for a vSRX Virtual Firewall Cluster Pair (Continued)**

| Network Adapter | Interface Name in Junos OS for vSRX Virtual Firewall |
|-----------------|------------------------------------------------------|
| 4               | ge-0/0/1 (node 0)<br>ge-7/0/1 (node 1)               |
| 5               | ge-0/0/2 (node 0)<br>ge-7/0/2 (node 1)               |
| 6               | ge-0/0/3 (node 0)<br>ge-7/0/3 (node 1)               |
| 7               | ge-0/0/4 (node 0)<br>ge-7/0/4 (node 1)               |
| 8               | ge-0/0/5 (node 0)<br>ge-7/0/5 (node 1)               |

### vSRX Virtual Firewall Default Settings on Contrail

vSRX Virtual Firewall requires the following basic configuration settings:

- Interfaces must be assigned IP addresses.
- Interfaces must be bound to zones.
- Policies must be configured between zones to permit or deny traffic.

[Table 58 on page 255](#) lists the factory default settings for the vSRX Virtual Firewall security policies.

**Table 58: Factory Default Settings for Security Policies**

| Source Zone | Destination Zone | Policy Action |
|-------------|------------------|---------------|
| trust       | untrust          | permit        |
| trust       | trust            | permit        |



Table 58: Factory Default Settings for Security Policies (*Continued*)

| Source Zone | Destination Zone | Policy Action |
|-------------|------------------|---------------|
| untrust     | trust            | deny          |

## RELATED DOCUMENTATION

[About Intel Virtualization Technology](#)

[PCI Devices](#)

[DPDK Release Notes](#)

## Overview of Service Chains with vSRX Virtual Firewall

### IN THIS SECTION

- [Understanding Service Chains | 256](#)
- [Service Chain Modes | 257](#)
- [Components of a Service Chain | 257](#)

You can use Contrail to chain various Layer 2 through Layer 7 services such as *firewall*, *NAT*, and *IDP* through one or more vSRX Virtual Firewall VMs. For example, you can insert a vSRX Virtual Firewall firewall VM between two other virtual machines (VMs). By using vSRX Virtual Firewall and service chains, you can tailor the security needs to a targeted virtual network and VM set. This provides agility and scalability in line with the fluidity of cloud network environments.

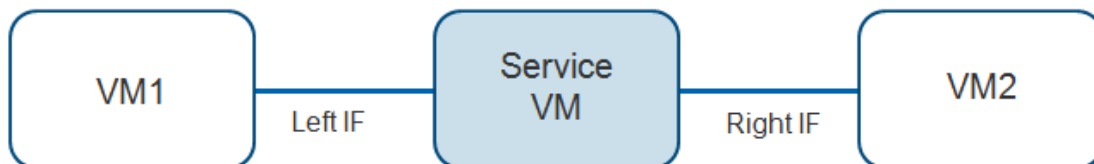
### Understanding Service Chains

To create a service through vSRX Virtual Firewall, you instantiate one or more vSRX Virtual Firewall VMs to dynamically apply single or multiple services to network traffic.

[Figure 50 on page 257](#) shows a basic service chain with a single vSRX Virtual Firewall VM. The vSRX Virtual Firewall service VM spawns a service, such as a firewall. The left interface (left IF) points to the

internal end customer, who uses the service; and the right interface (right IF) points to the external network or Internet. You can also instantiate multiple vSRX Virtual Firewall VMs to chain multiple services together. For example, you could add an IDP service after the firewall.

**Figure 50: vSRX Virtual Firewall Service Chaining**



When you create a service chain, Contrail creates tunnels across the underlay network that span all services in the chain.

## Service Chain Modes

You can configure the following service modes:

- Transparent or bridge mode—Used for services that do not modify the packet. Also known as bump-in-the-wire or Layer 2 mode. Examples include Layer 2 firewall and IDP.
- In-network or routed mode—Provides a gateway service that routes packets between the service instance interfaces. Examples include NAT, Layer 3 firewall, and load balancing.
- In-network-nat mode—Similar to in-network mode; however, packets from the left (private) network are not routed to the right (public) source network. In-network-nat mode is particularly useful for NAT services.

**NOTE:** Ensure that you define the service policy with the private network on the left and public on the right in order to get the public routes (usually the default) advertised into the left network.

## Components of a Service Chain

Service chaining requires the following configuration components to build the chain:

- Service template
- Virtual networks
- Service instance
- Network policy

## Service Templates

Service templates map out the basic configuration that Contrail uses to instantiate a service instance, or VM. Within Contrail, you configure service templates in the scope of a domain, and you can use the templates on all projects within a domain. You can use a template to launch multiple service instances of the same type in different projects within a domain. Within a service template, you select the service mode, a vSRX Virtual Firewall image name for the VM that will provide the service, and an ordered list of interfaces for the service. vSRX Virtual Firewall service VMs require the management interface to be the first interface in that ordered list. You can use OpenStack Horizon or Glance to add the vSRX Virtual Firewall image. You also select the OpenStack flavor to associate with all service instances that use the service template. An OpenStack flavor defines the number of vCPUs, storage, and memory you can assign to a VM. OpenStack includes default flavors, and you can create new flavors in the OpenStack dashboard.

## Virtual Networks

Virtual networks provide the link between the service instance and the network traffic in the virtualized environment. You can create the virtual networks in Contrail or OpenStack and use those networks to direct traffic to or through the service instance.

## Service Instances

A service instance is the instantiation of the selected service template to create one or more VMs that provide the service (for example, a firewall). When you create a service instance, you select a service template that defines the instance. You also associate the interfaces in the service template with the virtual networks needed to direct traffic into and out of the service instance. If you enable service scaling in the selected service template, you can instantiate more than one VM when you create the service instance.

## Network Policies

By default, all traffic in a virtual network remains isolated. You configure a network policy to allow traffic between virtual networks and through the service instance. The network policy filters traffic to and from the service VM based on the rules you configure. You select the service instance VM and the virtual

networks for the right and left interfaces of that VM that the network policy applies to. As a final step, you associate the network policy with each virtual network the policy applies to.

## RELATED DOCUMENTATION

| [Contrail - Service Chaining](#)

## Spawn vSRX Virtual Firewall in a Contrail Service Chain

### IN THIS SECTION

- [Create a Service Template | 259](#)
- [Create Left and Right Virtual Networks | 262](#)
- [Create a vSRX Virtual Firewall Service Instance | 263](#)
- [Create a Network Policy | 263](#)
- [Add a Network Policy to a Virtual Network | 264](#)

Ensure that you have installed Contrail and have loaded the vSRX Virtual Firewall images with OpenStack Horizon or Glance.

- [Installation Overview \(Contrail\)](#)
- [Add the Image Service \(glance\)](#)

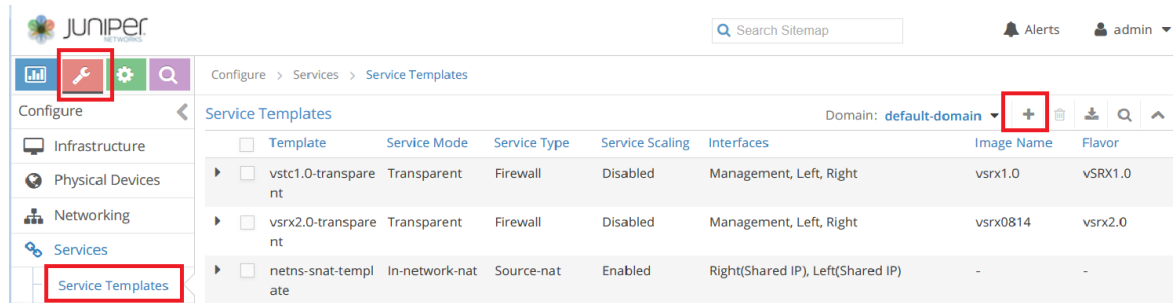
You can use Contrail to chain various Layer 2 through Layer 7 services such as firewall, NAT, and IDP through vSRX Virtual Firewall VMs.

### Create a Service Template

To create a service template:

1. From Contrail, select **Configure>Services>Service Templates**. The list of existing service templates appears, as shown in [Figure 51 on page 260](#).

Figure 51: Contrail Service Templates



- 2. Click + to create a new service template. The Add Service Template dialog box appears, as shown in Figure 52 on page 260.

Figure 52: Contrail Add a Service Template

### Add Service Template

Name:

Service Mode:  Service Type:

Image Name:

| Interface Types                         | Shared IP                | Static Routes            |     |
|-----------------------------------------|--------------------------|--------------------------|-----|
| <input type="text" value="Management"/> | <input type="checkbox"/> | <input type="checkbox"/> | + - |
| <input type="text" value="Left"/>       | <input type="checkbox"/> | <input type="checkbox"/> | + - |
| <input type="text" value="Right"/>      | <input type="checkbox"/> | <input type="checkbox"/> | + - |

Advanced options

Service Scaling

3. Add a name for the service template in the Name box.
4. Select the appropriate service mode and service type from the lists.
5. Select the vSRX Virtual Firewall image from the Image Name list. This is the image you installed previously in the OpenStack image service.
6. Click + to add three interfaces.
7. Select **Management** for the first interface type, **Left** for the second interface type, and **Right** for the third interface type. You associate the left and right interfaces with the left and right virtual networks when you create the service instance. Any additional interfaces must be of type Other.
8. Expand **Advanced Options** and select an instance flavor from the Instance Flavor list, as shown in [Figure 53 on page 261](#). You can use an appropriate default flavor from OpenStack or a custom flavor you created previously for vSRX Virtual Firewall.

**Figure 53: Advanced Options - Add Service Template**

Add Service Template
✕

---

Image Name

vsrx2 ▾

| Interface Types | Shared IP                | Static Routes            | +   |
|-----------------|--------------------------|--------------------------|-----|
| Management ▾    | <input type="checkbox"/> | <input type="checkbox"/> | + - |
| Left ▾          | <input type="checkbox"/> | <input type="checkbox"/> | + - |
| Right ▾         | <input type="checkbox"/> | <input type="checkbox"/> | + - |

▾ Advanced options

---

Service Scaling

Availability Zone

Instance Flavor

vsrx2.0(RAM:4096 ,CPU cores:2 ,Disk:16 ,S... ▾

Cancel

Save

9. Optionally, check **Scaling** to create multiple identical vSRX Virtual Firewall instances from this service template for load balancing.
10. Click **Save** to create this new service template.

See [Contrail - Creating an In-Network or In-Network-NAT Service Chain](#) for more details.

## Create Left and Right Virtual Networks

Ensure that you have IP Address Management (IPAM) set up for your project.

To create a virtual network:

1. From Contrail, select **Configure>Networking>Networks**. The list of existing networks appears.
2. Verify that your project is displayed as active in the upper right Project list, and click **+** to create a new virtual network. The Create Network dialog box appears, as shown in [Figure 54 on page 262](#)

**Figure 54: Creating a Virtual Network in Contrail**

The screenshot shows the 'Create Network' dialog box with the following configuration:

- Name:** ixLeft
- Network Policy(s):** Select Policies...
- Subnets:**

| IPAM                              | CIDR          | Allocation Pools      | Gateway                                        | DNS                                 | DHCP                                |     |
|-----------------------------------|---------------|-----------------------|------------------------------------------------|-------------------------------------|-------------------------------------|-----|
| default-network-ipam (default...) | 10.250.7.0/24 | <start ip> - <end-ip> | <input checked="" type="checkbox"/> 10.250.7.1 | <input checked="" type="checkbox"/> | <input checked="" type="checkbox"/> | + - |
- Host Routes:** (Collapsed)
- Advanced Options:**
  - Admin State:** Up
  - Shared
  - External

Buttons: Cancel, Save

3. Enter a name for the left virtual network.  
Do not select a network policy yet. You create the network policy after you create the service instance and then you update this virtual network to add the policy.
4. Expand **Subnet** and click **+** to add IPAM to this virtual network.
5. Select the appropriate IPAM from the list.
6. Set the CIDR and Gateway fields.
7. Expand **Advanced Options** and select appropriate options for your network.
8. Click **Save**. The new virtual network appears in the list of configured networks.

9. Repeat this procedure for the right virtual network.

See [Contrail - Creating a Virtual Network](#) for more details

## Create a vSRX Virtual Firewall Service Instance

To create a vSRX Virtual Firewall service instance:

1. Select **Configure>Services>Service Instances**. The list of existing service instances appears.
2. Click **+** to create a new service instance. The Create Service Instance dialog box appears.
3. Enter a name for the service instance.

**NOTE:** Do not use white space in the service instance name.

4. Select the service template you created for vSRX Virtual Firewall from the Services Template list. This service template includes the vSRX Virtual Firewall image used to provide the service.
5. Select **Management** from the Interface 1 list. Management must be the first interface for vSRX Virtual Firewall service instances.
6. Select **Left** from the Interface 2 list, and **Right** from the Interface 3 list.
7. Select **Auto Configured** for the Management interface.
8. Select the left virtual network for the left interface, and the right virtual network for the right interface.
9. Click **Save** to save this service instance. Contrail launches the vSRX Virtual Firewall VM for this service instance.
10. Optionally, select **Configure>Services>Service Instances** to view this new vSRX Virtual Firewall instance status. You can expand the row for this instance in the table and click **View Console** to access the vSRX Virtual Firewall console port.

**NOTE:** You can also view this service instance from the OpenStack Instances table, but you should only use Contrail to delete service instances.

See [Contrail - Creating an In-Network or In-Network-NAT Service Chain](#) for more details.

## Create a Network Policy

To create a network policy:

1. Select **Configure>Networking>Policies**. The table of policies appears.
2. Click **+** to create a new policy. The Create Policy dialog box appears, as shown in [Figure 55 on page 264](#).



**Figure 55: Creating a Network Policy in Contrail**

The screenshot shows the 'Create Policy' window in Contrail. The 'Name' field contains 'vSRXPolicy1'. Under 'Policy Rules', there is a table with the following data:

| Action | Protocol | Source | Ports | Direction | Destination | Ports | Services                            | Mirror                   |     |
|--------|----------|--------|-------|-----------|-------------|-------|-------------------------------------|--------------------------|-----|
| PASS   | ANY      | ixLeft | ANY   | <>        | ixRight     | ANY   | <input checked="" type="checkbox"/> | <input type="checkbox"/> | - + |

Below the table, the 'Services' dropdown is set to 'ixSvcTest'. At the bottom right, there are 'Cancel' and 'Save' buttons.

3. Name the policy.
4. Click **+** to create a new rule for this policy.
5. Select the left virtual network you created from the Source list and select the right virtual network from the Destination list.
6. Select the appropriate protocol from the Protocol list and select the source and destination ports for this policy.
7. Select **Services** and select the vSRX Virtual Firewall instance you want to apply this policy to.
8. Optionally, add more policy rules to this policy.
9. Click **Save** to create this policy.

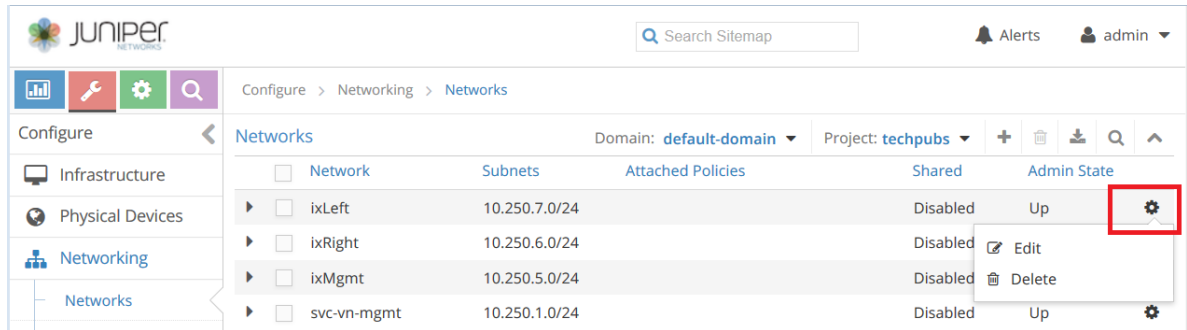
See [Contrail - Creating a Network Policy](#) for more details.

## Add a Network Policy to a Virtual Network

To add a network policy to a virtual network:

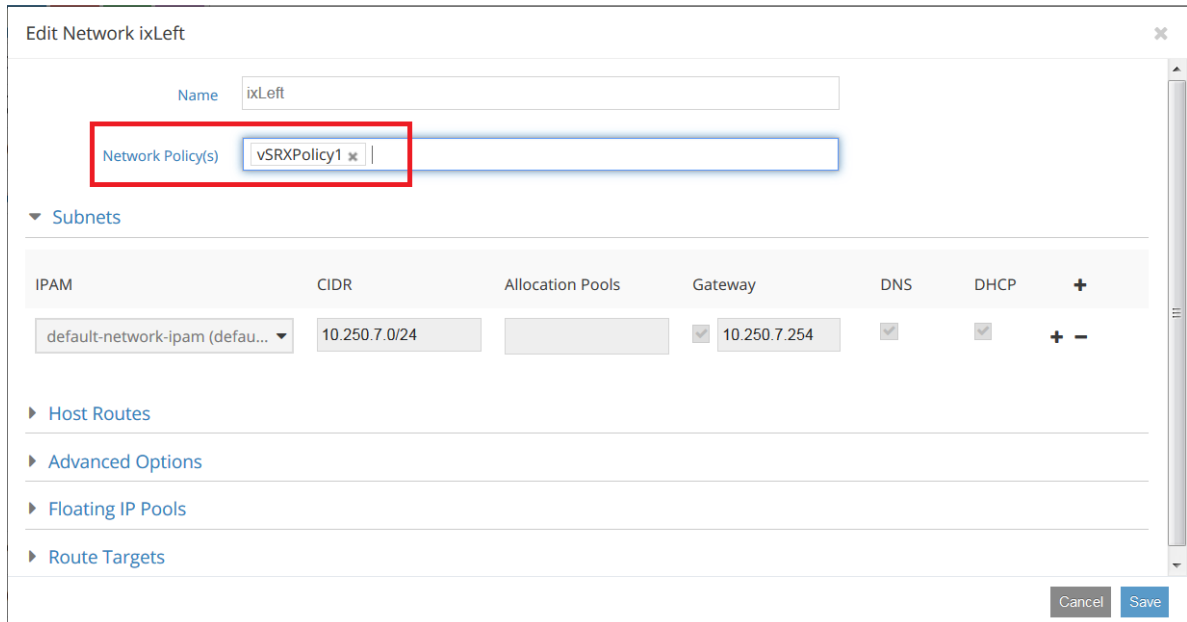
1. Select **Configure>Networking**, and select the settings icon to the right of the virtual network you want to add a network policy to, as shown in [Figure 56 on page 265](#).

Figure 56: Contrail Virtual Networks



2. Click **Edit**. The Edit Networks dialog box appears, as shown in [Figure 57 on page 265](#).

Figure 57: Adding a Network Policy to a Virtual Network in Contrail



3. Select the appropriate policy from the Networks Policy(s) list.
4. Click **Save** to save this change.
5. Repeat this procedure for the other virtual network in this service chain.

See [Contrail - Associating a Network to a Policy](#) for more details.

## RELATED DOCUMENTATION

[Contrail - Creating an In-Network or In-Network-NAT Service Chain](#)

| [Conrail - Installation Overview](#)

# Install vSRX Virtual Firewall in Contrail

## IN THIS CHAPTER

- Enable Nested Virtualization | 267
- Create an Image Flavor with OpenStack | 269
- Upload the vSRX Virtual Firewall Image | 273
- Use Cloud-Init in an OpenStack Environment to Automate the Initialization of vSRX Virtual Firewall Instances | 277

## Enable Nested Virtualization

We recommend that you enable nested *virtualization* on your host OS or OpenStack compute node. Nested virtualization is enabled by default on Ubuntu but is disabled by default on *CentOS*.

Use the following command to determine if nested virtualization is enabled on your host OS. The result should be Y.

```
hostOS# cat /sys/module/kvm_intel/parameters/nested
```

```
hostOS# Y
```

**NOTE:** APIC virtualization (APICv) does not work well with nested VMs such as those used with KVM. On Intel CPUs that support APICv (typically v2 models, for example E5 v2 and E7 v2), you must disable APICv on the host server before deploying vSRX Virtual Firewall.

To enable nested virtualization on the host OS:

1. Depending on your host operating system, perform the following:
  - On CentOS, open the `/etc/modprobe.d/dist.conf` file in your default editor.

```
hostOS# vi /etc/modprobe.d/dist.conf
```

- On Ubuntu, open the `/etc/modprobe.d/qemu-system-x86.conf` file in your default editor.

```
hostOS# vi /etc/modprobe.d/qemu-system-x86.conf
```

2. Add the following line to the file:

```
hostOS# options kvm-intel nested=y enable_apicv=n
```

3. Save the file and reboot the host OS.
4. (Optional) After the reboot, verify that nested virtualization is enabled.

```
hostOS# cat /sys/module/kvm_intel/parameters/nested
```

```
hostOS# Y
```

5. On Intel CPUs that support APICv ( for example, E5 v2 and E7 v2), disable APICv on the host OS.

```
root@host# sudo rmmmod kvm-intel  
root@host# sudo sh -c "echo 'options kvm-intel enable_apicv=n' >> /etc/modprobe.d/dist.conf"  
root@host# sudo modprobe kvm-intel
```

6. Optionally, verify that APICv is now disabled.

```
root@host# cat /sys/module/kvm_intel/parameters/enable_apicv
```

```
N
```

## Create an Image Flavor with OpenStack

### IN THIS SECTION

- [Create an Image Flavor for vSRX Virtual Firewall with Horizon | 269](#)
- [Create an Image Flavor for vSRX Virtual Firewall with the Nova CLI | 272](#)

Before you begin, ensure that you have a working OpenStack installation. See the [OpenStack Installation Guide](#) for more details.

OpenStack launches instances of images, based on the image installed and VM templates called *flavors*. Flavors set the memory, vCPU, and storage requirements for the vSRX Virtual Firewall image. You can use the Horizon GUI or the OpenStack `nova` commands to create flavors for the vSRX Virtual Firewall VMs. See *Requirements for vSRX on Contrail* for the software requirement specifications for a vSRX Virtual Firewall VM.



**CAUTION:** The packet forwarding engine (PFE) on the vSRX Virtual Firewall might become unresponsive if the NUMA nodes topology properties in OpenStack includes the line `hw:numa_nodes=2` to spread the instance's vCPUs across multiple host NUMA nodes. We recommend that you remove the `hw:numa_nodes=2` line from OpenStack to ensure that the PFE functions properly.

### Create an Image Flavor for vSRX Virtual Firewall with Horizon

OpenStack uses VM templates, or flavors, to set the memory, vCPU, and storage requirements for an image. OpenStack includes a default set of flavors, but we recommend that you create a flavor to match the vSRX Virtual Firewall image requirements.

To create an image flavor for vSRX Virtual Firewall with Horizon:

1. From the Horizon GUI, select your project, and select **Admin>System Panel>Flavors**. The list of existing image flavors appears, as shown in [Figure 58 on page 270](#).

Figure 58: OpenStack Flavors

The screenshot shows the OpenStack Dashboard interface. The top navigation bar includes the Ubuntu logo, 'OpenStack Dashboard', a user profile for 'admin', and a 'Sign Out' button. A left sidebar contains a navigation menu with categories: Project, Admin, System, Overview, Hypervisors, Host Aggregates, Instances, Volumes, Flavors (highlighted), and Images. The main content area is titled 'Flavors' and features a search filter, a '+ Create Flavor' button, and a 'Delete Flavors' button. Below these is a table listing four flavors.

| <input type="checkbox"/> | Flavor Name | VCPUs | RAM    | Root Disk | Ephemeral Disk | Swap Disk | ID                                   | Public | Metadata | Actions     |
|--------------------------|-------------|-------|--------|-----------|----------------|-----------|--------------------------------------|--------|----------|-------------|
| <input type="checkbox"/> | m1.tiny     | 1     | 512MB  | 1GB       | 0GB            | 0MB       | 1                                    | Yes    | No       | Edit Flavor |
| <input type="checkbox"/> | m1.small    | 1     | 2048MB | 20GB      | 0GB            | 0MB       | 2                                    | Yes    | No       | Edit Flavor |
| <input type="checkbox"/> | vSRX1.0     | 2     | 2048MB | 2GB       | 0GB            | 0MB       | c3f24e6f-25df-4014-bfd8-5d42b56adbab | Yes    | No       | Edit Flavor |
| <input type="checkbox"/> | vsrxff2     | 2     | 4096MB | 20GB      | 0GB            | 0MB       | ede2ecd6-99d2-4a19-870a-49298e2726ac | Yes    | No       | Edit Flavor |

2. Click **Create Flavor**. The Create Flavor dialog box appears, as shown in [Figure 59 on page 271](#).

Figure 59: Create a Flavor

**Create Flavor**

Flavor Information \* Flavor Access

**Name \***  
vSRX2.0

**ID ⓘ**  
auto

**VCPUs \***  
2

**RAM (MB) \***  
4096

**Root Disk (GB) \***  
20

**Ephemeral Disk (GB) \***  
0

**Swap Disk (MB) \***  
0

Flavors define the sizes for RAM, disk, number of cores, and other resources and can be selected when users deploy instances.

Cancel Create Flavor

3. Enter a name in the Name box for this vSRX Virtual Firewall flavor.
4. Enter the appropriate value in the vCPUs box for your configuration. The minimum required for vSRX Virtual Firewall is 2 vCPUs.
5. Enter the appropriate value in the RAM MB box. The minimum required for vSRX Virtual Firewall is 4096 MB.
6. Enter the appropriate value in the Root Disk GB box. The minimum required for vSRX Virtual Firewall is 20 GB.
7. Enter the appropriate values in the Ephemeral Disk GB and Swap Disk MB boxes. The minimum required for vSRX Virtual Firewall is 0 for each.
8. Click **Create Flavor**. The flavor appears on the Flavors tab.



## Create an Image Flavor for vSRX Virtual Firewall with the Nova CLI

To create an image flavor for vSRX Virtual Firewall with the nova CLI command:

1. Use the `nova flavor-create` command on the OpenStack compute node that will host the vSRX Virtual Firewall VM. See [Table 59 on page 272](#) for a list of mandatory parameters.

**NOTE:** See the official OpenStack documentation for a complete description of available options for the `nova flavor-create` command.

**Table 59: nova flavor-create Command**

| Command Option                | Description                                                     |
|-------------------------------|-----------------------------------------------------------------|
| <code>--is-public true</code> | Set the flavor as publicly available.                           |
| <i>flavor_name</i>            | Name the vSRX Virtual Firewall flavor.                          |
| <code>auto</code>             | Select <code>auto</code> to automatically assign the flavor ID. |
| <i>ram_megabytes</i>          | Allocate RAM for the VM, in megabytes.                          |
| <i>disk_gigabytes</i>         | Specify disk storage size for the VM.                           |
| <i>vcpus</i>                  | Allocate the number of vCPUs for the vSRX Virtual Firewall VM.  |

**NOTE:** Use `nova help flavor-create` for more details on the command options.

2. Optionally, use the `nova flavor-list` to verify the flavors.

The following example creates a vSRX Virtual Firewall flavor with 4096 MB RAM, 2 vCPUs, and disk storage up to 20 GB:

```
$ nova flavor-create --is-public true vsrx_flavor auto 4096 20 2
```

## RELATED DOCUMENTATION

[OpenStack Installation Guide](#)

[OpenStack End User Guide](#)

## Upload the vSRX Virtual Firewall Image

### IN THIS SECTION

- [Upload the vSRX Virtual Firewall Image with OpenStack Horizon | 273](#)
- [Upload the vSRX Virtual Firewall Image with the OpenStack Glance CLI | 276](#)

Contrail integrates with OpenStack for public, private, or hybrid cloud orchestration. You can install the vSRX Virtual Firewall image and use this installed image to provide security services in a service chain with Contrail.

Before installing vSRX Virtual Firewall, ensure that you have installed either Contrail and, optionally, OpenStack Glance.

- [Contrail - Installation Overview](#)
- [OpenStack - Add the Image Service \(glance\)](#)

You can upload the vSRX Virtual Firewall image with either Horizon, the OpenStack GUI dashboard, or Glance, the OpenStack CLI-based image services project.

**NOTE:** To upgrade an existing vSRX Virtual Firewall instance, see *Migration, Upgrade, and Downgrade* in the *vSRX Virtual Firewall Release Notes*.

### Upload the vSRX Virtual Firewall Image with OpenStack Horizon

To upload a vSRX Virtual Firewall image with Horizon:

1. From the Horizon GUI, select your project, and select **Compute>Images**. The list of existing images appears, as shown in [Figure 60 on page 274](#).

Figure 60: OpenStack Images

The screenshot shows the OpenStack Images dashboard. The top navigation bar includes the Ubuntu logo, 'OpenStack Dashboard', a 'demo' dropdown, and a user profile for 'admin' with a 'Sign Out' link. A left sidebar contains navigation options: Project, Admin, System, Overview, Hypervisors, Host Aggregates, Instances, Volumes, Flavors, and Images. The main content area is titled 'Images' and features a search bar with 'Image Name =' and a 'Filter' button. Below the search bar are three buttons: '+ Create Image' and '\* Delete Images'. A table lists five images with the following data:

| <input type="checkbox"/> | Image Name     | Type     | Status | Public | Protected | Format | Size     | Actions |
|--------------------------|----------------|----------|--------|--------|-----------|--------|----------|---------|
| <input type="checkbox"/> | vsrx0831.0     | Image    | Active | No     | No        | QCOW2  | 2.7 GB   | Edit    |
| <input type="checkbox"/> | vsrx0908.1     | Image    | Active | No     | No        | QCOW2  | 2.7 GB   | Edit    |
| <input type="checkbox"/> | snapshot-vsrx2 | Snapshot | Active | Yes    | No        | QCOW2  | 3.3 GB   | Edit    |
| <input type="checkbox"/> | vsrx1          | Image    | Active | Yes    | No        | RAW    | 263.6 MB | Edit    |
| <input type="checkbox"/> | vsrx2          | Image    | Active | Yes    | No        | QCOW2  | 2.7 GB   | Edit    |

At the bottom of the table, it says 'Displaying 5 items'.

2. Click **Create Image**. The Create Image dialog box appears, as shown in [Figure 61 on page 275](#).

Figure 61: Create an Image

**Create An Image**

**Name** \*

vSRX2.0

**Description**

**Description:**  
Currently only images available via an HTTP URL are supported. The image location must be accessible to the Image Service. Compressed image binaries are supported (.zip and .tar.gz.)  
**Please note:** The Image Location field MUST be a valid and direct URL to the image binary. URLs that redirect or serve error pages will result in unusable images.

**Image Source**

Image File

**Image File** ?

Choose File media-srx-ff...-D15.4.qcow2

**Format** \*

QCOW2 - QEMU Emulator

**Architecture**

**Minimum Disk (GB)** ?

20

**Minimum RAM (MB)** ?

4096

Public

Protected

Cancel Create Image

3. Enter a name for the vSRX Virtual Firewall image, and enter the image location.
4. Select **QCOW2- QEMU Emulator** from the Format list.
5. Enter the appropriate value in the Minimum Disk (GB) box for your configuration. The minimum required for vSRX Virtual Firewall is 20 GB.
6. Enter the appropriate value in the Minimum RAM (MB) box. The minimum required for vSRX Virtual Firewall is 4096 MB.

7. Select **Public**.
8. Click **Create Image**. OpenStack uploads the image to the image service. The image appears on the Images tab.

**NOTE:** The default vSRX Virtual Firewall VM login ID is root with no password. By default, vSRX Virtual Firewall is assigned a DHCP-based IP address if a DHCP server is available on the network.

## Upload the vSRX Virtual Firewall Image with the OpenStack Glance CLI

To upload a vSRX Virtual Firewall image with the Glance CLI:

1. Log in to the appropriate OpenStack compute node.
2. Use `wget` to download the vSRX Virtual Firewall image to the compute node.
3. Use `glance image-create` to add the image to the image service with a base configuration for disk, format, and memory requirements. Use `glance help image-create` for complete details on this command-line tool.

For example, the following command adds the vSRX Virtual Firewall QCOW2 image to the image service with 20 GB disk space and 4096 MB of RAM:

```
glance image-create --name='vSRXimage' --is-public=true --container-format=bare --disk-format=qcow2 --min-disk=20 --min-ram=4096 --file=media-srx-ffp-vsrx-vm-disk-15.1X49-D120.qcow2
```

**NOTE:** vSRX Virtual Firewall requires at least 20 GB of disk space and 4096 MB of RAM.

**NOTE:** The default vSRX Virtual Firewall VM login ID is root with no password. By default, vSRX Virtual Firewall is assigned a DHCP-based IP address if a DHCP server is available on the network.

## RELATED DOCUMENTATION

[Contrail - Installation Overview](#)

[OpenStack Installation Guide for Ubuntu 14.04](#)

[OpenStack - Add the Image Service \(glance\)](#)

[OpenStack - Upload and Manage Images](#)

## Use Cloud-Init in an OpenStack Environment to Automate the Initialization of vSRX Virtual Firewall Instances

### IN THIS SECTION

- [Perform Automatic Setup of a vSRX Virtual Firewall Instance Using an OpenStack Command-Line Interface | 280](#)
- [Perform Automatic Setup of a vSRX Virtual Firewall Instance from the OpenStack Dashboard \(Horizon\) | 282](#)

Starting in Junos OS Release 15.1X49-D100 and Junos OS Release 17.4R1, the cloud-init package (version 0.7x) comes pre-installed in the vSRX Virtual Firewall image to help simplify configuring new vSRX Virtual Firewall instances operating in an OpenStack environment according to a specified user-data file. Cloud-init is performed during the first-time boot of a vSRX Virtual Firewall instance.

Cloud-init is an OpenStack software package for automating the initialization of a cloud instance at boot-up. It is available in Ubuntu and most major Linux and FreeBSD operating systems. Cloud-init is designed to support multiple different cloud providers so that the same virtual machine (VM) image can be directly used in multiple hypervisors and cloud instances without any modification. Cloud-init support in a VM instance runs at boot time (first-time boot) and initializes the VM instance according to the specified user-data file.

A user-data file is a special key in the metadata service that contains a file that cloud-aware applications in the VM instance can access upon a first-time boot. In this case, it is the validated Junos OS configuration file that you intend to upload to a vSRX Virtual Firewall instance as the active configuration. This file uses the standard Junos OS command syntax to define configuration details, such as root password, management IP address, default gateway, and other configuration statements.

When you create a vSRX Virtual Firewall instance, you can use cloud-init with a validated Junos OS configuration file (**juniper.conf**) to automate the initialization of new vSRX Virtual Firewall instances. The user-data file uses the standard Junos OS syntax to define all the configuration details for your vSRX Virtual Firewall instance. The default Junos OS configuration is replaced during the vSRX Virtual Firewall instance launch with a validated Junos OS configuration that you supply in the form of a user-data file.

**NOTE:** If using a release *earlier* than Junos OS Release 15.1X49-D130 and Junos OS Release 18.4R1, the user-data configuration file cannot exceed 16 KB. If your user-data file exceeds this limit, you must compress the file using gzip and use the compressed file. For example, the `gzip junos.conf` command results in the `junos.conf.gz` file.

Starting in Junos OS Release 15.1X49-D130 and Junos OS Release 18.4R1, if using a configuration drive data source in an OpenStack environment, the user-data configuration file size can be up to 64 MB.

The configuration must be validated and include details for the `fxp0` interface, login, and authentication. It must also have a default route for traffic on `fxp0`. If any of this information is missing or incorrect, the instance is inaccessible and you must launch a new one.



**WARNING:** Ensure that the user-data configuration file is not configured to perform autoinstallation on interfaces using Dynamic Host Configuration Protocol (DHCP) to assign an IP address to the vSRX Virtual Firewall. Autoinstallation with DHCP will result in a "commit fail" for the user-data configuration file.

Starting in Junos OS Release 15.1X49-D130 and Junos OS Release 18.4R1, the cloud-init functionality in vSRX Virtual Firewall has been extended to support the use of a configuration drive data source in an OpenStack environment. The configuration drive uses the user-data attribute to pass a validated Junos OS configuration file to the vSRX Virtual Firewall instance. The user-data can be plain text or MIME file type `text/plain`. The configuration drive is typically used in conjunction with the Compute service, and is present to the instance as a disk partition labeled `config-2`. The configuration drive has a maximum size of 64 MB, and must be formatted with either the `vfat` or `ISO 9660` filesystem.

The configuration drive data source also provides the flexibility to add more than one file that can be used for configuration. A typical use case would be to add a Day0 configuration file and a license file. In this case, there are two methods that can be employed to use a configuration drive data source with a vSRX Virtual Firewall instance:

- User-data (Junos OS Configuration File) alone—This approach uses the user-data attribute to pass the Junos OS configuration file to each vSRX Virtual Firewall instance. The user-data can be plain text or MIME file type `text/plain`.
- Junos OS configuration file and license file—This approach uses the configuration drive data source to send the Junos OS configuration and license file(s) to each vSRX Virtual Firewall instance.

**NOTE:** If a license file is to be configured in vSRX Virtual Firewall, it is recommended to use the `-file` option rather than the `user-data` option to provide the flexibility to configure files larger than the 16 KB limit of `user-data`.

To use a configuration drive data source to send Junos OS configuration and license file(s) to a vSRX Virtual Firewall instance, the files need to be sent in a specific folder structure. In this application, the folder structure of the configuration drive data source in vSRX Virtual Firewall is as follows:

```
- OpenStack
  - latest
    - junos-config
      - configuration.txt
    - junos-license
      - License_file_name.lic
      - License_file_name.lic
```

```
//OpenStack//latest/junos-config/configuration.txt
```

```
//OpenStack//latest/junos-license/license.lic
```

Before you begin:

- Create a configuration file with the Junos OS command syntax and save it. The configuration file can be plain text or MIME file type `text/plain`. The string `#junos-config` must be the first line of the user-data configuration file before the Junos OS configuration.

**NOTE:** The `#junos-config` string is mandatory in the user-data configuration file; if it is not included, the configuration will not be applied to the vSRX Virtual Firewall instance as the active configuration.

- Determine the name for the vSRX Virtual Firewall instance you want to initialize with a validated Junos OS configuration file.
- Determine the flavor for your vSRX Virtual Firewall instance, which defines the compute, memory, and storage capacity of the vSRX Virtual Firewall instance.
- Starting in Junos OS Release 15.1X49-D130 and Junos OS Release 18.4R1, if using a configuration drive, ensure the following criteria is met to enable cloud-init support for a configuration drive in OpenStack:
  - The configuration drive must be formatted with either the `vfat` or `iso9660` filesystem.



**NOTE:** The default format of a configuration drive is an ISO 9660 file system. To explicitly specify the ISO 9660/vfat format, add the `config_drive_format=iso9660/vfat` line to the `nova.conf` file.

- The configuration drive must have a filesystem label of `config-2`.
- The folder size must be no greater than 64 MB.

Depending on your OpenStack environment, you can use either an OpenStack command-line interface (such as `nova boot` or `openstack server create`) or the OpenStack Dashboard (“Horizon”) to launch and initialize a vSRX Virtual Firewall instance.

## Perform Automatic Setup of a vSRX Virtual Firewall Instance Using an OpenStack Command-Line Interface

You can launch and manage a vSRX Virtual Firewall instance using either the `nova boot` or `openstack server create` commands, which includes the use of a validated Junos OS configuration user-data file from your local directory to initialize the active configuration of the target vSRX Virtual Firewall instance.

To initiate the automatic setup of a vSRX Virtual Firewall instance from an OpenStack command-line client:

1. If you have not done so already, create a configuration file with the Junos OS command syntax and save the file. The configuration file can be plain text or MIME file type `text/plain`.

The user-data configuration file must contain the full vSRX Virtual Firewall configuration that is to be used as the active configuration on each vSRX Virtual Firewall instance, and the string `#junos-config` must be the first line of the user-data configuration file before the Junos OS configuration.

**NOTE:** The `#junos-config` string is mandatory in the user-data configuration file; if it is not included, the configuration will not be applied to the vSRX Virtual Firewall instance as the active configuration.

2. Copy the Junos OS configuration file to an accessible location from where it can be retrieved to launch the vSRX Virtual Firewall instance.
3. Depending on your OpenStack environment, use the `nova boot` or `openstack server create` command to launch the vSRX Virtual Firewall instance with a validated Junos OS configuration file as the specified user-data.

**NOTE:** You can also use the `nova boot` equivalent in an Orchestration service such as HEAT.

For example:

- `nova boot -user-data </path/to/vsrx_configuration.txt> --image vSRX_image --flavor vSRX_flavor_instance`
- `openstack server create -user-data </path/to/vsrx_configuration.txt> --image vSRX_image --flavor vSRX_flavor_instance`

Where:

`-user-data </path/to/vsrx_configuration.txt>` specifies the location of the Junos OS configuration file. The user-data configuration file size is limited to approximately 16,384 bytes.

`--image vSRX_image` identifies the name of a unique vSRX Virtual Firewall image.

`--flavor vSRX_flavor_instance` identifies the vSRX Virtual Firewall flavor (ID or name).

Starting in Junos OS Release 15.1X49-D130 and Junos OS Release 18.4R1, to enable the use of a configuration drive for a specific request in the OpenStack compute environment, include the `-config-drive true` parameter in the `nova boot` or `openstack server create` command.

**NOTE:** It is possible to enable the configuration drive automatically on all instances by configuring the OpenStack Compute service to always create a configuration drive. To do this, specify the `force_config_drive=True` option in the `nova.conf` file.

For example, to use the user-data attribute to pass the Junos OS configuration to each vSRX Virtual Firewall instance:

```
nova boot -config-drive true -flavor vSRX_flavor_instance -image vSRX_image -user-data </path/to/vsrx_configuration.txt>
```

Where:

`-user-data </path/to/vsrx_configuration.txt>` specifies the location of the Junos OS configuration file. The user-data configuration file size is limited to approximately 64 MB.

`-image vSRX_image` identifies the name of a unique vSRX Virtual Firewall image.

`-flavor vSRX_flavor_instance` identifies the vSRX Virtual Firewall flavor (ID or name).

For example, to specify the configuration drive with multiple files (Junos OS configuration file and license file):

```
nova boot -config-drive true -flavor vSRX_flavor_instance -image vSRX_image [-file /config/junos-config/configuration.txt=/path/to/file] [-file /junos-license/license.lic=/path/to/license]
```

Where:

`[-file /config/junos-config/configuration.txt=/path/to/file]` specifies the location of the Junos OS configuration file.

`[-file /config/junos-license/license.lic=path/to/license]` specifies the location of the Junos OS configuration file.

`-image vSRX_image` identifies the name of a unique vSRX Virtual Firewall image.

`-flavor vSRX_flavor_instance` identifies the vSRX Virtual Firewall flavor (ID or name).

4. Boot or reboot the vSRX Virtual Firewall instance. During the initial boot-up sequence, the vSRX Virtual Firewall instance processes the cloud-init request.

**NOTE:** The boot time for the vSRX Virtual Firewall instance might increase with the use of the cloud-init package. This additional time in the initial boot sequence is due to the operations performed by the cloud-init package. During this operation, the cloud-init package halts the boot sequence and performs a lookup for the configuration data in each data source identified in the cloud.cfg. The time required to look up and populate the cloud data is directly proportional to the number of data sources defined. In the absence of a data source, the lookup process continues until it reaches a predefined timeout of 30 seconds for each data source.

5. When the initial boot-up sequence resumes, the user-data file replaces the original factory-default Junos OS configuration loaded on the vSRX Virtual Firewall instance. If the commit succeeds, the factory-default configuration will be permanently replaced. If the configuration is not supported or cannot be applied to the vSRX Virtual Firewall instance, the vSRX Virtual Firewall will boot using the default Junos OS configuration.

## SEE ALSO

[Cloud-Init Documentation](#)

[OpenStack command-line clients](#)

[Compute service \(nova\) command-line client](#)

[Openstack Server Create](#)

[Enabling the configuration drive \(configdrive\)](#)

[Instances](#)

## Perform Automatic Setup of a vSRX Virtual Firewall Instance from the OpenStack Dashboard (Horizon)

Horizon is the canonical implementation of the OpenStack Dashboard. It provides a Web-based user interface to OpenStack services including Nova, Swift, Keystone, and so on. You can launch and manage

a vSRX Virtual Firewall instance from the OpenStack Dashboard, which includes the use of a validated Junos OS configuration user-data file from your local directory to initialize the active configuration of the target vSRX Virtual Firewall instance.

To initiate the automatic setup of a vSRX Virtual Firewall instance from the OpenStack Dashboard:

1. If you have not done so already, create a configuration file with the Junos OS command syntax and save the file. The configuration file can be plain text or MIME file type text/plain.

The user-data configuration file must contain the full vSRX Virtual Firewall configuration that is to be used as the active configuration on each vSRX Virtual Firewall instance, and the string `#junos-config` must be the first line of the user-data configuration file before the Junos OS configuration.

**NOTE:** The `#junos-config` string is mandatory in the user-data configuration file; if it is not included, the configuration will not be applied to the vSRX Virtual Firewall instance as the active configuration.

2. Copy the Junos OS configuration file to an accessible location from where it can be retrieved to launch the vSRX Virtual Firewall instance.
3. Log in to the OpenStack Dashboard using your login credentials and then select the appropriate project from the drop-down menu at the top left.
4. On the Project tab, click the **Compute** tab and select **Instances**. The dashboard shows the various instances with its image name, its private and floating IP addresses, size, status, availability zone, task, power state, and so on.
5. Click **Launch Instance**. The Launch Instance dialog box appears.
6. From the Details tab (see [Figure 5 on page 55](#)), enter an instance name for the vSRX Virtual Firewall VM along with the associated availability zone (for example, Nova) and then click **Next**. We recommend that you keep this name the same as the hostname assigned to the vSRX Virtual Firewall VM.

Figure 62: Launch Instance Details Tab

Launch Instance

Please provide the initial hostname for the instance, the availability zone where it will be deployed, and the instance count. Increase the Count to create multiple instances with the same settings.

**Details**

**Source \***

**Flavor \***

**Networks \***

**Network Ports**

**Security Groups**

**Key Pair**

**Configuration**

**Metadata**

**Instance Name \***

vsrx-cloud-init-user-data

**Availability Zone**

nova

**Count \***

1

Total Instances (100000 Max)

0%

6 Current Usage

1 Added

99993 Remaining

✕ Cancel

< Back

Next >

Launch Instance

- From the Source tab (see [Figure 6 on page 56](#)), select a vSRX Virtual Firewall VM image source file from the Available list and then click **+(Plus)**. The selected vSRX Virtual Firewall image appears under Allocated. Click **Next**.

Figure 63: Launch Instance Source Tab

Launch Instance ✕

?

**Details**

**Source**

Instance source is the template used to create an instance. You can use a snapshot of an existing instance, an image, or a volume (if enabled). You can also choose to use persistent storage by creating a new volume.

**Flavor \***

**Networks \***

**Network Ports**

**Security Groups**

**Key Pair**

**Configuration**

**Metadata**

**Select Boot Source**

Image

Allocated

| Name              | Updated        | Size    | Type  | Visibility |   |
|-------------------|----------------|---------|-------|------------|---|
| ➤ vsrx-cloud-init | 5/6/17 5:46 AM | 3.07 GB | QCOW2 | Public     | - |

▼ Available 3 Select one

🔍 Click here for filters.

| Name ^         | Updated         | Size     | Type  | Visibility |   |
|----------------|-----------------|----------|-------|------------|---|
| ➤ Centos_image | 4/4/17 6:09 AM  | 12.67 MB | RAW   | Public     | + |
| ➤ vsrx         | 5/10/17 5:25 PM | 3.07 GB  | QCOW2 | Public     | + |
| ➤ vSRXD75      | 4/4/17 10:43 PM | 2.90 GB  | QCOW2 | Public     | + |

8. From the Flavor tab (see [Figure 7 on page 57](#)), select a vSRX Virtual Firewall instance with a specific compute, memory, and storage capacity from the Available list and then click **+(plus sign)**. The selected vSRX Virtual Firewall flavor appears under Allocated. Click **Next**.

Figure 64: Launch Instance Flavor Tab

Launch Instance

Flavors manage the sizing for the compute, memory and storage capacity of the instance.

Allocated

| Name        | VCPUS | RAM  | Total Disk | Root Disk | Ephemeral Disk | Public |   |
|-------------|-------|------|------------|-----------|----------------|--------|---|
| > m1.medium | 2     | 4 GB | 40 GB      | 40 GB     | 0 GB           | Yes    | - |

Available 6 Select one

Click here for filters.

| Name                  | VCPUS | RAM      | Total Disk | Root Disk | Ephemeral Disk | Public |   |
|-----------------------|-------|----------|------------|-----------|----------------|--------|---|
| > m1.tiny             | 1     | 512 MB   | 1 GB       | 1 GB      | 0 GB           | Yes    | + |
| > m1.small            | 1     | 2 GB     | 20 GB      | 20 GB     | 0 GB           | Yes    | + |
| > vSRX2.0_3 CPU_      | 3     | 2.9 3 GB | 2 GB       | 2 GB      | 0 GB           | Yes    | + |
| > vSRX2.0_3 CPU_3Intf | 3     | 3.9 1 GB | 16 GB      | 16 GB     | 0 GB           | Yes    | + |
| > m1.large            | 4     | 8 GB     | 80 GB      | 80 GB     | 0 GB           | Yes    | + |
| > m1.xlarge           | 8     | 16 GB    | 160 GB     | 160 GB    | 0 GB           | Yes    | + |

- From the Networks tab (see [Figure 8 on page 58](#)), select the specific network of the vSRX Virtual Firewall instance from the Available list and then click **+(plus sign)**. The selected network appears under Allocated. Click **Next**.

**NOTE:** Do not update any parameters in the Network Ports, Security Groups, or Key Pair tabs in the Launch Instance dialog box.

Figure 65: Launch Instance Networks Tab

Launch Instance

Networks provide the communication channels for instances in the cloud.

▼ Allocated <sup>1</sup> Select networks from those listed below.

|     | Network | Subnets Associated                   | Shared | Admin State | Status |   |
|-----|---------|--------------------------------------|--------|-------------|--------|---|
| ⇅ 1 | MgmtVN  | b9803761-3b3b-4853-b9a0-6f1cef808102 | No     | Up          | Active | - |

▼ Available <sup>4</sup> Select at least one network

🔍 Click here for filters.

|   | Network ^ | Subnets Associated                   | Shared | Admin State | Status |   |
|---|-----------|--------------------------------------|--------|-------------|--------|---|
| > | LeftVN    | a6fd1f2a-4bcd-4485-a1da-491162d4abdc | No     | Up          | Active | + |
| > | MgmtVN2   | cb5625bd-880f-4c2d-a50a-277ed48d6e0f | No     | Up          | Active | + |
| > | Other0VN  | 7466febf-a26a-47a3-8d0c-e1906661cf23 | No     | Up          | Active | + |
| > | RightVN   | 516ded2c-b58f-4cfb-aba6-12e584de6b8b | No     | Up          | Active | + |

✕ Cancel < Back Next > Launch Instance

- From the Configuration tab (see [Figure 9 on page 59](#)), click **Browse** and navigate to the location of the validated Junos OS configuration file from your local directory that you want to use as the user-data file. Click **Next**.



Figure 66: Launch Instance Configuration Tab

The screenshot shows the 'Launch Instance' dialog box with the 'Configuration' tab selected. The left sidebar contains the following tabs: Details, Source, Flavor, Networks, Network Ports, Security Groups, Key Pair, Configuration (highlighted), and Metadata. The main content area has a header with a close button and a help icon. Below the header, there is a text block: 'You can customize your instance after it has launched using the options available here. "Customization Script" is analogous to "User Data" in other systems.' This is followed by a 'Customization Script' section with a text area and a 'Script size: 0 bytes of 16.00 KB' label. Below the text area is a 'Load script from a file' section with a 'Choose File' button and 'No file chosen' text. The 'Disk Partition' section has a dropdown menu set to 'Automatic' and an unchecked 'Configuration Drive' checkbox. At the bottom, there are three buttons: 'Cancel', '< Back', and 'Next >' (disabled), and a prominent orange 'Launch Instance' button.

11. Confirm that the loaded Junos OS configuration contains the `#junos-config` string in the first line of the user-data configuration file (see [Figure 10 on page 60](#)) and then click **Next**.

**NOTE:** Do not update any parameters in the Metadata tab of the Launch Instance dialog box.

Figure 67: Launch Instance Configuration Tab with Loaded Junos OS Configuration

The screenshot shows the 'Launch Instance' configuration window with the 'Configuration' tab selected. The window title is 'Launch Instance' and it has a close button (X) in the top right corner. A help icon (?) is also present in the top right. The left sidebar contains the following tabs: Details, Source, Flavor, Networks, Network Ports, Security Groups, Key Pair, Configuration (selected), and Metadata. The main content area displays the following information:

- Details:** You can customize your instance after it has launched using the options available here. "Customization Script" is analogous to "User Data" in other systems.
- Source:** Customization Script (Modified) Script size: 3.42 KB of 16.00 KB
- Configuration Script:** A text area containing the following Junos configuration:
 

```
#junos-config
## Last commit: 2017-05-01 18:43:01 UTC by root
version "15.1-2017-04-26.1_DEV_X_151_X49 [ssd-builder]";
groups {
  amoluser {
    system {
      root-authentication {
        ssh-rsa "ssh-rsa"
```
- Load script from a file:** A 'Choose File' button is followed by the text 'user-data'.
- Disk Partition:** A dropdown menu is set to 'Automatic'.
- Configuration Drive

At the bottom of the window, there are four buttons: 'Cancel' (with an X icon), '< Back', 'Next >', and 'Launch Instance' (with a cloud icon).

- Click **Launch Instance**. During the initial boot-up sequence, the vSRX Virtual Firewall instance processes the cloud-init request.

**NOTE:** The boot time for the vSRX Virtual Firewall instance might increase with the use of the cloud-init package. This additional time in the initial boot sequence is due to the operations performed by the cloud-init package. During this operation, the cloud-init package halts the boot sequence and performs a lookup for the configuration data in each data source identified in the cloud.cfg. The time required to look up and populate the cloud data is directly proportional to the number of data sources defined. In the absence of a data source, the lookup process continues until it reaches a predefined timeout of 30 seconds for each data source.

- When the initial boot-up sequence resumes, the user-data file replaces the original factory-default Junos OS configuration loaded on the vSRX Virtual Firewall instance. If the commit succeeds, the factory-default configuration will be permanently replaced. If the configuration is not supported or cannot be applied to the vSRX Virtual Firewall instance, the vSRX Virtual Firewall will boot using the default Junos OS configuration.

**SEE ALSO**[Cloud-Init Documentation](#)[OpenStack Dashboard](#)[Launch and Manage Instances](#)[Horizon: The OpenStack Dashboard Project](#)**Release History Table**

| Release      | Description                                                                                                                                                                                                                                                                                                                                                                                                 |
|--------------|-------------------------------------------------------------------------------------------------------------------------------------------------------------------------------------------------------------------------------------------------------------------------------------------------------------------------------------------------------------------------------------------------------------|
| 15.1X49-D130 | Starting in Junos OS Release 15.1X49-D130 and Junos OS Release 18.4R1, the cloud-init functionality in vSRX Virtual Firewall has been extended to support the use of a configuration drive data source in an OpenStack environment. The configuration drive uses the user-data attribute to pass a validated Junos OS configuration file to the vSRX Virtual Firewall instance.                             |
| 15.1X49-D100 | Starting in Junos OS Release 15.1X49-D100 and Junos OS Release 17.4R1, the cloud-init package (version 0.7x) comes pre-installed in the vSRX Virtual Firewall image to help simplify configuring new vSRX Virtual Firewall instances operating in an OpenStack environment according to a specified user-data file. Cloud-init is performed during the first-time boot of a vSRX Virtual Firewall instance. |

# vSRX Virtual Firewall VM Management with Contrail

## IN THIS CHAPTER

- [Connect to the vSRX Virtual Firewall Management Console | 291](#)
- [Manage the vSRX Virtual Firewall VM | 292](#)
- [Upgrade Multicore vSRX Virtual Firewall with Contrail | 294](#)
- [Monitor vSRX Virtual Firewall with Contrail | 297](#)

## Connect to the vSRX Virtual Firewall Management Console

### IN THIS SECTION

- [Connect to the vSRX Virtual Firewall Management Console with Horizon | 291](#)
- [Connect to the vSRX Virtual Firewall Management Console with Contrail | 291](#)

Ensure that you have launched the vSRX Virtual Firewall VM with Contrail.

You can connect to the vSRX Virtual Firewall console through OpenStack or Contrail.

### Connect to the vSRX Virtual Firewall Management Console with Horizon

To connect to the vSRX Virtual Firewall console with OpenStack Horizon:

1. From the Horizon GUI, select your project, and select **Compute>Instances**. The list of existing instances appears.
2. From the Actions column, select **Console** from the More list. The vSRX Virtual Firewall console appears, and you can log in to the management port for the vSRX Virtual Firewall instance.

### Connect to the vSRX Virtual Firewall Management Console with Contrail

To connect to the vSRX Virtual Firewall console of a vSRX Virtual Firewall VM with Contrail:

1. From the Contrail GUI, select your project, and select **Configure>Services>Service Instances**. The list of existing service instances appears.
2. Click on the left arrow next to the vSRX Virtual Firewall VM to expand to the Service Instance Details view.
3. Click the **View Console** link on the right. The vSRX Virtual Firewall console appears, and you can log in to the management port for the vSRX Virtual Firewall.

## RELATED DOCUMENTATION

[OpenStack End User Guide](#)

[Contrail - Creating an In-Network or In-Network-NAT Service Chain](#)

## Manage the vSRX Virtual Firewall VM

### IN THIS SECTION

- [Power On the VM from OpenStack | 292](#)
- [Pause the VM | 293](#)
- [Restart the VM | 293](#)
- [Power Off the VM from OpenStack | 293](#)
- [Delete the vSRX Virtual Firewall VM from Contrail | 293](#)

Each vSRX Virtual Firewall instance is an independent *virtual machine* (VM) that you can power on, pause, or shut down.

### Power On the VM from OpenStack

To power on the VM:

1. From the OpenStack dashboard for your project, select **Compute>Instances**. The list of existing instances appears.
2. Check the VM you want to power on.
3. From the Actions column, select **Start Instance** from the list.

## Pause the VM

To pause the VM:

1. From the Horizon GUI for your project, select **Compute>Instances**. The list of existing instances appears.
2. Check the VM that you want to pause.
3. From the Actions column, select **Pause Instance** from the list.

## Restart the VM

To restart the VM:

1. From the Horizon GUI for your project, select **Compute>Instances**. The list of existing instances appears.
2. Check the VM that you want to reboot.
3. Select **Soft Reboot Instance** from the More list to restart the VM.

## Power Off the VM from OpenStack

To power off the VM:

1. From the OpenStack dashboard for your project, select **Compute>Instances**. The list of existing instances appears.
2. Check the VM you want to power off.
3. From the Actions column, select **Console** from the list. The console opens.
4. From the console, power off the VM.

```
user@host>request system power-off
```

## Delete the vSRX Virtual Firewall VM from Contrail

**BEST PRACTICE:** We recommend that you use Contrail to delete any VMs used in service chains created by Contrail.

To delete the VM from Contrail:

1. From the Contrail GUI for your project, select **Configure>Services>Service Instances**. The list of existing service instances appears.
2. Select the VM that you want to delete.
3. Click trash icon on the upper right menu to delete the selected VMs.

## RELATED DOCUMENTATION

[Contrail - Creating an In-Network or In-Network-NAT Service Chain](#)

[OpenStack End User Guide](#)

## Upgrade Multicore vSRX Virtual Firewall with Contrail

### IN THIS SECTION

- [Configure Multi-queue Virtio Interface for vSRX Virtual Firewall VM with OpenStack | 294](#)
- [Modify an Image Flavor for vSRX Virtual Firewall with the Dashboard | 295](#)
- [Update a Service Template | 296](#)

Starting in Junos OS Release 15.1X49-D70 and Junos OS Release 17.3R1, you can scale up the number of vCPUs or vRAM for a vSRX Virtual Firewall VM. You must gracefully power off the vSRX Virtual Firewall VM before you can scale up vSRX Virtual Firewall. See *Manage the vSRX VM* for details.

You can modify an existing flavor with the OpenStack Dashboard (Horizon). You cannot use the OpenStack CLI (`nova flavor`) commands to modify the CPU or RAM settings on an existing flavor. Instead, create a new flavor and modify the vSRX Virtual Firewall service template in Contrail to use this new flavor. See the *Create an Image Flavor with OpenStack* for details.

**NOTE:** You cannot scale down the number of vCPUs or vRAM for an existing vSRX Virtual Firewall VM.

### Configure Multi-queue Virtio Interface for vSRX Virtual Firewall VM with OpenStack

Before you plan to scale up vSRX Virtual Firewall performance, enable network multi-queuing as a means to support an increased number of dataplane vCPUs for the vSRX Virtual Firewall VM. The default for vSRX Virtual Firewall in Contrail is 2 dataplane vCPUs, but you can scale that number to 4 vCPUs.

To use multiqueue virtio interfaces, ensure your system meets the following requirements:

OpenStack Liberty supports the ability to create VMs with multiple queues on their virtio interfaces. Virtio is a Linux platform for I/O virtualization, providing a common set of I/O virtualization drivers.

Multiqueue virtio is an approach that enables the processing of packet sending and receiving to be scaled to the number of available virtual CPUs (vCPUs) of a guest, through the use of multiple queues

**NOTE:** VIRTIO has a limitation of maximum of 64 MAC addresses per interface. If deploying a protocol which creates its own MAC (like VRRP), then you must ensure that sub-interfaces per interface does not exceed the limit of 64 MAC addresses. If the MAC address limit is exceeded then, there will be traffic loss.

- The OpenStack version must be Liberty or greater.
- The maximum number of queues in the vSRX Virtual Firewall VM interface is set to the same value as the number of vCPUs in the guest.
- The vSRX Virtual Firewall VM image metadata property is set to enable multiple queues inside the VM.

Use the following command on the OpenStack node to enable multiple queues on a vSRX Virtual Firewall VM in Contrail:

```
source /etc/contrail/openstackrc
```

```
nova image-meta <image_name> set hw_vif_multiqueue_enabled="true"
```

After the vSRX Virtual Firewall VM is spawned, use the following command on the virtio interface in the guest to enable multiple queues inside the vSRX Virtual Firewall VM:

```
ethtool -L <interface_name> combined <#queues>
```

## Modify an Image Flavor for vSRX Virtual Firewall with the Dashboard

OpenStack uses VM templates, or flavors, to set the memory, vCPU, and storage requirements for an image.

To Modify an image flavor for vSRX Virtual Firewall with the OpenStack dashboard:

1. From the dashboard select your project, and select **Admin>System Panel>Flavors**. The list of existing image flavors appears, as shown in [Figure 68 on page 296](#).



Figure 68: OpenStack Flavors

| Flavor Name | VCPUs | RAM    | Root Disk | Ephemeral Disk | Swap Disk | ID                                   | Public | Metadata | Actions     |
|-------------|-------|--------|-----------|----------------|-----------|--------------------------------------|--------|----------|-------------|
| m1.tiny     | 1     | 512MB  | 1GB       | 0GB            | 0MB       | 1                                    | Yes    | No       | Edit Flavor |
| m1.small    | 1     | 2048MB | 20GB      | 0GB            | 0MB       | 2                                    | Yes    | No       | Edit Flavor |
| vSRX1.0     | 2     | 2048MB | 2GB       | 0GB            | 0MB       | c3f24e6f-25df-4014-bfd8-5d42b56adbab | Yes    | No       | Edit Flavor |
| vsrxff2     | 2     | 4096MB | 20GB      | 0GB            | 0MB       | ede2ecd6-99d2-4a19-870a-49298e2726ac | Yes    | No       | Edit Flavor |

2. Select the vSRX Virtual Firewall flavor and click **Edit Flavor**. The Edit Flavor dialog box appears.
3. Increase the number of vCPUs for your configuration. The minimum required for vSRX Virtual Firewall is 2 vCPUs.
4. Increase the RAM MB value. The minimum required for vSRX Virtual Firewall is 4096 MB.
5. Click **Create Flavor**. The flavor appears on the Flavors tab.

## Update a Service Template

If you created a new image flavor for an existing vSRx instance, you need to update the service template to use this new image flavor before you relaunch the vSRX Virtual Firewall instance.

To update a service template:

1. From Contrail, select **Configure>Services>Service Templates**. The list of existing service templates appears.
2. Click on the vSRX Virtual Firewall service template and select edit.
3. Expand **Advanced Options** and select the new instance flavor from the Instance Flavor list.
4. Click **Save** to update this service template.
5. Power on the vSRX Virtual Firewall VM. See *Manage the vSRX VM* for details.

## Release History Table

| Release     | Description                                                                                                                                        |
|-------------|----------------------------------------------------------------------------------------------------------------------------------------------------|
| 15.1X49-D70 | Starting in Junos OS Release 15.1X49-D70 and Junos OS Release 17.3R1, you can scale up the number of vCPUs or vRAM for a vSRX Virtual Firewall VM. |

## RELATED DOCUMENTATION

[OpenStack Installation Guide](#)

[OpenStack End User Guide](#)

## Monitor vSRX Virtual Firewall with Contrail

To monitor basic statistics on the vSRX Virtual Firewall VM with Contrail:

1. On Contrail, select **Monitor>Networking>Instances**. The list of existing VMs appears.
2. Expand the row for the VM that you want to monitor. The CPU and memory statistics appear.
3. On Contrail, select **Monitor>Networking>Networks**. The list of existing virtual networks appears.
4. Expand the row for the virtual network that you want to monitor and select **Traffic Statistics**. The traffic and throughput statistics appear.

## RELATED DOCUMENTATION

[Contrail - Monitor Networking](#)

# 5

PART

## vSRX Virtual Firewall Deployment for Nutanix

---

[Overview | 299](#)

[Install vSRX Virtual Firewall in Nutanix | 312](#)

---

# Overview

## IN THIS CHAPTER

- [Understand vSRX Virtual Firewall Deployment with Nutanix | 299](#)
- [Requirements for vSRX Virtual Firewall on Nutanix | 307](#)

## Understand vSRX Virtual Firewall Deployment with Nutanix

### IN THIS SECTION

- [Nutanix Platform Overview | 299](#)
- [vSRX Virtual Firewall Deployment with Nutanix Overview | 302](#)
- [Understand vSRX Virtual Firewall Deployment with Nutanix AHV | 304](#)
- [Sample vSRX Virtual Firewall Deployment Using Nutanix AHV | 306](#)

## Nutanix Platform Overview

### IN THIS SECTION

- [Guest VM Data Management | 300](#)

The Nutanix Virtual Computing Platform is a converged, scale-out compute and storage system that is purpose-built to host and store virtual machines (VMs).

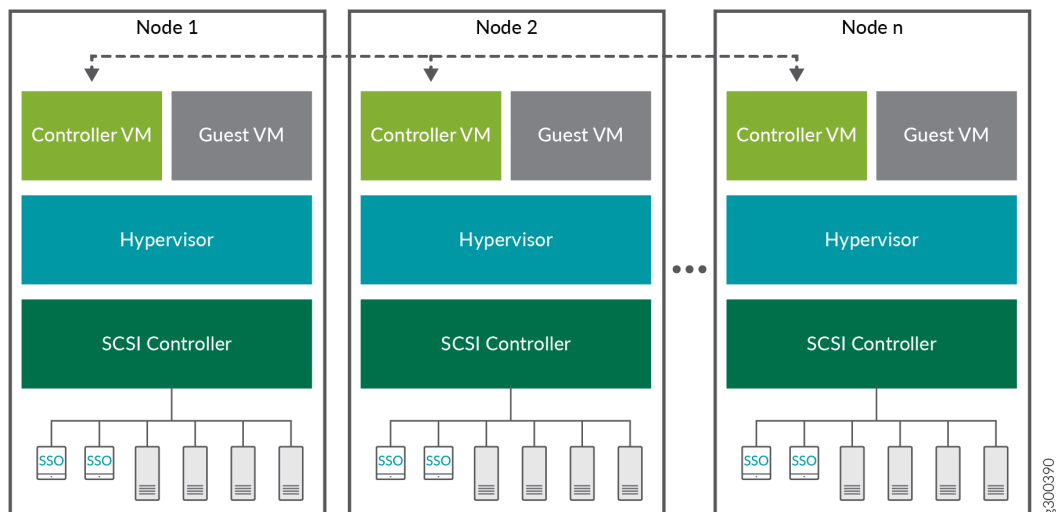
All nodes in a Nutanix cluster converge to deliver a unified pool of tiered storage and present resources to VMs for seamless access. A global data system architecture integrates each new node into the cluster,

allowing you to scale the solution to meet the needs of your infrastructure. Nutanix supports VMware vSphere (ESXi), Microsoft HyperV, Citrix XenServer, and Nutanix Acropolis hypervisor (AHV) (KVM-based).

The foundational unit for the cluster is a Nutanix node. Each node in the cluster runs a standard hypervisor and contains processors, memory, and local storage (SSDs and hard disks).

The Nutanix cluster has a distributed architecture, which means that each node in the cluster shares in the management of cluster resources and responsibilities. Within each node, there are software components that perform specific tasks during cluster operation. All components run on multiple nodes in the cluster, and depend on connectivity between their peers that also run the component. Most components also depend on other components for information.

A Nutanix Controller VM runs on each node, enabling the pooling of local storage from all nodes in the cluster.



### Guest VM Data Management

VM data is stored locally, and replicated on other nodes for protection against hardware failure.

When a guest VM submits a write request through the hypervisor, that request is sent to the Controller VM on the host. To provide a rapid response to the guest VM, this data is first stored on the metadata drive, within a subset of storage. This cache is rapidly distributed across the 10-Gigabit Ethernet GbE network to other metadata drives in the cluster. Oplog data is periodically transferred to persistent storage within the cluster. Data is written locally for performance and replicated on multiple nodes for high availability.

When the guest VM sends a read request through the hypervisor, the Controller VM will read from the local copy first, if present. If the host does not contain a local copy, then the Controller VM will read

across the network from a host that does contain a copy. As remote data is accessed, it will be migrated to storage devices on the current host, so that future read requests can be local.

Guest VM data management includes the following features:

- **MapReduce tiering**—Nutanix cluster dynamically manages data based on how frequently it is accessed. New data is saved on the SSD tier. Frequently accessed data is kept on the SSD tier and old data is migrated to the HDD tier.

Automated data migration also applies to read requests across the network. If a guest VM repeatedly accesses a block of data on a remote host, the local controller VM migrates that data to the SSD tier of the local host. This migration not only reduces network latency, but also ensures that frequently accessed data is stored on the fastest storage tier.

- **Live migration**—Live migration of VMs, whether it is initiated manually or through an automatic process like vSphere DRS, is fully supported by the Nutanix Virtual Computing Platform. All hosts within the cluster have visibility into shared Nutanix datastores through the Controller VMs. Guest VM data is written locally, and is also replicated on other nodes for high availability.

If a VM is migrated to another host, future read requests are sent to a local copy of the data, if it exists. Otherwise, the request is sent across the network to a host that does contain the requested data. As remote data is accessed, the remote data is migrated to storage devices on the current host, so that future read requests are local.

- **High availability (HA)**—The built-in data redundancy in a Nutanix cluster supports high availability provided by the hypervisor. If a node fails, all high-availability-protected VMs can be automatically restarted on other nodes in the cluster. The hypervisor management system, such as vCenter, selects a new host for the VMs, which might or might not contain a copy of the VM data.
- **Virtualization management VM high availability**—In virtualization management VM high availability, when a node becomes unavailable, VMs that are running on that node are restarted on another node in the same cluster.

Typically, an entity failure is detected by its isolation from the network (the failure to respond to heartbeats). Virtualization management ensures that at most one instance of the VM is running at any point during a failover. This property prevents concurrent network and storage I/O that could lead to corruption.

Virtualization management VM high availability implements admission control to help ensure that in case of node failure, the rest of the cluster has enough resources to accommodate the other VMs.

- **Datapath redundancy**—The Nutanix cluster automatically selects the optimal path between a hypervisor host and its guest VM data. The Controller VM has multiple redundant paths available, which makes the cluster more resilient to failures.

When available, the optimal path is through the local Controller VM to local storage devices. In some situations, the data is not available on local storage, such as when a guest VM was recently migrated to another host. In those cases, the Controller VM directs the read request across the network to storage on another host through the Controller VM of that host.

Datapath redundancy also responds when a local Controller VM is unavailable. To maintain the storage path, the cluster automatically redirects the host to another Controller VM. When the local Controller VM comes back online, the datapath is returned to this VM.

## vSRX Virtual Firewall Deployment with Nutanix Overview

### IN THIS SECTION

- [Benefits of vSRX Virtual Firewall with Nutanix | 303](#)

This topic provides an overview of vSRX Virtual Firewall deployment on Nutanix Enterprise Cloud.

vSRX Virtual Firewall offers the same full-featured advanced security as the physical Juniper Networks SRX Series Firewalls, but in a virtualized form factor. Handling speeds up to 100 Gbps, making it the industry's fastest virtual firewall. vSRX Virtual Firewall with Nutanix delivers:

- A single platform delivering high performance and predictable scale for any virtual workload.
- High-performance networking and security for scale-out virtual data centers.
- Flexibility with multi-hypervisor support (Hyper-V, ESXi, and Acropolis Hypervisor) and a full appliance portfolio for the right mix of compute and storage resources.
- VMs that keep running and are protected with VM-centric backups and integrated disaster recovery.
- Innovative Virtual Chassis Fabric architecture with automation capabilities for simplified management.

Manual, rigid, and static connectivity and security implementations might work in traditional network environments. In the multicloud era, however, where application requirements are highly dynamic, network security must be an agile and scalable partner to compute and storage.

Enterprise multiclouds typically employ perimeter security solutions like Nutanix Enterprise Cloud to block threats contained in north-south traffic entering or leaving the HCI. Effective as they are, these solutions cannot defend against threats introduced by compromised virtual machines (VMs) that infect east-west traffic flowing within the data center itself, between applications and services. If these threats are not identified and addressed in a timely manner, they could compromise mission-critical applications

and lead to the loss of sensitive data, causing irreparable harm to revenue and reputation of an organization.

vSRX Virtual Firewall works with Nutanix Enterprise Cloud to provide advanced security, consistent management, automated threat remediation, and effective microsegmentation—delivering a secure and automated solution for defending today's multicloud environments.

The joint Juniper Networks-Nutanix hyperconverged solution helps enterprises secure their multicloud environments with advanced security, consistent management, automated threat remediation, automation, and effective microsegmentation. Enterprises can now easily deploy a secure and automated multicloud without the overhead of operational and management complexity.

Nutanix provides on-demand services in the cloud. Services range from Infrastructure as a Service (IaaS) and Platform as a Service (PaaS), to Application and Database as a Service. Nutanix is a highly flexible, scalable, and reliable cloud platform. In Nutanix, you can host servers and services on the cloud as bring-your-own-license (BYOL) service.

### Benefits of vSRX Virtual Firewall with Nutanix

- **Advanced security**—Protects the business by delivering advanced security services, including user and application firewall, advanced threat prevention, and intrusion prevention.
- **Microsegmentation**—Employs microsegmentation to secure applications and defend against lateral threat propagation in the enterprise multicloud. Protects virtual workloads through effective microsegmentation.

Microsegmentation facilitates granular segmentation and control by applying security policies at the virtualized host level. From a security perspective, the more granular level at which a threat can be blocked, the more effective the defense will be in containing the threat's propagation. Administrators must augment their security solutions with microsegmentation and automated threat remediation, providing the visibility and control required to protect lateral data center traffic from common breaches.

- **Visibility**—Provides granular visibility and analytics into application, user, and IP behavior.
- **Automation**—Offers rich APIs and automation libraries from Nutanix and Juniper Networks to enable agile DevOps workflows; to deliver improved security response through unified automation of security and networking workflows.
- **Operational simplicity**—Streamlines and enables policy deployment and enforcement with single-pane management and simple, intuitive controls across multicloud deployments.



## Understand vSRX Virtual Firewall Deployment with Nutanix AHV

### IN THIS SECTION

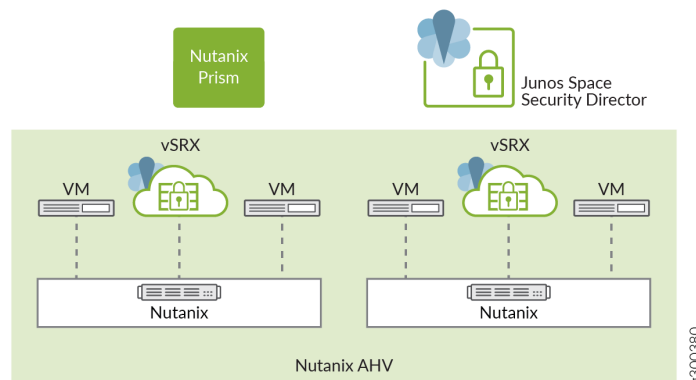
- [Components of vSRX Virtual Firewall Deployment with Nutanix | 305](#)

Nutanix Acropolis hyperconverged infrastructure (HCI) supports customer choice in virtualization solutions including VMware vSphere (ESXi), Microsoft HyperV, Citrix XenServer, and Nutanix AHV. AHV is a feature-rich Nutanix hypervisor. AHV is an enterprise-ready hypervisor based on proven open-source technology. Nutanix AHV is a license-free virtualization solution included with Acropolis that delivers enterprise virtualization ready for a multicloud world. With Acropolis and AHV, virtualization is tightly integrated into the Nutanix Enterprise Cloud OS rather than being layered on as a standalone product that needs to be licensed, deployed and managed separately.

Common tasks such as deploying, cloning, and protecting VMs are managed centrally through Nutanix Prism, rather than utilizing disparate products and policies in a piecemeal strategy.

[Figure 69 on page 304](#) illustrates how security is provided for applications running in a private subnet of Nutanix Enterprise Cloud with AHV hypervisor.

**Figure 69: vSRX Virtual Firewall Deployment in Nutanix Enterprise Cloud**



The Nutanix AHV virtualization solution, including the tools you need to manage it, ships from the factory already installed and ready to go state so that you can have the system up and running as soon as you have racked the cluster and powered it on. When the system is up and running, you can maintain the environment through a simple HTML 5 Web UI. Prism Element, which is available on each cluster you deploy, integrates this UI with the overall Nutanix solution. You can access Prism Element through each individual Nutanix cluster through the cluster IP or any of the individual Nutanix Controller Virtual

Machine (CVM) IP addresses. Prism Element requires no additional software; it is built into every Nutanix cluster and incorporates support for AHV.

If you prefer a more centralized mechanism for managing your deployment, Prism Central is available from the Nutanix portal or can be deployed directly from the Nutanix cluster. Prism Central is a robust optional software appliance VM that can run on ESXi, Hyper-V, or AHV.

Prism Central is both a platform and a hypervisor-agnostic management interface, providing an aggregate view of your deployed Nutanix clusters. In addition to allowing you to view and manage the cluster, Prism Central provides insight into VMs, hosts, disks, and containers or pooled disks.

Prism Central provides a single pane of glass for managing not only multiple Nutanix clusters, but also the native Nutanix hypervisor, AHV. Unlike other hypervisors, AHV requires no additional back-end applications or database to maintain the data rendered in the UI.

Prism runs on every node in the cluster, but like other components, it elects a leader. All requests are forwarded from the followers to the leader using Linux iptables. This allows administrators to access Prism using any Controller VM IP address. If the Prism leader fails, a new leader is elected. The leader also communicates with the ESXi hosts for VM status and related information. Junos Space Security Director manages vSRX Virtual Firewall Virtual Firewalls deployed on each node of a Nutanix AHV cluster, and it acts as a unified security policy manager to apply consistent policies across all vSRX Virtual Firewall VMs in Nutanix-based private and public clouds (AWS/Azure).

Traffic between VMs and applications is redirected through the vSRX Virtual Firewall, allowing next-generation firewall security services with advanced threat prevention to be provisioned. Security policies enforced on traffic inside the Nutanix Enterprise Cloud augment the Nutanix HCI with microsegmentation, blocking sophisticated threats that propagate laterally while identifying and controlling application and user access. This enables security administrators to isolate and segment mission-critical applications and data using zero trust security principles.

### Components of vSRX Virtual Firewall Deployment with Nutanix

Joint solution with vSRX Virtual Firewall and Nutanix includes the following key components:

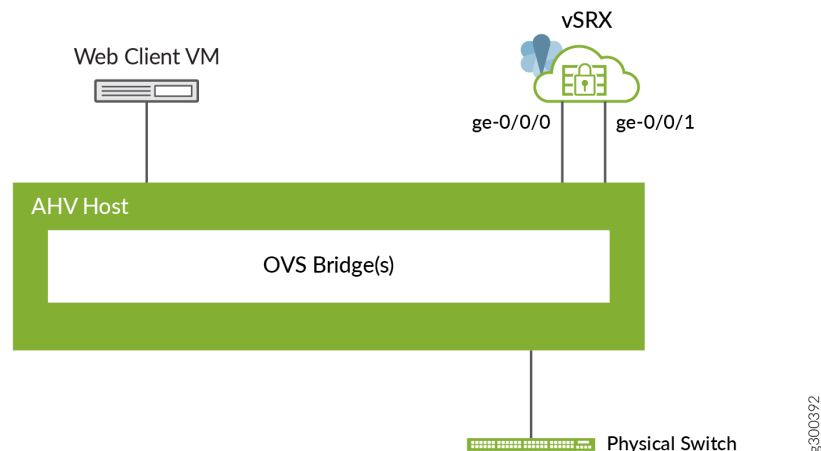
- **vSRX Virtual Firewall**—vSRX Virtual Firewall offers the same full-featured advanced security as the physical Juniper Networks SRX Series Firewalls, but in a virtualized form.
- **Junos Space Security Director**—Junos Space Security Director allows network operators to manage a distributed network of virtual and physical firewalls from a single location. Serving as the management interface for the vSRX Virtual Firewall Virtual Firewall, Security Director manages the firewall policies on all vSRX Virtual Firewall instances. It includes a customizable dashboard with details, threat maps, and event logs, providing unprecedented visibility into network security. Remote mobile monitoring is also possible through a mobile application for Google Android and Apple iOS systems.

- **Nutanix AHV**—Nutanix AHV is an enterprise-class virtualization solution included with the Nutanix Enterprise Cloud OS, with no additional software components to license, install, or manage. Starting with proven open-source virtualization technology, AHV combines an enhanced datapath for optimal performance, security hardening, flow network virtualization, and complete management features to deliver a leaner yet more powerful virtualization stack, no costly shelfware, and lower virtualization costs.
- **Nutanix Manager (Nutanix Prism)**—Nutanix Prism is an end-to-end management tool for administrators to configure and monitor the Nutanix cluster and solutions for virtualized data center environments using the nCLI and the Web console. The end-to-end management capability streamlines and automates common workflows, eliminating the need for multiple management solutions across data center operations. Powered by advanced machine learning technology, Prism analyzes system data to generate actionable insights for optimizing virtualization and infrastructure management.

### Sample vSRX Virtual Firewall Deployment Using Nutanix AHV

A Sample vSRX Virtual Firewall deployment to provide security for applications running in a private subnet of Nutanix Enterprise Cloud with AHV hypervisor is shown in [Figure 70 on page 306](#).

**Figure 70: Sample vSRX Virtual Firewall Deployment in Nutanix Enterprise Cloud Using AHV**



A vSRX Virtual Firewall image is loaded into the Linux-based kernel with Nutanix AHV virtualization solution as the hypervisor. AHV-based VMs support multitenancy, allowing you to run multiple vSRX Virtual Firewall VMs on the host OS. AHV manages and shares the system resources between the host OS and the multiple vSRX Virtual Firewall VMs.

**NOTE:** vSRX Virtual Firewall requires you to enable hardware-based virtualization on a host OS that contains an Intel Virtualization Technology (VT) capable processor.

The basic components of this deployment include:

- **Linux bridge**—Used for CVM control traffic
- **Open vSwitch (OVS) bridge(s)**—Used form VM traffic and to connect to physical ports
- **Physical switch**—Transports in or out traffic to the physical network ports on the host

### RELATED DOCUMENTATION

[Requirements for vSRX on KVM](#)

[Upgrade a Multi-core vSRX](#)

[Install vSRX with KVM](#)

## Requirements for vSRX Virtual Firewall on Nutanix

### IN THIS SECTION

- [System Requirements for Nutanix | 307](#)
- [Reference Requirements | 310](#)

These topics provide an overview of requirements for deploying a vSRX Virtual Firewall 3.0 instance on Nutanix.

### System Requirements for Nutanix

#### IN THIS SECTION

- [| 308](#)

- [Interface Mapping for vSRX Virtual Firewall 3.0 on Nutanix | 308](#)
- [vSRX Virtual Firewall 3.0 Default Settings on Nutanix | 309](#)
- [Best Practices for Improving vSRX Virtual Firewall 3.0 Performance | 310](#)

This topic provides the system requirement details.

[Table 60 on page 308](#) lists the system requirements for a vSRX Virtual Firewall 3.0 instance deployed on Nutanix.

**Table 60: System Requirements for vSRX Virtual Firewall 3.0**

| Component          | Specification and Details |
|--------------------|---------------------------|
| Hypervisor support | AHV 5.9                   |
| Memory             | 4 GB                      |
| Disk space         | 16 GB                     |
| vCPUs              | 2                         |
| vNICs              | Up to 8                   |
| vNIC type          | Virtio                    |

#### Interface Mapping for vSRX Virtual Firewall 3.0 on Nutanix

[Table 61 on page 309](#) shows the vSRX Virtual Firewall 3.0 and Nutanix interface names. The first network interface is used for the out-of-band management (fxp0) for vSRX Virtual Firewall 3.0.

**Table 61: vSRX Virtual Firewall 3.0 and Nutanix Interface Names**

| Interface Number | vSRX Virtual Firewall 3.0 Interface | Nutanix Interface |
|------------------|-------------------------------------|-------------------|
| 1                | fxp0                                | eth0              |
| 2                | ge-0/0/0                            | eth1              |
| 3                | ge-0/0/1                            | eth2              |
| 4                | ge-0/0/2                            | eth3              |
| 5                | ge-0/0/3                            | eth4              |
| 6                | ge-0/0/4                            | eth5              |
| 7                | ge-0/0/5                            | eth6              |
| 8                | ge-0/0/6                            | eth7              |

We recommend putting revenue interfaces in routing instances as a best practice to avoid asymmetric traffic/routing, because fxp0 is part of the default (inet.0) table by default. With fxp0 as part of the default routing table, there might be two default routes needed: one for the fxp0 interface for external management access, and the other for the revenue interfaces for traffic access. Putting the revenue interfaces in a separate routing instance avoids this situation of two default routes in a single routing instance.

**NOTE:** Ensure that interfaces belonging to the same security zone are in the same routing instance. See [KB Article - Interface must be in the same routing instance as the other interfaces in the zone.](#)

### vSRX Virtual Firewall 3.0 Default Settings on Nutanix

vSRX Virtual Firewall 3.0 requires the following basic configuration settings:

- Interfaces must be assigned IP addresses.

- Interfaces must be bound to zones.
- Policies must be configured between zones to permit or deny traffic.

Table 62 on page 310 lists the factory-default settings for security policies on the vSRX Virtual Firewall 3.0.

**Table 62: Factory-Default Settings for Security Policies**

| Source Zone | Destination Zone | Policy Action |
|-------------|------------------|---------------|
| trust       | untrust          | permit        |
| trust       | trust            | permit        |



**CAUTION:** Do not use the `load factory-default` command on a vSRX Virtual Firewall 3.0 Nutanix instance. The factory-default configuration removes the Nutanix preconfiguration. If you must revert to factory default, ensure that you manually reconfigure Nutanix preconfiguration statements before you commit the configuration; otherwise, you will lose access to the vSRX Virtual Firewall 3.0 instance. See *Configure vSRX Using the CLI* for Nutanix preconfiguration details.

### Best Practices for Improving vSRX Virtual Firewall 3.0 Performance

Refer the following deployment practices to improve vSRX Virtual Firewall 3.0 performance:

- Disable the source/destination check for all vSRX Virtual Firewall 3.0 interfaces.
- Limit public key access permissions to 400 for key pairs.
- Ensure that there are no contradictions between Nutanix security groups and your vSRX Virtual Firewall 3.0 configuration.
- Use vSRX Virtual Firewall 3.0 NAT to protect your instances from direct Internet traffic.

### Reference Requirements

Requirements for vSRX Virtual Firewall 3.0 with different types of Hypervisors are:

- **Requirements for vSRX on VMware**—See *Requirements for vSRX on VMware*
- **Requirements for vSRX on KVM-Based Hypervisor**—See *Requirements for vSRX on KVM*

- **Requirements for vSRX with Hype-V-Based Hypervisor**—See *Requirements for vSRX on Microsoft Hyper-V*



# Install vSRX Virtual Firewall in Nutanix

## IN THIS CHAPTER

- Launch and Deploy vSRX Virtual Firewall in Nutanix AHV Cluster | 312
- Upgrade the Junos OS for vSRX Virtual Firewall Software Release | 324

## Launch and Deploy vSRX Virtual Firewall in Nutanix AHV Cluster

### IN THIS SECTION

- Log In to Nutanix Setup | 312
- Adding a vSRX Virtual Firewall Image | 314
- Network Creation | 314
- Create and Deploy a vSRX Virtual Firewall VM | 315
- Power on the vSRX Virtual Firewall VMs | 322
- Launch vSRX Virtual Firewall VM Console | 323

Before you begin, you need a Nutanix account and an Identity and Access Management (IAM) role, with all required permissions to access, create, modify, and delete Nutanix cloud objects. You should also create access keys and corresponding secret access keys, X.509 certificates, and account identifiers. For better understanding of Nutanix terminologies and their use in vSRX Virtual Firewall deployments, see [Understanding vSRX with Nutanix](#).

The topics in this section help you launch vSRX Virtual Firewall instances in a Nutanix AHV cluster.

### Log In to Nutanix Setup

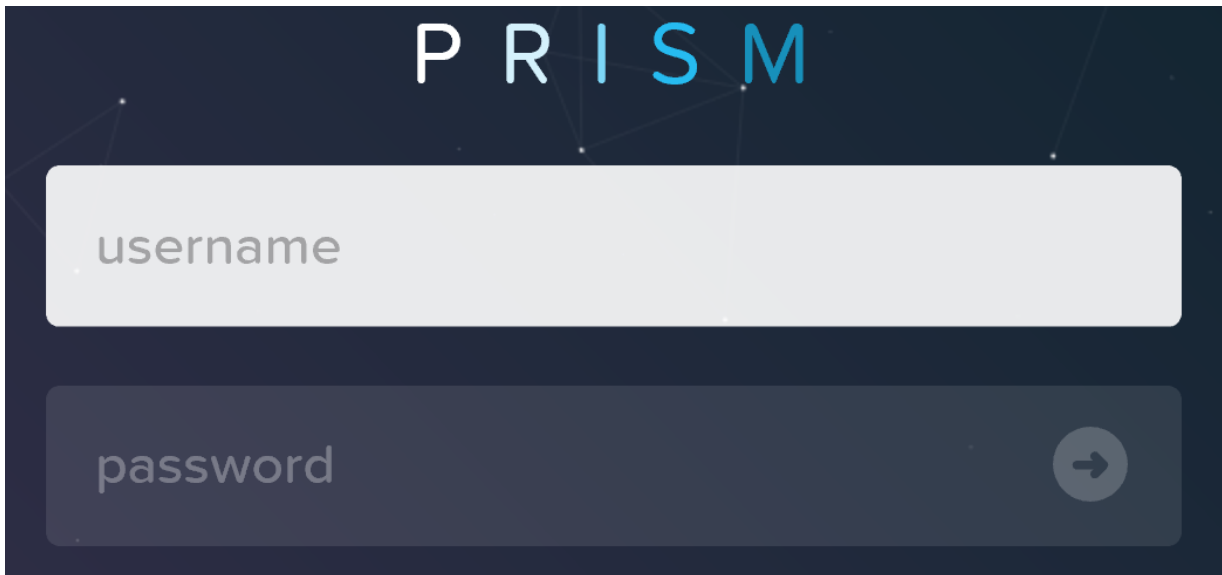
This topic provide details on how to log in to Nutanix setup.

Log in to the Nutanix Management Console.

**NOTE:** To access the Nutanix management console, remote access must be enabled on your local machine.

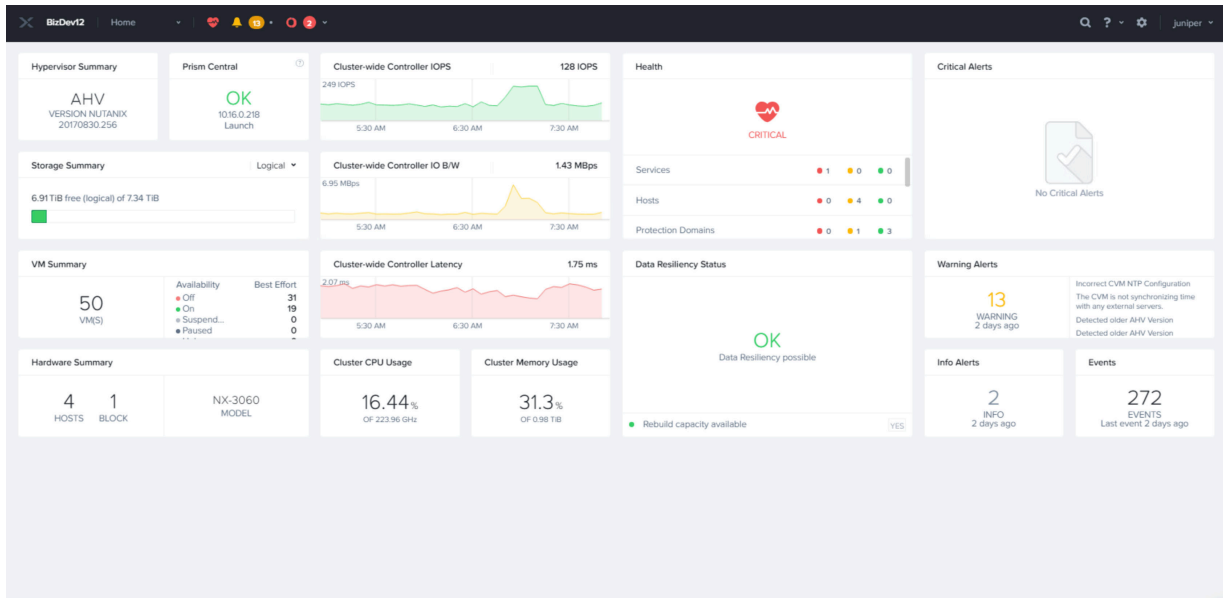
Once you have logged in to the remote Windows machine, you can access the Nutanix Prims Enable using your Web browser.

Figure 71: Prism Element Login Page



After you provide login details, the Nutanix Prism home page appears.

Figure 72: Initial Page of Prism Element



## Adding a vSRX Virtual Firewall Image

Before you create a vSRX Virtual Firewall image, copy the image in the local machine from which the image can be accessed by Nutanix Prism Element. After copying, locally source the images from Prism GUI.

All the required vSRX Virtual Firewall images are available in the Juniper download page. After you copy the vSRX Virtual Firewall image on the local machine, complete the following steps to upload the image in Nutanix:

1. Click the **Image configuration** option from the **Tool** menu in the on top-right corner of the Prism home page.
2. Click the **Upload Image** tab.
3. Enter the required image details and provide a local file path under Image source. Wait for the image to be uploaded successfully.

## Network Creation

This topic provides details on configuring the network for deploying vSRX Virtual Firewall VMs.

You can create a Routing Engine-FPC (RE-FPC) (or any other network) using the following steps:

1. At the top-right corner of the Nutanix Prism page, under Settings, click the **Network Configuration** option.
2. Click the **Create Network** button, add details for creating an internal network for RE-FPC communication, and click the **Save** button.

A message appears, indicating that the RE-FPC internal network was successfully created.

**NOTE:** In this deployment guide, all the the networks created on Nutanix setup are VLAN-based networks. Therefore, if you are deploying a Routing Engine and FPC on different hosts (compute nodes), the VLAN that is used by the RE-FPC internal networks must be part of the allowable VLAN range that is configured on the top-of-rack switch connecting the two machines. We tested the use case in which the Routing Engine and FPC were deployed on different hosts. However, for all our other tests, we deployed the Routing Engine and FPC on the same host.

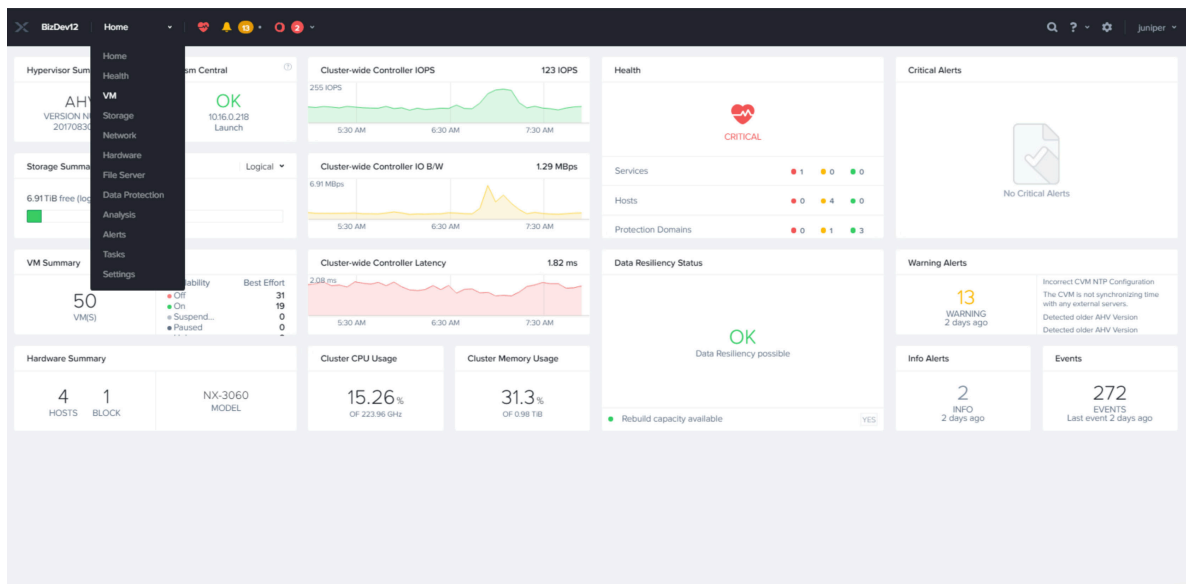
## Create and Deploy a vSRX Virtual Firewall VM

This topic provides details on how to deploy a vSRX Virtual Firewall VM.

In Acropolis-managed clusters, you can create a new virtual machine (VM) through the Web console. When creating a VM, you can configure all of its components, such as number of vCPUs and memory, but you cannot attach a volume group to the VM. Attaching a volume group is possible only when you are modifying a VM.

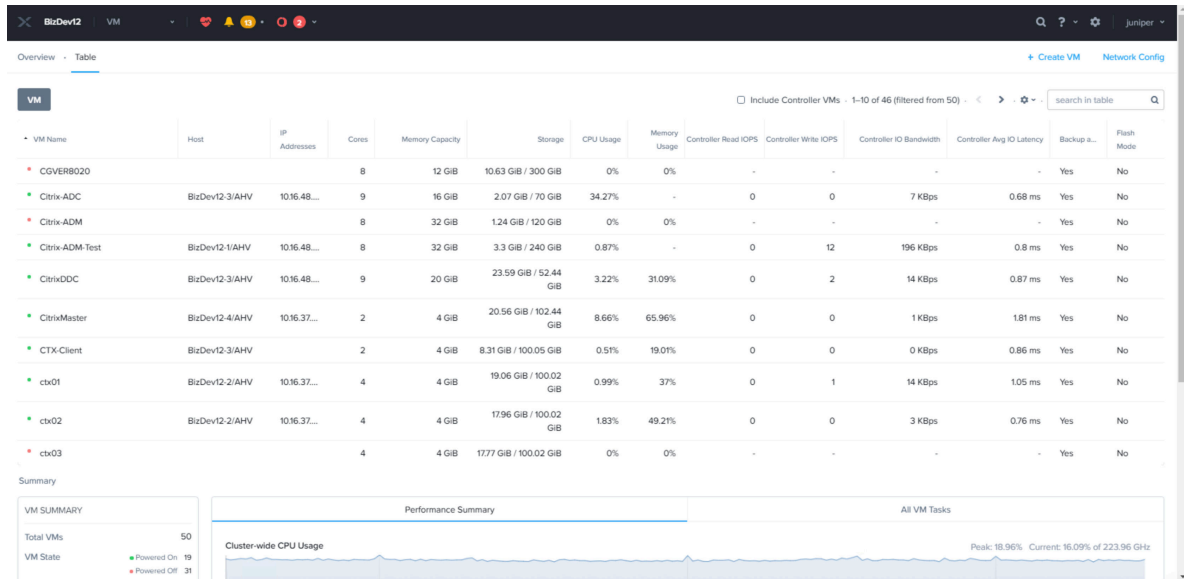
1. Click the **Home** menu at the top of the Prism home page and select the **VM** option from the drop-down list as shown in [Figure 73 on page 315](#).

**Figure 73: VM Option Page**



2. To create a VM, select the **VM** option under the Home tab (top-left corner) and click **+ Create VM** at the top-right side of the VM page as shown in [Figure 74 on page 316](#).

Figure 74: VM Page



The Create VM page appears as shown in [Figure 75 on page 317](#).

3. On the Create VM page, provide details of the indicated fields to create a vSRX Virtual Firewall VM as shown in [Figure 75 on page 317](#) and click the **Save** button.

- Name: Enter a name for the VM.
- Description (optional): Enter a description for the VM.
- vCPU(s): Enter the number of virtual CPUs to allocate to this VM.
- Number of Cores per vCPU: Enter the number of cores assigned to each virtual CPU.
- Memory: Enter the amount of memory to allocate to this VM.
- Select the time zone and update the compute details.

Figure 75: Create VM Page

The screenshot shows the 'Create VM' dialog box in the BizDev12 VM console. The dialog is open over a table of existing VMs. The 'General Configuration' section includes fields for Name, Description, and Timezone (set to UTC+05:30 Asia/Calcutta). The 'Compute Details' section includes fields for VCPUs (set to 1) and Number Of Cores Per Vcpu (set to 1). There are 'Cancel' and 'Save' buttons at the bottom.

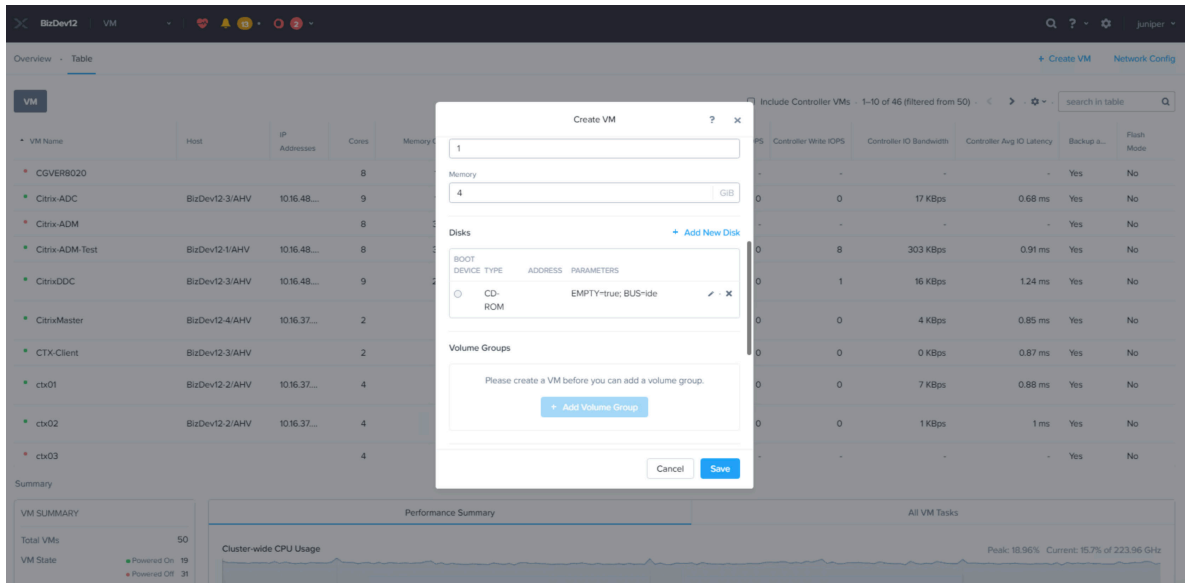
Figure 76: VM Compute Details Page

The screenshot shows the 'Create VM' dialog box in the BizDev12 VM console, showing the 'Compute Details' section. The 'VCPUs' field is set to 2, and the 'Memory' field is set to 4 GB. The 'Disks' section has an '+ Add New Disk' button. The 'BOOT' section shows a table with columns for DEVICE, TYPE, ADDRESS, and PARAMETERS.

| BOOT                  | DEVICE | TYPE | ADDRESS | PARAMETERS          |
|-----------------------|--------|------|---------|---------------------|
| <input type="radio"/> | CD-ROM |      |         | EMPTY=true; BUS=ide |

- To attach a disk to the vSRX Virtual Firewall VM, click the **+ Add New Disk** option on the **Create VM** page as shown in [Figure 77 on page 318](#).

Figure 77: VM Disk Details Page



5. The **Add Disk** page appears as shown in [Figure 78 on page 319](#). Select the vSRX Virtual Firewall Junos Image.

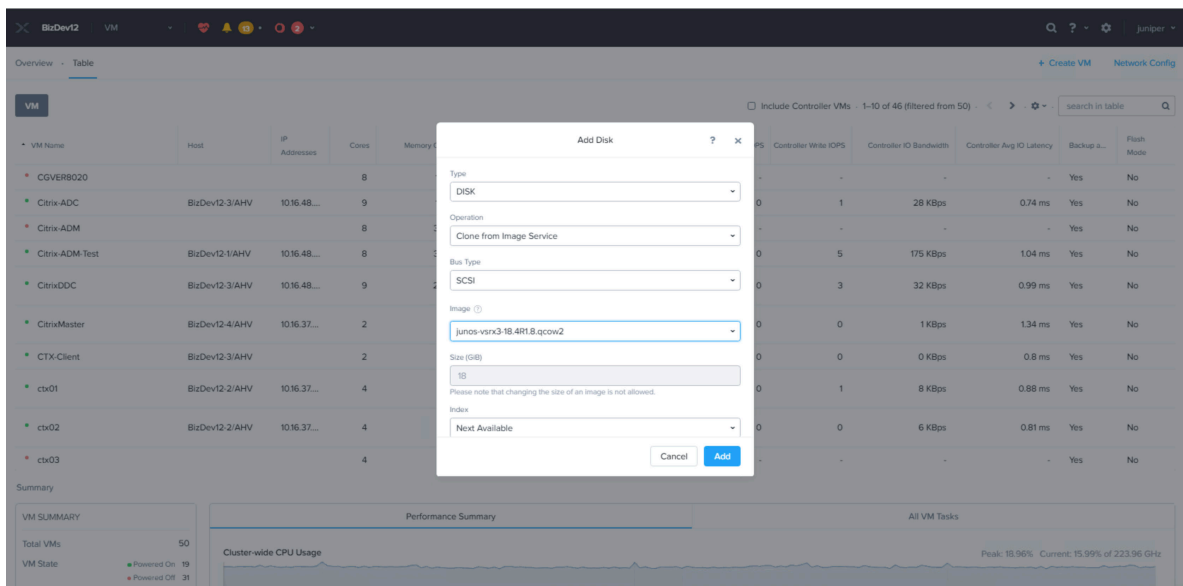
Do the following in the indicated fields and click on the **Add** button:

- **Type:** Select the type of storage device, **DISK** or **CDROM**, from the drop-down list. The following fields and options vary depending on whether you choose DISK or CDROM.
- **Operation:** Specify the device contents from the drop-down list.
  - Select **Clone from ADSF file** to copy any file from the cluster that can be used as an image onto the disk.
  - Select **Empty CDROM** to create a blank CD device. (This option appears only when CD is selected in the previous field.) A CD device is needed.
  - Select **Allocate on Container** to allocate space without specifying an image. (This option appears only when DISK is selected in the previous field.) Selecting this option means you are allocating space only. You have to provide a system image later from a CD or other source.
  - Select **Clone from Image Service** to copy an image that you have imported by using the image service feature onto the disk.
- **Bus Type:** Select the bus type from the drop-down list. The choices are IDE, SCSI, or SATA.
- **Path:** Enter the path to the desired system image.

**NOTE:** Field for entering the path appears only when Clone from ADSF file is selected. This file specifies the image to copy. For example, enter the pathname as /container\_name/iso\_name.iso. For example to clone an image from myos.iso in a container named crt1, enter /crt1/myos.iso. When a user types the container name (/container\_name/), a list appears of the ISO files in that container (If one or more ISO files had previously been copied to that container).

- Image: Select the image that you have created by using the image service feature. This field appears only when Clone from Image Service is selected. This field specifies the image to copy.
- Size: Enter the disk size in GiBs. This field appears only when Allocate on Container is selected.
- When all the field entries are correct, click the **Add** button to attach the disk to the VM and return to the Create VM page.
- Repeat Step 5 to attach additional devices to the VM.

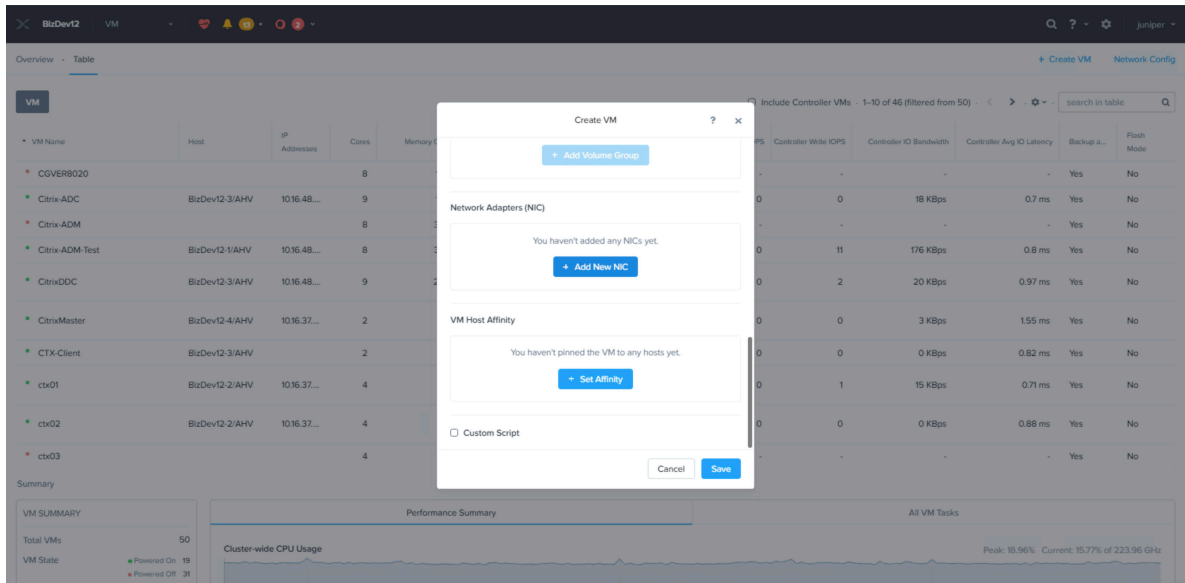
Figure 78: Add Disk Details Page



6. To create a network interface for the vSRX Virtual Firewall VM, click the **+ Add New NIC** option in the Create VM page as shown in [Figure 79 on page 320](#). Add the NICs required.



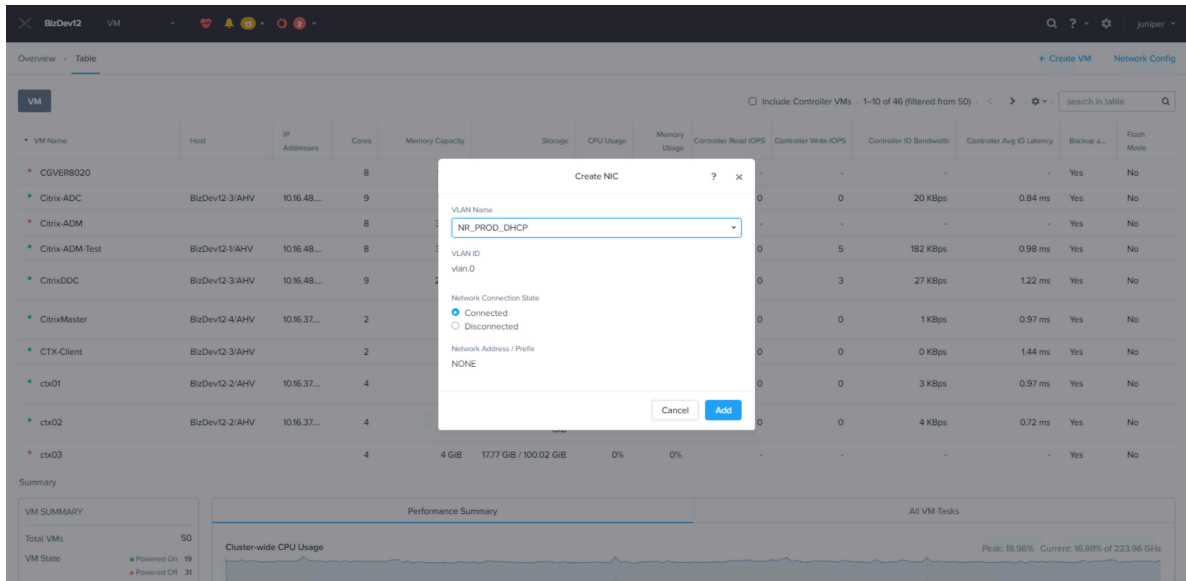
Figure 79: Add New NIC Option



The Create NIC page appears as shown in [Figure 80 on page 321](#). Do the following in the indicated fields:

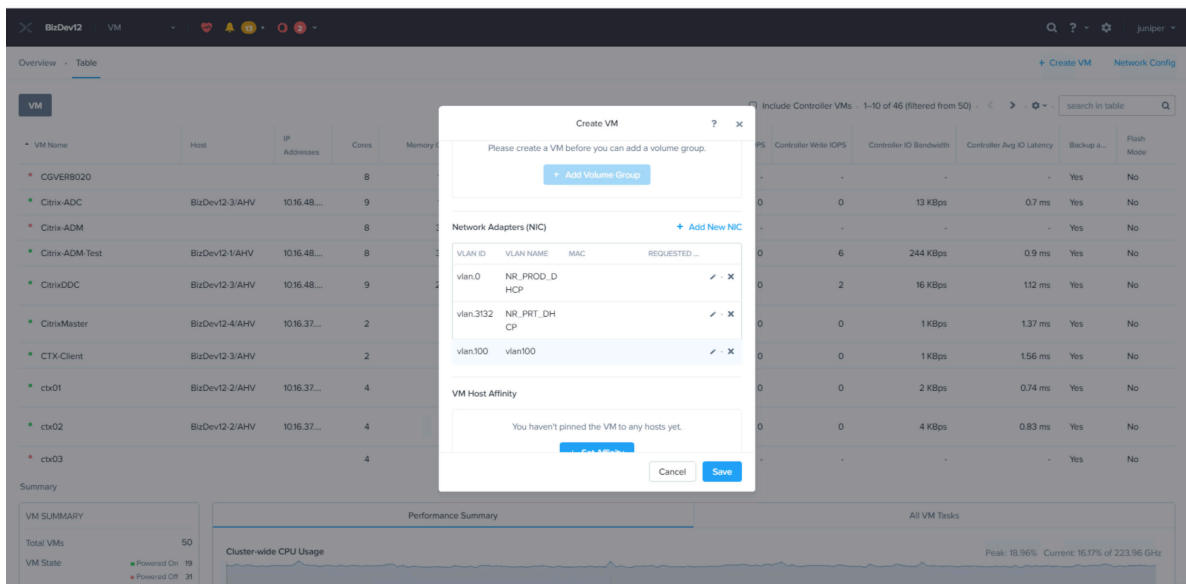
- **VLAN Name:** Select the target virtual LAN from the drop-down list.
- **VLAN ID:** This is a read-only field that displays the VLAN ID.
- **VLAN UUID:** This is a read-only field that displays the VLAN UUID.
- **Network Address/Prefix:** This is a read-only field that displays the network IP address and prefix.
- **IP Address:** Enter an IP address for the VLAN. This field appears only if the NIC is placed in a managed network. Entering an IP address in this field is optional when the network configuration provides an IP pool. If the field is left blank, the NIC is assigned an IP address from the pool.
- When all the field entries are correct, click the **Add** button to create a network interface for the VM and return to the Create VM page.
- Repeat this Step 6 to create additional network interfaces for the VM.

Figure 80: Create NIC Page



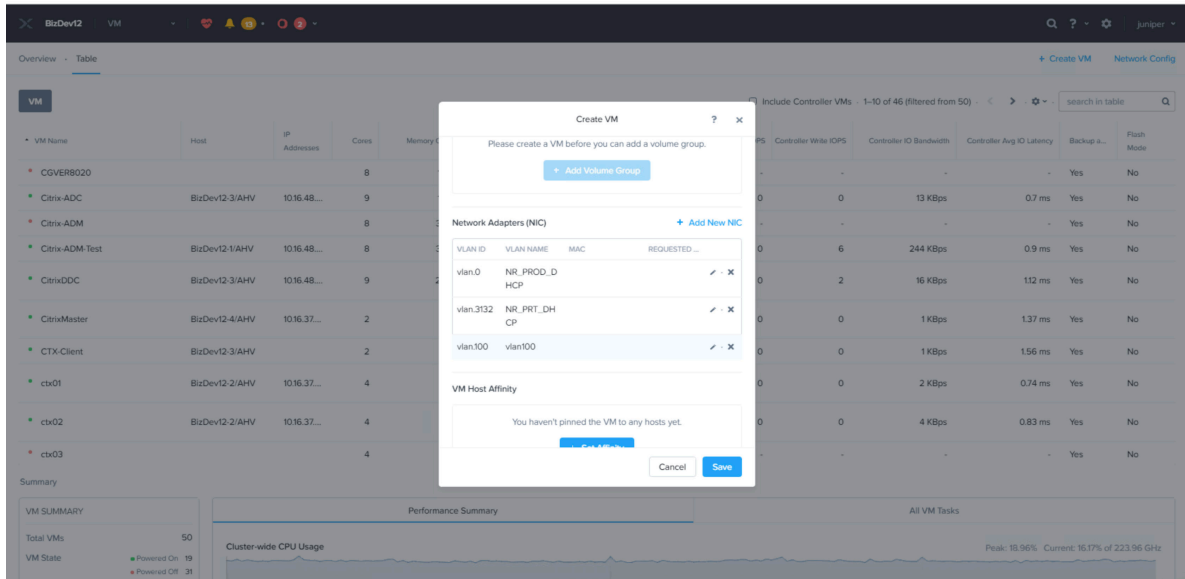
Repeat Step 6 and add more VLANs and NICs as needed.

Figure 81: Adding More VLANs and NICs



7. (Optional) If host affinity is needed, click **Set Affinity**..

Figure 82: VM Host Affinity Page



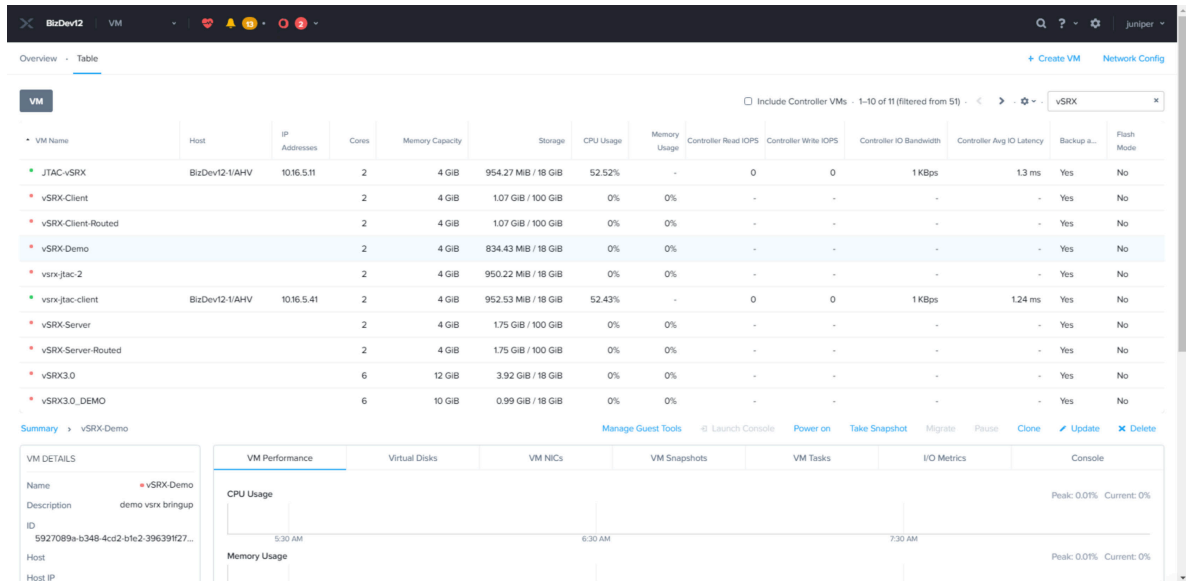
8. To customize the VM by using Cloud-init (for Linux VMs) or Sysprep (for Windows VMs), select the **Custom Script** check box.
9. When all the field entries are correct, click the **Save** button to create the VM and close the Create VM page.

## Power on the vSRX Virtual Firewall VMs

This topic provides you details on how to power on vSRX Virtual Firewall VMs.

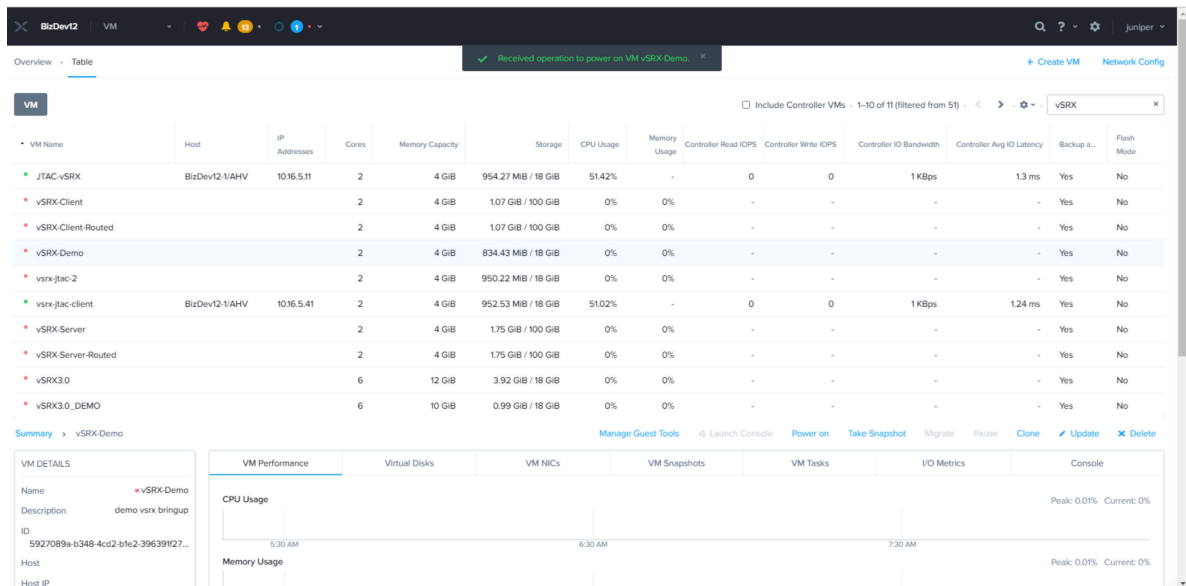
1. Use the Table drop-down list to search for VMs as shown in [Figure 83 on page 323](#).

Figure 83: Powering on VMs



- Click the **Power on** option (see Figure 83 on page 323) for each VM. All the VMs will turn on as shown in Figure 84 on page 323

Figure 84: Power on VM Confirmation Page



## Launch vSRX Virtual Firewall VM Console

This topic explains how to launch the vSRX Virtual Firewall VM console.

Click the **Launch Console** option at the bottom of screenshot as shown in [Figure 85 on page 324](#) to launch the VM console.

**Figure 85: Launch Console Page**

The screenshot displays the Juniper vMX interface for a vSRX Demo VM. The console window is open, showing the following output:

```

login: nic_uio0: Allocate 3 MSI-X
nic_uio0: Bar 1 @ fe020800, size 1090
nic_uio0: Allocate 3 MSI-X
nic_uio0: Bar 4 @ fe041000, size 4090
nic_uio0: Bar 1 @ fe020800, size 1090
nic_uio0: Bar 4 @ fe041000, size 4090
nic_uio1: Allocate 3 MSI-X
nic_uio1: Bar 1 @ fe030800, size 1090
nic_uio1: Allocate 3 MSI-X
nic_uio1: Bar 4 @ fe051000, size 4090
nic_uio1: Bar 1 @ fe030800, size 1090
nic_uio1: Bar 4 @ fe051000, size 4090

FreeBSD/amd64 (names iac) (tty0)
login:
FreeBSD/amd64 (names iac) (tty0)
login: root
--- JUNOS 10.4R1.8 Kernel 64-bit XEN JNPR-11.0-20181207.6c2f60b_2_ba
root@:~ #
  
```

The background interface shows a table of VMs with columns for Memory Usage, Controller Read IOPS, Controller Write IOPS, Controller IO Bandwidth, Controller Avg IO Latency, Backup a..., and Flash Mode. The 'vSRX' VM is highlighted. At the bottom, there are buttons for 'Launch Console', 'Power Off Actions', 'Take Snapshot', 'Migrate', 'Pause', 'Clone', 'Update', and 'Delete'.

## RELATED DOCUMENTATION

Day One: vSRX on KVM

## Upgrade the Junos OS for vSRX Virtual Firewall Software Release

You can upgrade the Junos OS for vSRX Virtual Firewall software using the CLI. Upgrading or downgrading Junos OS can take several hours, depending on the size and configuration of the network. Download the desired Junos OS Release for the vSRX Virtual Firewall 3.0 upgrade tgz file from the [Juniper Networks website](#). Example filename is `junos-install-vsrx3-x86-64-xxxxx.tgz`.

You also can upgrade using J-Web (see [J-Web](#)) or the Junos Space Network Management Platform (see [Junos Space](#)).

For the procedure on upgrading a specific Junos OS for vSRX Virtual Firewall software release, see the *Migration, Upgrade, and Downgrade Instructions* topic in the release-specific *vSRX Virtual Firewall Release Notes* available on the [vSRX TechLibrary](#) webpage.



# vSRX Virtual Firewall Deployment for AWS

---

[Overview | 326](#)

[Configure and Manage Virtual Firewall in AWS | 337](#)

[Virtual Firewall in AWS Use Cases | 437](#)

---

# Overview

## IN THIS CHAPTER

- [Understand vSRX Virtual Firewall with AWS | 326](#)
- [Requirements for vSRX Virtual Firewall on AWS | 332](#)

## Understand vSRX Virtual Firewall with AWS

### IN THIS SECTION

- [vSRX Virtual Firewall with AWS | 326](#)
- [AWS Glossary | 328](#)

This section presents an overview of vSRX Virtual Firewall on Amazon Web Services (AWS).

### vSRX Virtual Firewall with AWS

AWS provides on-demand services in the cloud. Services range from Infrastructure as a Service (IaaS) and Platform as a Service (PaaS), to Application and Database as a Service. AWS is a highly flexible, scalable, and reliable cloud platform. In AWS, you can host servers and services on the cloud as a pay-as-you-go (PAYG) or bring-your-own-license (BYOL) service.

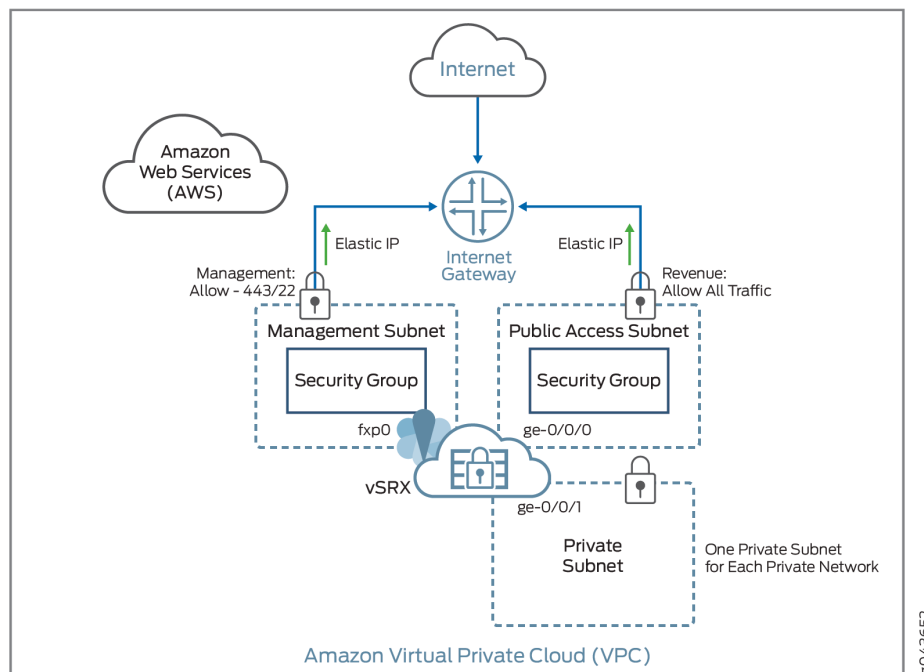
**NOTE:** vSRX Virtual Firewall PAYG images do not require any Juniper Networks licenses.

You can deploy vSRX Virtual Firewall in a virtual private cloud (VPC) in the Amazon Web Services (AWS) cloud. You can launch vSRX Virtual Firewall as an Amazon Elastic Compute Cloud (EC2) instance in an Amazon VPC dedicated to a specific user account. The vSRX Virtual Firewall Amazon Machine Image (AMI) uses hardware virtual machine (HVM) virtualization.

Figure 86 on page 327 shows an example of deploying a vSRX Virtual Firewall instance to provide security for applications running in a private subnet of an Amazon VPC.

In the Amazon VPC, public subnets have access to the Internet gateway, but private subnets do not. vSRX Virtual Firewall requires two public subnets and one or more private subnets for each individual instance group. The public subnets consist of one for the management interface (fxp0) and one for a revenue (data) interface. The private subnets, connected to the other vSRX Virtual Firewall interfaces, ensure that all traffic between applications on the private subnets and the Internet must pass through the vSRX Virtual Firewall instance.

Figure 86: vSRX Virtual Firewall in AWS Deployment



AWS Marketplace also enables you to discover and to subscribe to software that supports regulated workloads through AWS Marketplace for AWS GovCloud (US).

Starting in Junos OS Release 15.1X49-D70 and Junos OS Release 17.3R1, vSRX Virtual Firewall supports two bundles for PAYG that are available as 1-hour or 1-year subscriptions.

- vSRX Virtual Firewall Next Generation Firewall—Includes standard (STD) features of core security, including core firewall, IPsec VPN, NAT, CoS, and routing services, as well as advanced Layer 4 through 7 security services such as AppSecure features of AppID, AppFW, AppQoS, and AppTrack, IPS and rich routing capabilities.



- vSRX Virtual Firewall Premium-Next Generation Firewall with Anti-Virus Protection—Includes the features in the vSRX Virtual Firewall Next- Generation Firewall package, including the Content Security antivirus feature.

You deploy vSRX Virtual Firewall in an Amazon Virtual Private Cloud (Amazon VPC) as an application instance in the Amazon Elastic Compute Cloud (Amazon EC2). Each Amazon EC2 instance is deployed, accessed, and configured over the Internet using the AWS Management Console, and the number of instances can be scaled up or down as needed.

**NOTE:** In the current release, each vSRX Virtual Firewall instance uses two vCPUs and 4 GB of memory, even if the instance type selected on AWS provides more resources.

vSRX Virtual Firewall uses hardware assisted virtual machines (HVM) for high performance (enhanced networking), and supports the following deployments on AWS cloud environments:

- As a firewall between other Amazon EC2 instances on your Amazon VPC and the Internet
- As a VPN endpoint between your corporate network and your Amazon VPC
- As a firewall between Amazon EC2 instances on different subnets

There are default limits for AWS services for an AWS account. For more information about AWS service limits, see [https://docs.aws.amazon.com/general/latest/gr/aws\\_service\\_limits.html](https://docs.aws.amazon.com/general/latest/gr/aws_service_limits.html) and <https://docs.aws.amazon.com/AWSEC2/latest/UserGuide/using-eni.html>.

## AWS Glossary

This section defines some common terms used in an AWS configuration. [Table 63 on page 328](#) defines common terms used for Amazon Virtual Private Cloud (Amazon VPC) and [Table 64 on page 330](#) defines common terms for Amazon Elastic Compute Cloud (Amazon EC2) services.

**Table 63: Amazon VPC Related Terminology**

| Term              | Description                                                                                                |
|-------------------|------------------------------------------------------------------------------------------------------------|
| Internet gateways | Amazon VPC components that allow communications between your instances in the Amazon VPC and the Internet. |

Table 63: Amazon VPC Related Terminology (*Continued*)

| Term          | Description                                                                                                                                                                                                                                                                                                                                                                                                                                                                                                                                                                                                                                                                                                                                                                                                                                                                                                                                                                                                                                                                                                                                                                                                                                                                                                                                                                                                                                       |
|---------------|---------------------------------------------------------------------------------------------------------------------------------------------------------------------------------------------------------------------------------------------------------------------------------------------------------------------------------------------------------------------------------------------------------------------------------------------------------------------------------------------------------------------------------------------------------------------------------------------------------------------------------------------------------------------------------------------------------------------------------------------------------------------------------------------------------------------------------------------------------------------------------------------------------------------------------------------------------------------------------------------------------------------------------------------------------------------------------------------------------------------------------------------------------------------------------------------------------------------------------------------------------------------------------------------------------------------------------------------------------------------------------------------------------------------------------------------------|
| IP addressing | <p>AWS includes three types of IP address:</p> <ul style="list-style-type: none"> <li>• Public IP address—addresses obtained from a public subnet that is publicly routable from the Internet. Public IP addresses are mapped to primary private IP addresses through AWS NAT.</li> <li>• Private IP address—IP addresses in the Amazon VPC Classless Interdomain Routing (CIDR) range, as specified in RFC 1918, that are not publicly routable.</li> <li>• Elastic IP address—A static IP address designed for dynamic cloud computing. When an Elastic IP address is associated with a public IP network interface, the public IP address associated is released until the Elastic IP address is disassociated from the network interface.</li> </ul> <p>Each network interface can be associated with multiple private IP addresses. Public subnets can have multiple private IP addresses, public addresses, and Elastic IP addresses associated with the private IP address of the network interface. Instances in private and public subnets can have multiple private IP addresses. One Elastic IP address can be associated with each private IP address for instances in public subnets.</p> <p>You can assign static private IP addresses in the subnet. The first five IP addresses and the last IP address in the subnet are reserved for Amazon VPC networking and routing. The first IP address is the gateway for the subnet.</p> |
| Network ACL   | AWS stateless virtual firewall operating at the subnet level.                                                                                                                                                                                                                                                                                                                                                                                                                                                                                                                                                                                                                                                                                                                                                                                                                                                                                                                                                                                                                                                                                                                                                                                                                                                                                                                                                                                     |
| Route tables  | <p>A set of routing rules used to determine where the network traffic is directed. Each subnet needs to be associated with a route table. Subnets not explicitly associated with a route table are associated with the main route table.</p> <p>Custom route tables can be created other than the default table.</p>                                                                                                                                                                                                                                                                                                                                                                                                                                                                                                                                                                                                                                                                                                                                                                                                                                                                                                                                                                                                                                                                                                                              |

**Table 63: Amazon VPC Related Terminology (Continued)**

| Term   | Description                                                                                                                                                                                                                                                                                                                                                                                                                                                                                                                                                                                                                                                                                                                                          |
|--------|------------------------------------------------------------------------------------------------------------------------------------------------------------------------------------------------------------------------------------------------------------------------------------------------------------------------------------------------------------------------------------------------------------------------------------------------------------------------------------------------------------------------------------------------------------------------------------------------------------------------------------------------------------------------------------------------------------------------------------------------------|
| Subnet | <p>A virtual addressing space in the Amazon VPC CIDR block. The IP addresses for the Amazon EC2 instances are allocated from the subnet pool of IP addresses.</p> <p>You can create two types of subnets in the Amazon VPC:</p> <ul style="list-style-type: none"> <li>• Public subnets-Subnets that have traffic connections to the Internet gateway.</li> <li>• Private subnets-Subnets that do not have connections to the Internet gateway</li> </ul> <p><b>NOTE:</b> With vSRX Virtual Firewall Network Address Translation (NAT), you can launch all customer instances in private subnets and connect vSRX Virtual Firewall interfaces to the Internet. This protects customer instances from being directly exposed to Internet traffic.</p> |
| VPC    | Virtual private cloud.                                                                                                                                                                                                                                                                                                                                                                                                                                                                                                                                                                                                                                                                                                                               |

**Table 64: Amazon EC2 Related Terminology**

| Term                               | Description                                                                                                                                                                                                                                |
|------------------------------------|--------------------------------------------------------------------------------------------------------------------------------------------------------------------------------------------------------------------------------------------|
| Amazon Elastic Block Store (EBS)   | Persistent block storage that can be attached to an Amazon EC2 instance. Block storage volumes can be formatted and mounted on an instance. Amazon EBS optimized instances provide dedicated throughput between Amazon EC2 and Amazon EBS. |
| Amazon Elastic Compute Cloud (EC2) | Amazon Web service that enables launch and management of elastic virtual servers or computers that run on the Amazon infrastructure.                                                                                                       |
| Amazon Machine Image (AMI)         | Amazon image format that contains the information, such as the template for root volume, launch permissions, and block device mapping, that is required to launch an Amazon EC2 instance.                                                  |
| Elastic IP                         | A static IP designed for dynamic cloud computing. The public IP is mapped to the private subnet IP using NAT.                                                                                                                              |

Table 64: Amazon EC2 Related Terminology (Continued)

| Term                | Description                                                                                                                                                                                                                                                                                                                                                                                                                                                                                                                                                                         |
|---------------------|-------------------------------------------------------------------------------------------------------------------------------------------------------------------------------------------------------------------------------------------------------------------------------------------------------------------------------------------------------------------------------------------------------------------------------------------------------------------------------------------------------------------------------------------------------------------------------------|
| Enhanced networking | Provides high packet per second performance, low latency, higher I/O performance, and lower CPU utilization compared to traditional implementations. vSRX Virtual Firewall leverages this networking with hardware virtualized machine (HVM) Amazon Machine Images (AMIs).                                                                                                                                                                                                                                                                                                          |
| Instance            | A virtual machine or server on Amazon EC2 that uses XEN or, XEN-HVM hypervisor types. Amazon EC2 provides a selection of instances optimized for different use cases.                                                                                                                                                                                                                                                                                                                                                                                                               |
| Keypair             | <p>Public key cryptography used by AWS to encrypt and decrypt login information. Create these keypairs using AWS-EC2 or import your own keypair.</p> <p><b>NOTE:</b> AWS does not accept DSA. Limit the public key access permissions to 400.</p> <p>For more information about key rotation, see <a href="https://docs.aws.amazon.com/kms/latest/developerguide/rotate-keys.html">https://docs.aws.amazon.com/kms/latest/developerguide/rotate-keys.html</a>.</p>                                                                                                                  |
| Network interfaces  | <p>Virtual network interfaces that you can attach to an instance in the Amazon VPC. An Elastic Network Interface (ENI) can have a primary private IP address, multiple secondary IP addresses, one Elastic IP address per private IP address, one public IP address, one or more security groups, one MAC address, and a source/destination check flag.</p> <p>For vSRX Virtual Firewall instances, disable the source/destination check for all interfaces.</p> <p><b>NOTE:</b> ENIs use the IP addresses within the subnet range. So, the ENI IP addresses are not exhausted.</p> |
| Network MTU         | <p>All Amazon instance types support an MTU of 1500. Some instance types support jumbo frames (9001 MTU).</p> <p><b>NOTE:</b> Use C3, C4, C5, CC2, M3, M4, or T2 AWS instance types for vSRX Virtual Firewall instances with jumbo frames.</p>                                                                                                                                                                                                                                                                                                                                      |
| Placement Groups    | Instances launched in a common cluster placement group. Instances within the cluster have networks with high bandwidth and low latency.                                                                                                                                                                                                                                                                                                                                                                                                                                             |

**Table 64: Amazon EC2 Related Terminology (Continued)**

| Term            | Description                                                                                                                                                                                                                                                                                                                                                                                                       |
|-----------------|-------------------------------------------------------------------------------------------------------------------------------------------------------------------------------------------------------------------------------------------------------------------------------------------------------------------------------------------------------------------------------------------------------------------|
| Security groups | <p>An AWS-provided virtual firewall that controls the traffic for one or more instances. Security groups can be associated with an instance only at launch time.</p> <p><b>NOTE:</b> Because vSRX Virtual Firewall manages your firewall settings, we recommend that you ensure there is no contradiction between rule sets on AWS security groups and rule sets in your vSRX Virtual Firewall configuration.</p> |

**Release History Table**

| Release     | Description                                                                                                                                                                     |
|-------------|---------------------------------------------------------------------------------------------------------------------------------------------------------------------------------|
| 15.1X49-D70 | Starting in Junos OS Release 15.1X49-D70 and Junos OS Release 17.3R1, vSRX Virtual Firewall supports two bundles for PAYG that are available as 1-hour or 1-year subscriptions. |

**RELATED DOCUMENTATION**

[AWS Tutorials](#)

[Getting Started with AWS](#)

**Requirements for vSRX Virtual Firewall on AWS****IN THIS SECTION**

- [Minimum System Requirements for AWS | 333](#)
- [Interface Mapping for vSRX Virtual Firewall on AWS | 333](#)
- [vSRX Virtual Firewall Default Settings on AWS | 335](#)
- [Best Practices for Improving vSRX Virtual Firewall Performance | 336](#)

This section presents an overview of requirements for deploying a vSRX Virtual Firewall instance on Amazon Web Services (AWS).

## Minimum System Requirements for AWS

Table 65 on page 333 lists the minimum system requirements for vSRX Virtual Firewall instances to be deployed on AWS.

in

**Table 65: Minimum System Requirements for vSRX Virtual Firewall**

| Component          | Specification and Details                                                                                                                                              |
|--------------------|------------------------------------------------------------------------------------------------------------------------------------------------------------------------|
| Hypervisor support | XEN-HVM                                                                                                                                                                |
| Memory             | 4 GB                                                                                                                                                                   |
| Disk space         | 16 GB                                                                                                                                                                  |
| vCPUs              | 2                                                                                                                                                                      |
| vNICs              | 3                                                                                                                                                                      |
| vNIC type          | SR-IOV                                                                                                                                                                 |
| AMD Processors     | Starting in Junos OS Release 22.3R2, vSRX Virtual Firewall 3.0 on Amazon Web Services (AWS) support the Advanced Micro Devices (AMD) processor for better performance. |

## Interface Mapping for vSRX Virtual Firewall on AWS

vSRX Virtual Firewall on AWS supports up to a maximum of eight network interfaces, but the actual maximum number of interfaces that can be attached to a vSRX Virtual Firewall instance is dictated by the AWS instance type in which it is launched. For AWS instances that allow more than eight interfaces, vSRX Virtual Firewall will support up to a maximum of eight interfaces only.

The following are the supported C5 instance types :

- c5.large
- c5.xlarge
- c5.2xlarge

- c5.4xlarge
- c5.9xlarge
- c5n.2xlarge
- c5n.4xlarge
- c5n.9xlarge

The following are the supported AMD-based AWS instances:

- C5a.16xlarge
- C5a.8xlarge
- C5a.4xlarge
- C5a.2xlarge
- C5a.xlarge

For more information on instance details such as vCPUs, memory and so on, see [Pricing Information](#)

For more information on maximum network interfaces by instance type, see <https://docs.aws.amazon.com/AWSEC2/latest/UserGuide/using-eni.html> .

[Table 66 on page 334](#) shows a mapping between vSRX Virtual Firewall interface names and their corresponding AWS interface names for up to eight network interfaces. The first network interface is used for the out-of-band management (fxp0) for vSRX Virtual Firewall.

**Table 66: vSRX Virtual Firewall and AWS Interface Names**

| Interface Number | vSRX Virtual Firewall Interface | AWS Interface |
|------------------|---------------------------------|---------------|
| 1                | fxp0                            | eth0          |
| 2                | ge-0/0/0                        | eth1          |
| 3                | ge-0/0/1                        | eth2          |
| 4                | ge-0/0/2                        | eth3          |

**Table 66: vSRX Virtual Firewall and AWS Interface Names (Continued)**

| Interface Number | vSRX Virtual Firewall Interface | AWS Interface |
|------------------|---------------------------------|---------------|
| 5                | ge-0/0/3                        | eth4          |
| 6                | ge-0/0/4                        | eth5          |
| 7                | ge-0/0/5                        | eth6          |
| 8                | ge-0/0/6                        | eth7          |

We recommend putting revenue interfaces in routing instances as a best practice to avoid asymmetric routing. Since fxp0 is part of the default (inet.0) routing table, there might be two default routes needed in the same routing instance: one for the fxp0 interface for external management access, and the other for the revenue interfaces for traffic access, resulting in asymmetric routing. Putting the revenue interfaces in a separate routing instance avoids this situation of two default routes in a single routing instance.

**NOTE:** Ensure that interfaces belonging to the same security zone are in the same routing instance. See [KB Article - Interface must be in the same routing instance as the other interfaces in the zone.](#)

## vSRX Virtual Firewall Default Settings on AWS

vSRX Virtual Firewall requires the following basic configuration settings:

- Interfaces must be assigned IP addresses.
- Interfaces must be bound to zones.
- Policies must be configured between zones to permit or deny traffic.
- The ENA driver-related component must be ready for vSRX Virtual Firewall.

[Table 67 on page 336](#) lists the factory-default settings for security policies on the vSRX Virtual Firewall.



**Table 67: Factory-Default Settings for Security Policies**

| Source Zone | Destination Zone | Policy Action |
|-------------|------------------|---------------|
| trust       | untrust          | permit        |
| trust       | trust            | permit        |



**CAUTION:** Do not use the `load factory-default` command on a vSRX Virtual Firewall AWS instance. The factory-default configuration removes the AWS preconfiguration. If you must revert to factory default, ensure that you manually reconfigure AWS preconfiguration statements before you commit the configuration; otherwise, you will lose access to the vSRX Virtual Firewall instance. See *Configure vSRX Using the CLI* for AWS preconfiguration details.

## Best Practices for Improving vSRX Virtual Firewall Performance

Review the following deployment practices to improve vSRX Virtual Firewall performance:

- Disable the source/destination check for all vSRX Virtual Firewall interfaces.
- Limit public key access permissions to 400 for key pairs.
- Ensure that there are no contradictions between AWS security groups and your vSRX Virtual Firewall configuration.
- Use the c5n instance types on AWS for best throughput on the vSRX Virtual Firewall.

**NOTE:** For c5-large instances, AWS uses second generation Intel Xeon Scalable Processors (Cascade Lake) or first generation Intel Xeon Platinum 8000 series (Skylake-SP) processor and for c4-xtra large instances, AWS uses high frequency Intel Xeon E5-2666 v3.

- Ensure traffic flows through multiple interfaces of the vSRX Virtual Firewall for optimal usage of the vCPUs.
- Use vSRX Virtual Firewall NAT to protect your Amazon EC2 instances from direct Internet traffic.

# Configure and Manage Virtual Firewall in AWS

## IN THIS CHAPTER

- [Configure an Amazon Virtual Private Cloud for vSRX Virtual Firewall | 337](#)
- [Launch a vSRX Virtual Firewall Instance on an Amazon Virtual Private Cloud | 348](#)
- [Enroll a vSRX Virtual Firewall on AWS with Juniper ATP Cloud | 359](#)
- [Using Cloud-Init to Automate the Initialization of vSRX Virtual Firewall Instances in AWS | 364](#)
- [AWS Elastic Load Balancing and Elastic Network Adapter | 366](#)
- [Multi-Core Scaling Support on AWS with SWRSS and ENA | 384](#)
- [Centralized Monitoring and Troubleshooting using AWS Features | 385](#)
- [Deploying vSRX Virtual Firewall 3.0 for Securing Data using AWS KMS | 398](#)
- [Configure vSRX Virtual Firewall Using the CLI | 406](#)
- [Configure vSRX Virtual Firewall Using the J-Web Interface | 411](#)
- [Upgrade Junos OS Software on a vSRX Virtual Firewall Instance | 414](#)
- [Remove a vSRX Virtual Firewall Instance on AWS | 416](#)
- [Geneve Flow Infrastructure on vSRX Virtual Firewall 3.0 | 416](#)
- [AWS Gateway Load Balancing with Geneve | 433](#)

## Configure an Amazon Virtual Private Cloud for vSRX Virtual Firewall

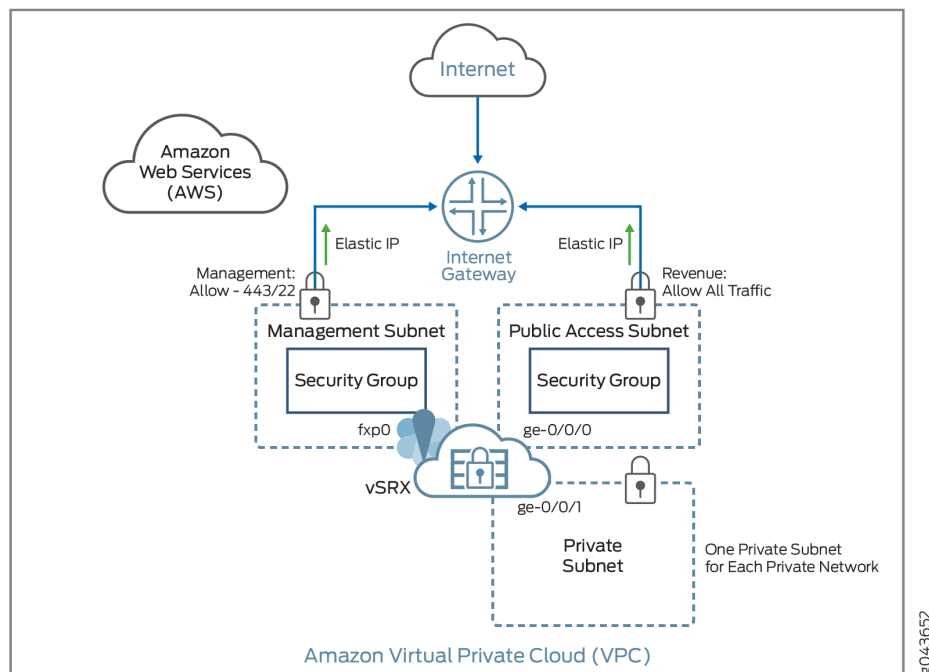
### IN THIS SECTION

- [Step 1: Create an Amazon VPC and Internet Gateway | 338](#)
- [Step 2: Add Subnets for vSRX Virtual Firewall | 340](#)
- [Step 3: Attach an interface to a Subnet | 341](#)
- [Step 4: Add Route Tables for vSRX Virtual Firewall | 344](#)
- [Step 5: Add Security Groups for vSRX Virtual Firewall | 345](#)

Before you begin, you need an Amazon Web Services (AWS) account and an Identity and Access Management (IAM) role, with all required permissions to access, create, modify, and delete Amazon Elastic Compute Cloud (Amazon EC2), Amazon Simple Storage Service (S3), and Amazon Virtual Private Cloud (Amazon VPC) objects. You should also create access keys and corresponding secret access keys, X.509 certificates, and account identifiers. For better understanding of AWS terminologies and their use in vSRX Virtual Firewall AWS deployments, see *Understand vSRX with AWS*.

Figure 87 on page 338 shows an example of how you can deploy vSRX Virtual Firewall to provide security for applications running in a private subnet of an Amazon VPC.

**Figure 87: Example of vSRX Virtual Firewall in AWS Deployment**

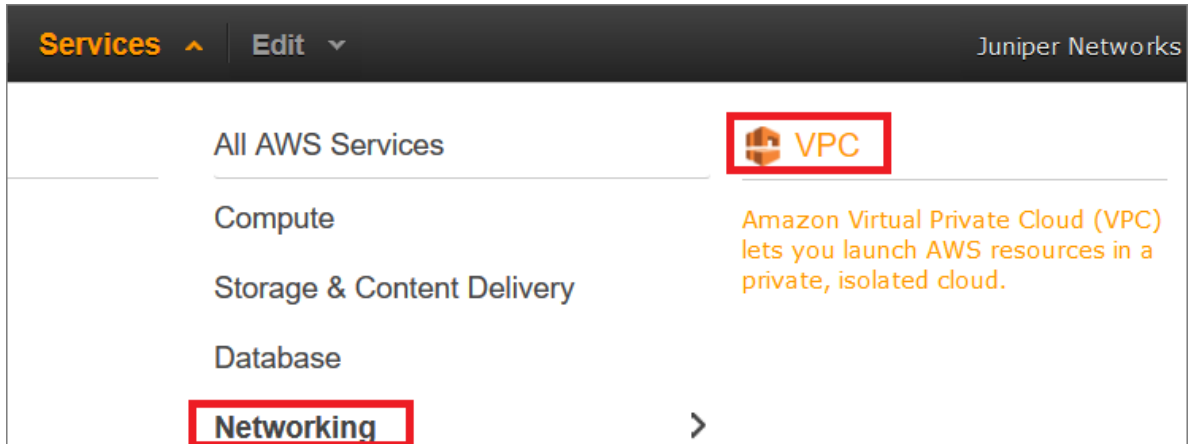


The following procedures outline how to create and prepare an Amazon VPC for vSRX Virtual Firewall. The procedures describe how to set up an Amazon VPC with its associated Internet gateway, subnets, route table, and security groups.

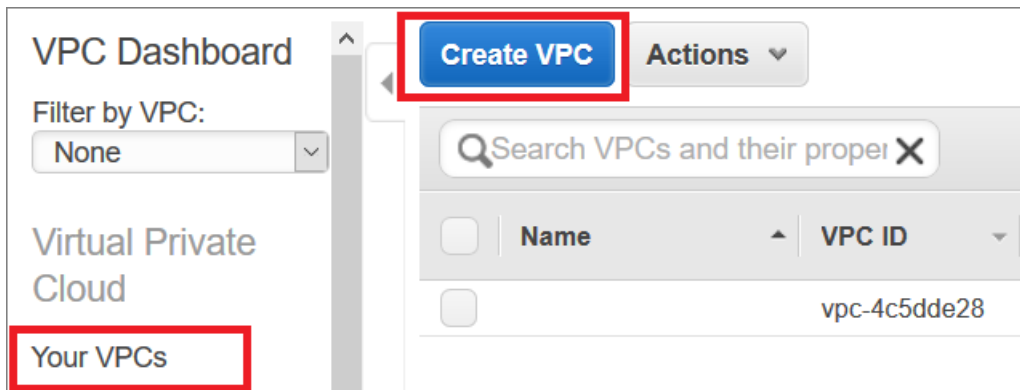
### Step 1: Create an Amazon VPC and Internet Gateway

Use the following procedure to create an Amazon VPC and an Internet gateway. If you have already have a VPC and an Internet gateway, go to "[Step 2: Add Subnets for vSRX Virtual Firewall](#)" on page 340.

1. Log in to the AWS Management Console and select **Services > Networking > VPC**.



2. In the VPC Dashboard, select **Your VPCs** in the left pane, and click **Create VPC**.



3. Specify a VPC name and a range of private IP addresses in Classless Interdomain Routing (CIDR) format. Leave Default as the Tenancy.

The screenshot shows the 'Create VPC' dialog box. The title is 'Create VPC' and there is a close button (X) in the top right corner. Below the title, there is a paragraph of text: 'A VPC is an isolated portion of the AWS cloud populated by AWS objects, such as Amazon EC2 instances. Use the Classless Inter-Domain Routing (CIDR) block format to specify your VPC's contiguous IP address range, for example, 10.0.0.0/16. You cannot create a VPC larger than /16.' Below the text, there are three input fields: 'Name tag' with the value 'ixVPC', 'CIDR block' with the value '10.0.0.0/16', and 'Tenancy' with the value 'Default'. Each input field has an information icon (i) to its right. At the bottom right of the dialog box, there are two buttons: 'Cancel' and 'Yes, Create'.

4. Click **Yes, Create**.
5. Select **Internet Gateways** in the left pane, and click **Create Internet Gateway**.



6. Specify a gateway name and click **Yes, Create**.
7. Select the gateway you just created and click **Attach to VPC**.
8. Select the new Amazon VPC, and click **Yes, Attach**.



## Step 2: Add Subnets for vSRX Virtual Firewall

In the Amazon VPC, public subnets have access to the Internet gateway, but private subnets do not. vSRX Virtual Firewall requires two public subnets and one or more private subnets for each individual instance group. The public subnets consist of one for the management interface (fxp0) and one for a revenue (data) interface. The private subnets, connected to the other vSRX Virtual Firewall interfaces, ensure that all traffic between applications on the private subnets and the Internet must pass through the vSRX Virtual Firewall instance.

To create each vSRX Virtual Firewall subnet:

1. In the VPC Dashboard, select **Subnets** in the left pane, and click **Create Subnet**.
2. Specify a subnet name, select the Amazon VPC and availability zone, and specify the range of subnet IP addresses in CIDR format.

**TIP:** As a naming convention best practice for subnets, we recommend including **private** or **public** in the name to make it easier to know which subnet is public or private.

**NOTE:** All subnets for a vSRX Virtual Firewall instance must be in the same availability zone. Do not use **No Preference** for the availability zone.

3. Click **Yes, Create**.

The screenshot shows the AWS VPC Dashboard with the 'Create Subnet' dialog box open. The left navigation pane has 'Subnets' highlighted with a red box. The dialog box contains the following information:

- Name tag:** ixmgm\_subnet\_254
- VPC:** vpc-eb602b8c (10.0.0.0/16) | ixVPC
- Availability Zone:** us-east-1a
- CIDR block:** 10.0.254.0/24

Buttons for 'Cancel' and 'Yes, Create' are visible at the bottom right of the dialog.

Repeat these steps for each subnet you want to create and attach to the vSRX Virtual Firewall instance.

### Step 3: Attach an interface to a Subnet

To attach an interface to a subnet:

1. Create a network interface from the Amazon EC2 home page.  
Click the Network Interface option on the EC2 home page and the **Create Network Interface** page opens.

| Name                   | Network interf. | Subnet ID       | VPC ID       | Zone       | Security groups        | Description            |
|------------------------|-----------------|-----------------|--------------|------------|------------------------|------------------------|
| muruganp-ni1-sp1       | eni-009f9905    | subnet-b47d12ef | vpc-7650d811 | us-west-1c | muruganp-sg            | muruganp-ni1-sp1       |
| skondi-ni-254-sn2-v... | eni-00acdb28    | subnet-3255b256 | vpc-9cb294f9 | us-west-1a | skondi-jnpr-vpc-10.... | skondi-ni-254-sn2-v... |
|                        | eni-01085e2e    | subnet-16390e72 | vpc-c251c8a6 | us-west-1a | skonwar-10.20-sg       |                        |

- Click the **Create Network Interface** option, fill in the required information in the fields, and then click **Create**.

**Create Network Interface**

Description:

Subnet\*:

IPv4 Private IP:  Auto-assign  Custom

Security groups\*:

| Group ID                                        | Group name | Description                |
|-------------------------------------------------|------------|----------------------------|
| <input checked="" type="checkbox"/> sg-082cb06f | ha1-to-ha2 | ha1-to-ha2                 |
| <input type="checkbox"/> sg-0cc75b6b            | ha2-local  | ha2-local                  |
| <input type="checkbox"/> sg-70eb7b17            | default    | default VPC security group |
| <input type="checkbox"/> sg-cefd61a9            | ha2-jnpr   | ha2-jnpr                   |

\* Required Cancel **Create**

- Find and select your newly created interface.

If this interface is the revenue interface, then select **Change Source/Dest.Check** from the **Action** menu, choose **Disabled**, and click **Save**. If this interface is your fxp0 interface then skip this disabling step.

The screenshot shows the AWS Management Console interface for network interfaces. At the top, there are buttons for 'Create Network Interface', 'Attach', 'Detach', 'Delete', and 'Actions'. Below these is a search bar and a table with columns: Name, Network interface ID, and Subnet ID. The table contains one entry: 'vsrx-ge000-untrust' with ID 'eni-01c2388a8e3a15cec' and Subnet ID 'subnet-0b6cb841'. A modal dialog box titled 'Change Source/Dest. Check' is open, showing the selected network interface ID and two radio buttons for 'Source/dest. check': 'Enabled' (unselected) and 'Disabled' (selected). At the bottom of the dialog are 'Cancel' and 'Save' buttons.

4. Click **Attach** from the menu on top of the screen, choose the **Instance ID** of your vSRX Virtual Firewall instance, and click **Attach**.

The screenshot shows the AWS Management Console interface for network interfaces. At the top, there are buttons for 'Create Network Interface', 'Attach', 'Detach', 'Delete', and 'Actions'. Below these is a search bar and a table with columns: Name, Network interface ID, Subnet ID, and VPC ID. The table contains five entries, with the last one selected: 'vsrx-ge000-untrust' with ID 'eni-01c2388a8e3a15cec', Subnet ID 'subnet-0b6cb841', and VPC ID 'vpc-f00c6b8b'. A modal dialog box titled 'Attach Network Interface' is open, showing the selected network interface ID and a dropdown menu for 'Instance ID' with the value 'i-041bb7c0f08ddf96b (stopped)'. At the bottom of the dialog are 'Cancel' and 'Attach' buttons.



5. vSRX Virtual Firewall does not support interface hot plug-in. So, when you are done adding the interfaces, reboot the vSRX Virtual Firewall instances on which the interfaces were added, to apply the changes to take effect.

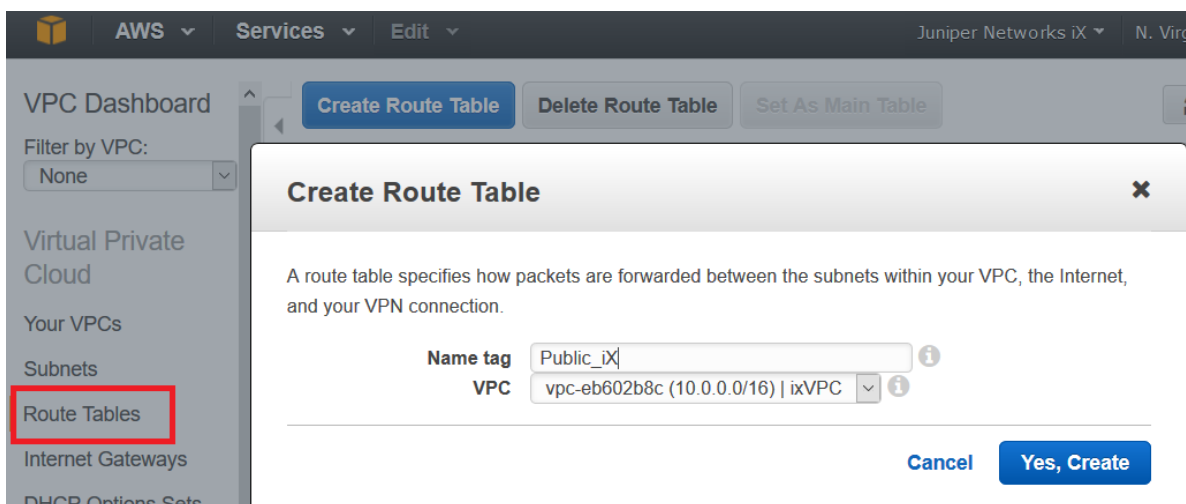
#### Step 4: Add Route Tables for vSRX Virtual Firewall

A main route table is created for each Amazon VPC by default. We recommend that you create a custom route table for the public subnets and a separate route table for each private subnet. All subnets that are not associated with a custom route table are associated with the main route table.

To create the route tables:

1. In the VPC Dashboard, select **Route Tables** in the left pane, and click **Create Route Table**.
2. Specify a route table name, select the VPC, and click **Yes, Create**.

**TIP:** As a naming convention best practice for route tables, we recommend including **private** or **public** in the name to make it easier to know which route table is public or private.



3. Repeat steps 1 and 2 to create all the route tables.
4. Select the route table you created for the public subnets and do the following:
  - a. Select the **Routes** tab below the list of route tables.
  - b. Click **Edit** and click **Add another route**.
  - c. Enter **0.0.0.0/0** as the destination, select your VPC internet gateway as the target, and click **Save**.

Public\_iX      rtb-02a60c64      0 Subnets      No      vpc-eb602b8c (10.0.0.0/16) | i

rtb-02a60c64 | Public\_iX

Summary    Routes    Subnet Associations    Route Propagation    Tags

Cancel    Save

| Destination | Target       | Status | Propagated | Remove |
|-------------|--------------|--------|------------|--------|
| 10.0.0.0/16 | local        | Active | No         |        |
| 0.0.0.0/0   | igw-bce1fad8 | No     |            | ✕      |

Add another route

- d. Select the **Subnet Associations** tab, and click **Edit**.
- e. Select the check boxes for the public subnets, and click **Save**.

Public\_iX      rtb-02a60c64      0 Subnets      No      vpc-eb602b8c (10

rtb-02a60c64 | Public\_iX

Summary    Routes    Subnet Associations    Route Propagation    Tags

Cancel    Save

| Associate                           | Subnet                                               | CIDR          | Current Route Table |
|-------------------------------------|------------------------------------------------------|---------------|---------------------|
| <input checked="" type="checkbox"/> | subnet-6cbd6025 (10.0.10.0/24)   ixpublic_subnet_10  | 10.0.10.0/24  | Main                |
| <input type="checkbox"/>            | subnet-19bd6050 (10.0.20.0/24)   ixPrivate_subnet_20 | 10.0.20.0/24  | Main                |
| <input checked="" type="checkbox"/> | subnet-b7825ffe (10.0.254.0/24)   ixmgm_subnet_254   | 10.0.254.0/24 | Main                |

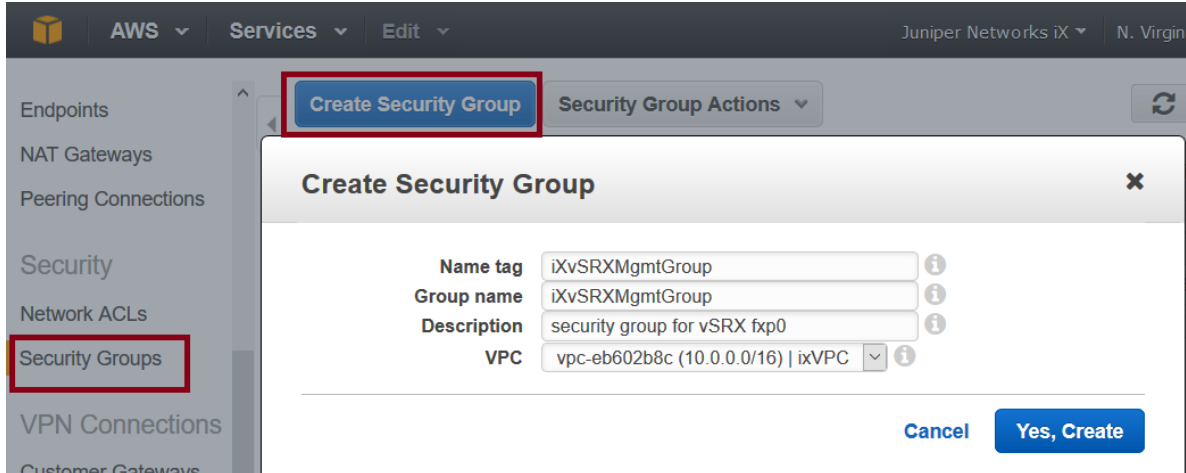
5. Select each route table you created for a private subnet and do the following:
  - a. Select the **Subnet Associations** tab, and click **Edit**.
  - b. Select the check box for one private subnet, and click **Save**.

## Step 5: Add Security Groups for vSRX Virtual Firewall

A default security group is created for each Amazon VPC. We recommend that you create a separate security group for the vSRX Virtual Firewall management interface (fxp0) and another security group for all other vSRX Virtual Firewall interfaces. The security groups are assigned when a vSRX Virtual Firewall instance is launched in the Amazon EC2 Dashboard, where you can also add and manage security groups.

To create the security groups:

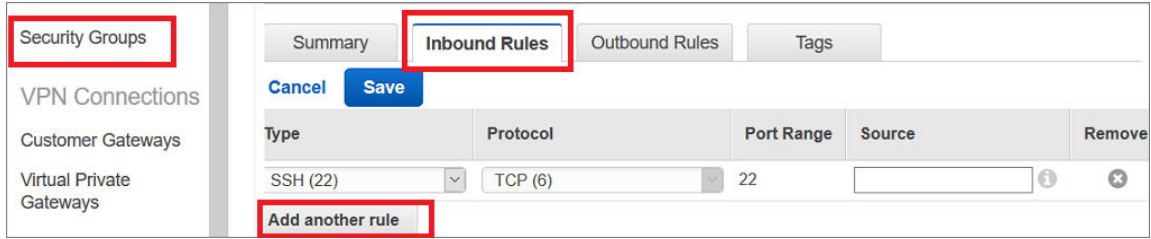
1. In the VPC Dashboard, select **Security Groups** in the left pane, and click **Create Security Group**.
2. For the vSRX Virtual Firewall management interface, specify a security group name in the Name Tag field, edit the Group Name field (optional), enter a description of the group, and select the VPC.
3. Click **Yes, Create**.



4. Repeat Steps 1 through 3 to create a security group for the vSRX Virtual Firewall revenue interfaces.
5. Select the security group you created for the management interface and do the following:
  - a. Select the **Inbound Rules** tab below the list of security groups.
  - b. Click **Edit** and click **Add another rule** to create the following inbound rules:

| Type            | Protocol | Port    | Source                                                                 |
|-----------------|----------|---------|------------------------------------------------------------------------|
| Custom TCP rule | Default  | 20-21   | Enter CIDR address format for each rule (0.0.0.0/0 allows any source). |
| SSH (22)        | Default  | Default |                                                                        |
| HTTP (80)       | Default  | Default |                                                                        |
| HTTPS (443)     | Default  | Default |                                                                        |

- c. Click **Save**.



- d. Select the **Outbound Rules** tab to view the default rule that allows all outbound traffic. Use the default rule unless you need to restrict the outbound traffic.
6. Select the security group you created for all other vSRX Virtual Firewall interfaces and do the following:

**NOTE:** The inbound and outbound rules should allow all traffic to avoid conflicts with the security settings on vSRX Virtual Firewall.

- a. Select the **Inbound Rules** tab below the list of security groups.
- b. Click **Edit** and create the following inbound rule:

| Type        | Protocol | Port | Source                                                                                                                                                                                                                        |
|-------------|----------|------|-------------------------------------------------------------------------------------------------------------------------------------------------------------------------------------------------------------------------------|
| All Traffic | All      | All  | <ul style="list-style-type: none"> <li>For webservers, enter 0.0.0.0/0</li> <li>For VPNs, enter a range of IPv4 addresses in the form of a Classless Inter-Domain Routing (CIDR) block (for example, 10.0.0.0/16).</li> </ul> |

- c. Click **Save**.
- d. Keep the default rule in the **Outbound Rules** tab. The default rule allows all outbound traffic.

## RELATED DOCUMENTATION

[Day One: Amazon Web Services with vSRX Cookbook](#)

[IAM Roles for Amazon EC2](#)

## Launch a vSRX Virtual Firewall Instance on an Amazon Virtual Private Cloud

### IN THIS SECTION

- Step 1: Create an SSH Key Pair | 348
- Step 2: Launch a vSRX Virtual Firewall Instance | 350
- Step 3: View the AWS System Logs | 354
- Step 4: Add Network Interfaces for vSRX Virtual Firewall | 354
- Step 5: Allocate Elastic IP Addresses | 356
- Step 6: Add the vSRX Virtual Firewall Private Interfaces to the Route Tables | 356
- Step 7: Reboot the vSRX Virtual Firewall Instance | 357
- Step 8: Log in to a vSRX Virtual Firewall Instance | 357

The following procedures describe how to launch and configure a vSRX Virtual Firewall instance in the Amazon Virtual Private Cloud (Amazon VPC):

### Step 1: Create an SSH Key Pair

An SSH key pair is required to remotely access a vSRX Virtual Firewall instance on AWS. You can create a new key pair in the Amazon EC2 Dashboard or import a key pair created by another tool.

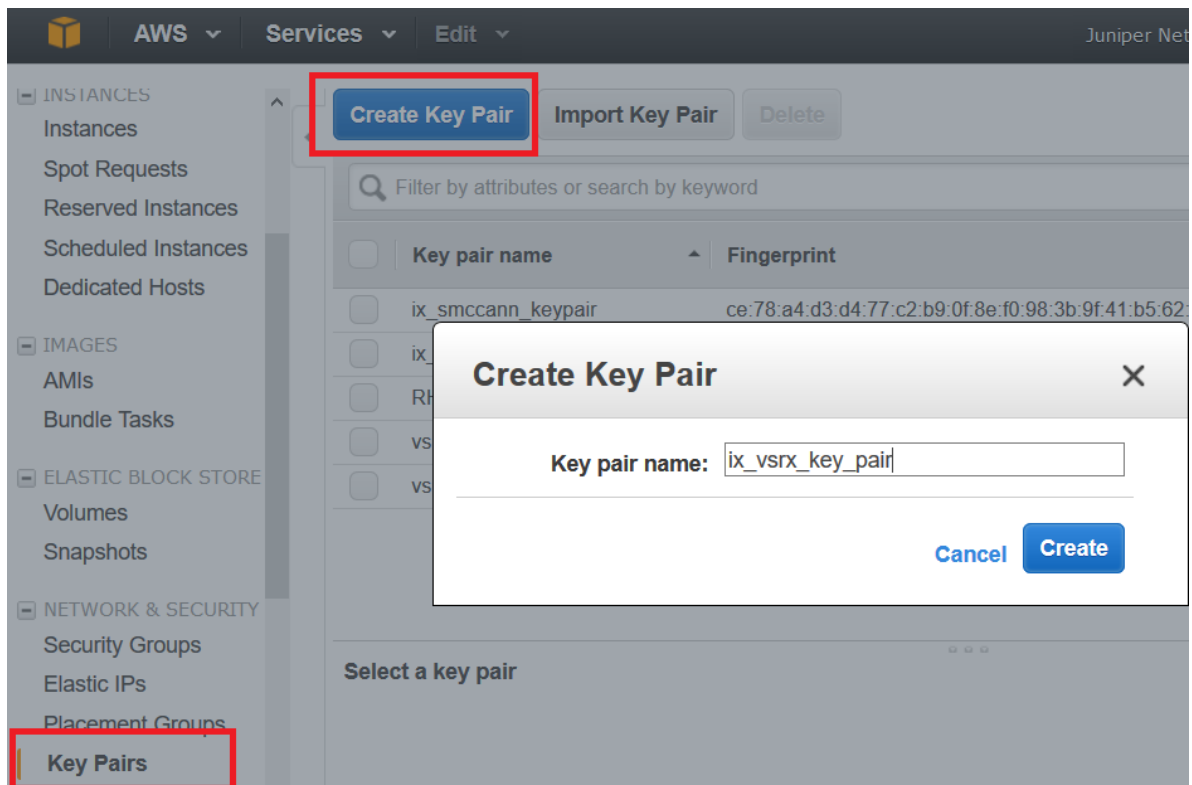
To create an SSH key pair:

1. Log in to the AWS Management Console and select **Services > Compute > EC2**.
2. In the Amazon EC2 Dashboard, select **Key Pairs** in the left pane. Verify that the region name shown in the toolbar is the same as the region where you created the Amazon Virtual Private Cloud (Amazon VPC).

Figure 88: Verify Region



3. Click **Create Key Pair**, specify a key pair name, and click **Create**.



4. The private key file (.pem) is automatically downloaded to your computer. Move the downloaded private key file to a secure location.
5. To use an SSH client on a Mac or Linux computer to connect to the vSRX Virtual Firewall instance, use the following command to set the permissions of the private key file so that only you can read it:

```
host# chmod 400 <key-pair-name>.pem
```

6. To access the vSRX Virtual Firewall instance from a shell prompt, use the `ssh -i <full path to your keyfile.pem>/<ssh-key-pair-name>.pem ec2-user@<public-ip-of-vsrx>` command. If the key file is in your

current directory, then you can use the file name instead of the full path as `ssh -i <keyfile.pem>/<ssh-key-pair-name>.pem ec2-user@<public-ip-of-vsrx>`.

**NOTE:** Alternately, use **Import Key Pair** to import a different key pair you generated with a third-party tool.

For more information on key rotation, see <https://docs.aws.amazon.com/kms/latest/developerguide/rotate-keys.html>.

## Step 2: Launch a vSRX Virtual Firewall Instance

The AWS instance types supported for vSRX Virtual Firewall are listed in [Table 68 on page 350](#).

vSRX Virtual Firewall does not support M and C3 instances types. If you have spun your vSRX Virtual Firewall using any of these instances types, then you must change the instance type to either C4 or C5 instances type.

**Table 68: Supported AWS Instance Types for vSRX Virtual Firewall**

| Instance Type | vSRX Virtual Firewall Type             | vCPUs | Memory (GB) | RSS Type |
|---------------|----------------------------------------|-------|-------------|----------|
| c5.large      | vSRX Virtual Firewall-2CPU-3G memory   | 2     | 4           | HW RSS   |
| c5.xlarge     | vSRX Virtual Firewall-4CPU-3G memory   | 4     | 8           | HW RSS   |
| c5.2xlarge    | vSRX Virtual Firewall-8CPU-15G memory  | 8     | 16          | HW RSS   |
| c5.4xlarge    | vSRX Virtual Firewall-16CPU-31G memory | 16    | 32          | SW RSS   |
| c5.9xlarge    | vSRX Virtual Firewall-36CPU-93G memory | 36    | 96          | SW RSS   |
| c5n.2xlarge   | vSRX Virtual Firewall-8CPU-20G memory  | 8     | 21          | HW RSS   |
| c5n.4xlarge   | vSRX Virtual Firewall-16CPU-41G memory | 16    | 42          | HW RSS   |
| c5n.9xlarge   | vSRX Virtual Firewall-36CPU-93G memory | 36    | 96          | HW RSS   |

vSRX Virtual Firewall on AWS supports up to a maximum of eight network interfaces, but the actual maximum number of interfaces that can be attached to a vSRX Virtual Firewall instance is dictated by the AWS instance type in which it is launched. For AWS instances that allow more than eight interfaces, vSRX Virtual Firewall will support up to a maximum of eight interfaces only.

The following are the supported C5 instance types :

- c5.large
- c5.xlarge
- c5.2xlarge
- c5.4xlarge
- c5.9xlarge
- c5n.2xlarge
- c5n.4xlarge
- c5n.9xlarge

For more information on instance details such as vCPUs, memory and so on, see [Pricing Information](#)

For more information on maximum network interfaces by instance type, see <https://docs.aws.amazon.com/AWSEC2/latest/UserGuide/using-eni.html> .

**BEST PRACTICE: Instance Type Selection**—Based on the changes that your require for your network, you might find that your instance is overutilized, (such as the instance type is too small) or underutilized, (such as the instance type is too large). If this is the case, you can change the size of your instance. For example, if your instance is too small for its workload, you can change it to another instance type that is appropriate for the workload. You might also want to migrate from a previous generation instance type to a current generation instance type to take advantage of some features; for example, support for IPv6. Consider change of instances for better performance and throughputs.

Starting with Junos OS Release 18.4R1, c5.large vSRX Virtual Firewall instances are supported. These are cost effective and provide better performance and throughput.

To launch a vSRX Virtual Firewall instance in the Amazon VPC:

1. Log in to your AWS account.
2. Navigate to **Amazon Market Place > Manage subscriptions**, and search for vSRX Virtual Firewall.
3. Select **vSRX Next Generation Firewall**.

The vSRX Virtual Firewall Next Generation Firewall Amazon Machine Image page appears.



4. Click **Launch New Instance**.
5. Select the delivery method, software version, and region for deployment. Click **Continue to launch through EC2**.
6. Select a supported instance type. See [Table 68 on page 350](#) for details.

1. Choose AMI   2. Choose Instance Type   3. Configure Instance   4. Add Storage   5. Tag Instance   6. Configure Security Group   7. Review

### Step 2: Choose an Instance Type

| <input type="checkbox"/>            | Instance Type     | Instance Size | vCPUs | Memory (GiB) | Storage  | EBS only | On-demand Capacity Block | Tenancy    |
|-------------------------------------|-------------------|---------------|-------|--------------|----------|----------|--------------------------|------------|
| <input checked="" type="checkbox"/> | Compute optimized | c4.large      | 2     | 3.75         | EBS only | Yes      |                          | Moderate   |
| <input checked="" type="checkbox"/> | Compute optimized | c4.xlarge     | 4     | 7.5          | EBS only | Yes      |                          | High       |
| <input type="checkbox"/>            | Compute optimized | c4.2xlarge    | 8     | 15           | EBS only | Yes      |                          | High       |
| <input type="checkbox"/>            | Compute optimized | c4.4xlarge    | 16    | 30           | EBS only | Yes      |                          | High       |
| <input checked="" type="checkbox"/> | Compute optimized | c4.8xlarge    | 36    | 60           | EBS only | Yes      |                          | 10 Gigabit |

Cancel   Previous   Review and Launch   Next: Configure Instance Details

7. Click **Next: Configure Instance Details**, and specify the fields in [Table 69 on page 352](#). Expand **Advanced Details** to see all settings.

**Table 69: AWS Instance Details**

| Field                                                                                                | Setting                                                                             |
|------------------------------------------------------------------------------------------------------|-------------------------------------------------------------------------------------|
| Network                                                                                              | Select the Amazon VPC configured for vSRX Virtual Firewall.                         |
| Subnet                                                                                               | Select the public subnet for the vSRX Virtual Firewall management interface (fxp0). |
| Auto-assign Public IP                                                                                | Select <b>Disable</b> (you will assign an Elastic IP address later).                |
| Placement group                                                                                      | Use the default.                                                                    |
| Shutdown behavior                                                                                    | Select <b>Stop</b> (the default).                                                   |
| <ul style="list-style-type: none"> <li>• Enable terminal protection</li> <li>• Monitoring</li> </ul> | Use your IT policy.                                                                 |
| Network Interfaces                                                                                   | Use the default or assign a public IP address for the <b>Primary IP</b> field.      |

Table 69: AWS Instance Details (Continued)

| Field     | Setting                                                                                                                                                                                                                                                                                                                                                                                                                                                                                                                                                                                                                                                                                                                                                                                                                                                                                                                             |
|-----------|-------------------------------------------------------------------------------------------------------------------------------------------------------------------------------------------------------------------------------------------------------------------------------------------------------------------------------------------------------------------------------------------------------------------------------------------------------------------------------------------------------------------------------------------------------------------------------------------------------------------------------------------------------------------------------------------------------------------------------------------------------------------------------------------------------------------------------------------------------------------------------------------------------------------------------------|
| User data | <p>Starting in Junos OS Release 17.4R1, the cloud-init package (version 0.7x) comes pre-installed in the vSRX Virtual Firewall for AWS image to help simplify configuring new vSRX Virtual Firewall instances operating on AWS according to a specified user-data file.</p> <p>In the User data section on the Configure Instance Details page, select <b>As File</b> and attach the user-data file. The selected file is used for the initial launch of the instance. During the initial boot-up sequence, the vSRX Virtual Firewall instance processes the cloud-init request. See <i>Using Cloud-Init to Automate the Initialization of vSRX Instances in AWS</i> for information about how to create the user-data file.</p> <p><b>NOTE:</b> The Junos OS configuration that is passed as user data is only imported at initial launch. If the instance is stopped and restarted, the user-data file is not imported again.</p> |

8. Click **Next: Add Storage**, and use the default settings or change the Volume Type and IOPS as needed.
9. Click **Next: Tag Instance**, and specify a name for the vSRX Virtual Firewall instance.
10. Click **Next: Configure Security Group**, select **Select an existing security group**, and select the security group created for the vSRX Virtual Firewall management interface (fxp0).
11. Click **Review and Launch**, review the settings for the vSRX Virtual Firewall instance, and click **Launch**.

Step 7: Review Instance Launch

sg-874ddefd    iXvSRXMgrmtGroup    security group for vSRX fxp0

All selected security groups inbound rules

| Security Group ID | Type            | Protocol | Port Range | Source |
|-------------------|-----------------|----------|------------|--------|
| sg-               | HTTP            | TCP      | 80         |        |
| sg-               | SSH             | TCP      | 22         |        |
| sg-               | Custom TCP Rule | TCP      | 20 - 21    |        |
| sg-               | HTTPS           | TCP      | 443        |        |

▼ Instance Details [Edit instance details](#)

Number of instances: 1    Purchasing option: On demand

Network: vpc-e  
Subnet: subnet-b78

EBS-optimized: Yes

Monitoring: No

Termination protection: No

Shutdown behavior: Stop

IAM role: None

Tenancy: default

Host ID

Affinity: Off

Kernel ID: Use default

RAM disk ID: Use default

User data

Assign Public IP: Use subnet setting (Disable)

Network interfaces

| Device | Network Interface     | Subnet     | Primary IP  | Secondary IP Addresses |
|--------|-----------------------|------------|-------------|------------------------|
| eth0   | New network interface | subnet-b78 | Auto-assign |                        |

▶ Storage [Edit storage](#)

▶ Tags [Edit tags](#)

Cancel Previous **Launch**

12. Select the SSH key pair you created, select the acknowledgment check box, and click **Launch Instance**.
13. Click **View Instances** to display the Instances list in the Amazon EC2 Dashboard. It might take several minutes to launch a vSRX Virtual Firewall instance.

### Step 3: View the AWS System Logs

To debug launch time errors, you can view the AWS system logs, as follows:

1. In the Amazon EC2 Dashboard, select **Instances**.
2. Select the vSRX Virtual Firewall instance, and select **Actions > Instance Settings > Get System Logs**.

### Step 4: Add Network Interfaces for vSRX Virtual Firewall

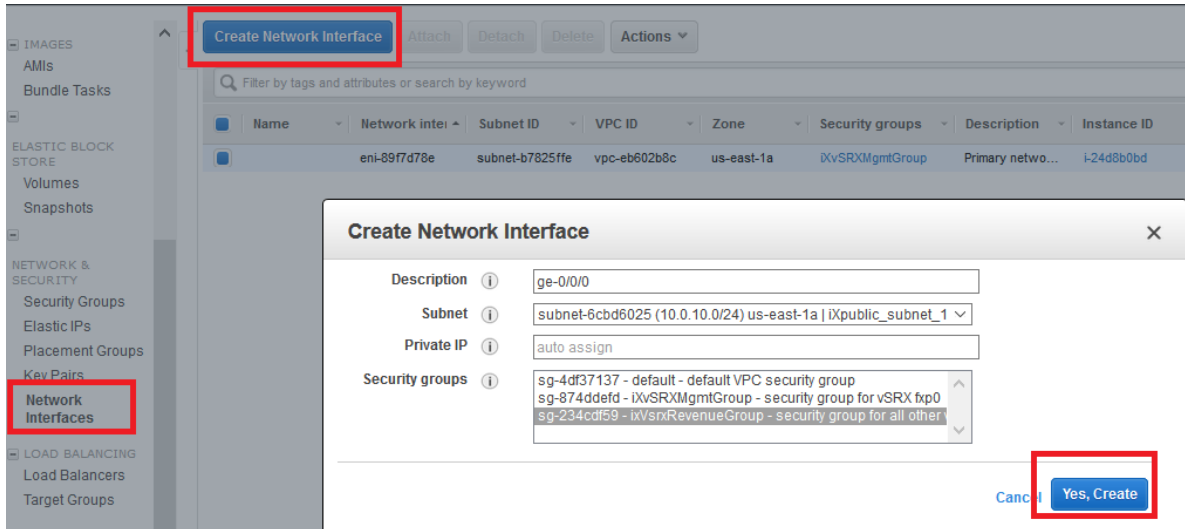
AWS supports up to eight interfaces for an instance, depending on the AWS instance type selected. Use the following procedure for each of the revenue interfaces you want to add to vSRX Virtual Firewall (up to seven). The first revenue interface is ge-0/0/0, the second is ge-0/0/1, and so on (see *Requirements for vSRX on AWS*).

To add a vSRX Virtual Firewall revenue interface:

1. In the Amazon EC2 Dashboard, select **Network Interfaces** in the left pane, and click **Create Network Interface**.
2. Specify the interface settings as shown in [Table 70 on page 354](#), and click **Yes, Create**.

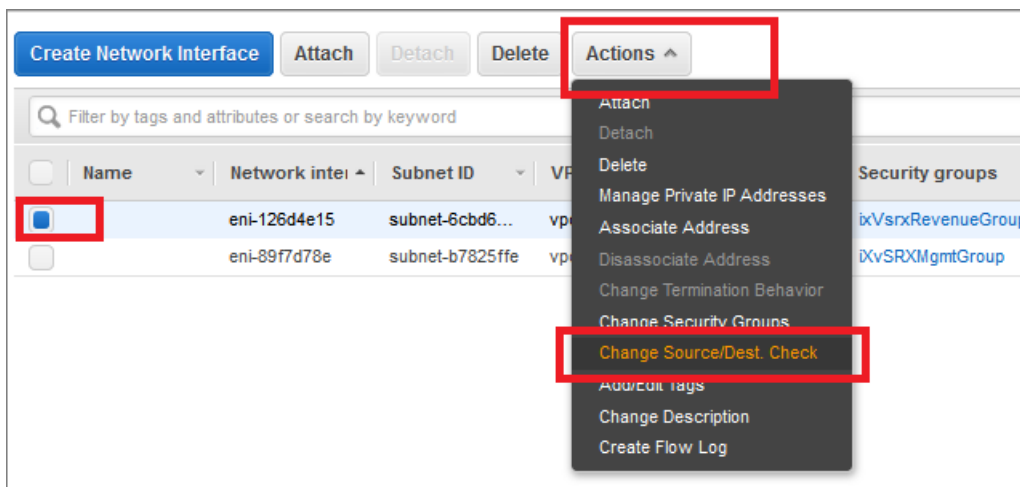
**Table 70: Network Interface Settings**

| Field           | Setting                                                                                                                                         |
|-----------------|-------------------------------------------------------------------------------------------------------------------------------------------------|
| Description     | Enter an interface description for each of the revenue interfaces.                                                                              |
| Subnet          | Select the public subnet created for the first revenue interface (ge-0/0/0) or the private subnet created for all the other revenue interfaces. |
| Private IP      | Enter an IP address from the selected subnet or allow the address to be assigned automatically.                                                 |
| Security Groups | Select the security group created for the vSRX Virtual Firewall revenue interfaces.                                                             |



3. Select the new interface, select **Actions > Change Source/Dest. Check**, select **Disabled**, and click **Save**.

Figure 89: Disable Source/Dest. Check



4. Select the new interface, select **Attach**, select the vSRX Virtual Firewall instance, and click **Attach**.
5. Click the pencil icon in the new interface Name column and give the interface a name (for example, ix-fxp0.0).

**NOTE:** For a private revenue interface (ge-0/0/1 through ge-0/0/7), make a note of the network name you created or the network interface ID. You will add the name or interface ID later to the route table created for the private subnet.

## Step 5: Allocate Elastic IP Addresses

For public interfaces, AWS does a NAT translation of the public IP address to a private IP address. The public IP address is called an *Elastic IP address*. We recommend that you assign an Elastic IP address to the public vSRX Virtual Firewall interfaces (fxp0 and ge-0/0/0). Note that when a vSRX Virtual Firewall instance is restarted, the Elastic IPs are retained, but public subnet IPs are released.

To create and allocate Elastic IPs:

1. In the Amazon EC2 Dashboard, select **Elastic IPs** in the left pane, click **Allocate New Address**, and click **Yes, Allocate**. (If your account supports EC2-Classical, you must first select **EC2-VPC** from the Network platform list.)
2. Select the new Elastic IP address, and select **Actions > Associate Address**.
3. Specify the settings in [Table 71 on page 356](#), and click **Allocate**.

**Table 71: Elastic IP Settings**

| Field              | Setting                                                                                                 |
|--------------------|---------------------------------------------------------------------------------------------------------|
| Network Interface  | Select the vSRX Virtual Firewall management interface (fxp0) or the first revenue interface (ge-0/0/0). |
| Private IP Address | Enter the private IP address to be associated with the Elastic IP address.                              |

## Step 6: Add the vSRX Virtual Firewall Private Interfaces to the Route Tables

For each private revenue interface you created for vSRX Virtual Firewall, you must add the interface ID to the route table you created for the associated private subnet.

To add a private interface ID to a route table:

1. In the VPC Dashboard, select **Route Tables** in the left pane.
2. Select the route table you created for the private subnet.
3. Select the **Routes** tab below the list of route tables.
4. Click **Edit** and click **Add another route**.
5. Specify the settings in [Table 72 on page 357](#), and click **Save**.

**Table 72: Private Route Settings**

| Field       | Setting                                                                                                                                                                                                                                                      |
|-------------|--------------------------------------------------------------------------------------------------------------------------------------------------------------------------------------------------------------------------------------------------------------|
| Destination | Enter 0.0.0.0/0 for Internet traffic.                                                                                                                                                                                                                        |
| Target      | Type the network name or the network interface ID for the associated private subnet. The network interface must be in the private subnet shown in the <b>Subnet Associations</b> tab.<br><br><b>NOTE:</b> Do not select the Internet gateway (igw-nnnnnnnn). |

Repeat this procedure for each private network interface. You must reboot the vSRX Virtual Firewall instance to complete this configuration.

### Step 7: Reboot the vSRX Virtual Firewall Instance

To incorporate the interface changes and complete the Amazon EC2 configuration, you must reboot the vSRX Virtual Firewall instance. Interfaces attached while the vSRX Virtual Firewall instance is running do not take effect until the instance is rebooted.

**NOTE:** Always use AWS to reboot the vSRX Virtual Firewall instance. Do not use the vSRX Virtual Firewall CLI to reboot.

To reboot a vSRX Virtual Firewall instance:

1. In the Amazon EC2 Dashboard, select **Instances** in the left pane.
2. Select the vSRX Virtual Firewall instance, and select **Actions > Instance State > Reboot**.

It might take several minutes to reboot a vSRX Virtual Firewall instance.

### Step 8: Log in to a vSRX Virtual Firewall Instance

In AWS deployments, vSRX Virtual Firewall instances provide the following capabilities by default to enhance security:

- Allows you to login only through SSH.
- cloud-init is used to setup SSH key login.
- SSH password login is disabled for root account.

vSRX Virtual Firewall instances launched on Amazon's AWS cloud infrastructure uses the cloud-init services provided by Amazon to copy the SSH public-key associated with your account that is used to launch the instance. You will then be able to login to the instance using the corresponding private-key.

**NOTE:** Root login using SSH password is disabled by default.

Use an SSH client to log in to a vSRX Virtual Firewall instance for the first time. To log in, specify the location where you saved the SSH key pair **.pem** file for the user account, and the Elastic IP address assigned to the vSRX Virtual Firewall management interface (fxp0).

**NOTE:** Starting in Junos OS Release 17.4R1, the default user name has changed from `root@` to `ec2-user@`.

```
ssh -i <path>/<ssh-key-pair-name>.pem ec2-user@<fxpo-elastic-IP-address>
```

**NOTE:** Root login using a Junos OS password is disabled by default. You can configure other users after the initial Junos OS setup phase.

If you do not have the key pair filename and Elastic IP address, use these steps to view the key pair name and Elastic IP for a vSRX Virtual Firewall instance:

1. In the Amazon EC2 Dashboard, select **Instances**.
2. Select the vSRX Virtual Firewall instance, and select **eth0** in the Description tab to view the Elastic IP address for the fxp0 management interface.
3. Click **Connect** above the list of instances to view the SSH key pair filename.

To configure the basic settings for the vSRX Virtual Firewall instance, see *Configure vSRX Using the CLI*.

**NOTE:** vSRX Virtual Firewall pay-as-you-go images do not require any separate licenses.

## Release History Table

| Release | Description                                                                                                                                                                                                                                                          |
|---------|----------------------------------------------------------------------------------------------------------------------------------------------------------------------------------------------------------------------------------------------------------------------|
| 17.4R1  | Starting in Junos OS Release 17.4R1, the cloud-init package (version 0.7x) comes pre-installed in the vSRX Virtual Firewall for AWS image to help simplify configuring new vSRX Virtual Firewall instances operating on AWS according to a specified user-data file. |

## RELATED DOCUMENTATION

[Day One: Amazon Web Services with vSRX Cookbook](#)

## Enroll a vSRX Virtual Firewall on AWS with Juniper ATP Cloud

Juniper ATP Cloud uses a Junos OS operation (op) script to help you configure your vSRX Virtual Firewall to connect to the Juniper Advanced Threat Prevention Cloud (ATP Cloud) service. This script performs the following tasks:

- Downloads and installs certificate authority (CAs) licenses onto your vSRX Virtual Firewall.
- Creates local certificates and enrolls them with the cloud server.
- Performs basic Juniper ATP Cloud configuration on the vSRX Virtual Firewall.
- Establishes a secure connection to the cloud server.

To enroll a vSRX Virtual Firewall in Juniper ATP Cloud using the ATP Cloud Web Portal, do the following:

1. Open a Web browser, type your customer portal URL and press **Enter**.

The Web UI login page appears as shown in [Figure 90 on page 360](#). See [Table 73 on page 359](#) for the customer portal hostname by location.

**Table 73: Customer Portal URL**

| Location       | Customer Portal URL                                                                                          |
|----------------|--------------------------------------------------------------------------------------------------------------|
| United States  | Customer Portal: <a href="https://amer.sky.junipersecurity.net">https://amer.sky.junipersecurity.net</a>     |
| European Union | Customer Portal: <a href="https://euapac.sky.junipersecurity.net">https://euapac.sky.junipersecurity.net</a> |



**Table 73: Customer Portal URL (Continued)**

| Location | Customer Portal URL                                                                                          |
|----------|--------------------------------------------------------------------------------------------------------------|
| APAC     | Customer Portal: <a href="https://apac.sky.junipersecurity.net">https://apac.sky.junipersecurity.net</a>     |
| Canada   | Customer Portal: <a href="https://canada.sky.junipersecurity.net">https://canada.sky.junipersecurity.net</a> |

**Figure 90: Juniper ATP Cloud Web UI Login Page**

**ATP Cloud**  
Login

Realm

E-mail Address   Remember me

Password

[Create a Security Realm](#)  
[Forgot Password](#)  
[Forgot Realm](#)

[Supported JUNOS Software and Documentation](#)

- On the login page, type your realm name, username (your account e-mail address), and password and click **Log In**.

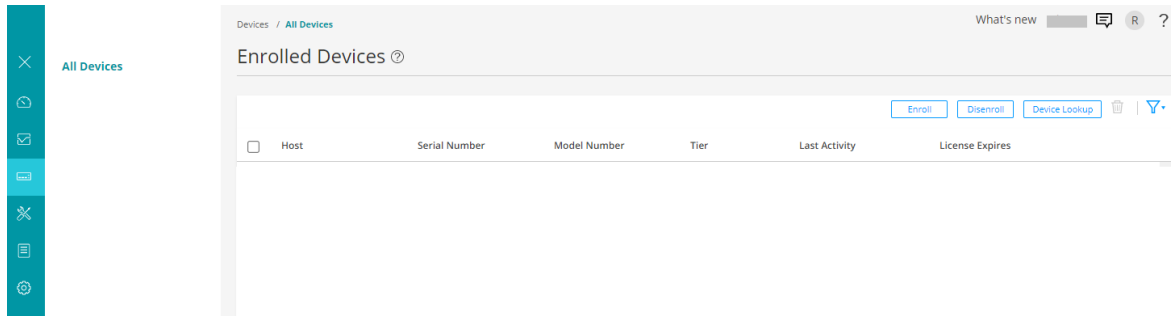
The Web UI Dashboard page appears.

**NOTE:** If you do not have a Juniper ATP Cloud account, refer to <https://www.juniper.net/documentation/us/en/software/sky-atp/sky-atp/topics/task/sky-atp-registering.html> to create a Customer Support Center (CSC) user account.

- Select **Devices > All Devices**

The Enrolled Devices page appears as shown in [Figure 91 on page 361](#).

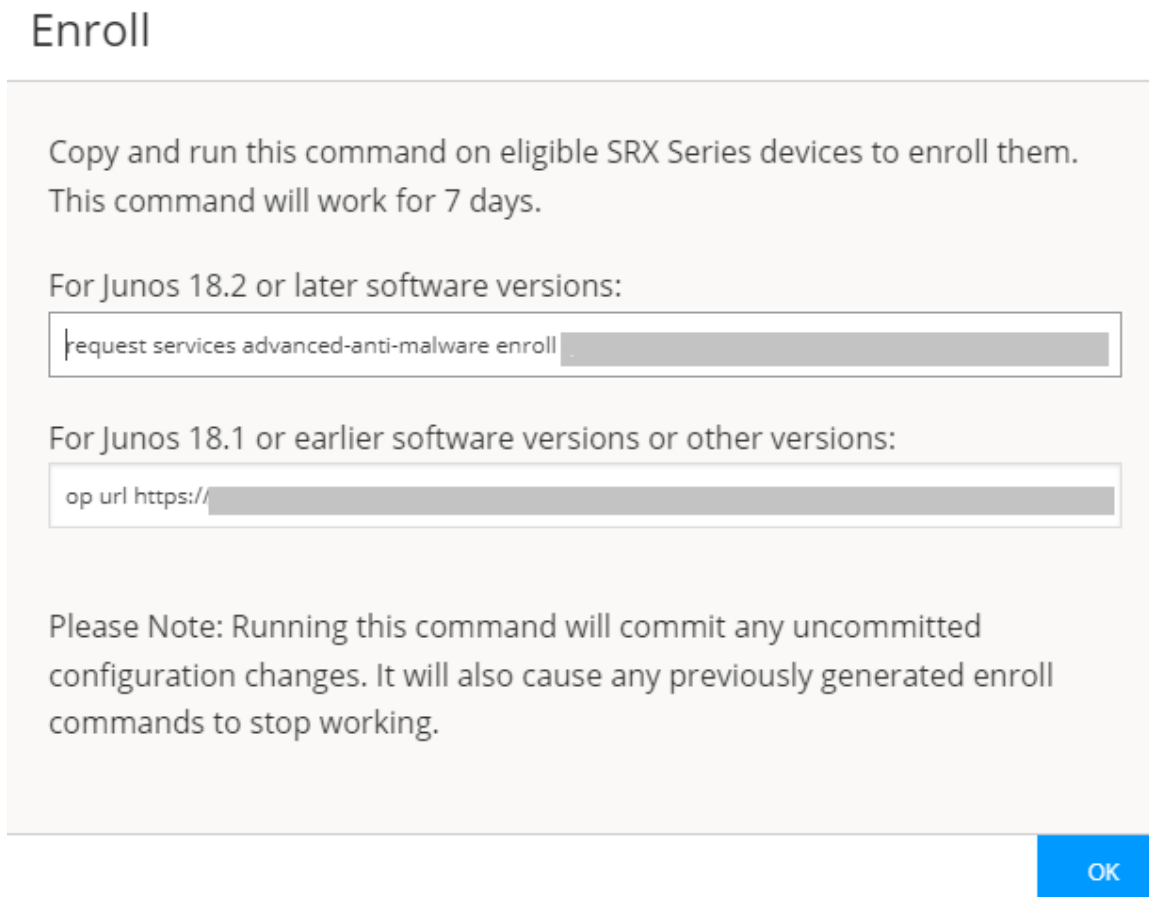
Figure 91: Enrolled Devices Page-1



4. Click the **Enroll** button.

The Enroll page appears as shown in [Figure 92 on page 361](#).

Figure 92: Enroll Page



5. Based on the Junos OS version that you are running, copy the CLI command from the page. Copy the command to your clipboard and click **OK**.

Once generated, the op url command is valid for 7 days. If you generate a new op url command within that time period, the old command is no longer valid. (Only the most recently generated op url command is valid.)

You must run the command on the vSRX Virtual Firewall to enroll it. Paste the command into the Junos OS CLI of the vSRX Virtual Firewall that you want to enroll with Juniper ATP Cloud.

6. Log in to the vSRX Virtual Firewall instance using SSH and start the CLI. The format is `ssh -i <path>/<ssh-key-pair-name>.pem ec2-user@<fxpo-elastic-IP-address>`

```
user@user-~$ ssh -i "SB-ES-Key.pem" ec2-user@XX.XXX.XXX.XX
ec2-user@awsvsrx% cli
ec2-user@awsvsrx@>
```

7. (Optional) Run the `show services advanced-anti-malware status` command to see if there are any existing configurations for ATP Cloud.

```
ec2-user@awsvsrx> show services advanced-anti-malware status
No advanced-anti-malware connection url configured.
```

8. Run the command that you previously copied from the pop-up window. Simply paste the command into the CLI and press **Enter**.

**NOTE:** You must run the op url command in operational mode.

```
ec2-user@awsvsrx> op url https://<XXXXXXXX>/v2/skyatp/ui_api/bootstrap/enroll/
xxxxxxxxxxxx.slax
Platform is supported by Sky ATP: VSRX.
Version 21.4R2 is valid for bootstrapping.
License found with name: Sky ATP.
Enrolling with Sky ATP license serial number: XXXXXXXX-XXXXXXX.
...
...
Device enrolled successfully!
```

The vSRX Virtual Firewall will make a connection to the ATP Cloud server and begin downloading and running the op scripts. The status of the enrollment appears on screen. After successful enrollment, vSRX Virtual Firewall appears on the Devices page in ATP Cloud portal.

For HA configurations, you only need to enroll the cluster primary. The cloud will detect that this is a cluster and will automatically enroll both the primary and backup as a pair. Both devices, however,

must be licensed accordingly. For example, if you want premium features, both devices must be entitled with the premium license.

**NOTE:** Juniper ATP Cloud supports both active-active and active-passive cluster configurations. The passive (non-active) node does not establish a connection to the cloud until it becomes the active node.

9. (Optional) Run the following command to view additional information:

```
ec2-user@awsvsrx> request services advanced-anti-malware diagnostics <customer-portal>
detail
```

#### Example

```
ec2-user@awsvsrx> request services advanced-anti-malware diagnostics
amer.sky.junipersecurity.net detail
```

10. Run the **show services advanced-anti-malware status** command to view the connection status and verify that a connection has been made to the ATP Cloud server from the vSRX Virtual Firewall.

```
ec2-user@awsvsrx> show services advanced-anti-malware status
Server connection status:
  Server hostname: xxx.sky.junipersecurity.net
  Server realm: <ABC realm>
  Server port: XXX
  Proxy hostname: None
  Proxy port: None
  Control Plane:
    Connection time: 2022-02-04 06:31:18 UTC
    Connection status: Connected
  Service Plane:
    master
    Connection active number: 0
    Connection retry statistics: 34
```

vSRX Virtual Firewall communicates with the cloud through multiple, persistent connections established over a secure channel (TLS 1.2). The vSRX Virtual Firewall is authenticated using SSL client certificates.

11. Refresh the **Enrolled Devices** page in ATP Cloud portal.

The Enrolled Devices page displays the new device information as shown in [Figure 93 on page 364](#). The Enrolled Devices page displays the basic connection information for all enrolled devices including serial number, model number, tier level (free or not), last activity seen, and license expiration.

**Figure 93: Enrolled Devices Page-2**

| <input type="checkbox"/> | Host    | Serial Number | Model Number | Tier    | Last Activity       | License Expires |
|--------------------------|---------|---------------|--------------|---------|---------------------|-----------------|
| <input type="checkbox"/> | awsvsrx | [REDACTED]    | VSRX         | premium | Apr 8, 2022 2:18 AM | Nov 25, 2022    |

**NOTE:** There is a 60 day grace period after the license expires before the vSRX Virtual Firewall is disenrolled from Juniper ATP Cloud.

## Using Cloud-Init to Automate the Initialization of vSRX Virtual Firewall Instances in AWS

Starting in Junos OS Release 17.4R1, the cloud-init package (version 0.7x) comes pre-installed in the vSRX Virtual Firewall for AWS image to help simplify configuring new vSRX Virtual Firewall instances operating on AWS according to a specified user-data file. Cloud-init is performed during the first-time boot of a vSRX Virtual Firewall instance.

Cloud-init is an open source application for automating the initialization of a cloud instance at boot-up. Cloud-init is designed to support multiple different cloud environments, such as Amazon EC2, so that the same virtual machine (VM) image can be directly used in multiple cloud instances without any modification. Cloud-init support in a VM instance runs at boot time (first-time boot) and initializes the VM instance according to the specified user-data file.

A user-data file is a special key in the metadata service that contains a file that cloud-aware applications in the VM instance can access upon a first-time boot. In this case, it is the validated Junos OS configuration file that you intend to upload to a vSRX Virtual Firewall instance as the active configuration. This file uses the standard Junos OS command syntax to define configuration details, such as root password, management IP address, default gateway, and other configuration statements.

When you create a vSRX Virtual Firewall instance, you can use cloud-init services on AWS to pass a valid Junos OS configuration file as user data to initialize new vSRX Virtual Firewall instances. The user-data file uses the standard Junos OS syntax to define all the configuration details for your vSRX Virtual Firewall instance. The default Junos OS configuration is replaced during the vSRX Virtual Firewall instance launch with a validated Junos OS configuration that you supply in the form of a user-data file.

**NOTE:** The user-data file cannot exceed 16 KB. If your user-data file exceeds this limit, you must compress the file using gzip and use the compressed file. For example, the `gzip junos.conf` command results in the `junos.conf.gz` file.

The configuration must be validated and include details for the `fxp0` interface, login, and authentication. It must also have a default route for traffic on `fxp0`. This information must match the details of the AWS VPC and subnet into which the instance is launched. If any of this information is missing or incorrect, the instance is inaccessible and you must launch a new one.



**WARNING:** Ensure that the user-data configuration file is not configured to perform autoinstallation on interfaces using Dynamic Host Configuration Protocol (DHCP) to assign an IP address to the vSRX Virtual Firewall. Autoinstallation with DHCP will result in a "commit fail" for the user-data configuration file.

To initiate the automatic setup of a vSRX Virtual Firewall instance from AWS:

1. If you have not done so already, create a configuration file with the Junos OS command syntax and save the file. The configuration file can be plain text or MIME file type text/plain.

The user-data configuration file must contain the full vSRX Virtual Firewall configuration that is to be used as the active configuration on each vSRX Virtual Firewall instance, and the string `#junos-config` must be the first line of the user-data configuration file before the Junos OS configuration.

**NOTE:** The `#junos-config` string is mandatory in the user-data configuration file; if it is not included, the configuration will not be applied to the vSRX Virtual Firewall instance as the active configuration.

2. Copy the Junos OS configuration file to an accessible location from where it can be retrieved to launch the vSRX Virtual Firewall instance.
3. To specify the user-data file for configuring the vSRX Virtual Firewall instance, select **As File** in the User data section on the Configure Instance Details page and attach the file (as described in *Launch a vSRX Instance on an Amazon Virtual Private Cloud*). The selected configuration file is used for the initial launch of the vSRX Virtual Firewall instance. During the initial boot-up sequence, the vSRX Virtual Firewall instance processes the cloud-init request.

**NOTE:** The boot time for the vSRX Virtual Firewall instance might increase with the use of the cloud-init package. This additional time in the initial boot sequence is due to the operations performed by the cloud-init package. During this operation, the cloud-init package halts the boot sequence and performs a lookup for the configuration data in each data source identified in the cloud.cfg. The time required to look up and populate the cloud data is directly proportional to the number of data sources defined. In the absence of a data source, the lookup process continues until it reaches a predefined timeout of 30 seconds for each data source.

4. When the initial boot-up sequence resumes, the user-data file replaces the original factory-default Junos OS configuration loaded on the vSRX Virtual Firewall instance. If the commit succeeds, the factory-default configuration will be permanently replaced. If the configuration is not supported or cannot be applied to the vSRX Virtual Firewall instance, the vSRX Virtual Firewall will boot using the default Junos OS configuration.

#### Release History Table

| Release | Description                                                                                                                                                                                                                                                                                                                                                  |
|---------|--------------------------------------------------------------------------------------------------------------------------------------------------------------------------------------------------------------------------------------------------------------------------------------------------------------------------------------------------------------|
| 17.4R1  | Starting in Junos OS Release 17.4R1, the cloud-init package (version 0.7x) comes pre-installed in the vSRX Virtual Firewall for AWS image to help simplify configuring new vSRX Virtual Firewall instances operating on AWS according to a specified user-data file. Cloud-init is performed during the first-time boot of a vSRX Virtual Firewall instance. |

#### RELATED DOCUMENTATION

[Cloud-Init Documentation](#)

[cloud-init](#)

[Launching an Instance](#)

## AWS Elastic Load Balancing and Elastic Network Adapter

#### IN THIS SECTION

- [Overview of AWS Elastic Load Balancing | 367](#)
- [Overview of Application Load Balancer | 369](#)

- [Deployment of AWS Application Load Balancer | 370](#)
- [Invoking Cloud Formation Template \(CFT\) Stack Creation for vSRX Virtual Firewall Behind AWS Application Load Balancer Deployment | 374](#)
- [Overview of AWS Elastic Network Adapter \(ENA\) for vSRX Virtual Firewall Instances | 383](#)

This section provides an overview of the AWS ELB and ENA features and also describes how these features are deployed on vSRX Virtual Firewall instances.

## Overview of AWS Elastic Load Balancing

### IN THIS SECTION

- [Benefits of AWS Elastic Load Balancing | 367](#)
- [AWS Elastic Load Balancing Components | 368](#)

This section provides information about AWS ELB.

Elastic Load Balancing (ELB) is a load-balancing service for Amazon Web Services (AWS) deployments.

ELB distributes incoming application or network traffic across intra availability zones, such as Amazon EC2 instances, containers, and IP addresses. ELB scales your load balancer as traffic to your application changes over time, and can scale to the vast majority of workloads automatically.

AWS ELB using application load balancers enables automation by using certain AWS services:

- **Amazon Simple Notification Service**—For more information, see <https://docs.aws.amazon.com/sns/latest/dg/welcome.html>.
- **AWS Lambda**—For more information, see <https://docs.aws.amazon.com/lambda/latest/dg/welcome.html>.
- **AWS Auto Scale Group**—For more information, see <https://docs.aws.amazon.com/autoscaling/ec2/userguide/AutoScalingGroup.html>.

### Benefits of AWS Elastic Load Balancing

- Ensures elastic load balancing for intra available zone by automatically distributing the incoming traffic.



- Provides flexibility to virtualize your application targets by allowing you to host more applications on the same instance and to centrally manage Transport Layer Security (TLS) settings and offload CPU-intensive workloads from your applications.
- Provides robust security features such as integrated certificate management, user authentication, and SSL/TLS decryption.
- Supports auto-scaling a sufficient number of applications to meet varying levels of application load without requiring manual intervention.
- Enables you to monitor your applications and their performance in real time with Amazon CloudWatch metrics, logging, and request tracing.
- Offers load balancing across AWS and on-premises resources using the same load balancer.

### AWS Elastic Load Balancing Components

AWS Elastic Load Balancing (ELB) components include:

- **Load balancers**—A load balancer serves as the single point of contact for clients. The load balancer distributes incoming application traffic across multiple targets, such as EC2 instances, in multiple availability zones (AZs), thereby increasing the availability of your application. You add one or more listeners to your load balancer.
- **Listeners or vSRX instances**—A listener is a process for checking connection requests, using the protocol and port that you configure. vSRX Virtual Firewall instances as listeners check for connection requests from clients, using the protocol and port that you configure, and forward requests to one or more target groups, based on the rules that you define. Each rule specifies a target group, condition, and priority. When the condition is met, the traffic is forwarded to the target group. You must define a default rule for each vSRX Virtual Firewall instance, and you can add rules that specify different target groups based on the content of the request (also known as content-based routing).
- **Target groups or vSRX application workloads**—Each vSRX Virtual Firewall application as target group is used to route requests to one or more registered targets. When you create each vSRX Virtual Firewall instance as a listener rule, you specify a vSRX Virtual Firewall application and conditions. When a rule condition is met, traffic is forwarded to the corresponding vSRX Virtual Firewall application. You can create different vSRX Virtual Firewall applications for different types of requests. For example, create one vSRX Virtual Firewall application for general requests and other vSRX Virtual Firewall applications for requests to the microservices for your application.

AWS ELB supports three types of load balancers: application load balancers, network load balancers, and classic load balancers. You can select a load balancer based on your application needs. For more information about the types of AWS ELB load balancers, see [AWS Elastic Load Balancing](#).

## Overview of Application Load Balancer

Starting in Junos OS Release 18.4R1, vSRX Virtual Firewall instances support AWS Elastic Load Balancing (ELB) using the application load balancer to provide scalable security to the Internet-facing traffic using native AWS services. An application load balancer automatically distributes incoming application traffic and scales resources to meet traffic demands.

You can also configure health checks to monitor the health of the registered targets so that the load balancer can send requests only to the healthy targets.

The key features of an application load balancer are:

- Layer-7 load balancing
- HTTPS support
- High availability
- Security features
- Containerized application support
- HTTP/2 support
- WebSockets support
- Native IPv6 support
- Sticky sessions
- Health checks with operational monitoring, logging, request tracing
- Web Application Firewall (WAF)

When the application load balancer receives a request, it evaluates the rules of the vSRX Virtual Firewall instance in order of priority to determine which rule to apply, and then selects a target from the vSRX Virtual Firewall application for the rule action. You can configure a vSRX Virtual Firewall instance rule to route requests to different target groups based on the content of the application traffic. Routing is performed independently for each target group, even when a target is registered with multiple target groups.

You can add and remove targets from your load balancer as your needs change, without disrupting the overall flow of requests to your application. ELB scales your load balancer as traffic to your application changes over time. ELB can scale majority of workloads automatically.

The application load balancer launch sequence and current screen can be viewed using the vSRX Virtual Firewall instance properties. When running vSRX Virtual Firewall as an AWS instance, logging in to the instance through SSH starts a session on Junos OS. Standard Junos OS CLI can be used to monitor health and statistics of the vSRX Virtual Firewall instance. If the `#load_balancer=true` tag is sent in user

data, then boot-up messages mention that the vSRX Virtual Firewall interfaces are configured for ELB and auto-scaling support. Interfaces eth0 and eth1 are then swapped.

If an unsupported Junos OS configuration is sent to the vSRX Virtual Firewall instance in user data, then the vSRX Virtual Firewall instance reverts to its factory-default configuration. If the #load\_balancer=true tag is missing, then interfaces are not swapped.

## Deployment of AWS Application Load Balancer

### IN THIS SECTION

- [vSRX Virtual Firewall Behind AWS ELB Application Load Balancer Deployment | 370](#)
- [Sandwich Deployment of AWS ELB Application Load Balancer | 372](#)

AWS ELB application load balancer can be deployed in two ways:

- vSRX Virtual Firewall behind AWS ELB application load balancer
- ELB sandwich

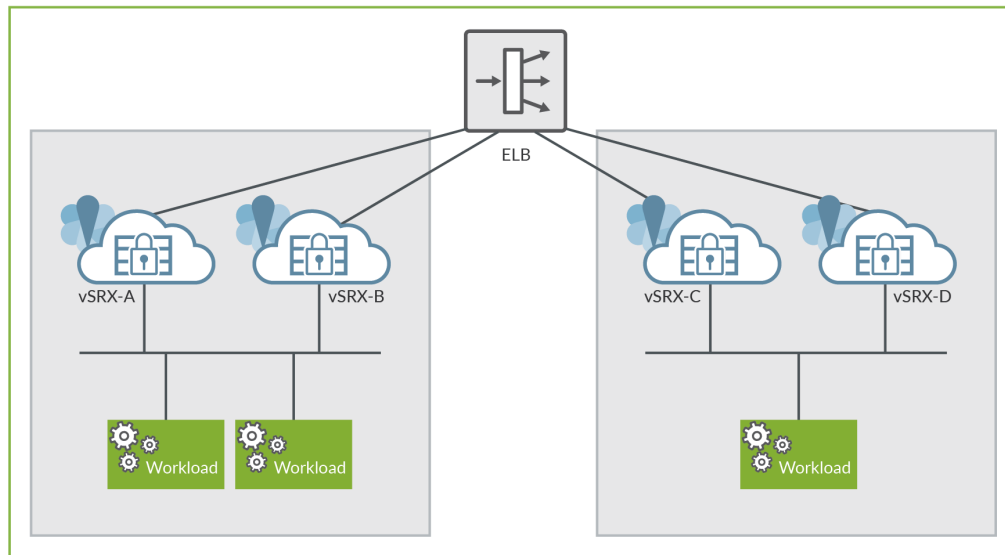
### vSRX Virtual Firewall Behind AWS ELB Application Load Balancer Deployment

In this type of deployment, the vSRX Virtual Firewall instances are attached to the application load balancer, in one or more availability zones (AZs), and the application workloads are behind the vSRX Virtual Firewall instances. The application load balancer sends traffic only to the primary interface of the instance. For a vSRX Virtual Firewall instance, the primary interface is the management interface fxp0.

To enable ELB in this deployment, you have to swap the management and the first revenue interface.

[Figure 94 on page 371](#) illustrates the vSRX Virtual Firewall behind AWS ELB application load balancer deployment.

**Figure 94: vSRX Virtual Firewall Behind AWS ELB Application Load Balancer Deployment**



### Enabling AWS ELB with vSRX Virtual Firewall Behind AWS ELB Application Load Balancer Deployment

The following are the prerequisites for enabling AWS ELB with the vSRX Virtual Firewall behind AWS ELB application load balancer type of deployment:

- All incoming and outgoing traffic to ELB are monitored from the ge-0/0/0 interface associated with the vSRX Virtual Firewall instance.
- The vSRX Virtual Firewall instance at launch has two interfaces in which the subnets containing the interfaces are connected to the internet gateway (IGW). The two interface limit is set by the AWS auto scaling group deployment. You need to define at least one interface in the same subnet as the AWS ELB. The additional interfaces can be attached by the lambda function.
- Source or destination check is disabled on the eth1 interface of the vSRX Virtual Firewall instance.

For deploying an AWS ELB application load balancer using the vSRX Virtual Firewall behind AWS ELB application load balancer method:

The vSRX Virtual Firewall instance contains:

- Cloud initialization (cloud-init) user data with ELB tag as #load\_balancer=true.
- The user data configuration with #junos-config tag, fxp0 (dhcp), ge-0/0/0 (dhcp) (must be DHCP any security group that it needs to define)

- Cloud-Watch triggers an Simple Notification Service (SNS), which in turn triggers a Lambda function that creates and attaches an Elastic Network Interface (ENI) with Elastic IP address (EIP) to the vSRX Virtual Firewall instance. Multiple new ENIs (maximum of 8) can be attached to this instance.
- The vSRX Virtual Firewall Instance must be rebooted. A reboot must be performed for all subsequent times the vSRX Virtual Firewall instance launches with swapped interfaces.

**NOTE:** Chassis cluster is not supported if you try to swap the ENI between instances and IP monitoring.

**NOTE:** You can also launch the vSRX Virtual Firewall instance in an Auto Scaling Group (ASG). This launch can be automated using a cloud formation template (CFT).

### Sandwich Deployment of AWS ELB Application Load Balancer

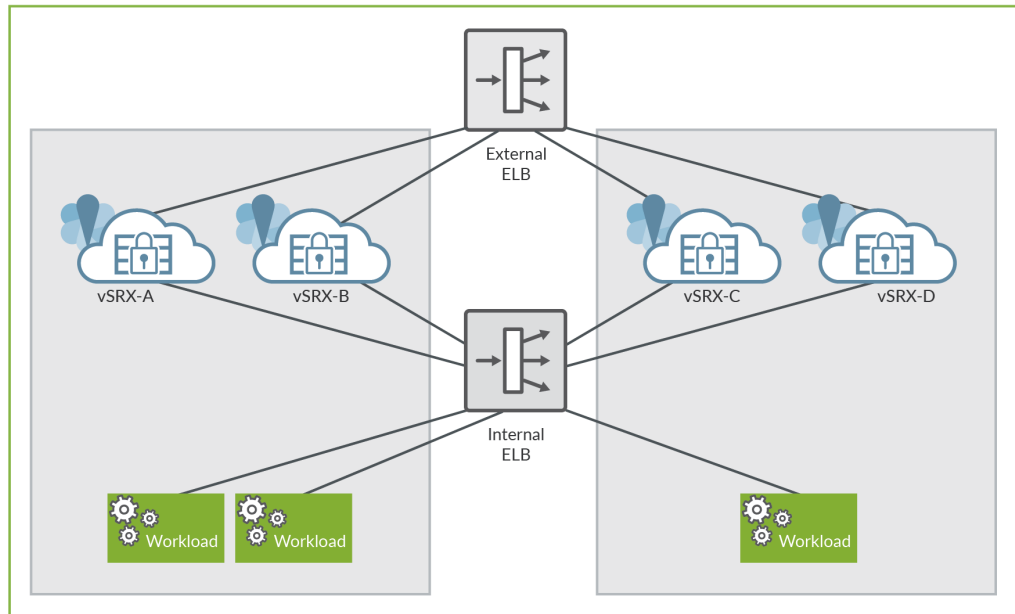
In this deployment model, you can scale both, security and applications. vSRX Virtual Firewall instances and the applications are in different ASGs and each of these ASGs is attached to a different application load balancer. This type of ELB deployment is elegant and simplified way to manually scale vSRX Virtual Firewall deployments to address planned or projected traffic increases while also delivering multi-AZ high availability. The deployment ensures inbound high availability and scaling for AWS deployments.

Because the load balancer scales dynamically, its virtual IP address (VIP) is a fully qualified domain name (FQDN). This FQDN resolves to multiple IP addresses according to the availability zone. To enable this resolution, the vSRX Virtual Firewall instance should be able to send and receive traffic from the FQDN (or the multiple addresses that it resolves to).

You configure this FQDN by using the `set security zones security-zone ELB-TRAFFIC address-book address ELB dns-name FQDN_OF_ELB` command.

[Figure 95 on page 373](#) illustrates the AWS ELB application load balancer sandwich deployment for vSRX Virtual Firewall.

Figure 95: Sandwich Deployment of AWS ELB Application Load Balancer



### Enabling Sandwich Deployment of AWS Application Load Balancer for vSRX Virtual Firewall

For AWS ELB application load balancer sandwich deployment for vSRX Virtual Firewall:

- vSRX Virtual Firewall receives the `#load_balancer=true` tag in cloud-init user data.
- In Junos OS, the initial boot process scans the mounted disk for the presence of the flag file in the `setup_vsrx` file. If the file is present, it indicates that the two interfaces with DHCP in two different virtual references must be configured. This scan and configuration update is performed in the default configuration and on top of the user data if the flag file is present.

**NOTE:** If user data is present, then the boot time after the second or the third mgd process commit increases.

- You must reboot the vSRX Virtual Firewall instance. Perform reboot for all the subsequent times the vSRX Virtual Firewall instance is launched with swapped interfaces.

**NOTE:** Chassis cluster support for swapping the Elastic Network Interfaces (ENIs) between instances and IP monitoring does not work.

**NOTE:** You can also launch vSRX Virtual Firewall instance in an ASG and automate the deployment using a cloud formation template (CFT).

## Invoking Cloud Formation Template (CFT) Stack Creation for vSRX Virtual Firewall Behind AWS Application Load Balancer Deployment

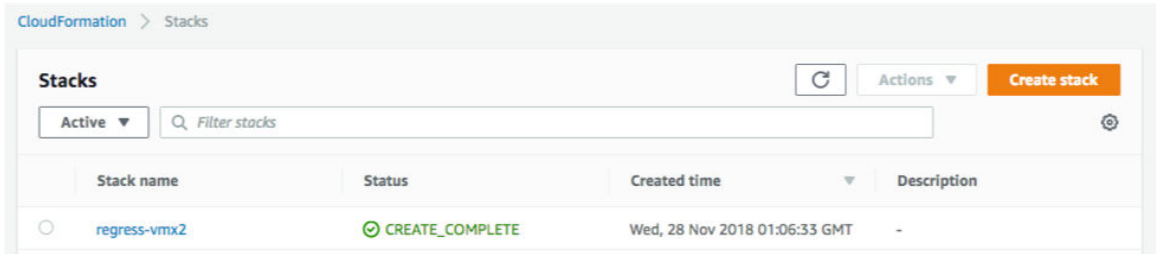
This topic provide details on how to invoke cloud formation template (CFT) stack creation for the non-sandwich deployment (with vSRX Virtual Firewall Behind AWS Application Load Balancer) which contains only one load balancer.

Before you invoke the CFT stack creation, ensure you have the following already available within AWS environment:

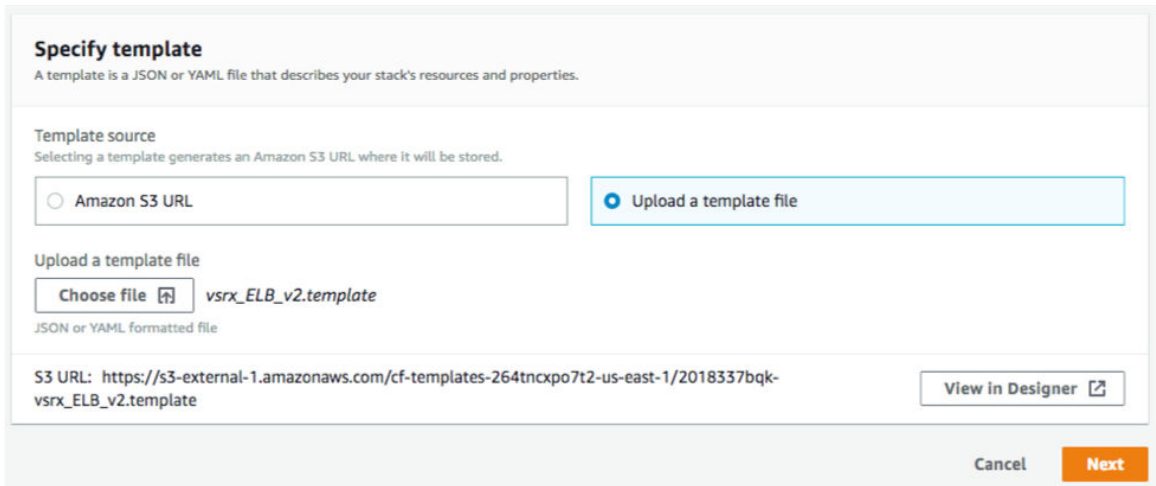
- VPC created and ready to use.
- A management subnet
- An external subnet (subnet for vSRX Virtual Firewall interface receiving traffic from the ELB).
- An internal subnet (subnet for vSRX Virtual Firewall interface sending traffic to the workload).
- An AMI ID of the vSRX Virtual Firewall instance that you want to launch.
- User data (the vSRX Virtual Firewall configuration that has to be committed before the traffic is forwarded to the workload. This is a base 64 encoded data not more than 4096 characters in length; you may use up to three user data fields if a single field data exceeds 4096 characters).
- EC2 key file.
- Get the lambda function file add\_eni.zip from Juniper vSRX Virtual Firewall GitHub repository and upload it to your instances S3 bucket. Use this information in the **Lambda S3 Location** field of the template.
- Your AWS account should have permissions to create Lambda functions on various resources in your region.

Follow the following steps to invoke CFT stack creation for AWS ELB with vSRX Virtual Firewall behind AWS ELB application load balancer deployment.

1. Log into your AWS account and make sure the region on the top right is the one you want to use. Go to AWS console home page and under **All Services** look for **Management & Governance** section and click **CloudFormation** option.
2. Click the **Create Stack** button on the top right side of the CloudFormation page.



3. On the new page, select **Upload a template file radio** button, then click **Choose file** button, and then select your template file and click **Next**.



4. The next page that opens is a form created from the template. Some fields might already have a default value, that you might change if you want to.  
Enter a **Stack Name**, select the **VPC ID**, **InstanceType**, **MgtSubnetID**, **ExternalSubnetID**, **InternalSubnetID**, **ImageID**. Paste the Base64 encoded user data (which is the vSRX Virtual Firewall configuration to be committed and is provided in a separate text file). If your Base64 encoded vSRX Virtual Firewall configuration exceeds 4096 bytes, you may use **UserData2** and **UserData3** fields as needed.
5. Set **MinASGInstances** as 1 and **MaxASGInstances** as 3
6. Select your Amazon EC2 Key Pair file and click **Next**.



## Create stack

### Stack name

Stack name

Stack name can include letters (A-Z and a-z), numbers (0-9), and dashes (-).

### Parameters

Parameters are defined in your template and allow you to input custom values when you create or update a stack.

#### vSRX configuration

VPCID

VPC ID

InstanceType

Select the instance type you want to use

MgtSubnetID

Subnet ID used for the mgmt interface

ExternalSubnetID

Subnet ID used for the revenue interface

InternalSubnetID

Subnet ID used for the internal interface

ImageID

UserData

User Data configuration. Maximum 4096 bytes. For better readability, encode it with base64. Final userdata will be the combination of UserData, UserData2 and UserData3

UserData2

User Data configuration (Optional). Maximum 4096 bytes.

UserData3

User Data configuration (Optional). Maximum 4096 bytes.

#### Auto scaling group configuration

MinASGInstances

Minimum number of vSRX in the auto scaling group

MaxASGInstances

Maximum number of vSRX in the auto scaling group

#### Other parameters

EC2KeyPair

Amazon EC2 Key Pair

Cancel

Previous

Next

7. Skip the next page with **Configure stack** options and **Advanced** option and click **Next**.

## Configure stack options

**Tags**  
You can specify tags (key-value pairs) to apply to resources in your stack. You can add up to 50 unique tags for each stack. [Learn more.](#)

|                                        |              |        |
|----------------------------------------|--------------|--------|
| <i>Key</i>                             | <i>Value</i> | Remove |
| <input type="button" value="Add tag"/> |              |        |

**Permissions**  
Choose an IAM role to explicitly define how CloudFormation can create, modify, or delete resources in the stack. If you don't choose a role, CloudFormation uses permissions based on your user credentials. [Learn more.](#)

IAM role - optional  
Choose the IAM role for CloudFormation to use for all operations performed on the stack.

|                 |                           |        |
|-----------------|---------------------------|--------|
| IAM role name ▼ | <i>Sample-role-name</i> ▼ | Remove |
|-----------------|---------------------------|--------|

## Advanced options

▶ **Stack policy**  
Defines the resources that you want to protect from unintentional updates during a stack update.

▶ **Rollback configuration**  
Specify alarms for CloudFormation to monitor when creating and updating the stack. If the operation breaches an alarm threshold, CloudFormation rolls it back. [Learn more.](#)

▶ **Notification options**  
You can choose an IAM role that CloudFormation uses to create, modify, or delete resources in the stack. If you don't choose a role, CloudFormation uses the permissions defined in your account. [Learn more.](#)

▶ **Stack creation options**

8. On the next page, you will be able to review and edit your stack creation details. Once you are done reviewing, click **Create stack** button on the bottom right of the page.

**Stack creation options**

Rollback on failure  
Enabled

Timeout  
-

Termination protection  
Disabled

▶ Quick-create link

Cancel
Previous
Create change set
Create stack

9. On the next page, wait for the stack creation to be completed. If there are any errors in the stack creation, then the errors are displayed on this page. You have to rectify the errors and recreate the stack using the above steps.
10. Once the stack is created successfully, click **Services>EC2** and then click **Auto Scaling Groups** on the left-hand side menu.

On the right-hand side of the page, you should see an auto-scaling group (ASG) with the stack name that you created.

When you select the ASG you created then that ASG details are displayed at the bottom of the page.

Click the **Scaling Policies** tab to create a scaling policy for this ASG, to maintain a certain number of vSRXs in the ASG and to cater to various requests, as per your requirements. Refer to 'Scaling policy example' under the 'Sample Data' in this topic below.

Auto Scaling Group monitors the state of the vSRX Virtual Firewall instances. It will automatically re-spawn a new instance if any vSRX Virtual Firewall instance failure is detected. You can find more information in the **Activity History** tab of the ASG and in the Cloudwatch logs.

**Auto Scaling Group: vSRX3-ELB-CFT-01-vSRXASG-1BLW7XFQ4XVJL**

Details
Activity History
Scaling Policies
Instances
Monitoring
Notifications
Tags
Scheduled Actions
Lifecycle Hooks

Add policy

**vSRX3\_ELB\_SP01**

---

**Policy type:** Target Tracking scaling

**Execute policy when:** As required to maintain Application Load Balancer Request Count Per Target at 5000

**Take the action:** Add or remove instances as required

**Instances need:** 15 seconds to warm up after scaling

**Disable scale-in:** No

- Click **Services**>**EC2** and then **Load Balancers** on the left-hand side menu. On the right-hand side of the page, you should see a load balancer (LB) with the stack name that you created. You can select this load balancer and view the load balancer details at the bottom of the page.

The **instances** tab above will show the vSRX Virtual Firewall instances being load-balanced by this LB. This LB will be assigned a DNS name as show above. Any HTTP traffic sent to that host will be forwarded by the vSRX Virtual Firewall to the web server workload being protected by the vSRX Virtual Firewall. The number of vSRX Virtual Firewall instances can vary between **MinASGInstances** and **MaxASGInstances** used during setup, depending upon the scaling criteria.

Load balancer: **sichao-v3-External-162OH8ELJZL71**

Description Instances Health check Listeners Monitoring Tags Migration

**Basic Configuration**

|                           |                                                                                   |                      |                                        |
|---------------------------|-----------------------------------------------------------------------------------|----------------------|----------------------------------------|
| <b>Name</b>               | sichao-v3-External-162OH8ELJZL71                                                  | <b>Creation time</b> | September 14, 2018 at 3:19:04 PM UTC-7 |
| <b>* DNS name</b>         | sichao-v3-External-162OH8ELJZL71-668480999.us-east-1.elb.amazonaws.com (A Record) | <b>Hosted zone</b>   | Z35SXDOTRQ7X7K                         |
| <b>Type</b>               | Classic (Migrate Now)                                                             | <b>Status</b>        | 0 of 0 instances in service            |
| <b>Scheme</b>             | internet-facing                                                                   | <b>VPC</b>           | vpc-f00c6b8b                           |
| <b>Availability Zones</b> | subnet-eb6bfa1 - us-east-1b                                                       |                      |                                        |

## 12. For Scaling a Policy:

- As mentioned in Step 11, click on **Add policy** on the **Scaling Policies** tab of your Auto Scaling Group (ASG) and name the policy.
- Select a **Metric type** from the drop down list, for example: for Average CPU Utilization, enter a **Target Value** as 75. Add 30 seconds warm-up time the vSRX Virtual Firewall instances need and leave **Disable scale-in** unchecked.
- Click **Create** to add this policy to the ASG. The ASG executes the policy as required to maintain average CPU utilization at 75.

## Sample Configuration of AWS Elastic Load Balancer with vSRX Virtual Firewall instance for HTTP Traffic

- You need to have your DNS server IP and your Web Server IP (or if your web server is behind a load balancer, then use that load balancer's IP address below instead of the Web Server IP).
- After using your IP addresses in the below configuration, convert this configuration into Base 64 format (refer to: <https://www.base64encode.org/>) and then paste the converted configuration into the UserData field. By doing so, applies the below configuration to the existing default configuration on a vSRX Virtual Firewall launched in AWS, during the stack creation process.

```
#load_balancer=true
#junos-config
system {
  name-server {
```

```
<Your DNS Server IP>
}
  syslog {
    file messages {
      any any;
    }
  }
}
security {
  address-book {
    global {
      address webserv <Your Web Server IP>/32;
    }
  }
  nat {
    source {
      rule-set src-nat {
        from interface ge-0/0/0.0;
        to zone trust;
        rule rule1 {
          match {
            source-address 0.0.0.0/0;
            destination-port {
              80;
            }
          }
          then {
            source-nat {
              interface;
            }
          }
        }
      }
    }
  }
  destination {
    pool pool1 {
      address <Your Web Server IP>/32;
    }
  }
  rule-set dst-nat {
    from interface ge-0/0/0.0;
    rule rule1 {
      match {
        destination-address 0.0.0.0/0;
      }
    }
  }
}
```



```
security-zone untrust {
  host-inbound-traffic {
    system-services {
      any-service;
    }
    protocols {
      all;
    }
  }
  interfaces {
    ge-0/0/0.0;
  }
}
}
}
interfaces {
  ge-0/0/0 {
    unit 0 {
      family inet {
        dhcp;
      }
    }
  }
  ge-0/0/1 {
    unit 0 {
      family inet {
        dhcp;
      }
    }
  }
}
routing-instances {
  ELB_RI {
    instance-type virtual-router;
    interface ge-0/0/0.0;
    interface ge-0/0/1.0;
  }
}
```

## Overview of AWS Elastic Network Adapter (ENA) for vSRX Virtual Firewall Instances

### IN THIS SECTION

- [Benefits | 383](#)
- [Understanding AWS Elastic Network Adapter | 383](#)

Amazon Elastic Compute Cloud (EC2) provides the Elastic Network Adapter (ENA), the next-generation network interface and accompanying drivers that provide enhanced networking on EC2 vSRX Virtual Firewall instances.

Amazon EC2 provides enhanced networking capabilities through the Elastic Network Adapter (ENA).

### Benefits

- Supports multiqueue device interfaces. ENA makes use of multiple transmit and receive queues to reduce internal overhead and to increase scalability. The presence of multiple queues simplifies and accelerates the process of mapping incoming and outgoing packets to a particular vCPU.
- The ENA driver supports industry-standard TCP/IP offload features such as checksum offload and TCP transmit segmentation offload (TSO).
- Supports receive-side scaling (RSS) network driver technology that enables the efficient distribution of network receive processing across multiple CPUs in multiprocessor systems, for multicore scaling. Some of the ENA devices support a working mode called low-latency queue (LLQ), which saves several microseconds.

### Understanding AWS Elastic Network Adapter

Enhanced networking uses single-root I/O virtualization (SR-IOV) to provide high-performance networking capabilities on supported instance types. SR-IOV is a method of device virtualization that provides higher I/O performance and lower CPU utilization when compared to traditional virtualized network interfaces. Enhanced networking provides higher bandwidth, higher packet per second (pps) performance, and consistently lower inter-instance latencies. There is no additional charge for using enhanced networking.

ENA is a custom network interface optimized to deliver high throughput and packet per second (pps) performance, and consistently low latencies on EC2 vSRX Virtual Firewall instances. Using ENA for vSRX Virtual Firewall C5.large instances (with 2 vCPUs and 4-GB memory), you can utilize up to 20 Gbps of network bandwidth. ENA-based enhanced networking is supported on vSRX Virtual Firewall instances.



The ENA driver exposes a lightweight management interface with a minimal set of memory-mapped registers and an extendable command set through an admin queue. The driver supports a wide range of ENA adapters, is link-speed independent (that is, the same driver is used for 10 Gbps, 25 Gbps, 40 Gbps, and so on), and negotiates and supports various features. The ENA enables high-speed and low-overhead Ethernet traffic processing by providing a dedicated Tx/Rx queue pair per CPU core.

The DPDK drivers for ENA are available at <https://github.com/amzn/amzn-drivers/tree/master/userspace/dpdk>.

**NOTE:** When AWS ELB application load balancers are used, the eth0 (first) and eth1 (second) interfaces are swapped for the vSRX Virtual Firewall instance. The AWS ENA detects and rebinds the interface with its corresponding kernel driver.

## Multi-Core Scaling Support on AWS with SWRSS and ENA

EC2 instance types are predefined by AWS. You cannot launch an instance with an arbitrary number of vCPUs. This scenario leads to a gap between the resource AWS provides and the resource that vSRX Virtual Firewall 3.0 can use.

As an example: For AWS C5.4xlarge without software RSS, vSRX Virtual Firewall 3.0 will be launched with 9 vCPUs. Whereas we have 16 vCPUs that can be used. So, the remaining 7 vCPUs offered by AWS are wasted. With Software RSS, the hardware RSS queue limitation is removed. With more software queue available, more vCPUs can be deployed as data vCPUs.

Starting in Junos OS Release 19.4R1, vSRX Virtual Firewall 3.0 instances with the Software Receive Side Scaling (SWRSS) feature can scale up the number of vCPUs on instances with ENA support in AWS. The ENA enabled instances allow for more RSS queues. With the SWRSS feature, the dynamic ratio between number of vCPUs and RSS queues allows for the scale up of vSRX Virtual Firewall with larger AWS EC2 instances.

Software RSS supports up to 32 vCPUs. Launching vSRX Virtual Firewall into EC2 instance with more than 32 vCPUs will not provide further benefits. To support multi-core scaling you need to ensure SWRSS is enabled on vSRX Virtual Firewall instances.

With this feature support the AWS instances type supported by vSRX Virtual Firewall are c5.large, c5.xlarge, c5.2xlarge, c5.4xlarge, and c5.9xlarge. For more information, see [Amazon EC2 Instance Types](#).

## Centralized Monitoring and Troubleshooting using AWS Features

### IN THIS SECTION

- [Understanding Centralized Monitoring Using Cloudwatch | 385](#)
- [Integration of vSRX Virtual Firewall with AWS Monitoring and Troubleshooting Features | 393](#)

This topic provides you details on how you can perform monitoring and troubleshooting of your vSRX Virtual Firewall instances on the AWS console by integrating vSRX Virtual Firewall with CloudWatch, IAM, and Security Hub.

### Understanding Centralized Monitoring Using Cloudwatch

#### IN THIS SECTION

- [Benefits | 391](#)
- [CloudWatch Overview | 391](#)
- [Security Hub Overview | 392](#)
- [Identity and Access Management Console | 392](#)

AWS provides a comprehensive view of various metrics, logs, security events from third-party services across AWS accounts. With the support of CloudWatch, vSRX Virtual Firewall can publish native metrics and logs to cloud, which you can use to monitor vSRX Virtual Firewall running status. Security Hub is the single place that aggregates, organizes and prioritizes security alerts.

The CloudWatch logs agent provides an automated way to send log data to CloudWatch Logs from Amazon EC2 instances. The agent pushes log data to CloudWatch Logs.

The cloudagent daemon that runs on the vSRX Virtual Firewall allows integration of AWS CloudWatch and Security Hub. The cloudagent:

- Collects device metrics and send metrics to AWS CloudWatch
- Collects system and security logs and sends the logs to AWS CloudWatchLog

Any event type (component or log level) that can be collected by the cloudagent under vSRX Virtual Firewall event log mode is supported for CloudWatch log collection. Events supported for CloudWatchLog are:

- System activities such as Interfaces status (up/down), configuration changes, user login/logout and so on.
- Security events such as IDP, ATP Cloud, and security logs such as Content Security logs, and Screen, ATP Cloud and so on.
- Collects security alerts and import those alerts to Security Hub in security finding format.

To import security events to Security Hub, you need to configure CloudWatch log collection and import the security events based on the log messages.

Security Hub collects security data from across AWS accounts, services, and supported third-party partners and helps you analyze your security trends and identify the highest priority security issues. After the AWS security hub support is added on vSRX Virtual Firewall, it helps administrator reduces the effort of collecting and prioritizing security findings across accounts. With the help of Security hub, you can run automated, continuous account-level configuration and compliance checks based on vSRX Virtual Firewall security output.

For the list of events and metrics that are imported, see [Table 74 on page 386](#) and [Table 75 on page 389](#).

For more information on the events and their purpose, see [Juniper System Log Explorer](#).

**Table 74: Events Imported to Security Hub**

Metric	Description
AV_MANY_MSGS_NOT_SCANNED_MT	Skip antivirus scanning due to excessive traffic
WEBFILTER_URL_BLOCKED	Web request blocked
AAMW_CONTENT_FALLBACK_LOG	AAMW content fallback info
AV_MANY_MSGS_DROPPED_MT	Drop the received file due to excessive traffic

**Table 74: Events Imported to Security Hub (Continued)**

Metric	Description
PFE_SCREEN_MT_CFG_ERROR	screen config failure
WEBFILTER_URL_REDIRECTED	Web request redirected
AV_FILE_NOT_SCANNED_PASSED_MT	The antivirus scanner passed the received traffic without scanning because of exceeding the maximum content size
RT_SCREEN_TCP_SRC_IP	TCP source IP attack
RT_SCREEN_SESSION_LIMIT	Session limit
SECINTEL_ACTION_LOG	Secintel action info
IDP_APPDDOS_APP_STATE_EVENT	IDP: DDOS application state transition event
AAMW_HOST_INFECTED_EVENT_LOG	AAMW cloud host status event info
IDP_ATTACK_LOG_EVENT	IDP attack log
IDP_SESSION_LOG_EVENT	IDP session event log
AAMW_MALWARE_EVENT_LOG	AAMW cloud malware event info
WEBFILTER_URL_PERMITTED	Web request permitted
IDP_PACKET_CAPTURE_LOG_EVENT	IDP packet capture event log
RT_SCREEN_WHITE_LIST	Screen white list

Table 74: Events Imported to Security Hub (Continued)

Metric	Description
RT_SCREEN_IP	IP attack
AAMW_SMTP_ACTION_LOG	AAMW SMTP action info
RT_SCREEN_TCP_DST_IP	TCP destination IP attack
IDP_APPDDOS_APP_ATTACK_EVENT	IDP: DDOS attack on application
RT_SCREEN_ICMP	ICMP attack
IDP_TCP_ERROR_LOG_EVENT	IDP TCP error log
AV_FILE_NOT_SCANNED_DROPPED_MT	The antivirus scanner dropped the received traffic without scanning because of exceeding the maximum content size
AAMW_ACTION_LOG	AAMW action info
PFE_SCREEN_MT_ZONE_BINDING_ERROR	screen config failure
AV_VIRUS_DETECTED_MT	The antivirus scanner detected a virus
PFE_SCREEN_MT_CFG_EVENT	screen config
RT_SCREEN_TCP	TCP attack
RT_SCREEN_UDP	UDP attack
AV_SCANNER_DROP_FILE_MT	The antivirus scanner dropped the received traffic because of an internal error

**Table 74: Events Imported to Security Hub (Continued)**

Metric	Description
AAMW_IMAP_ACTION_LOG	AAMW IMAP action info
AV_SCANNER_ERROR_SKIPPED_MT	Skip antivirus scanning due to an internal error
AV_MEMORY_INSUFFICIENT_MT	The DRAM size is too small to support antivirus

**Table 75: Supported vSRX Virtual Firewall Metrics Published on CloudWatch by Coudagent**

Metric	Unit	Description
ControlPlaneCPUUtil	Percent	Utilization of the CPU on which control plane tasks are running
DataPlaneCPUUtil	Percent	Utilization of each CPU on which data plane tasks are running
DiskUtil	Percent	Disk storage utilization
ControlPlaneMemoryUtil	Percent	Memory utilization of control plane tasks
DataPlaneMemoryUtil	Percent	Memory utilization of data plane task
FlowSessionInUse	Count	Monitors the number of flow session in use, including all those sessions are allocated in valid, invalid, pending and other states.
FlowSessionUtil	Percent	Flow session utilization
RunningProcesses	Count	Number of processes in running state.
Ge00XInputKBPS	Kilobits/Second	Interfaces input statistics on Kilobits per second. Each GE interface will be monitored separately.

**Table 75: Supported vSRX Virtual Firewall Metrics Published on CloudWatch by Coudagent**  
(Continued)

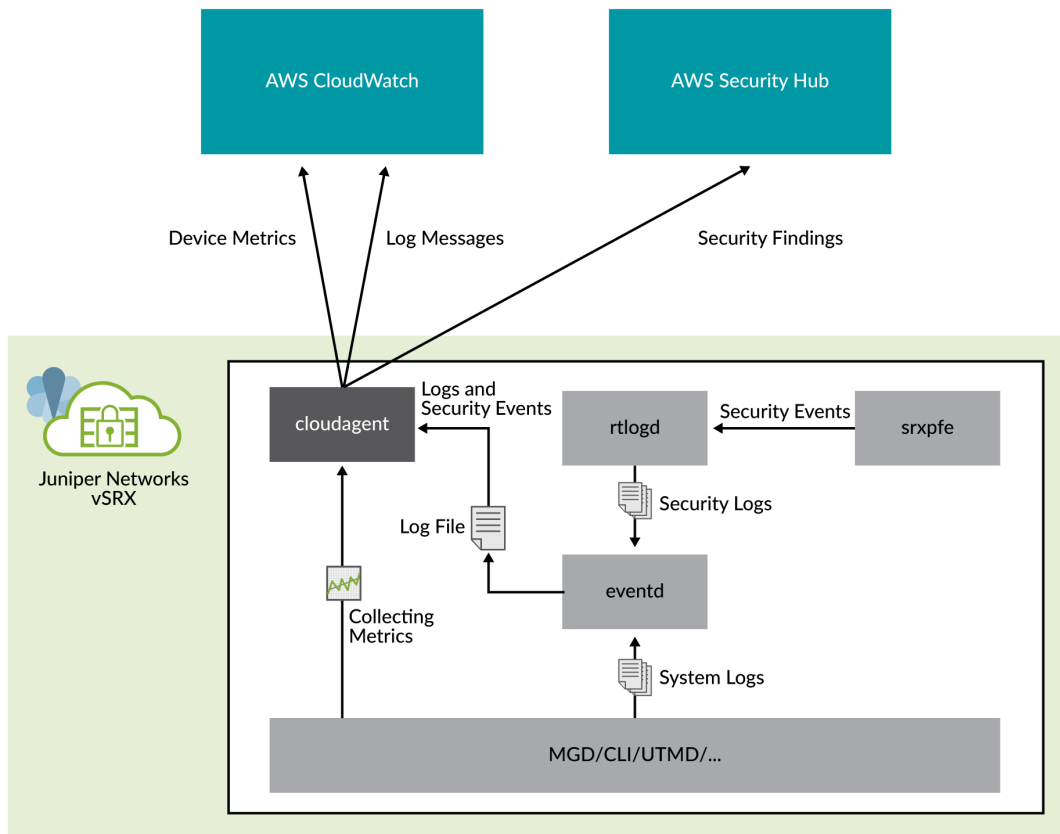
Metric	Unit	Description
Ge00XInputPPS	Count/Second	Interfaces input statistics on packets per second. Each GE interface will be monitored separately.
Ge00XOutputKBPS	Kilobits/Second	Interfaces output statistics on Kilobits per second. Each GE interface will be monitored separately.
Ge00XOutputPPS	Count/Second	Interfaces output statistics on packets per second. Each GE interface will be monitored separately.

Besides the agent running in vSRX Virtual Firewall, you must configure the AWS console to enable CloudWatch and Security Hub service for vSRX Virtual Firewall, including:

- Grant privileges for vSRX Virtual Firewall to post data to CloudWatch and Security Hub
- Create a role with corresponding permission in AWS Identity and Access Management (IAM) console
- Attach the role to vSRX Virtual Firewall instances in AWS EC2 console
- Configure CloudWatch dashboard to display metric items with chart widget

[Figure 96 on page 391](#) shows how a cloudagent collects data from vSRX Virtual Firewall and posts to AWS services.

Figure 96: Integration of AWS Cloudwatch on vSRX Virtual Firewall 3.0



### Benefits

- Observability of events and data on a single platform across applications and infrastructure
- Easiest way to collect metric in AWS and on-premises
- Improve operational performance and resource optimization
- Get operational visibility and insight
- Derive actionable insights from logs

### CloudWatch Overview

Amazon CloudWatch is a monitoring and management service built for developers, system operators, site reliability engineers (SRE), and IT managers. CloudWatch provides you with data and actionable insights to monitor your applications, understand and respond to system-wide performance changes, optimize resource utilization, and get a unified view of operational health.



You can use CloudWatch to detect anomalous behavior in your environments, set alarms, visualize logs and metrics side by side, take automated actions, troubleshoot issues, and discover insights to keep your vSRX Virtual Firewall 3.0 instances running smoothly.

CloudWatch collects monitoring and operational data in the form of logs, metrics, and events, and visualizes it using automated dashboards so you can get a unified view of your AWS resources, applications, and services that run in AWS and on-premises. You can correlate your metrics and logs to better understand the health and performance of your resources. You can also create alarms based on metric value thresholds you specify, or that can watch for anomalous metric behavior based on machine learning algorithms. To take action quickly, you can set up automated actions to notify you if an alarm is triggered and automatically start auto scaling, for example, to help reduce mean-time-to-resolution. You can also dive deep and analyze your metrics, logs, and traces, to better understand how to improve application performance.

### **Security Hub Overview**

AWS Security Hub gives you a comprehensive view of your high-priority security alerts and compliance status across AWS accounts. Security Hub is the single place that aggregates, organizes, and prioritizes security alerts. vSRX Virtual Firewall supports Security Hub with authentication to post security finding data to Security Hub.

Various security alerts from your vSRX Virtual Firewall instances are collected by Security Hub. With the integration of Security Hub, you now have a single place that aggregates, organizes, and prioritizes your security alerts, or findings, from your vSRX Virtual Firewall instances. Your findings are visually summarized on integrated dashboards with actionable graphs and tables. You can also continuously monitor your environment using automated compliance checks based on the AWS best practices and Juniper standards. Enable Security Hub using the management console and once enabled, Security Hub will begin aggregating and prioritizing the findings.

### **Identity and Access Management Console**

AWS Identity and Access Management (IAM) enables you to manage access to AWS services and resources securely. Using IAM, you can create and manage AWS users and groups, and use permissions to allow and deny their access to AWS resources.

IAM is a feature of your AWS account offered at no additional charge.

## Integration of vSRX Virtual Firewall with AWS Monitoring and Troubleshooting Features

### IN THIS SECTION

- [Grant Permission for vSRX Virtual Firewall to access AWS CloudWatch and Security Hub | 393](#)
- [Enable Monitoring of vSRX Virtual Firewall Instances with AWS CloudWatch Metric | 395](#)
- [Collect, Store, and View vSRX Virtual Firewall Logs to AWS CloudWatch | 396](#)
- [Enable and Configure Security Hub on vSRX Virtual Firewall | 397](#)

This topic provides details on how to integrate CloudWatch and Security Hub with vSRX Virtual Firewall 3.0 for centralized monitoring and troubleshooting on the AWS console.

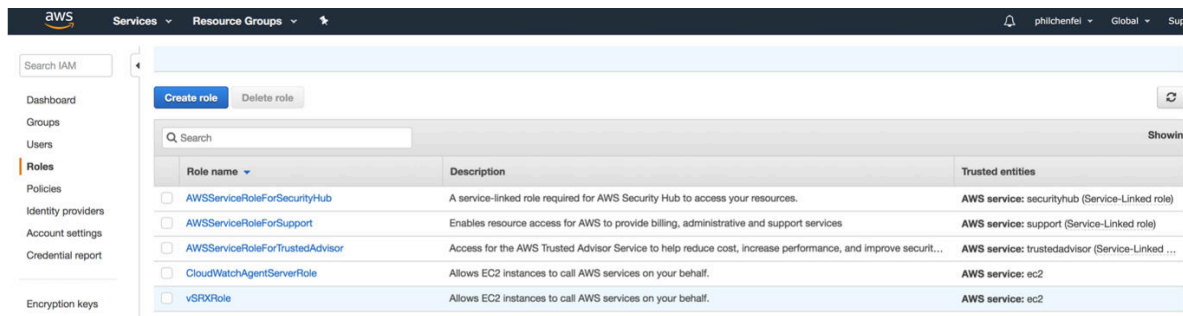
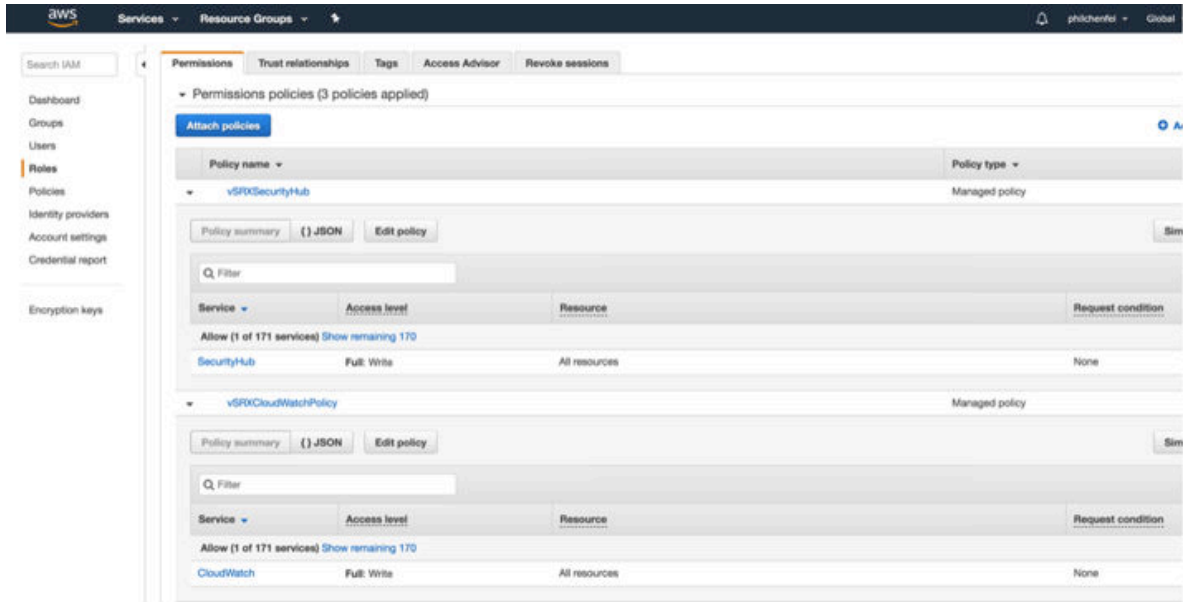
### Grant Permission for vSRX Virtual Firewall to access AWS CloudWatch and Security Hub

This section provides you details on how to enable access on vSRX Virtual Firewall instances to interact with AWS CloudWatch and Security Hub.

**1.** Create an IAM role using AWS IAM console.

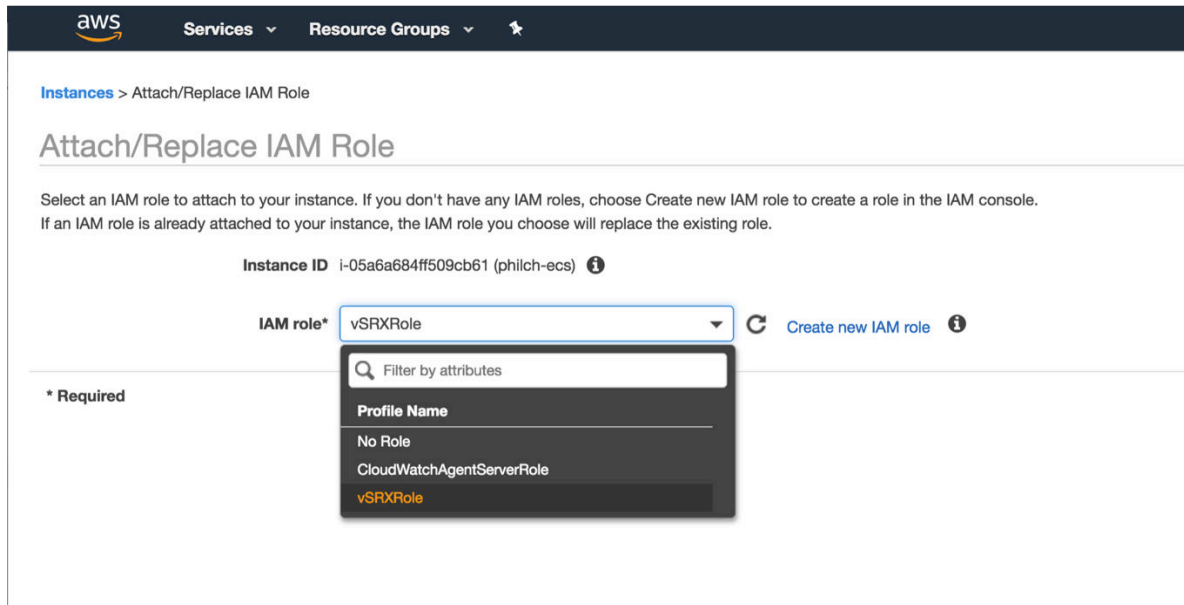
Login to AWS IAM console, create IAM role and attach the role to vSRX Virtual Firewall instances to grant those permissions. You must create an IAM role before you can launch an instance with that role or attach it to an instance. For more information, see [IAM Roles for Amazon EC2](#).

**2.** Configure an IAM role on the AWS console and attach the role to vSRX Virtual Firewall instance. After you create an IAM role, the role can be viewed on IAM console and edited as necessary.



3. To launch an instance with an IAM role or to attach or replace an IAM role for an existing instance, permissions have to be granted to pass the role to the instance. AWS has to grant permission to pass an IAM role to an instance. For more information, see [Granting an IAM User Permission to Pass an IAM Role to an Instance](#).
4. Attach an IAM role to vSRX Virtual Firewall instances by selecting a IAM role and the vSRX Virtual Firewall instance ID under the **Attach/Replace IAM Role** tab on the AWS console as shown in [Figure 97 on page 395](#). With the created role, you can enable CloudWatch and Security Hub access for vSRX Virtual Firewall instance by attaching the role.

Figure 97: Attach or Replace IAM Role to the vSRX Virtual Firewall Instances



## Enable Monitoring of vSRX Virtual Firewall Instances with AWS CloudWatch Metric

This procedure provides us steps to enable monitoring of vSRX Virtual Firewall with AWS CloudWatch Metric.

Metric is data about the performance of the system. By enabling CloudWatch Metric monitoring, you can monitor some resources of vSRX Virtual Firewall instances.

1. Enable CloudWatch and Security Hub using the AWS console.
2. Configure CloudWatch metric in the Cloudwatch agent.

To enable CloudWatch metric monitoring, you need to configure metric namespace and collection interval on the instance by executing the **# set security cloud aws cloudwatch metric namespace <namespace> collect-interval <integer>** command.

A namespace is a container for CloudWatch metrics. Metric in different namespaces are isolated from each other, so that metrics from different applications are not mistakenly aggregated into the same statistics. Different vSRX Virtual Firewall instances can use same CloudWatch metric namespace. Metric from different vSRX Virtual Firewall instances can be differentiated by dimensional data (instances id/name) in metric value.

Collection interval is the frequency at which the firewall publishes the metrics to CloudWatch. The value can be set between 1 minute and 60 minutes. The default value is 3 minutes.

Once the Cloudwatch metric monitoring is enabled, the cloudagent running on vSRX Virtual Firewall collects all the required metric and publishes the metric data on the Cloudwatch.

Once monitoring is enabled you can view CloudWatch Metric. CloudWatch metric can be graphed after cloudagent starts to collect and post metric data to the cloud. By selecting the metric namespaces created from vSRX Virtual Firewall on AWS CloudWatch console, administrator can check and display all metric data. Check AWS CloudWatch guide for how to filter and display on those collected metric.

3. View the Cloudwatch metric data. CloudWatch metrics can be graphed after cloudagent starts to collect and post metric data to cloud.
4. Configure CloudWatch dashboard to display metric items with chart widget.

Amazon CloudWatch dashboards are customizable home pages in the CloudWatch console that you can use to monitor your resources in a single view, even those resources that are spread across different regions. You can manually create a dashboard for the vSRX Virtual Firewall under monitoring.

### Collect, Store, and View vSRX Virtual Firewall Logs to AWS CloudWatch

CloudWatch Logs are used to monitor, store, and access log files from Amazon Elastic Compute Cloud (Amazon EC2) instances, AWS CloudTrail, Route 53, and other sources. For a vSRX Virtual Firewall instance, cloudagent collects both system and security logs and then post these logs to CloudWatchLog. The log collection in cloudagent will cache logs in a time window and post them to CloudWatchLog in a batch.

This procedure provides you details on how to enable and configure CloudWatch Logs on vSRX Virtual Firewall

1. To enable log collection for CloudWatchLog, you need to configure a log group, collect interval and from which file to collect log messages on the device.

```
# set security cloud aws cloudwatch log group vsrx-group
# set security cloud aws cloudwatch log file mylog collect-interval 2
# set security cloud aws cloudwatch log file syslog collect-interval 1
```

A log stream is a sequence of log events that share the same source. Each separate source of logs into CloudWatch Logs makes up a separate log stream. For log collection, one vSRX Virtual Firewall will post logs as a dedicated stream which means vSRX Virtual Firewall will automatically create a log stream in the destination log group.

A log group is a group of log streams that share the same retention, monitoring, and access control settings. By defining the log groups on the vSRX Virtual Firewall instance, you can specify which streams are placed into which group.

Collection interval is the frequency at which the firewall publishes logs to CloudWatchLog. The value can be set between 1 minute and 60 minutes. The default value is 3 minutes.

Three vSRX Virtual Firewall log files can be collected in CloudWatch simultaneously per vSRX Virtual Firewall instance. Each log file will create a corresponding a log stream in Cloudwatch. The log stream will be named under log group with convention <vsrx\_instance\_id> <log\_file\_name>.

After you enable CloudWatch logging in the cloudagent on vSRX Virtual Firewall instances, you need to configure syslog message file.

## 2. Configure the syslog message file.

Any filters can be applied based on vSRX Virtual Firewall syslog filtering. It provides the capability to define which log messages will be sent to CloudWatchLogs. For example, the below configuration means system will log any error messages to the syslog file under the **/var/log** and cloudagent will collect the messages from **/var/log/syslog** and post the messages to CloudWatchLogs.

```
# set security cloud aws cloudwatch log file syslog collect-interval 1
# set system syslog file syslog any error
```

## 3. View and search vSRX Virtual Firewall logs on CloudWatchLog console. Log groups and stream will be created automatically after configured on vSRX Virtual Firewall instances.

Select the log group and stream to check and search those logs sent to CloudWatch from the vSRX Virtual Firewall instance.

## Enable and Configure Security Hub on vSRX Virtual Firewall

To import security events to AWS Security Hub, you need to configure CloudWatch log collection and then import the security events based on the log messages.

For example:

```
# set security cloud aws cloudwatch log group vsrx-group
# set security cloud aws cloudwatch log file mylog security-hub-import
# set security cloud aws cloudwatch log file mylog collect-interval 1
# set system syslog file mylog any any
# set system syslog file mylog structured-data
```

In the above configuration you are configuring CloudWatch log collection on file mylog under **/var/log** directory and any security events in the log file will be imported from the vSRX Virtual Firewall to Security Hub in the AWS security finding format.

**NOTE:** The security-hub-import option is only supported on log files with structured-data format. Which means if a message is logged with plain text format, security events in log messages cannot be converted to AWS security finding and imported to Security Hub.

You can view the security findings posted from vSRX Virtual Firewall on the Security Hub console.

The screenshot displays the AWS Security Hub console. On the left, a table lists findings with columns for Severity, Company, Product, Title, Resource ID, and Resource Name. A filter is applied: 'Record state EQUALS ACTIVE'. The table shows four findings, all with a severity of 'LOW'. The first finding is titled 'Account Compromise title, to test security hub' and is associated with a Juniper-vSRX resource. The right pane shows the details for this finding, including the Account ID (016135515484), Severity (Original: 23, Normalized: 23), Created at (2019-03-05T10:08:16Z), Updated at (2019-03-05T10:08:16Z), Severity label (LOW), and Company (Personal). It also shows related resources, including the Juniper-vSRX resource with its Resource ID (i-05a6a684ff509cb61).

Severity	Company	Product	Title	Resource ID	Resource Name
LOW	Personal	Default	Account Compromise title, to test security hub	i-05a6a684ff509cb61	Juniper-vSRX
LOW	Personal	Default	Account Compromise title, to test security hub	phlich@juniper.net	Email Address
LOW	AWS	Security Hub	1.22 Ensure IAM policies that allow full administrative privileges are not created	AWS::Account: 016135515484	AwsAccount
LOW	AWS	Security	1.10 Ensure IAM password policy	AWS::Account: 016135515484	AwsAccount

## Deploying vSRX Virtual Firewall 3.0 for Securing Data using AWS KMS

### IN THIS SECTION

- Integrate AWS KMS with vSRX Virtual Firewall 3.0 | 398
- AWS Cloud Formation Templates | 402

### Integrate AWS KMS with vSRX Virtual Firewall 3.0

A wrapper library is available in Junos to enable VPN and other applications (such as mgd) to integrate and to communicate AWS KMS with vSRX Virtual Firewall 3.0. This wrapper library provides interface to

Key Management Service (KMS) using PKCS#11 APIs. Junos applications use this wrapper library with updated support for AWS cloud platform to communicate with KMS.

To enable and setup vSRX Virtual Firewall 3.0 to access KMS on AWS.

1. Launch vSRX Virtual Firewall 3.0 instance on AWS.
2. Setup KMS and DynamoDB for vSRX Virtual Firewall 3.0.

Before you can use vSRX Virtual Firewall to communicate with KMS service, you need to setup AWS environment/account by doing the following:

- a. Create a DynamoDB table.

DynamoDB service on AWS is used by KMS PKCS11 process to store and to manage key information created by vSRX Virtual Firewall 3.0 applications. Hence a dynamo DB table needs to be created and the name of table created should be passed on to vSRX Virtual Firewall 3.0.

Use the web console or the CLI to create the DynamoDB table. In the web console, you have an option to navigate to **DynamoDB->Tables** and create new table that stores the keys.

- b. Create IAM role to enable access for vSRX Virtual Firewall 3.0 instance.

KMS service is available for EC2 instances such as vSRX Virtual Firewall on AWS. As mentioned above once the DynamoDB table is created, for vSRX Virtual Firewall to use the service, IAM roles with access policies need to be enabled and bound to the instance. vSRX Virtual Firewall will also use Cloud Watch to log any events, hence policies to enable this service for instance are also needed.

These policies are minimum required to enable vSRX Virtual Firewall instance to use KMS service. Once the role is created, you can then attach this IAM role to the instance from GUI or using AWS CLI.

The IAM role should include the below access policies:

- **AWS Managed:**
  - AmazonS3ReadOnlyAccess
  - AmazonSSMReadOnlyAccess
  - CloudWatchFullAccess
- **Custom:**
  - DynamoDBTableFullAccess

Equivalent JSON:



```

{
  "Version": "2012-10-17",
  "Statement": [
    {
      "Sid": "VisualEditor0",
      "Effect": "Allow",
      "Action": "dynamodb:*",
      "Resource": "*"
    }
  ]
}

```

- KMSFullAccess

Equivalent JSON:

```

{
  "Version": "2012-10-17",
  "Statement": [
    {
      "Sid": "VisualEditor0",
      "Effect": "Allow",
      "Action": [
        "kms:GetPublicKey",
        "kms:Decrypt",
        "kms:TagResource",
        "kms:Encrypt",
        "kms:CreateKey",
        "kms:Sign"
      ],
      "Resource": "*"
    }
  ]
}

```

### 3. Attach IAM role to vSRX Virtual Firewall instance.

After creating the IAM role, attach it to the vSRX Virtual Firewall instance either from GUI or using AWS CLI.

To attach vSRX instance in web console, navigate to the instance. On the top corner of the web console, click **Actions** ? **Security** ? **Modify IAM role**. Attach the created IAM role. See [IAM roles for Amazon EC2](#).

4. Check HSM status using the `show security hsm status` command. This CLI output is updated to display DynamoDB being used along with HSM reachability, Master binding Key(MBK), and Master Encryption Key (MEK) status. Initially, the HSM status shows accessible as **No**.
5. For HSM service to be accessible, the vSRX instance must specify the DynamoDB table where the keys are stored. Specify the DynamoDB table using the request `security hsm set dynamo-db <name_of_the_dynamodb>` command.

When you run this command, the HSM status will change to accessible and the AWS dynamoDB will show the bounded dynamoDB table.

6. After enabling the KMS service, you need to specify the Master Encryption Key (MEK) using the request `security hsm master-encryption-password set plain-text-password` command on vSRX Virtual Firewall 3.0.

Once you specify the MEK, vSRX Virtual Firewall 3.0 creates the RSA 2048 key pair (MBK) in KMS and encrypts MEK using Master binding Key (MBK) in KMS. MEK is then used as a key for encrypting data at rest such as hash of configuration, private key pair files and master-password file, if present.

7. Change the Master Encryption Password.

If you want to change the master encryption password then you can run the request `security hsm master-encryption-password set plain-text-password` command from operational mode:

**NOTE:** It is recommended that no configuration changes are made while you are changing the master encryption password.

The system checks if the master encryption password is already configured. If master encryption password is configured, then you are prompted to enter the current master encryption password.

The entered master encryption password is validated against the current master encryption password to make sure these master encryption passwords match. If the validation succeeds, you will be prompted to enter the new master encryption password as plain text. You will be asked to enter the key twice to validate the password.

The system then proceeds to re-encrypt the sensitive data with the new master encryption password. You must wait for this process of re-encryption to complete before attempting to change the master encryption password again.

If the encrypted master encryption password file is lost or corrupted, the system will not be able to decrypt the sensitive data. The system can only be recovered by re-importing the sensitive data in clear text, and re-encrypting them.

## AWS Cloud Formation Templates

### IN THIS SECTION

- [Cloud Formation Template for DynamoDB | 403](#)
- [Cloud Formation Template to Create IAM Role | 404](#)

This topic provides you AWS Cloud Formation Templates (CFT). You can deploy these templates using AWS CLI or web console to create the DynamoDB table and the IAM roles using the CloudFormation service, by creating CloudFormation stacks for each as mentioned in this topic.

- To create a CloudFormation stack you can do one of the following:
  - **Deploy the CloudFormation stack using CLI-** Refer to the below YAML files and sample commands to create a CloudFormation stack.
  - Deploy using the Web console.
    - Navigate to **CloudFormation** ->**Create Stack**-> and click **Create template in designer**. There is an option at the bottom to select template and an option to select YAML format at the bottom right.
    - Paste the attached sample template and save it by clicking the **Save** option. You will be prompted to save the file in S3 bucket. After you save the template, the S3 bucket location is specified.
    - Copy the S3 bucket location paste it in **CloudFormation**-> **Create Stack**->**Template is ready**->**S3 URL**. Follow the prompts and click **Next** to create the stack. When you follow the prompts, enter the stack name given in the YAML file.

**NOTE:** If you are having problems deploying the template or creating DynamoDb table using AWS GUI, please contact your administrator and make sure your account has permissions. While creating DynamoDB, refer the guidelines at [Naming Rules and Data Types](#).

If you are using the below YAML files for creating CloudFormation stack through a web console, then ensure that you enter the stack name as mentioned in the YAML files after you specify the S3 URL and click next.

For example, in the IAM role YAML file, the name of DynamoDB stack created by the DynamoDB YAML file is referenced. If you provide an incorrect stack name, then that will cause errors while forming the CloudFormation stack.

```
Parameters:
libpkcs11awsDDBStackName:
Type: String
Default: libpkcs11aws-ddb
```

See [Cloud Formation Template for DynamoDB](#) for information on AWS Cloud formation templates for DynamoDB.

See [Cloud Formation Template to Create IAM Role](#) for information on AWS Cloud formation templates for creating IAM role.

### Cloud Formation Template for DynamoDB

Deploy this template by executing the AWS CLI command `aws cloudformation create-stack --stack-name libpkcs11aws-ddb --template-body file:/// $PWD/ddb_table.cfn.yaml`.

**NOTE:** The stack name and template body file in the CLI arguments must be mentioned as defined in the YAML file.

```
***** Start *****
AWSTemplateFormatVersion: '2010-09-09'
Description: "libpkcs11AWS DynamoDB Table Definition"
Parameters:
libpkcs11awsDDBTableName:
Type: String
Description: Name of DynamoDB Table
Default: libpkcs11aws
libpkcs11awsDDBGSIName:
Type: String
Description: Name of DynamoDB Handle GSI
Default: handle-index
Resources:
```

```

libpkcs11awsDDBTable:
Type: AWS::DynamoDB::Table
Properties:
TableName: !Ref libpkcs11awsDDBTableName
ProvisionedThroughput:
ReadCapacityUnits: "5"
WriteCapacityUnits: "5"
AttributeDefinitions:
- AttributeName: "uuid"
  AttributeType: "S"
- AttributeName: "handle"
  AttributeType: "N"
KeySchema:
- AttributeName: "uuid"
  KeyType: "HASH"
- AttributeName: "handle"
  KeyType: "RANGE"
GlobalSecondaryIndexes:
- IndexName: !Ref libpkcs11awsDDBGSIName
  ProvisionedThroughput:
  ReadCapacityUnits: "5"
  WriteCapacityUnits: "5"
  KeySchema:
- AttributeName: "handle"
  KeyType: "HASH"
  Projection:
  NonKeyAttributes: []
  ProjectionType: "ALL"
Outputs:
libpkcs11awsDDBTableArn:
Value: !GetAtt libpkcs11awsDDBTable.Arn
Export:
Name: !Sub '${AWS::StackName}:libpkcs11awsDDBTableArn'
***** End *****

```

## Cloud Formation Template to Create IAM Role

Deploy this template by executing the AWS CLI command `aws --profile saml cloudformation create-stack --stack-name libpkcs11aws-ddb --template-body file:/// $PWD/ddb_table.cfn.yaml`.

**NOTE:** The stack name and template body file in the CLI arguments must be mentioned as defined in the YAML file.

```

***** Start *****
  AWSTemplateFormatVersion: '2010-09-09'
Description: "libpkcs11AWS EC2 IAM Instance Role"
Parameters:
  libpkcs11awsDDBStackName:
    Type: String
    Default: libpkcs11aws-ddb
Resources:
  libpkcs11awsEC2Role:
    Type: AWS::IAM::Role
    Properties:
      RoleName: libpkcs11awsEC2Role
      Path: "/"
    ManagedPolicyArns:
      - "arn:aws:iam::aws:policy/CloudWatchFullAccess"
      - "arn:aws:iam::aws:policy/AmazonSSMReadOnlyAccess"
      - "arn:aws:iam::aws:policy/AmazonS3ReadOnlyAccess"
    AssumeRolePolicyDocument:
      Version: '2012-10-17'
      Statement:
        - Effect: Allow
      Principal:
        Service:
          - ec2.amazonaws.com
      Action:
        - sts:AssumeRole
    Policies:
      - PolicyName: "DynamoDBTableFullAccess"
    PolicyDocument:
      Version: "2012-10-17"
      Statement:
        - Effect: "Allow"
      Action:
        - "dynamodb:*"
    Resource:

```

```

- '*'
- PolicyName: "KMSFullAccess"
PolicyDocument:
Version: "2012-10-17"
Statement:
- Effect: "Allow"
Action:
- "kms:*"
Resource:
- '*'

libpkcs11awsEC2RoleIP:
DependsOn: libpkcs11awsEC2Role
Type: AWS::IAM::InstanceProfile
Properties:
Path: "/"
Roles:
- libpkcs11awsEC2Role
InstanceProfileName: libpkcs11awsEC2Role

***** End *****

```

## Configure vSRX Virtual Firewall Using the CLI

### IN THIS SECTION

- [Understand vSRX Virtual Firewall on AWS Preconfiguration and Factory Defaults | 406](#)
- [Add a Basic vSRX Virtual Firewall Configuration | 407](#)
- [Add DNS Servers | 410](#)
- [Add vSRX Virtual Firewall Feature Licenses | 410](#)

### Understand vSRX Virtual Firewall on AWS Preconfiguration and Factory Defaults

vSRX Virtual Firewall on AWS deploys with the following preconfiguration defaults:

- SSH access with the RSA key pair configured during the installation
- No password access allowed for SSH access

- The management (fxp0) interface is preconfigured with the AWS Elastic IP and default route

Starting in Junos OS Release 15.1X49-D80 and Junos OS Release 17.3R1, the following example summarizes the preconfiguration statements added to a factory-default configuration for vSRX Virtual Firewall on AWS instances:

```
set groups aws-default system root-authentication ssh-rsa "ssh-rsa XXXRSA-KEYXXXXX"
set groups aws-default system services ssh no-passwords
set groups aws-default system services netconf ssh
set groups aws-default system services web-management https system-generated-certificate
set groups aws-default interfaces fxp0 unit 0 family inet address aws-ip-address
set groups aws-default routing-options static route 0.0.0.0/0 next-hop aws-ip-address
set apply-groups aws-default
```

For Junos OS Release 15.1X49-D70 and earlier, the following example summarizes the preconfiguration statements added to a factory-default configuration for vSRX Virtual Firewall on AWS instances:

```
set system root-authentication ssh-rsa "ssh-rsa XXXRSA-KEYXXXXX"
set system services ssh no-passwords
set interfaces fxp0 unit 0 family inet address aws-ip-address
set routing-options static route 0.0.0.0/0 next-hop aws-ip-address
```



**CAUTION:** Do not use the `load factory-default` command on a vSRX Virtual Firewall AWS instance. The factory default configuration removes the AWS preconfiguration. If you must revert to factory default, ensure that you manually reconfigure AWS preconfiguration statements before you commit the configuration; otherwise, you will lose access to the vSRX Virtual Firewall instance.

## Add a Basic vSRX Virtual Firewall Configuration

You can either create a new configuration on vSRX Virtual Firewall or copy an existing configuration from another SRX or vSRX Virtual Firewall and load it onto your vSRX Virtual Firewall on AWS. Use the following steps to copy and load an existing configuration:

1. [Saving a Configuration File](#)
2. [Loading a Configuration File](#)

To configure a vSRX Virtual Firewall instance using the CLI:

1. Log in to the vSRX Virtual Firewall instance using SSH and start the CLI.



**NOTE:** Starting in Junos OS Release 17.4R1, the default user name has changed from root@ to ec2-user@.

```
ec2-user% cli
ec2-user@>
```

2. Enter configuration mode.

```
ec2-user@> configure
[edit]
ec2-user@#
```

3. Set the authentication method to log into the vSRX Virtual Firewall. You can specify a password by entering a cleartext password or an encrypted password. If you require a more robust level of authentication security, we recommend that you select an SSH public key string (DSA, ECDSA, or RSA).

```
ec2-user@# set system root-authentication ssh-rsa <public-key>
```

or

```
ec2-user@# set system root-authentication plain-text-password
New password: password
Retype new password: password
```

4. Optionally, enable passwords for SSH if you want to create password access for additional users.

```
ec2-user@# delete services ssh no-passwords
```

5. Configure the hostname.

```
ec2-user@# set system host-name host-name
```

- For each vSRX Virtual Firewall revenue interface, assign the IP address defined on AWS. For example:

```
ec2-user@# set interfaces ge-0/0/0 unit 0 family inet address 10.0.10.197/24
```

For multiple private addresses, enter a set command for each address. Do not assign the Elastic IP address.

- Specify a security zone for the public interface.

```
ec2-user@# set security zones security-zone untrust interfaces ge-0/0/0.0
```

- Specify a security zone for the private interface.

```
ec2-user@# set security security-zone trust interfaces ge-0/0/1.0
```

- Configure routing to add a separate virtual router and routing option for the public and private interfaces.

**NOTE:** We recommend putting the revenue (data) interfaces in routing instances as a best practice to avoid asymmetric traffic/routing, because fxp0 is part of the default (inet.0) table by default. With fxp0 as part of the default routing table, there might be two default routes needed: one for the fxp0 interface for external management access, and the other for the revenue interfaces for traffic access. Putting the revenue interfaces in a separate routing instance avoids this situation of two default routes in a single routing instance.

```
set routing-instances aws instance-type virtual-router
set routing-instances aws interface ge-0/0/0.0
set routing-instances aws interface ge-0/0/1.0
set routing-instances aws interface st0.1
set routing-instances aws routing-options static route 0.0.0.0/0 next-hop 10.0.0.1
set routing-instances aws routing-options static route 10.20.20.0/24 next-hop st0.1
```

- Verify the configuration.

```
ec2-user@# commit check
configuration check succeeds
```

11. Commit the configuration to activate it on the device.

```
ec2-user@# commit
commit complete
```

12. Optionally, use the `show` command to display the configuration to verify that it is correct.

For an example of how to configure vSRX Virtual Firewall to NAT all hosts behind the vSRX Virtual Firewall instance in the Amazon Virtual Private Cloud (Amazon VPC) to the IP address of the vSRX Virtual Firewall egress interface on the untrust zone, see *Example: Configuring NAT for vSRX*. This configuration allows hosts behind vSRX Virtual Firewall in a cloud network to access the Internet.

For an example of how to configure IPsec VPN between two instances of vSRX Virtual Firewall on AWS on different Amazon VPCs, see *Example: Configure VPN on vSRX Between Amazon VPCs*.

## Add DNS Servers

vSRX Virtual Firewall does not include any DNS servers in the default configuration. You might need DNS configured to deploy Layer 7 services, such as IPS, to pull down signature updates, for example. You can use your own external DNS server or use an AWS DNS server. If you enable DNS on your Amazon VPC, queries to the Amazon DNS server (169.254.169.253) or the reserved IP address at the base of the VPC network range plus two should succeed. See [AWS - Using DNS with Your Amazon VPC](#) for complete details.

## Add vSRX Virtual Firewall Feature Licenses

Certain Junos OS software features require a license to activate the feature. To enable a licensed feature, you need to purchase, install, manage, and verify a license key that corresponds to each licensed feature. To conform to software feature licensing requirements, you must purchase one license per feature per instance. The presence of the appropriate software unlocking key on your virtual instance allows you to configure and use the licensed feature.

See [Managing Licenses for vSRX](#) for details.

## RELATED DOCUMENTATION

[CLI User Guide](#)

[AWS - Using DNS with Your VPC](#)

## Configure vSRX Virtual Firewall Using the J-Web Interface

### IN THIS SECTION

- [Access the J-Web Interface and Configure vSRX Virtual Firewall | 411](#)
- [Apply the Configuration Settings for vSRX Virtual Firewall | 413](#)
- [Add vSRX Virtual Firewall Feature Licenses | 414](#)

### Access the J-Web Interface and Configure vSRX Virtual Firewall

To configure vSRX Virtual Firewall using the *J-Web* Interface:

1. Enter the AWS Elastic IP address of the eth0 interface in the browser Address box.
2. Specify the username and password.
3. Click **Log In**, and select the **Configuration Wizards** tab from the left navigation panel. The J-Web Setup Wizard page opens.
4. Click **Setup**.

You can use the Setup wizard to configure a device or edit an existing configuration.

- Select **Edit Existing Configuration** if you have already configured the wizard using the factory mode.
- Select **Create New Configuration** to configure a device using the wizard.

The following configuration options are available in the guided setup:

- Basic

Select **basic** to configure the device name and user account information as shown in [Table 76 on page 412](#).

- Device name and user account information

**Table 76: Device Name and User Account Information**

Field	Description
Device name	Type the name of the device. For example: <b>vSRX</b> .
Root password	Create a default root user password.
Verify password	Verify the default root user password.
Operator	<p>Add an optional administrative account in addition to the root account.</p> <p>User role options include:</p> <ul style="list-style-type: none"> <li>• <b>Superuser:</b> This user has full system administration rights and can add, modify, and delete settings and users.</li> <li>• <b>Operator:</b> This user can perform system operations such as a system reset but cannot change the configuration or add or modify users.</li> <li>• <b>Read only:</b> This user can only access the system and view the configuration.</li> <li>• <b>Disabled:</b> This user cannot access the system.</li> </ul>

- Select either **Time Server** or **Manual**. [Table 77 on page 412](#) lists the system time options.

**Table 77: System Time Options**

Field	Description
<b>Time Server</b>	
Host Name	Type the hostname of the time server. For example: <b>ntp.example.com</b> .
IP	Type the IP address of the time server in the IP address entry field. For example: <b>192.168.1.254</b> .

**NOTE:** You can enter either the hostname or the IP address.

Table 77: System Time Options (Continued)

Field	Description
<b>Manual</b>	
Date	Click the current date in the calendar.
Time	Set the hour, minute, and seconds. Choose <b>AM</b> or <b>PM</b> .
<b>Time Zone (mandatory)</b>	
Time Zone	Select the time zone from the list. For example: GMT Greenwich Mean Time GMT.

- Expert
  - a. Select **Expert** to configure the basic options as well as the following advanced options:
    - Four or more internal zones
    - Internal zone services
    - Application of security policies between internal zones
  - b. Click **Need Help** for detailed configuration information.

You see a success message after the basic configuration is complete.

## Apply the Configuration Settings for vSRX Virtual Firewall

To apply the configuration settings for vSRX Virtual Firewall:

1. Review and ensure that the configuration settings are correct, and click **Next**. The Commit Configuration page appears.
2. Click **Apply Settings** to apply the configuration changes to vSRX Virtual Firewall.
3. Check the connectivity to vSRX Virtual Firewall, because you might lose connectivity if you have changed the management zone IP. Click the URL for reconnection instructions on how to reconnect to the device.
4. Click **Done** to complete the setup.

After successful completion of the setup, you are redirected to the J-Web interface.



**CAUTION:** After you complete the initial setup, you can relaunch the J-Web Setup wizard by clicking **Configuration>Setup**. You can either edit an existing configuration or create a new configuration. If you create a new configuration, the current configuration in vSRX Virtual Firewall will be deleted.

## Add vSRX Virtual Firewall Feature Licenses

Certain Junos OS software features require a license to activate the feature. To enable a licensed feature, you need to purchase, install, manage, and verify a license key that corresponds to each licensed feature. To conform to software feature licensing requirements, you must purchase one license per feature per instance. The presence of the appropriate software unlocking key on your virtual instance allows you to configure and use the licensed feature.

See [Managing Licenses for vSRX](#) for details.

## Upgrade Junos OS Software on a vSRX Virtual Firewall Instance

### IN THIS SECTION

- [Upgrade the Junos OS for vSRX Virtual Firewall Software Release | 414](#)
- [Replace the vSRX Virtual Firewall Instance on AWS | 415](#)

This section outlines how to upgrade Junos OS software on your vSRX Virtual Firewall instance to a newer release. Depending upon your preference, you can replace the vSRX Virtual Firewall software in one of two ways:

### Upgrade the Junos OS for vSRX Virtual Firewall Software Release

You can directly upgrade the Junos OS for vSRX Virtual Firewall software using the CLI. Upgrading or downgrading Junos OS can take several hours, depending on the size and configuration of the network. You download the desired Junos OS Release for vSRX Virtual Firewall .tgz file from the [Juniper Networks website](#).

You also can upgrade using J-Web (see [J-Web](#)) or the Junos Space Network Management Platform (see [Junos Space](#)).

For the procedure on upgrading a specific Junos OS for vSRX Virtual Firewall software release, see the *Migration, Upgrade, and Downgrade Instructions* topic in the release-specific *vSRX Virtual Firewall Release Notes* available on the [vSRX TechLibrary](#).

## Replace the vSRX Virtual Firewall Instance on AWS

To replace a vSRX Virtual Firewall instance on AWS with a different software release:

1. Log in to the vSRX Virtual Firewall instance using SSH and start the CLI.

**NOTE:** Starting in Junos OS Release 17.4R1, the default user name has changed from root@ to ec2-user@.

```
ec2-user% cli
ec2-user@>
```

2. Enter configuration mode.

```
ec2-user@> configure
[edit]
ec2-user@#
```

3. Copy the existing Junos OS configuration from the vSRX Virtual Firewall. The contents of the current level of the statement hierarchy (and below) are saved, along with the statement hierarchy containing it.

**NOTE:** By default, the configuration is saved to a file in your home directory.

- See [Saving a Configuration File](#) for additional background information on saving a Junos OS configuration file.
- See [file copy](#) for information on how to copy files from one location to another location on the local device or to a location on a remote device that is reachable by the local device.

```
ec2-user@#save <filename>
[edit]
ec2-user@#
```



4. Remove the vSRX Virtual Firewall instance on AWS as described in *Remove a vSRX Instance on AWS*.
5. Once the vSRX Virtual Firewall instance on AWS has been successfully removed, define the specifics of a vSRX Virtual Firewall instance prior to launching it. See *Configure an Amazon Virtual Private Cloud for vSRX*.
6. Launch the vSRX Virtual Firewall image using the desired software version available from AWS Marketplace as described in *Launch a vSRX Instance on an Amazon Virtual Private Cloud*.
7. Load the previously copied Junos OS configuration file onto your new (upgraded) vSRX Virtual Firewall instance as described in [Loading a Configuration File](#).

## Remove a vSRX Virtual Firewall Instance on AWS

To remove a vSRX Virtual Firewall instance on AWS:

1. Log in to the AWS Management Console and select **Services > Compute > EC2 > Instances**.
2. Select the vSRX Virtual Firewall instance and select **Actions > Instance State > Terminate** to remove the instance.
3. In the dialog box, expand the section and select **Release associated Elastic IP**.
4. Click **Yes, Terminate**.

**NOTE:** See [Deleting Your VPC](#) to remove any unused VPCs from AWS.

## Geneve Flow Infrastructure on vSRX Virtual Firewall 3.0

### IN THIS SECTION

- [Overview | 417](#)
- [Enable Security Policies for Geneve Packet Flow Tunnel Inspection | 418](#)

This topic provides overview and configuration of Geneve flow infrastructure on vSRX Virtual Firewall 3.0.

## Overview

### IN THIS SECTION

- [Benefits of Geneve Flow Infrastructure Support | 418](#)

Generic Network Virtualization Encapsulation (Geneve) is a network encapsulation protocol developed by the Internet Engineering Task Force (IETF).

The Geneve protocol supports network virtualization use cases for data center environments. In such environments, the Geneve tunnels act as a backplane for the virtual network function (VNF) that runs on a cloud deployment—for example, an Amazon Web Services (AWS) or a VMware deployment.

Starting in Junos OS Release 23.1R1, vSRX Virtual Firewall 3.0—the current version of Juniper Networks® vSRX Virtual Firewall Virtual Firewall— supports Geneve flow infrastructure for Geneve tunnel packet processing. With this support, you can use vSRX Virtual Firewall 3.0 to:

With the Geneve flow infrastructure support, vSRX Virtual Firewall 3.0 can:

- Perform the functions of a transit router or a tunnel endpoint device in various cloud deployments.

For example, you can deploy vSRX Virtual Firewall 3.0 with the AWS Gateway Load Balancer (GWLB) service that uses the Geneve protocol encapsulation for transparent load balancing and packet routing.

- Encapsulate and de-encapsulate the received Geneve tunnel packets.
- Apply Layer 4 (L4) and Layer 7 (L7) services on the inner traffic.

vSRX Virtual Firewall 3.0 as a tunnel endpoint in any cloud deployment receives Geneve packets on its Layer 3 (L3) interface and forwards the packet (after inspection) to the same destination endpoint.

You must attach a policy with an inspection profile that determines the:

- Type of Geneve traffic that vSRX Virtual Firewall 3.0 processes.
- Policies that vSRX Virtual Firewall 3.0 applies on the inner traffic.

You can configure security policies that can intercept Geneve traffic. The policy must be attached with an inspection profile that dictates the type of Geneve traffic to be processed and policies to be applied on the inner traffic.

You can configure the regular security policy on vSRX Virtual Firewall 3.0 to apply L4 and L7 services on the inner traffic.

After receiving the L3 encapsulated traffic without any changes, vSRX Virtual Firewall 3.0:

1. De-encapsulates the received Geneve tunnel packets.
2. Analyzes the tunnel header.
3. Performs L4 and L7 inspection against the inner IP packet.
4. Encapsulates the traffic.
5. Forwards the traffic to the destination tunnel endpoint.

### Benefits of Geneve Flow Infrastructure Support

- Data encapsulation—Provides a framework to support tunneling for network virtualization.
- Multitenant Support—Provides a framework to support tunneling for network virtualization. Multitenant cloud providers such as AWS can perform transparent load balancing by using the Geneve protocol.
- Performs transparent routing of packets—GWLB and vSRX Virtual Firewall 3.0 exchange application traffic with each other using Geneve encapsulation, which allows GWLB to preserve the content of the original traffic.
- Health check—Vendors (for example AWS) can perform health probe over the Geneve tunnel to determine the status of virtual machines (VMs).

### Enable Security Policies for Geneve Packet Flow Tunnel Inspection

#### SUMMARY

Use this configuration to enable security policies on vSRX Virtual Firewall 3.0 for Geneve packet flow tunnel inspection.

#### IN THIS SECTION

- [Requirements | 419](#)
- [Overview | 419](#)
- [Configuration \(vSRX Virtual Firewall 3.0 as Tunnel Endpoint\) | 419](#)
- [Configuration \(vSRX Virtual Firewall 3.0 as Transit Router\) | 426](#)

With Geneve support on vSRX Virtual Firewall 3.0 instances, you can use vSRX3.0 to:

- Connect end points in a campus, data center, and public cloud environments and their branches.
- Secure these environments with embedded security.

## Requirements

This example uses the following hardware and software components:

- vSRX Virtual Firewall 3.0
- Junos OS Release 23.1R1

Before you begin:

- Make sure you understand how the Geneve protocol works.

## Overview

Geneve flow support on vSRX Virtual Firewall 3.0 instances provides large enterprises a common framework to manage their campus and data center networks. The Geneve-based architecture supports efficient Layer 3 (L3) and Layer 4 (L4) network connectivity by ensuring scalability, simplicity, and agility.

Using this configuration you can:

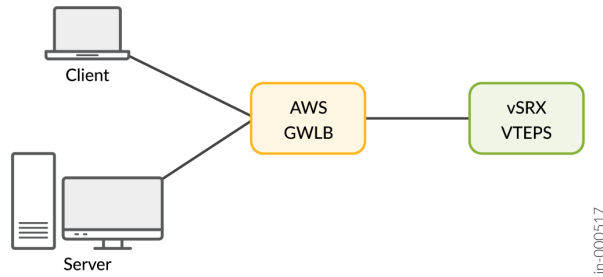
- Enable the security policies to process the Geneve tunnel encapsulated L3 packets.
- Create distinct profiles for Geneve traffic based on VNI and vendor TLV attributes-Policy once attached with an inspection profile dictates the type of Geneve traffic to be processed and policies to be applied to the inner traffic.
- Configure the regular security policy on vSRX Virtual Firewall 3.0 to apply L4 and L7 services on the inner traffic.

## Configuration (vSRX Virtual Firewall 3.0 as Tunnel Endpoint)

### IN THIS SECTION

- [Simplified Geneve Traffic Flow Topology with AWS GWLB and vSRX Virtual Firewall 3.0 as Tunnel Endpoint | 420](#)
- [CLI Quick Configuration | 420](#)
- [Procedure | 421](#)
- [Results | 422](#)
- [Verify Tunnel Inspection Profile and VNI | 424](#)
- [Verify Tunnel Inspection Profile and VNI | 425](#)

## *Simplified Geneve Traffic Flow Topology with AWS GWLB and vSRX Virtual Firewall 3.0 as Tunnel End-point*



### **CLI Quick Configuration**

To quickly configure this example, copy the following commands, paste them into a text file, remove any line breaks, change any details necessary to match your network configuration, copy and paste the commands into the CLI at the [edit] hierarchy level, and then enter `commit` from configuration mode.

**NOTE:** Define a trust and untrust zone to permit all host traffic.

```
set security tunnel-inspection inspection-profile ti-vendor geneve g-rule policy-set ps-vendor
set security tunnel-inspection inspection-profile ti-vendor geneve g-rule vni vni-vendor
set security tunnel-inspection vni vni-vendor vni-id 0

set security policies from-zone vtepc to-zone junos-host policy self match application junos-geneve
set security policies from-zone vtepc to-zone junos-host policy self match source-address any
set security policies from-zone vtepc to-zone junos-host policy self match destination-address any
set security policies from-zone vtepc to-zone junos-host policy self then permit tunnel-inspection ti-vendor
set security policies default-policy deny-all
set security policies policy-set ps-vendor policy self match source-address any
set security policies policy-set ps-vendor policy self match destination-address any
set security policies policy-set ps-vendor policy self match application any
set security policies policy-set ps-vendor policy self then permit
set interfaces ge-0/0/1 mtu 9000
set interfaces ge-0/0/1 unit 0 family inet address any
set interfaces ge-0/0/1 unit 0 family inet6 address any
```

## Procedure

### Step-by-Step Procedure

The following example requires you to navigate various levels in the configuration hierarchy. For instructions on how to do that, see *Using the CLI Editor in Configuration Mode* in the *Junos OS CLI User Guide*.

To configure Geneve flow support for tunnel inspection on vSRX Virtual Firewall 3.0:

1. Define a trust and untrust zone to permit all host traffic under the **[edit security zones]** hierarchy.
2. Define the tunnel-inspection profile.

```
[edit security tunnel-inspection]
user@host# set security tunnel-inspection inspection-profile ti-vendor geneve g-rule policy-
set ps-vendor

user@host# set security tunnel-inspection inspection-profile ti-vendor geneve g-rule vni vni-
vendor

user@host# set security tunnel-inspection vni vni-vendor vni-id 0
```

3. Define outer session policies to the outer packets and attach the referenced tunnel inspection profile

**NOTE:** In the policy configuration, the to-zone for the outer policy in case of vSRX Virtual Firewall 3.0 as tunnel endpoint must be junos-host, which is an inbuilt (reserved identifier) zone to process traffic.

```
[edit security policies]
user@host# set security policies from-zone vtepc to-zone junos-host policy self match source-
address any
user@host# set security policies from-zone vtepc to-zone junos-host policy self match
destination-address any
user@host# set security policies from-zone vtepc to-zone junos-host policy self match
application junos-geneve
user@host# set security policies from-zone vtepc to-zone junos-host policy self then permit
tunnel-inspection ti-vendor
user@host# set security policies default-policy deny-all
```

4. Define an inner policy under policy-set to process the decapsulated packet.

```
[edit security policies]
user@host# set security policies policy-set ps-vendor policy self match source-address any
user@host# set security policies policy-set ps-vendor policy self match destination-address
any
user@host# set security policies policy-set ps-vendor policy self match application any
user@host# set security policies policy-set ps-vendor policy self then permit
```

5. Configure the interface associated with from-zone of the virtual tunnel endpoint client (VTEPC) to receive the Geneve-encapsulated packets and the health-check packets.

```
[edit]
user@host# set interfaces ge-0/0/1 mtu 9000
user@host# set interfaces ge-0/0/1 unit 0 family inet address any
user@host# set interfaces ge-0/0/1 unit 0 family inet6 address any
```

### Results

From the configuration mode, confirm your configuration by entering the `show security policies` command. If the output does not display the intended configuration, repeat the instructions in this example to correct the configuration.

```
user@host# show security policies
```

```
from-zone trust to-zone untrust {
  policy p1 {
    match {
      source-address any;
      destination-address any;
      application any;
    }
    then {
      permit {
        application-services {
          application-traffic-control {
            rule-set ftp-test1;
          }
        }
      }
    }
  }
}
```

```
    }
  }
}
policy internet-access {
  match {
    source-address any;
    destination-address any;
    application any;
  }
  then {
    permit;
  }
}
}
from-zone untrust to-zone trust {
  policy dst-nat-pool-access {
    match {
      source-address any;
      destination-address 233.252.0.1/21;
      application any;
    }
    then {
      permit;
    }
  }
}
from-zone vtepc to-zone junos-host {
  policy self {
    match {
      source-address any;
      destination-address any;
      application junos-geneve;
    }
    then {
      permit {
        tunnel-inspection {
          ti-vendor;
        }
      }
    }
  }
}
}
```



```

policy-set ps-vendor {
  policy self {
    match {
      source-address any;
      destination-address any;
      application any;
    }
    then {
      permit;
    }
  }
}
default-policy {
  deny-all;
}

```

```

user@host# show security tunnel-inspection

```

```

inspection-profile ti-vendor {
  geneve g-rule {
    policy-set ps-vendor;
    vni vni-vendor;
  }
}
vni v1 {
  vni-id 0;
}
vni vni-vendor {
  vni-id 0;
}

```

After you complete configuring the feature on your device, enter `commit` from the configuration mode.

### ***Verify Tunnel Inspection Profile and VNI***

#### **Purpose**

Verify that you have configured the `tunnel-inspection` profile and the VXLAN network identifier (VNI).

## Action

From operational mode, enter the `show security tunnel-inspection profiles ti-vendor` and `show security tunnel-inspection vnis` commands.

```
user@host> show security tunnel-inspection profiles ti-vendor
```

```
-----  
Logical system: root-logical-system  
Profile count: 1  
Profile: ti-vendor  
Type: Geneve  
geneve count: 1  
geneve name: g-rule  
VNI count: 1  
VNI: vni-vendor  
Policy set: ps-vendor  
Inspection level: 1
```

```
user@host> show security tunnel-inspection vnis
```

```
-----  
Logical system: root-logical-system  
VNI count: 1  
VNI name: vni-vendor  
VNI id count: 0
```

## Meaning

The output displays that the Geneve tunnel-inspection profile is enabled and the VXLAN network identifier (VNI) is configured.

### *Verify Tunnel Inspection Profile and VNI*

## Purpose

Verify that you have configured the tunnel-inspection profile and the VXLAN network identifier (VNI).

## Action

From operational mode, enter the `show security tunnel-inspection profiles ti-vendor` and `show security tunnel-inspection vnis` commands.

```
user@host> show security tunnel-inspection profiles ti-vendor
```

```
-----  
Logical system: root-logical-system  
Profile count: 1  
Profile: ti-vendor  
Type: Geneve  
geneve count: 1  
geneve name: g-rule  
VNI count: 1  
VNI: vni-vendor  
Policy set: ps-vendor  
Inspection level: 1
```

```
user@host> show security tunnel-inspection vnis
```

```
-----  
Logical system: root-logical-system  
VNI count: 1  
VNI name: vni-vendor  
VNI id count: 0
```

## Meaning

The output displays that the Geneve tunnel-inspection profile is enabled and the VXLAN network identifier (VNI) is configured.

## Configuration (vSRX Virtual Firewall 3.0 as Transit Router)

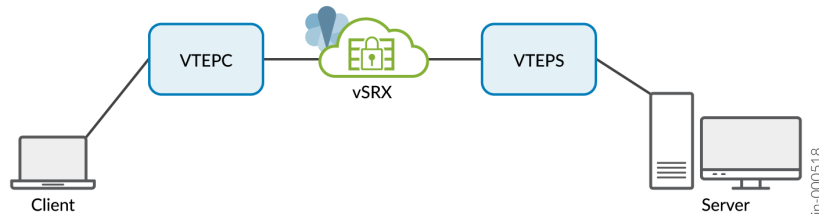
### IN THIS SECTION

- [Simplified Geneve Traffic Flow Topology vSRX Virtual Firewall 3.0 as Transit Router | 427](#)
- [CLI Quick Configuration | 427](#)
- [Procedure | 428](#)

### *Simplified Geneve Traffic Flow Topology vSRX Virtual Firewall 3.0 as Transit Router*

In this deployment mode the virtual tunnel endpoint client (vtepc) (Geneve tunnel endpoint) must ensure that packets destined to both the client and the server pass through virtual tunnel endpoint server (vteps) (vSRX Virtual Firewall 3.0). The source port is selected by the virtual tunnel endpoint (vtep).

**Figure 98: Simplified Topology of vSRX Virtual Firewall 3.0 as Transit Router**



### *CLI Quick Configuration*

To quickly configure this example, copy the following commands, paste them into a text file, remove any line breaks, change any details necessary to match your network configuration, copy and paste the commands into the CLI at the [edit] hierarchy level, and then enter `commit` from configuration mode.

```
set security tunnel-inspection vni r1 vni-range 1 to 100
set security tunnel-inspection vni r1 vni-id 500
set security tunnel-inspection profile inspection-profile ti-vendor geneve geneve1 vni r1
set security tunnel-inspection profile inspection-profile ti-vendor geneve geneve1 policy-set pset1
set security tunnel-inspection vni r2 vni-range 200 to 400
set security tunnel-inspection vni r2 vni-id 500
set security tunnel-inspection profile inspection-profile ti-vendor geneve geneve2 vni r2
set security tunnel-inspection profile inspection-profile ti-vendor geneve geneve2 policy-set pset2
set security policies from-zone vtepc to-zone vteps policy p1 match application junos-geneve

set security policies from-zone vtepc to-zone vteps policy p1 match source-address any
```

```

set security policies from-zone vtepc to-zone vsteps policy p1 match destination-address any

set security policies from-zone vtepc to-zone vsteps policy p1 then permit tunnel-inspection ti-vendor

set security policies from-zone vsteps to-zone vtepc policy p1 match application junos-geneve

set security policies from-zone vsteps to-zone vtepc policy p1 match source-address any

set security policies from-zone vsteps to-zone vtepc policy p1 match destination-address any

set security policies from-zone vsteps to-zone vtepc policy p1 then permit tunnel-inspection ti-vendor

set security policies default-policy deny-all

set security policies policy-set pset1 policy pset_p1 match source-address any
set security policies policy-set pset1 policy pset_p1 match destination-address any
set security policies policy-set pset1 policy pset_p1 match application any
set security policies policy-set pset1 policy pset_p1 then permit
set interfaces ge-0/0/1 mtu 9000
set interfaces ge-0/0/1 unit 0 family inet address any

set interfaces ge-0/0/1 unit 0 family inet6 address any

```

## Procedure

### Step-by-Step Procedure

The following example requires you to navigate various levels in the configuration hierarchy. For instructions on how to do that, see *Using the CLI Editor in Configuration Mode* in the *Junos OS CLI User Guide*.

To configure Geneve flow support for tunnel inspection on vSRX Virtual Firewall 3.0 (vSRX Virtual Firewall 3.0 as transit router) :

1. Define a trust and untrust zone to permit all host traffic under the **[edit security zones]** hierarchy.
2. Define the tunnel-inspection profile.

```

[edit security tunnel-inspection]
user@host# set security tunnel-inspection vni r1 vni-range 1 to 100
user@host# set security tunnel-inspection vni r1 vni-id 500

```

```

user@host# set security tunnel-inspection profile inspection-profile ti-vendor geneve geneve1
vni r1
user@host# set security tunnel-inspection profile inspection-profile ti-vendor geneve geneve1
policy-set pset1
user@host# set security tunnel-inspection vni r2 vni-range 200 to 400
user@host# set security tunnel-inspection vni r2 vni-id 500
user@host# set security tunnel-inspection profile inspection-profile ti-vendor geneve geneve2
vni r2
user@host# set security tunnel-inspection profile inspection-profile ti-vendor geneve geneve2
policy-set pset2

```

### 3. Define outer session policies.

**NOTE:** For vSRX Virtual Firewall 3.0 as transit router, you need two policies in each direction. The from-zone and to-zone are the respective zones that must be defined under the interfaces.

```

[edit security policies]
user@host# set security policies from-zone vtepc to-zone vteps policy p1 match source-address
any
user@host# set security policies from-zone vtepc to-zone vteps policy p1 match destination-
address any
user@host# set security policies from-zone vtepc to-zone vteps policy p1 match application
junos-geneve
user@host# set security policies from-zone vtepc to-zone vteps policy p1 then permit tunnel-
inspection ti-vendor
user@host# set security policies from-zone vteps to-zone vtepc policy p1 match application
junos-geneve
user@host# set security policies from-zone vteps to-zone vtepc policy p1 match source-address
any
user@host# set security policies from-zone vteps to-zone vtepc policy p1 match destination-
address any
user@host# set security policies from-zone vteps to-zone vtepc policy p1 then permit tunnel-
inspection ti-vendor
user@host# set security policies default-policy deny-all

```

### 4. Define an inner policy under policy-set to process the decapsulated packet.

```

[edit security policies]
user@host# set security policies policy-set pset1 policy pset_p1 match source-address any

```

```

user@host# set security policies policy-set pset1 policy pset_p1 match destination-address any
user@host# set security policies policy-set pset1 policy pset_p1 match application any
user@host# set security policies policy-set pset1 policy pset_p1 then permit

```

5. Configure the interface associated with `from-zone` of the virtual tunnel endpoint client (VTEPC) to receive the Geneve-encapsulated packets and the health-check packets.

**NOTE:** In case of transit mode, vSRX Virtual Firewall 3.0 must be configured with two L3 interfaces for ingress and egress.

```

[edit]
user@host# set interfaces ge-0/0/1 mtu 9000
user@host# set interfaces ge-0/0/1 unit 0 family inet address any
user@host# set interfaces ge-0/0/1 unit 0 family inet6 address any

```

### Results

From the configuration mode, confirm your configuration by entering the `show security policies` command. If the output does not display the intended configuration, repeat the instructions in this example to correct the configuration.

```

user@host# show security policies

```

```

from-zone trust to-zone untrust {
  policy p1 {
    match {
      source-address any;
      destination-address any;
      application any;
    }
    then {
      permit {
        application-services {
          application-traffic-control {
            rule-set ftp-test1;
          }
        }
      }
    }
  }
}

```

```
    }
  }
}
from-zone vtepc to-zone vteps {
  policy p1 {
    match {
      source-address any;
      destination-address any;
      application junos-geneve;
    }
    then {
      permit {
        tunnel-inspection {
          ti-vendor;
        }
      }
    }
  }
}
from-zone vteps to-zone vtepc {
  policy p1 {
    match {
      source-address any;
      destination-address any;
      application junos-geneve;
    }
    then {
      permit {
        tunnel-inspection {
          ti-vendor;
        }
      }
    }
  }
}
policy-set pset1 {
  policy pset_p1 {
    match {
      source-address any;
      destination-address any;
      application any;
    }
  }
}
```



```

        then {
            permit;
        }
    }
}
default-policy {
    deny-all;
}}

```

```
user@host# show security tunnel-inspection
```

```

inspection-profile ti-vendor {
    geneve g-rule {
        policy-set ps-vendor;
        vni vni-vendor;
    }
}
inspection-profile pro1;
vni r1 {
    vni-id 500;
}
vni r2 {
    vni-id 500;
}
}
}

```

After you complete configuring the feature on your device, enter `commit` from the configuration mode.

## SEE ALSO

[Geneve Flow Infrastructure on vSRX Virtual Firewall 3.0 | 416](#)

No Link Title

No Link Title

No Link Title

[AWS Gateway Load Balancing with Geneve | 433](#)

## AWS Gateway Load Balancing with Geneve

### IN THIS SECTION

- [Overview of AWS Gateway Load Balancer | 433](#)
- [AWS GWLB with Geneve vSRX Virtual Firewall 3.0 Deployment | 435](#)

## Overview of AWS Gateway Load Balancer

### IN THIS SECTION

- [Benefits of AWS Gateway Load Balancer Service | 434](#)

Amazon Web Services (AWS) Gateway Load Balancer (GWLB) is a networking service with various features that help you deploy third-party appliances. GWLB gives you a single gateway for distributing traffic across multiple virtual appliances. You can scale the virtual appliances up or down according to demand. These capabilities decrease potential points of failure in your network and increase availability. You can deploy vSRX Virtual Firewall 3.0 with the AWS Gateway Load Balancer (GWLB) service that uses the Geneve protocol encapsulation for transparent load balancing and packet routing.

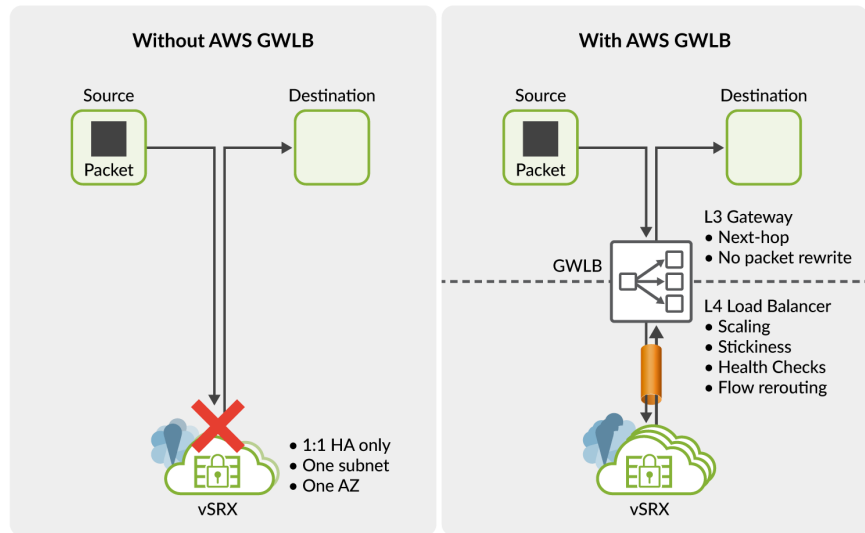
Using AWS GWLB, we can offer a number of managed services using vSRX Virtual Firewall 3.0 to AWS without having to separately solve for the availability, load balancing and cloud scaling for various solutions.

Starting in Junos OS Release 23.2R1, you can integrate vSRX Virtual Firewall 3.0 with AWS GWLB (with Geneve protocol support). vSRX Virtual Firewall 3.0 can decode and encode the AWS GWLB metadata and allows performing interoperability testing to identify the healthiest vSRX Virtual Firewall 3.0 in the AWS environment.

The traffic flow in AWS environment or solutions with Geneve flow support on vSRX Virtual Firewall 3.0 is as follows:

When traffic source is sending traffic to its destination and GWLB is deployed (using routing techniques), the GWLB operates as a Layer 3 (L3) gateway. The L3 characteristics of GWLB is, it can be a next hop in a route table with packet in packet out service and does not reroute a packet. .

Figure 99: AWS Gateway Load Balancer and vSRX Virtual Firewall 3.0



GWLB acts as a Layer 4 (L4) load balancer for the received traffic, enabling you to easily deploy, scale, and manage vSRX Virtual Firewall 3.0. Additionally, GWLB provides stickiness of flows in both the directions. This feature enables vSRX Virtual Firewall 3.0 to see and act on the traffic in both the directions.

GWLB can perform periodic health check on vSRX Virtual Firewall 3.0 to check whether any vSRX Virtual Firewall instance is down. If any vSRX Virtual Firewall instance is down, GWLB can reroute the flows by encapsulating the original traffic in a L3 header.

vSRX Virtual Firewall 3.0 receives the original traffic in a L3 encapsulation through the Geneve protocol. The L3 packet is received by vSRX Virtual Firewall 3.0 without any change in source IP or port numbers. vSRX Virtual Firewall 3.0 then:

- De-encapsulates the traffic.
- Looks at and inspects the traffic.
- Sends the traffic to its destination.

#### Benefits of AWS Gateway Load Balancer Service

- Improved virtual appliance availability—To ensure your virtual appliances are available and healthy, Gateway Load Balancer runs health checks to identify unhealthy virtual appliances.

When it detects an unhealthy virtual appliance, Gateway Load Balancer reroutes traffic away from that instance to a healthy one, so you experience graceful failover during both planned and unplanned down time.

- **Scale virtual appliances**—Gateway Load Balancer automatically scales your virtual appliances up or down, based on demand.
- **Cost effective**—With virtual appliances available with bring-your-own-license (BYOL) or pay-as-you-go pricing, you have the option to only pay for what you use, and reduce the cost by over provisioning.
- **Health check mechanisms**—Provides better health check mechanisms that use TCP, HTTP, or HTTPS. If in case there is an instance failure, these mechanisms help you identify the healthiest vSRX Virtual Firewall 3.0 instance and you can then reroute new flows.
- **Enables transparent insertion of services**—because the traffic is passing from GWLB to the appliances in a L3 encapsulation, the source and destination don't have to change any software. The appliances simply send the traffic as if there was no node in between.

## SEE ALSO

[Geneve Flow Infrastructure on vSRX Virtual Firewall 3.0 | 416](#)

## AWS GWLB with Geneve vSRX Virtual Firewall 3.0 Deployment

### IN THIS SECTION

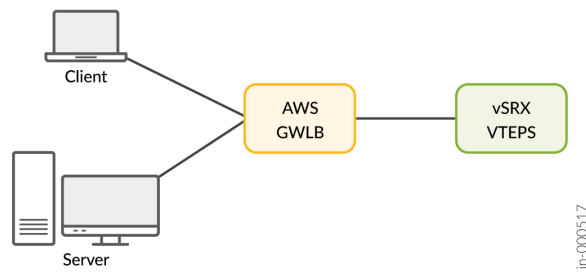
- [Overview | 435](#)
- [Deploy vSRX Virtual Firewall 3.0 as Tunnel Endpoint | 436](#)

### Overview

You can deploy vSRX Virtual Firewall 3.0 with AWS GWLB and Geneve flow support in two modes:

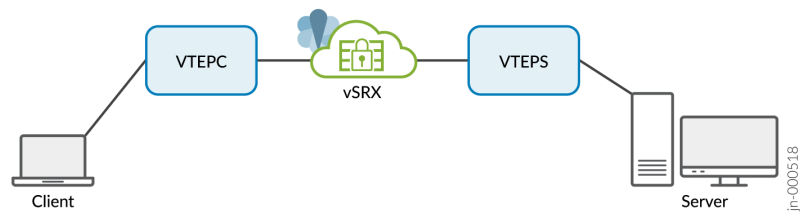
- **vSRX Virtual Firewall acts as a tunnel endpoint**—In this deployment mode, the virtual tunnel endpoint client (vtepc) (Geneve tunnel endpoint) must ensure that packets destined to both the client and the server pass through virtual tunnel endpoint server (vteps) (vSRX Virtual Firewall 3.0). The source port is selected by the virtual tunnel endpoint (vtep).

Figure 100: vSRX Virtual Firewall 3.0 as Tunnel Endpoint



- vSRX Virtual Firewall 3.0 as a transit router between Geneve tunnel endpoints.

Figure 101: vSRX Virtual Firewall 3.0 as Transit Router



### Deploy vSRX Virtual Firewall 3.0 as Tunnel Endpoint

With vSRX Virtual Firewall 3.0 as a tunnel endpoint for the traffic that is received by the GWLB in the security VPC supports encoding and decoding Geneve-related type-length-value (TLV) pairs and responds to the health check for the GWLB. This is a deployment scenario where you can launch vSRX Virtual Firewall in a security VPC with GWLB (AWS Gateway load balancer) and use the same deployment steps to launch vSRX Virtual Firewall based on your needs. The vSRX Virtual Firewall that is deployed in the security VPC must support the Geneve decapsulation, parsing header, encapsulate post inspection and forward the packet back to the AWS GWLB.

# Virtual Firewall in AWS Use Cases

## IN THIS CHAPTER

- [Example: Configuring NAT for vSRX Virtual Firewall | 437](#)
- [Example: Configure VPN on vSRX Virtual Firewall Between Amazon VPCs | 439](#)
- [Example: Configure Juniper ATP Cloud for vSRX Virtual Firewall | 445](#)

## Example: Configuring NAT for vSRX Virtual Firewall

### IN THIS SECTION

- [Before You Begin | 437](#)
- [Overview | 437](#)
- [Configuration | 438](#)
- [Configuring NAT | 438](#)

This example shows how to configure vSRX Virtual Firewall to NAT all hosts behind the vSRX Virtual Firewall instance in the Amazon Virtual Private Cloud (Amazon VPC) to the IP address of the vSRX Virtual Firewall egress interface on the untrust zone. This configuration allows hosts behind vSRX Virtual Firewall in a cloud network to access the Internet.

### Before You Begin

Ensure that you have installed and launched a vSRX Virtual Firewall instance in an Amazon VPC.

### Overview

A common cloud configuration includes hosts that you want to grant access to the Internet, but you do not want anyone from outside your cloud to get access to your hosts. You can use vSRX Virtual Firewall in an Amazon VPC to NAT traffic inside the Amazon VPC from the public Internet.

## Configuration

### Configuring NAT

#### IN THIS SECTION

- Procedure | 438

#### Procedure

#### Step-by-Step Procedure

To configure NAT on the vSRX Virtual Firewall instance:

1. Log in to the vSRX Virtual Firewall console in configuration edit mode (See *Configure vSRX Using the CLI*).
2. Set the IP addresses for vSRX Virtual Firewall revenue interfaces.

```
set interfaces ge-0/0/0 unit 0 family inet address 10.0.10.197/24
set interfaces ge-0/0/1 unit 0 family inet address 10.0.20.1/24
```

3. Set up the untrust security zone.

```
set security zones security-zone untrust host-inbound-traffic system-services https
set security zones security-zone untrust host-inbound-traffic system-services ssh
set security zones security-zone untrust interfaces ge-0/0/0.0
```

4. Set up the trust security zone.

```
set security zones security-zone trust host-inbound-traffic system-services https
set security zones security-zone trust host-inbound-traffic system-services ssh
set security zones security-zone trust host-inbound-traffic system-services ping
set security zones security-zone trust interfaces ge-0/0/1.0
```

## 5. Set up the security policies.

```
set security policies from-zone trust to-zone untrust policy test match source-address any
set security policies from-zone trust to-zone untrust policy test match destination-address
any
set security policies from-zone trust to-zone untrust policy test match application any
set security policies from-zone trust to-zone untrust policy test then permit
```

## 6. Configure NAT.

```
set security nat source rule-set SNAT_RuleSet from zone trust
set security nat source rule-set SNAT_RuleSet to zone untrust
set security nat source rule-set SNAT_RuleSet rule SNAT_Rule match source-address 0.0.0.0/0
set security nat source rule-set SNAT_RuleSet rule SNAT_Rule then source-nat interface
commit
```

## RELATED DOCUMENTATION

[vSRX Virtual Firewall-Based AWS Transit VPC](#)

[Day One: Amazon Web Services with vSRX Cookbook](#)

## Example: Configure VPN on vSRX Virtual Firewall Between Amazon VPCs

### IN THIS SECTION

- [Before You Begin | 440](#)
- [Overview | 440](#)
- [vSRX1 VPN Configuration | 440](#)
- [Verification | 444](#)



This example shows how to configure IPsec VPN between two instances of vSRX Virtual Firewall on different Amazon VPCs.

## Before You Begin

Ensure that you have installed and launched a vSRX Virtual Firewall instance in an Amazon VPCs.

See [SRX Site-to-Site VPN Configuration Generator](#) and [How to troubleshoot a VPN tunnel that is down or not active](#) for additional information.

## Overview

You can use IPsec VPN to secure traffic between two Amazon VPCs using two vSRX Virtual Firewall instances.

## vSRX1 VPN Configuration

### IN THIS SECTION

- Procedure | 440
- vSRX2 VPN Configuration | 442

## Procedure

### Step-by-Step Procedure

To configure IPsec VPN on vSRX1:

1. Log in to the vSRX1 console in configuration edit mode (See *Configure vSRX Using the CLI*).
2. Set the IP addresses for vSRX1 revenue interfaces.

```
set interfaces ge-0/0/0 unit 0 family inet address 10.0.0.10/24
set interfaces ge-0/0/1 unit 0 family inet address 10.10.10.10/24
set interfaces st0 unit 1 family inet address 10.0.250.10/24
```

3. Set up the untrust security zone.

```
set security zones security-zone untrust screen untrust-screen
set security zones security-zone untrust host-inbound-traffic system-services https
```

```

set security zones security-zone untrust host-inbound-traffic system-services ssh
set security security-zone untrust interfaces ge-0/0/0.0
set security security-zone untrust interfaces st0.1

```

#### 4. Set up the trust security zone.

```

set security zone trust host-inbound-traffic system-services https
set security zone trust host-inbound-traffic system-services ssh
set security zone trust host-inbound-traffic system-services ping
set security security-zone trust interfaces ge-0/0/1.0

```

#### 5. Configure IKE.

```

set security ike proposal AWS_IKE_Proposal authentication-method pre-shared-keys
set security ike proposal AWS_IKE_Proposal dh-group group2
set security ike proposal AWS_IKE_Proposal authentication-algorithm sha-256
set security ike proposal AWS_IKE_Proposal encryption-algorithm aes-256-cbc
set security ike proposal AWS_IKE_Proposal lifetime-seconds 1800
set security ike policy AWS-R mode aggressive
set security ike policy AWS-R proposals AWS_IKE_Proposal
set security ike policy AWS-R pre-shared-key ascii-text preshared-key
set security ike gateway AWS-R ike-policy AWS-R
set security ike gateway AWS-R address 198.51.100.10
set security ike gateway AWS-R local-identity user-at-hostname "source@example.net"
set security ike gateway AWS-R remote-identity user-at-hostname "dest@example.net"
set security ike gateway AWS-R external-interface ge-0/0/0

```

#### 6. Configure IPsec.

```

set security ipsec proposal AWS_IPSEC protocol esp
set security ipsec proposal AWS_IPSEC authentication-algorithm hmac-sha1-96
set security ipsec proposal AWS_IPSEC encryption-algorithm aes-256-cbc
set security ipsec policy AWS_IPSEC_POL proposals AWS_IPSEC
set security ipsec vpn aws-aws bind-interface st0.1
set security ipsec vpn aws-aws ike gateway AWS-R
set security ipsec vpn aws-aws ike ipsec-policy AWS_IPSEC_POL
set security ipsec vpn aws-aws establish-tunnels immediately

```

## 7. Configure routing.

```
set routing-instances aws instance-type virtual-router
set routing-instances aws interface ge-0/0/0.0
set routing-instances aws interface ge-0/0/1.0
set routing-instances aws interface st0.1
set routing-instances aws routing-options static route 0.0.0.0/0 next-hop 10.0.0.1
set routing-instances aws routing-options static route 10.20.20.0/24 next-hop st0.1
commit
```

## vSRX2 VPN Configuration

### Step-by-Step Procedure

To configure IPsec VPN on vSRX2:

1. Log in to the vSRX2 console in configuration edit mode (See *Configure vSRX Using the CLI*).
2. Set the IP addresses for the vSRX2 revenue interfaces.

```
set interfaces ge-0/0/0 unit 0 family inet address 10.1.0.10/24
set interfaces ge-0/0/1 unit 0 family inet address 10.20.20.10/24
set interfaces st0 unit 1 family inet address 10.0.250.20/24
```

3. Set up the untrust security zone.

```
set security zones security-zone untrust screen untrust-screen
set security zones security-zone untrust host-inbound-traffic system-services https
set security zones security-zone untrust host-inbound-traffic system-services ssh
set security zones security-zone untrust interfaces ge-0/0/0.0
set security zones security-zone untrust interfaces st0.1
```

4. Set up the trust security zone.

```
set security zones security-zone trust host-inbound-traffic system-services https
set security zones security-zone trust host-inbound-traffic system-services ssh
set security zones security-zone trust host-inbound-traffic system-services ping
set security zones security-zone trust interfaces ge-0/0/1.0
```

## 5. Configure IKE.

```

set security ike proposal AWS_IKE_Proposal authentication-method pre-shared-keys
set security ike proposal AWS_IKE_Proposal dh-group group2
set security ike proposal AWS_IKE_Proposal authentication-algorithm sha-256
set security ike proposal AWS_IKE_Proposal encryption-algorithm aes-256-cbc
set security ike proposal AWS_IKE_Proposal lifetime-seconds 1800
set security ike policy AWS-R mode aggressive
set security ike policy AWS-R proposals AWS_IKE_Proposal
set security ike policy AWS-R pre-shared-key ascii-text preshared-key
set security ike gateway AWS-R ike-policy AWS-R
set security ike gateway AWS-R address 203.0.113.10
set security ike gateway AWS-R local-identity user-at-hostname "dest@example.net"
set security ike gateway AWS-R remote-identity user-at-hostname "source@example.net"
set security ike gateway AWS-R external-interface ge-0/0/0

```

## 6. Configure IPsec.

```

set security ipsec proposal AWS_IPSEC protocol esp
set security ipsec proposal AWS_IPSEC authentication-algorithm hmac-sha1-96
set security ipsec proposal AWS_IPSEC encryption-algorithm aes-256-cbc
set security ipsec policy AWS_IPSEC_POL proposals AWS_IPSEC
set security ipsec vpn aws-aws bind-interface st0.1
set security ipsec vpn aws-aws ike gateway AWS-R
set security ipsec vpn aws-aws ike ipsec-policy AWS_IPSEC_POL
set security ipsec vpn aws-aws establish-tunnels immediately

```

## 7. Configure routing.

```

set routing-instances aws instance-type virtual-router
set routing-instances aws interface ge-0/0/0.0
set routing-instances aws interface ge-0/0/1.0
set routing-instances aws interface st0.1
set routing-instances aws routing-options static route 0.0.0.0/0 next-hop 10.0.0.1
set routing-instances aws routing-options static route 10.10.10.0/24 next-hop st0.1
commit

```

## Verification

### IN THIS SECTION

- [Verify Active VPN Tunnels | 444](#)

### Verify Active VPN Tunnels

#### Purpose

Verify that the tunnel is up on both vSRX Virtual Firewall instances on AWS.

#### Action

```
ec2-user@> show security ipsec security-associations
```

```
Total active tunnels: 1
```

```
ID      Algorithm          SPI      Life:sec/kb  Mon lsys Port  Gateway
<131074 ESP:aes--cbc--256/sha1 de836105 1504/ unlim -- root 4500 52.200.89.XXX
>131074 ESP:aes--cbc--256/sha1 b349bc84 1504/ unlim -- root 4500 52.200.89.XXX
```

**NOTE:** Starting in Junos OS Release 17.4R1, the default user name has changed from root@ to ec2-user@.

### RELATED DOCUMENTATION

---

[vSRX Virtual Firewall-Based AWS Transit VPC](#)

---

[Day One: Amazon Web Services with vSRX Cookbook](#)

---

[VPN Feature Guide for Security](#)

---

[Application Firewall Overview](#)

## Example: Configure Juniper ATP Cloud for vSRX Virtual Firewall

### IN THIS SECTION

- [Before You Begin | 445](#)
- [Overview | 445](#)
- [Juniper ATP Cloud Configuration | 445](#)

This example shows how to configure Juniper ATP Cloud on a vSRX Virtual Firewall instance that is deployed in a virtual private cloud (VPC).

### Before You Begin

Ensure that you have installed and launched a vSRX Virtual Firewall instance in a VPC.

### Overview

You can use Juniper ATP Cloud, a cloud-based solution, along with vSRX Virtual Firewall to protect all hosts in your network against evolving security threats.

### Juniper ATP Cloud Configuration

#### IN THIS SECTION

- [Procedure | 445](#)

### Procedure

#### Step-by-Step Procedure

To configure Juniper ATP Cloud on a vSRX Virtual Firewall instance:

1. Log in to the vSRX Virtual Firewall instance using SSH and start the CLI.

```
root% cli
root@>
```

2. Enter configuration mode.

```
root@> configure
[edit]
root@#
```

3. Set up the correct data interface for the active advanced antimalware (AAMW) service instead of using the default fxp0 interface.

```
root@# set services advanced-anti-malware connection source-interface ge-0/0/0.0
```

4. Configure NAT.

```
root@# set security nat source rule-set rs1 from zone trust
root@# set security nat source rule-set rs1 to zone untrust
root@# set security nat source rule-set rs1 rule r1 match source-address 0.0.0.0/0
root@# set security nat source rule-set rs1 rule r1 match destination-address 0.0.0.0/0
root@# set security nat source rule-set rs1 rule r1 then source-nat interface
```

5. Set up virtual routing instance for the correct data interface for AAMW service.

```
root@# set routing-instances vsrx-vr1 instance-type virtual-router
root@# set routing-instances vsrx-vr1 routing-options static route 0.0.0.0/0 next-hop 10.4.1.1
root@# set routing-instances vsrx-vr1 interface ge-0/0/0.0
root@# set routing-instances vsrx-vr1 interface ge-0/0/1.0
```

6. Verify the configuration.

```
root@# commit check
configuration check succeeds
```

7. Commit the configuration to activate it on the vSRX Virtual Firewall instance.

```
root@# commit
commit complete
```

8. Optionally, you can verify the configuration by running the following show commands in the configuration mode:

- show services advanced-anti-malware connection | display set
- show security nat | display set
- show routing-instances vsrx-vr1 | display set

## RELATED DOCUMENTATION

| [Juniper Advanced Threat Prevention Cloud Administration Guide](#)



# 7

PART

## vSRX Virtual Firewall Deployment for Microsoft Azure

---

[Overview | 449](#)

[Deploy vSRX Virtual Firewall from the Azure Portal | 461](#)

[Deploy vSRX Virtual Firewall from the Azure CLI | 493](#)

[Configure and Manage vSRX Virtual Firewall for Microsoft Azure | 509](#)

[Configure Azure Features on vSRX Virtual Firewall and Use Cases | 518](#)

---

# Overview

## IN THIS CHAPTER

- Understand vSRX Virtual Firewall with Microsoft Azure Cloud | 449
- Requirements for vSRX Virtual Firewall on Microsoft Azure | 453

## Understand vSRX Virtual Firewall with Microsoft Azure Cloud

### IN THIS SECTION

- vSRX Virtual Firewall with Microsoft Azure | 449
- | 452

This section presents an overview of vSRX Virtual Firewall as deployed in the Microsoft Azure cloud.

### vSRX Virtual Firewall with Microsoft Azure

Starting in Junos OS Release 15.1X49-D80 and Junos OS Release 17.3R1, you can deploy the vSRX Virtual Firewall to the Microsoft Azure Cloud. Microsoft Azure is Microsoft's application platform for the public cloud. It is an open, flexible, enterprise-grade cloud computing platform for building, deploying, and managing applications and services through a global network of Microsoft-managed data centers. It provides Software as a Service (SaaS), Platform as a Service (PaaS), and Infrastructure as a Service (IaaS) services. You place your virtual machines (VMs) onto Azure virtual networks, where the distributed and virtual networks in Azure help ensure that your private network traffic is logically isolated from traffic on other Azure virtual networks.

The Azure WALinuxAgent performs the provisioning job for the vSRX Virtual Firewall instances. When a new vSRX Virtual Firewall instance is deployed, the continued increasing size of the waagent log file might cause the vSRX Virtual Firewall to stop. If the vSRX Virtual Firewall is still operating, then delete the `/var/log/waagent.log` directly or run the `clear log waagent.log all` command to clear the log file.

Or you can run the `set groups azure-provision system syslog file waagent.log archive size 1m` and `set groups azure-provision system syslog file waagent.log archive files 10` commands to prevent the growing of the waagent logs. These configurations will cause the rotation of log of waagent with the size bigger than 1MB and set a maximum of 10 backups.

You can add a vSRX Virtual Firewall virtual security appliance to provide networking security features as an application instance within an Azure virtual network. The vSRX Virtual Firewall protects the workloads that run within the virtual network on the Microsoft Azure Cloud.

You can deploy the vSRX Virtual Firewall VM in Azure using the following deployment methods:

- **Azure Marketplace**—Deploy the vSRX Virtual Firewall VM from the Azure Marketplace. The Azure Marketplace provides you with different methods to deploy a vSRX Virtual Firewall VM in your virtual network. You can choose a customized solution template offered by Juniper Networks to automate the vSRX Virtual Firewall VM deployment based on specific use cases (for example, a security gateway). A solution template automates the dependencies associated with specific deployment use cases, such as VM settings, virtual network settings (such as multiple subsets for the management interface (fxp0) and two revenue (data) interfaces), and so on. Or, you can select the vSRX Virtual Firewall VM image and define the deployment settings and dependencies based on your specific networking requirements. Starting in Junos OS Release 15.1X49-D91 for vSRX Virtual Firewall, you can deploy the vSRX Virtual Firewall to Microsoft Azure Cloud from the Azure Marketplace.

Azure Marketplace also enables you to discover and subscribe to software that supports regulated workloads through Azure Marketplace for Azure Government Cloud (US).

- **Azure CLI**—Deploy the vSRX Virtual Firewall VM from the Azure CLI. You can customize the vSRX Virtual Firewall VM deployment settings and dependencies based on your network requirements in Microsoft Azure Cloud. To help automate and simplify the deployment of the vSRX Virtual Firewall VM in the Microsoft Azure virtual network, Juniper Networks provides a series of scripts, Azure Resource Manager (ARM) templates and parameter files, and configuration files in a GitHub repository.

**NOTE:** Starting in Junos OS Release 15.1X49-D80 and Junos OS Release 17.3R1, you can deploy the vSRX Virtual Firewall to Microsoft Azure Cloud from the Azure CLI.

In Microsoft Azure, you can host servers and services on the cloud as a pay-as-you-go (PAYG) or bring-your-own-license (BYOL) service.

**NOTE:** vSRX Virtual Firewall PAYG images do not require any Juniper Networks licenses.

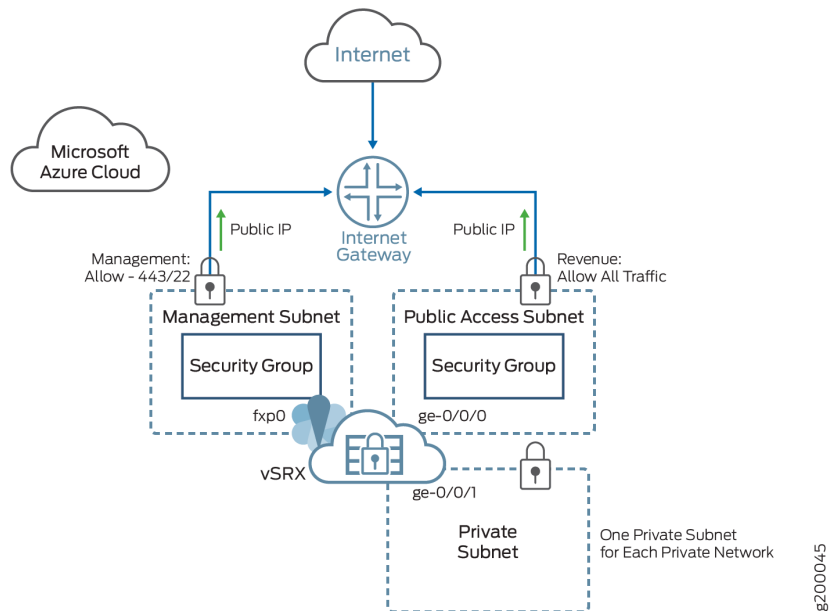
Starting in Junos OS Release 15.1X49-D120, vSRX Virtual Firewall on Microsoft Azure Cloud supports the vSRX Virtual Firewall Premium-Next Generation Firewall with Anti-Virus Protection bundle for PAYG, available as 1-hour or 1-year subscriptions. This bundle includes:

- Standard (STD) features of core security, including core firewall, IPsec VPN, NAT, CoS, and routing services.
- Advanced Layer 4 through 7 security services such as AppSecure features of AppID, AppFW, AppQoS, and AppTrack, IPS and rich routing capabilities, including the Content Security antivirus feature.

Figure 102 on page 451 illustrates the deployment of a vSRX Virtual Firewall in Microsoft Azure.

In the Microsoft Azure, public subnets have access to the Internet gateway, but private subnets do not. vSRX Virtual Firewall requires two public subnets and one or more private subnets for each individual instance group. The public subnets consist of one for the management interface (fxp0) and one for a revenue (data) interface. The private subnets, connected to the other vSRX Virtual Firewall interfaces, ensure that all traffic between applications on the private subnets and the Internet must pass through the vSRX Virtual Firewall instance.

**Figure 102: vSRX Virtual Firewall Deployed to Microsoft Azure**



For a glossary of Microsoft Azure terms see [Microsoft Azure glossary](#).

Starting in Junos OS Release 21.4R1, vSRX Virtual Firewall 3.0 supports Azure Accelerated Networking (AAN) option that utilizes the Mellanox SR-IOV virtual function for high-speed networking.

Microsoft Azure has Azure Accelerated Networking (AAN) option for each attached network interface. The AAN utilizes the Mellanox SR-IOV virtual function for high-speed networking. vSRX Virtual Firewall 3.0 now supports AAN. vSRX Virtual Firewall 3.0 with AAN provides better network performance at Azure cloud.

We currently support only the below listed vSRX Virtual Firewall 3.0 instances for Azure AAN.

**Table 78: vSRX Virtual Firewall 3.0 Instances Supported for AAN**

Size	vCPU	Memory (GiB)	MAX NICs
Standard_D8ds_v4	8	32	4
Standard_D16ds_v4	16	64	8
Standard_D32ds_v4	32	128	8

- Use the `az network nic update --name <interface-name> --resource-group <resource-group> --accelerated-networking true` command to enable AAN.
- Using the Web GUI: After you login to the Microsoft Azure portal:
  - Click **Virtual networks** and select the correct virtual network. `networking`
    - Click **Connected devices**, select the required NIC interface and then click **Enable accelerated networking**.
  - Click **Virtual machines** and select the required VM, then click **Networking**. Finally, click the pane of correct NIC interface and click **Enable accelerated networking**.

For more information see [Enabling Accelerated Networking for replicated VMs](#).

#### Release History Table

Release	Description
15.1X49-D91	Starting in Junos OS Release 15.1X49-D91 for vSRX Virtual Firewall, you can deploy the vSRX Virtual Firewall to Microsoft Azure Cloud from the Azure Marketplace.
15.1X49-D80	Starting in Junos OS Release 15.1X49-D80 and Junos OS Release 17.3R1, you can deploy the vSRX Virtual Firewall to the Microsoft Azure Cloud.

15.1X49-D80	Starting in Junos OS Release 15.1X49-D80 and Junos OS Release 17.3R1, you can deploy the vSRX Virtual Firewall to Microsoft Azure Cloud from the Azure CLI.
15.1X49-D120	Starting in Junos OS Release 15.1X49-D120, vSRX Virtual Firewall on Microsoft Azure Cloud supports the vSRX Virtual Firewall Premium-Next Generation Firewall with Anti-Virus Protection bundle for PAYG, available as 1-hour or 1-year subscriptions.

## RELATED DOCUMENTATION

[Microsoft Azure](#)

[Azure Virtual Networks](#)

[Microsoft Azure portal overview](#)

## Requirements for vSRX Virtual Firewall on Microsoft Azure

### IN THIS SECTION

- [System Requirements for vSRX Virtual Firewall on Microsoft Azure Cloud | 453](#)
- [Network Requirements for vSRX Virtual Firewall on Microsoft Azure Cloud | 456](#)
- [Microsoft Azure Instances and vSRX Virtual Firewall Instance Types | 456](#)
- [Interface Mapping for vSRX Virtual Firewall on Microsoft Azure | 457](#)
- [vSRX Virtual Firewall Default Settings on Microsoft Azure | 458](#)
- [Best Practices for Improving vSRX Virtual Firewall Performance | 459](#)

This section presents an overview of requirements for deploying a vSRX Virtual Firewall instance on Microsoft Azure Cloud.

### System Requirements for vSRX Virtual Firewall on Microsoft Azure Cloud

Starting in Junos OS Release 15.1X49-D80 and Junos OS Release 17.3R1, you can deploy the vSRX Virtual Firewall to the Microsoft Azure Cloud. Microsoft Azure supports a wide variety of sizes and options for deployed Azure virtual machines (VMs).

For the vSRX Virtual Firewall deployment in Microsoft Azure, we recommend DSv2-series VMs. The DSv2-series VMs provided from Microsoft Azure use Premium Storage(SSD) and are ideal for applications that demand faster CPUs and better local disk performance, or have higher memory demands. Of the available DSv2-series VMs, we recommend that you select Standard\_DS3\_v2, Standard\_DS4\_v2, or Standard\_DS5\_v2 for the vSRX Virtual Firewall VM deployment in Microsoft Azure. For more details, see [DSv2-series](#).

[Table 79 on page 454](#) lists the properties of the Standard\_DS3\_v2 VM available in Microsoft Azure.

**Table 79: Properties of the Standard\_DS3\_v2 VM in Microsoft Azure**

Component	Specification
Size	Standard_DS3_v2
CPU cores	4
Memory	14 GiB
Maximum number of data disks	16
Maximum cached and local disk storage throughput: IOPS/MBps (cache size in GB)	16,000/128 (172)
Maximum uncached disk throughput: IOPS/MBps	12,800/192
Max NICs/Expected network bandwidth (Mbps)	4/3000

[Table 80 on page 454](#) lists the properties of the Standard\_DS4\_v2 VM available in Microsoft Azure.

**Table 80: Properties of the Standard\_DS4\_v2 VM in Microsoft Azure**

Component	Specification
Size	Standard DS4_v2
CPU cores	8

**Table 80: Properties of the Standard\_DS4\_v2 VM in Microsoft Azure (Continued)**

Component	Specification
Memory	28 GiB
Maximum number of data disks	32
Temp storage (SSD) GiB	56
Max cached and temp storage throughput: IOPS/MBps (cache size in GiB)	32000/256 (344)
Max uncached disk throughput: IOPS/MBps	25600/384
Max NICs/Expected network bandwidth (Mbps)	8/6000

**NOTE:** The vSRX Virtual Firewall does not provide support for a high availability configuration in Microsoft Azure. In addition, the vSRX Virtual Firewall does not support Layer 2 transparent mode in Microsoft Azure.

[Table 81 on page 455](#) lists the properties of the Standard\_DS5\_v2 VM available in Microsoft Azure.

**Table 81: Properties of the Standard\_DS5\_v2 VM in Microsoft Azure**

Component	Specification
Size	Standard DS5_v2
CPU cores	16
Memory	56 GiB
Maximum number of data disks	64



**Table 81: Properties of the Standard\_DS5\_v2 VM in Microsoft Azure (Continued)**

Component	Specification
Temp storage (SSD) GiB	112
Max cached and temp storage throughput: IOPS/MBps (cache size in GiB)	64000/512 (688)
Max uncached disk throughput: IOPS/MBps	51200/768
Max NICs/Expected network bandwidth (Mbps)	8/12000

## Network Requirements for vSRX Virtual Firewall on Microsoft Azure Cloud

When you deploy a vSRX Virtual Firewall VM in a Microsoft Azure virtual network, note the following specifics of the deployment configuration:

- A dual public IP network configuration is a requirement for vSRX Virtual Firewall VM network connectivity; the vSRX Virtual Firewall VM requires two public subnets and one or more private subnets for each instance group.
- The public subnets required by the vSRX Virtual Firewall VM consist of one subnet for the out-of-band management interface (fxp0) for management access and another for the two revenue (data) interfaces. By default, one interface is assigned to the untrust security zone and the other to the trust security zone on the vSRX Virtual Firewall VM.
- In the Microsoft Azure deployment of the vSRX Virtual Firewall VM, the vSRX Virtual Firewall supports the management interface (fxp0) and the two revenue (data) interfaces (port ge-0/0/0 and ge-0/0/1), which includes public IP address mapping and data traffic forwarding to and from the vSRX Virtual Firewall VM.

## Microsoft Azure Instances and vSRX Virtual Firewall Instance Types

Microsoft Azure instance types supported for vSRX Virtual Firewall are listed in [Table 82 on page 457](#).

**Table 82: Supported Microsoft Azure Instance Types for vSRX Virtual Firewall**

Instance Type	vSRX Virtual Firewall Type	vCPUs	Memory in Instance Type (GB)	RSS Type
Standard_DS3_v2	vSRX Virtual Firewall-4CPU-14G memory	4	14	HWRSS
Standard_DS4_v2	vSRX Virtual Firewall-8CPU-28G memory	8	28	HWRSS
Standard_DS5_v2	vSRX Virtual Firewall-16CPU-56G memory	16	56	HWRSS

### Interface Mapping for vSRX Virtual Firewall on Microsoft Azure

[Table 83 on page 457](#) lists the vSRX Virtual Firewall and Microsoft Azure interface names. The first network interface is used for the out-of-band management (fxp0) for vSRX Virtual Firewall.

**Table 83: vSRX Virtual Firewall and Microsoft Azure Interface Names**

Interface Number	vSRX Virtual Firewall Interface	Microsoft Azure Interface
1	fxp0	eth0
2	ge-0/0/0	eth1
3	ge-0/0/1	eth2
4	ge-0/0/2	eth3
5	ge-0/0/3	eth4

**Table 83: vSRX Virtual Firewall and Microsoft Azure Interface Names (Continued)**

Interface Number	vSRX Virtual Firewall Interface	Microsoft Azure Interface
6	ge-0/0/4	eth5
7	ge-0/0/5	eth6
8	ge-0/0/6	eth7

**NOTE:** Refer [Dv2](#) and [DSv2-series](#) for information on maximum number of NICs supported per Azure instance type.

We recommend putting revenue interfaces in routing instances as a best practice to avoid asymmetric traffic/routing, because fxp0 is part of the default (inet.0) table by default. With fxp0 as part of the default routing table, there might be two default routes needed: one for the fxp0 interface for external management access, and the other for the revenue interfaces for traffic access. Putting the revenue interfaces in a separate routing instance avoids this situation of two default routes in a single routing instance. Ensure that interfaces belonging to the same security zone are in the same routing instance.

## vSRX Virtual Firewall Default Settings on Microsoft Azure

vSRX Virtual Firewall requires the following basic configuration settings:

- Interfaces must be assigned IP addresses.
- Interfaces must be bound to zones.
- Policies must be configured between zones to permit or deny traffic.

[Table 84 on page 458](#) lists the factory-default settings for security policies on the vSRX Virtual Firewall

**Table 84: Factory-Default Settings for Security Policies**

Source Zone	Destination Zone	Policy Action
trust	untrust	permit

**Table 84: Factory-Default Settings for Security Policies (Continued)**

Source Zone	Destination Zone	Policy Action
trust	trust	permit



**CAUTION:** Do not use the `load factory-default` command on the vSRX Virtual Firewall instance in Microsoft Azure. The factory-default configuration removes the “azure provision” preconfiguration. This group contains critical system-level settings and route information for the vSRX Virtual Firewall. A misconfiguration in the group “azure-provision” may result in the possible loss of connectivity to vSRX Virtual Firewall from Microsoft Azure. If you must revert to factory default, ensure that you first manually reconfigure the Microsoft Azure preconfiguration statements before you commit the configuration; otherwise, you will lose access to the vSRX Virtual Firewall instance. We strongly recommend that when you commit a configuration, perform an explicit `commit confirmed` to avoid the possibility of losing connectivity to vSRX Virtual Firewall. Once you have verified that the change works correctly, you can keep the new configuration active by entering the `commit` command within 10 minutes. Without the timely second confirm, configuration changes will be rolled back. See *Configure vSRX Using the CLI* for preconfiguration details.

## Best Practices for Improving vSRX Virtual Firewall Performance

Review the following deployment practices to improve vSRX Virtual Firewall performance:

- Disable the source/destination check for all vSRX Virtual Firewall interfaces.
- Limit public key access permissions to 400 for key pairs.
- Ensure that there are no contradictions between Microsoft Azure security groups and your vSRX Virtual Firewall configuration.
- Use vSRX Virtual Firewall NAT to protect your instances from direct Internet traffic.

### Release History Table

Release	Description
15.1X49-D80	Starting in Junos OS Release 15.1X49-D80 and Junos OS Release 17.3R1, you can deploy the vSRX Virtual Firewall to the Microsoft Azure Cloud.

## RELATED DOCUMENTATION

[KB Article - Interface must be in the same routing instance as the other interfaces in the zone](#)

---

[Windows virtual machines in Azure](#)

# Deploy vSRX Virtual Firewall from the Azure Portal

## IN THIS CHAPTER

- [Before You Deploy vSRX Virtual Firewall from the Azure Portal | 461](#)
- [Create a Resource Group | 462](#)
- [Create a Storage Account | 466](#)
- [Create a Virtual Network | 471](#)
- [Deploy the vSRX Virtual Firewall Image from Azure Marketplace | 476](#)

## Before You Deploy vSRX Virtual Firewall from the Azure Portal

You can deploy a vSRX Virtual Firewall virtual security appliance and its advanced security features in your virtual network directly from the Azure portal. This method provides a browser-based user interface for creating and configuring virtual machines and all related resources.

The Azure Marketplace provides you with different methods to deploy a vSRX Virtual Firewall virtual machine (VM) in a virtual network. You can choose a customized solution template offered by Juniper Networks in the Azure Marketplace to automate the vSRX Virtual Firewall deployment based on a specific use case (for example, a security gateway).

Solution templates allow the bundling of multiple Azure services and a software image into a template that enables you to quickly deploy a preconfigured solution. You access vSRX Virtual Firewall solution templates from the Azure Marketplace to simplify the end-to-end configuration steps involved in deploying a vSRX Virtual Firewall VM in your Azure virtual network. A solution template automates the dependencies associated with specific deployment use cases, such as VM settings, virtual network settings (such as multiple subnets for the management interface (fxp0) and two revenue (data) interfaces), and so on.

A vSRX Virtual Firewall solution template is based on a custom Microsoft Azure Resource Manager (ARM) template. The ARM template consists of JavaScript Object Notation (JSON) expressions that construct specific values for your vSRX Virtual Firewall deployment. To integrate with the Azure portal, each solution template uses **mainTemplate.json** and **createUiDefinition.json** files to define the components of the customized solution template for vSRX Virtual Firewall VM deployment.

You also have the option to select the vSRX Virtual Firewall image from Azure Marketplace and customize the vSRX Virtual Firewall VM deployment settings and dependencies based on your network requirements in Microsoft Azure Cloud. This deployment approach might be required if you have a vSRX Virtual Firewall VM deployment scenario that is outside of the use cases offered in the vSRX Virtual Firewall VM solution templates available from Juniper Networks.

Before you deploy the vSRX Virtual Firewall virtual security appliance from the Azure Marketplace:

- Review the requirements for deploying a vSRX Virtual Firewall VM in Microsoft Azure Cloud in *Requirements for vSRX on Microsoft Azure*.
- Obtain an account for and a subscription to Microsoft Azure (see [Microsoft Azure](#)).
- Use your Microsoft account username and password to log into the [Microsoft Azure portal](#).
- Purchase a vSRX Virtual Firewall license or request an evaluation license. Licenses can be procured from the [Juniper Networks License Management System \(LMS\)](#).
- Ensure that your Azure subscription includes the following for your vSRX Virtual Firewall VM:
  - Resource group, as described in *Create a Resource Group*.
  - Storage account, as described in *Create a Storage Account*.
  - Virtual network, as described in *Create a Virtual Network*.

## RELATED DOCUMENTATION

[Microsoft Azure portal](#)

[Microsoft Azure portal overview](#)

## Create a Resource Group

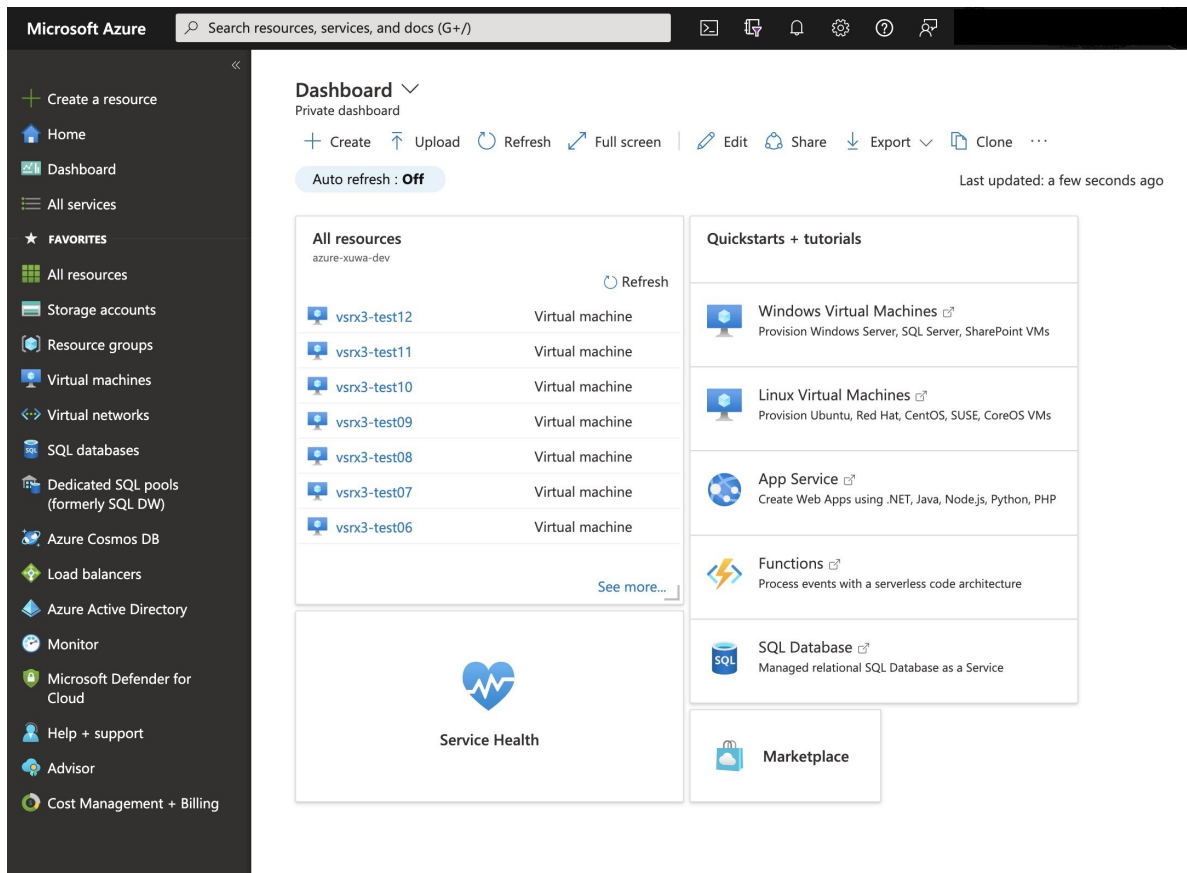
A resource group contains the resources required to successfully deploy a vSRX Virtual Firewall VM in Azure. It is a container that holds related resources for an Azure solution. In Azure, you logically group related resources such as storage accounts, virtual networks, and virtual machines (VMs) to deploy, manage, and maintain them as a single entity.

If you do not have an existing resource group in your subscription, then follow the steps outlined in this procedure.

To create a resource group in Azure:

1. Log in to the [Microsoft Azure portal](#) using your Microsoft account username and password. The Dashboard appears in the Azure portal (see [Figure 103 on page 463](#)). You see a unified dashboard for all your assets in Azure. Verify that the dashboard includes all subscriptions to which you currently have access, and all resource groups and associated resources.

**Figure 103: Microsoft Azure Portal Dashboard**



2. Click **Resource groups** from the menu of services to access the Resource Groups blade (see [Figure 104 on page 464](#)). You will see all the resource groups in your subscription listed in the blade.



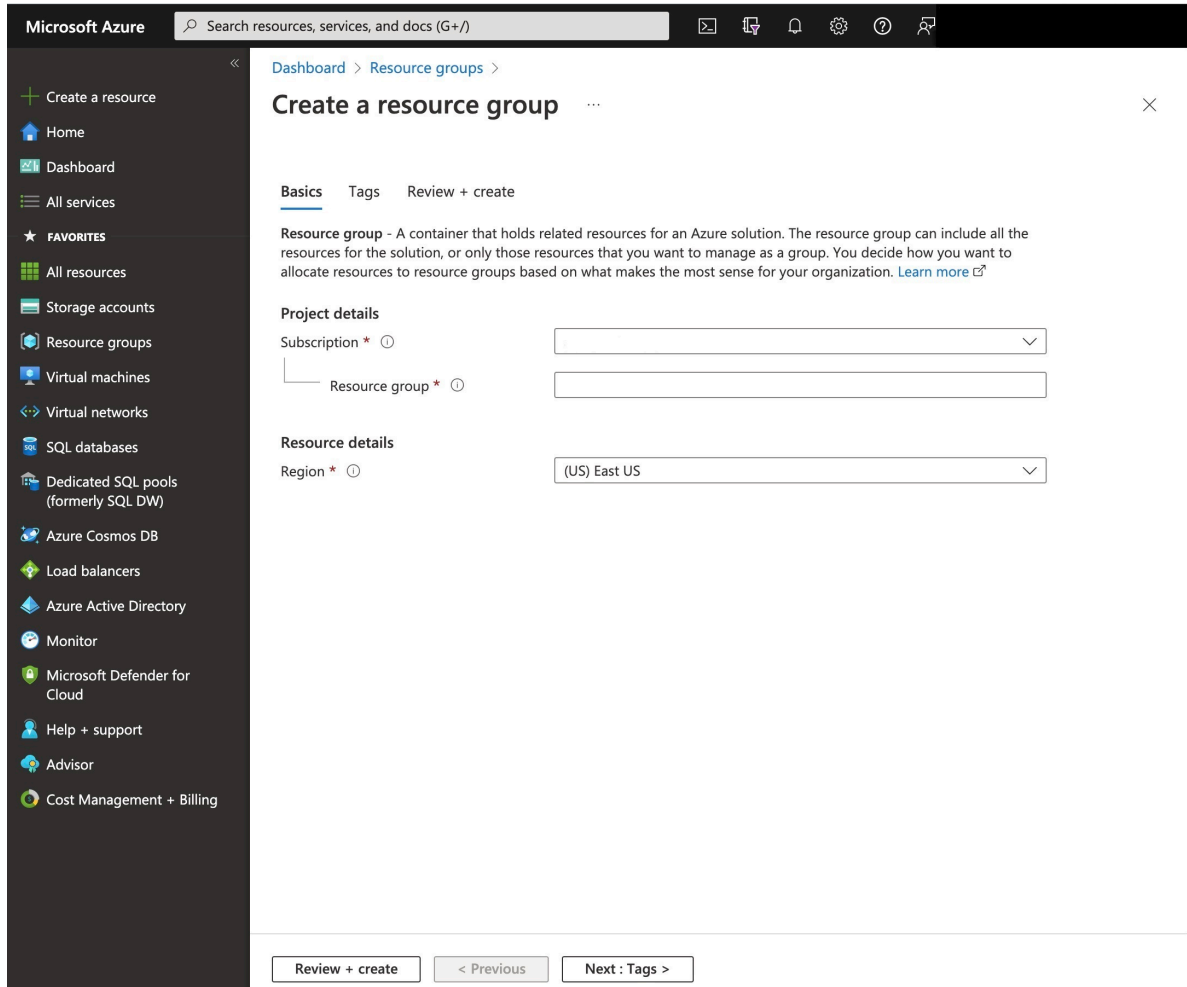
Figure 104: Resource Groups

The screenshot shows the Microsoft Azure portal interface. The left sidebar contains navigation options such as 'Create a resource', 'Home', 'Dashboard', 'All services', and 'FAVORITES'. The main content area is titled 'Resource groups' and includes a search bar, a 'Create' button, and a 'Manage view' dropdown. Below this, there are filters for 'Subscription equals' and 'Add filter'. A table lists resource groups with columns for 'Name', 'Subscription', and 'Location'. The table shows 18 records, all located in 'West US'. At the bottom, there is a pagination control showing 'Page 1 of 1' and 'Showing 1 to 18 of 18 records'.

Name	Subscription	Location
juniper-vsrx		West US
NetworkWatcherRG		West US
vsrx3-01		West US
vsrx3-02		West US
vsrx3-03		West US
vsrx3-04		West US
vsrx3-11		West US
vsrx3-12		West US
vsrx3-aan-07-d8dsv4		West US
vsrx3-aan-08-d16dsv4		West US
vsrx3-aan-09-d8dsv4-ipsec		West US
vsrx3-aan-10-d16dsv4-ipsec		West US
		West US
		West US
		West US
		West US

- click **Add (+)** to create a new resource group. The Create Resource Group blade appears (see [Figure 105](#) on page 465).

Figure 105: Creating a Resource Group



4. Provide the following information for the new resource group.

Parameter	Description
Resource Group Name	Enter a unique name for your new resource group. A resource group name can include alphanumeric characters, periods (.), underscores (_), hyphens (-), and parenthesis (), but the name cannot end with a period.
Subscription	Select your Microsoft Azure subscription.

*(Continued)*

Parameter	Description
Resource Group Location	Select the location of the Microsoft Azure data center from which you intend to deploy the vSRX Virtual Firewall VM. Specify a location where the majority of your resources will reside. Typically, select the location that is closest to your physical location.

5. Click **Create**. The resource group might take a few seconds to create. Once it is created, you see the resource group on the Azure portal dashboard.

## RELATED DOCUMENTATION

[Azure Resource Manager overview](#)

[Deploy resources with Resource Manager templates and Azure portal](#)

[Manage Azure resources through portal](#)

## Create a Storage Account

An Azure storage account provides a unique namespace to store and access your Azure storage data objects. All objects in a storage account are billed together as a group. By default, the data in your account is available only to the account owner.

If you do not have an existing storage account in your subscription, follow the steps outlined in this procedure.

To create a storage account in Azure:

1. Log in to the [Microsoft Azure portal](#) using your Microsoft account username and password. The Dashboard appears in the Azure portal (see [Figure 106 on page 467](#)). You see a unified dashboard for all your assets in Azure. Verify that the dashboard includes all subscriptions to which you currently have access, and all resource groups and associated resources.

Figure 106: Microsoft Azure Portal Dashboard

The screenshot displays the Microsoft Azure Portal Dashboard. At the top, there is a search bar and navigation icons. The left sidebar contains a navigation menu with options like 'Create a resource', 'Home', 'Dashboard', 'All services', and 'FAVORITES'. The main dashboard area is titled 'Dashboard' and includes a 'Private dashboard' section with actions like '+ Create', 'Upload', 'Refresh', 'Full screen', 'Edit', 'Share', 'Export', and 'Clone'. Below this, there is an 'Auto refresh: Off' indicator and a 'Last updated: a few seconds ago' timestamp. The dashboard is divided into several sections: 'All resources' (listing virtual machines like vsrx3-test12 to vsrx3-test06), 'Quickstarts + tutorials' (listing services like Windows Virtual Machines, Linux Virtual Machines, App Service, Functions, and SQL Database), and 'Service Health'.

2. Click **Storage Accounts** from the menu of services to access the Storage Accounts blade (see [Figure 107](#) on page 468).

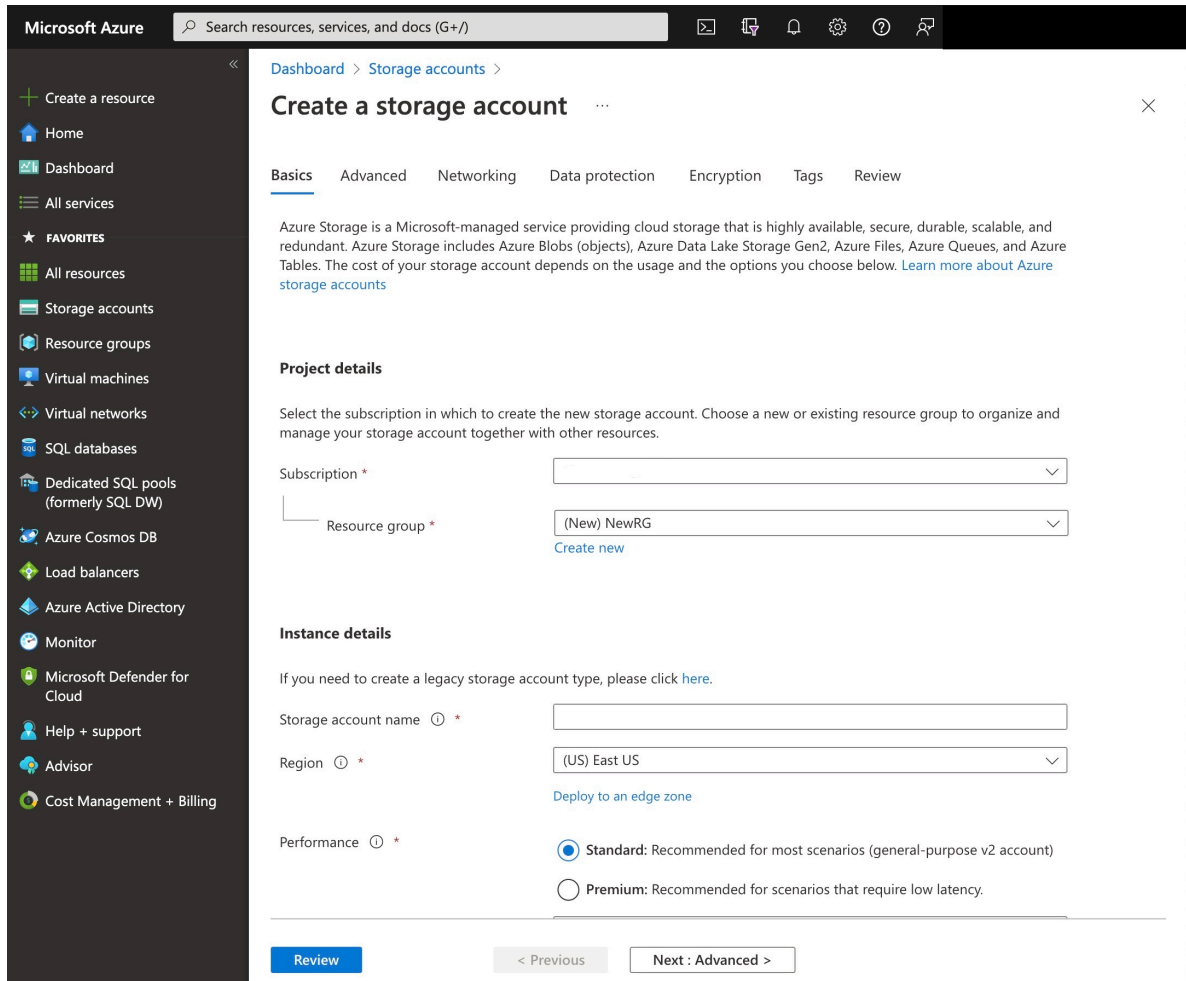
Figure 107: Azure Portal Storage Accounts

The screenshot displays the Azure portal interface for managing storage accounts. The left sidebar shows navigation options like 'Home', 'Dashboard', and 'Storage accounts'. The main content area shows a list of storage accounts with the following columns: Name, Type, Kind, Resource group, and Location. The table contains 16 records, all of which are 'Storage account' type and 'Storage' kind, located in 'West US'. The resource groups vary, including 'vsrx3-aan-10-d16dsv4...', 'vsrx3-01', 'vsrx3-02', 'vsrx3-03', 'vsrx3-04', 'vsrx3-05', 'vsrx3-06', 'vsrx3-aan-07-d8dsv4', 'vsrx3-aan-08-d16dsv4', 'vsrx3-aan-09-d8dsv4-i...', 'vsrx3-11', and 'vsrx3-12'. At the top of the list, there are buttons for '+ Create', 'Restore', 'Manage view', 'Refresh', 'Export to CSV', 'Open query', 'Assign tags', and 'Delete'. A filter bar at the top of the table shows 'Subscription equals' and an 'Add filter' button. At the bottom, there is a pagination control showing 'Page 1 of 1' and 'Showing 1 to 16 of 16 records', along with a 'Give feedback' link.

Name	Type	Kind	Resource group	Location
	Storage account	Storage		West US
vsrx2sa10	Storage account	Storage	vsrx3-aan-10-d16dsv4...	West US
	Storage account	Storage		West US
	Storage account	Storage		West US
vsrx3sa01	Storage account	Storage	vsrx3-01	West US
vsrx3sa02	Storage account	Storage	vsrx3-02	West US
vsrx3sa03	Storage account	Storage	vsrx3-03	West US
vsrx3sa04	Storage account	Storage	vsrx3-04	West US
vsrx3sa05	Storage account	Storage		West US
vsrx3sa06	Storage account	Storage		West US
vsrx3sa07	Storage account	Storage	vsrx3-aan-07-d8dsv4	West US
vsrx3sa08	Storage account	Storage	vsrx3-aan-08-d16dsv4	West US
vsrx3sa09	Storage account	Storage	vsrx3-aan-09-d8dsv4-i...	West US
vsrx3sa11	Storage account	Storage	vsrx3-11	West US
vsrx3sa12	Storage account	Storage	vsrx3-12	West US
	Storage account	Storage		West US

- Click **Add (+)** to create a new storage account. The Create Storage Account blade appears (see [Figure 108](#) on page 469).

Figure 108: Creating a Storage Account



4. Provide the following information for the new storage account.

Parameter	Description
Name	Enter a unique name for your new storage account. A storage account name can contain only lowercase letters and numbers, and must be between 3 and 24 characters.
Deployment Model	Select <b>Resource Manager</b> as the deployment model.

*(Continued)*

Parameter	Description
Account Kind	<p>Select the type of storage account: <b>General purpose</b> or <b>Blob storage</b>. The default is <b>General purpose</b>.</p> <ul style="list-style-type: none"> <li>• If General Purpose was selected, then specify the performance tier: <b>Standard</b> or <b>Premium</b>. The default is Standard.</li> <li>• If Blob storage was selected, then specify the access tier: <b>Hot</b> or <b>Cool</b>. The default is Hot.</li> </ul>
Performance	Select the type of performance: <b>Standard</b> or <b>Premium</b> . The default is <b>Standard</b> .
Replication	Select the replication option for the storage account: <b>Locally redundant storage (LRS)</b> , <b>Geo-redundant storage (GRS)</b> , <b>Read-access geo-redundant storage (RA-GRS)</b> , or <b>Zone-redundant storage (ZRS)</b> . The default is RA-GRS.
Storage Service Encryption	Enable or disable this option to protect your data at rest. Azure Storage encrypts data as written in an Azure datacenter, and decrypts that data once it is accessed. The default is Disabled.
Secure Transfer Required	Enable or disable this option to enhance the security of your storage account by allowing requests to the storage account by HTTPS only. The default is Disabled.
Subscription	Select your Microsoft Azure subscription.
Resource Group	Select an existing resource group or create a new one (see <i>Create a Resource Group</i> ).
Location	Select the Azure data center geographic region in which you are deploying the vSRX Virtual Firewall VM. Typically, select the location that is closest to your physical location.

5. Click **Create**. The storage account might take a few seconds to create. Once it is created, you see the storage account on the Azure portal dashboard.

## RELATED DOCUMENTATION

[Introduction to Microsoft Azure Storage](#)

[About Azure storage accounts](#)

## Create a Virtual Network

The Azure Virtual Network service enables you to securely connect Azure resources to each other with virtual networks. A virtual network is a representation of your own network in the cloud. It is a logical isolation of the Azure cloud dedicated to your subscription. You can also connect virtual networks to your on-premises network.

If you do not have an existing Azure virtual network, follow the steps outlined in this procedure.

To create an Azure virtual network:

1. Log in to the [Microsoft Azure portal](#) using your Microsoft account user name and password. The Dashboard appears in the Azure portal (see [Figure 109 on page 472](#)). You will see a unified dashboard for all your assets in Azure. Verify that the dashboard includes all subscriptions to which you currently have access, and all resource groups and associated resources.



Figure 109: Microsoft Azure Portal Dashboard

The screenshot displays the Microsoft Azure Portal Dashboard. The top navigation bar includes the Microsoft Azure logo, a search bar, and various utility icons. The left sidebar lists navigation options: 'Create a resource', 'Home', 'Dashboard', 'All services', 'FAVORITES', 'All resources', 'Storage accounts', 'Resource groups', 'Virtual machines', 'Virtual networks', 'SQL databases', 'Dedicated SQL pools (formerly SQL DW)', 'Azure Cosmos DB', 'Load balancers', 'Azure Active Directory', 'Monitor', 'Microsoft Defender for Cloud', 'Help + support', 'Advisor', and 'Cost Management + Billing'. The main content area is titled 'Dashboard' and shows a 'Private dashboard' with a search bar and a list of actions: '+ Create', 'Upload', 'Refresh', 'Full screen', 'Edit', 'Share', 'Export', and 'Clone'. Below this, there is an 'Auto refresh: Off' indicator and a timestamp 'Last updated: a few seconds ago'. The dashboard is divided into several sections: 'All resources' (listing virtual machines vsrx3-test06 through vsrx3-test12), 'Service Health' (with a heart icon), and 'Quickstarts + tutorials' (listing Windows Virtual Machines, Linux Virtual Machines, App Service, Functions, and SQL Database). A 'Marketplace' tile is also visible at the bottom right.

2. Click **Virtual Networks** from the menu of services to access the Virtual Networks blade (see [Figure 110 on page 473](#)).

Figure 110: Azure Portal Virtual Networks

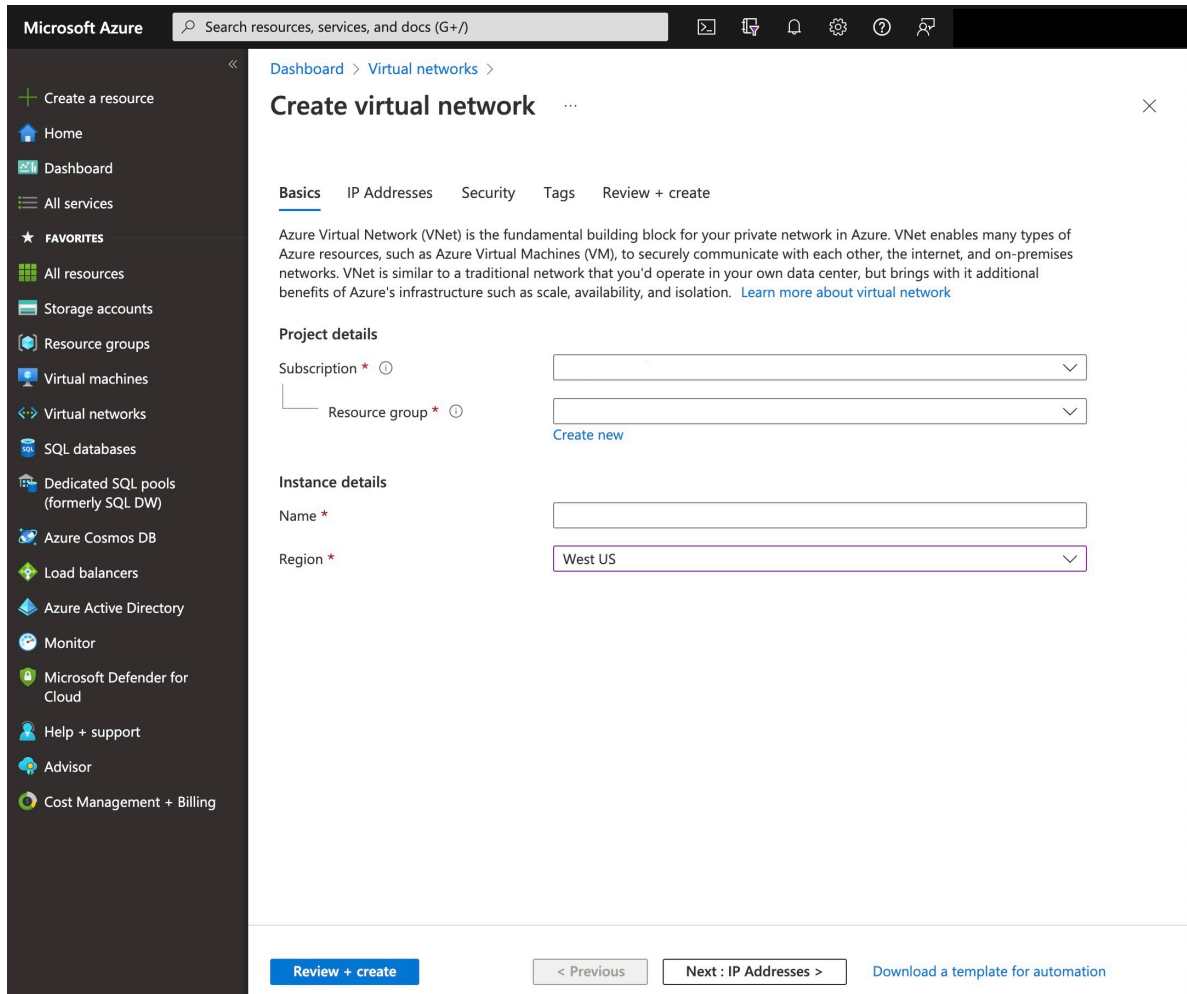
The screenshot shows the Azure Portal interface for managing Virtual Networks. The main content area displays a table of virtual networks. The table has the following columns: Name, Resource group, Location, and Subscription. The table contains 15 records, with the third record, 'vnet-vsrx3-test03', highlighted. The left sidebar shows the navigation menu with options like 'Create a resource', 'Home', 'Dashboard', and 'Virtual networks'. The top navigation bar includes a search bar and utility icons.

Name	Resource group	Location	Subscription
<>		West US	
<>		West US	
<> vnet-vsrx3-test01	vsrx3-01	West US	
<> vnet-vsrx3-test02	vsrx3-02	West US	
<> vnet-vsrx3-test03	vsrx3-03	West US	
<> vnet-vsrx3-test04	vsrx3-04	West US	
<>		West US	
<> vnet-vsrx3-test07	vsrx3-aan-07-d8dsv4	West US	
<> vnet-vsrx3-test08	vsrx3-aan-08-d16dsv4	West US	
<> vnet-vsrx3-test09	vsrx3-aan-09-d8dsv4-ip...	West US	
<> vnet-vsrx3-test10	vsrx3-aan-10-d16dsv4-i...	West US	
<> vnet-vsrx3-test11	vsrx3-11	West US	
<> vnet-vsrx3-test12	vsrx3-12	West US	
<>		West US	

Page 1 of 1 Showing 1 to 15 of 15 records. [Give feedback](#)

3. Click **Add (+)** to create a new virtual network. The Create Virtual Network blade appears (see [Figure 111 on page 474](#)).

Figure 111: Creating a Virtual Network



4. Provide the following information for the new virtual network.

Parameter	Description
Name	Enter a unique name for your new virtual network. The virtual network name must begin with a letter or number, end with a letter, number, or underscore, and the name may contain only letters, numbers, underscore, periods, or hyphens.
Address Space	Enter the virtual network's address range in CIDR notation. By default, the address range is 10.0.0.0/24.  <b>NOTE:</b> Ensure that the address space does not overlap with an existing network.

*(Continued)*

Parameter	Description
Subnet name	Enter a unique name for the subnet of the Azure virtual network. The subnet name must begin with a letter or number, end with a letter, number, or underscore, and the name may contain only letters, numbers, underscore, periods, or hyphens.
Subnet Address Range	<p>Enter a network subnet address range in CIDR notation. It must be contained by the address space of the virtual network, as defined in the Address Space field. Subnet address ranges cannot overlap one another. By default, the address range is 10.0.0.0/24.</p> <p>The subnet is a range of IP addresses in your virtual network to isolate VMs. Public subnets have access to the Internet gateway, but private subnets do not.</p> <p><b>NOTE:</b> The address range of a subnet that is already in use cannot be edited.</p>
Subscription	Select your Microsoft Azure subscription.
Resource Group	Select an existing resource group or create a new one (see <i>Create a Resource Group</i> ).
Location	Select the Azure data center geographic region in which you are deploying the vSRX Virtual Firewall VM. Typically, select the location that is closest to your physical location.

5. Click **Create**. The virtual network might take a few seconds to create. Once it is created, you will see the virtual network on the Azure portal dashboard.

## RELATED DOCUMENTATION

[Virtual networks and Windows virtual machines in Azure](#)

[Create a virtual network](#)

[Create, change, or delete network interfaces](#)

[Create a VM \(Classic\) with multiple NICs](#)

## Deploy the vSRX Virtual Firewall Image from Azure Marketplace

### IN THIS SECTION

- [Deploy the vSRX Virtual Firewall Image | 476](#)
- [Verify Deployment of vSRX Virtual Firewall to Microsoft Azure | 489](#)
- [Log In to a vSRX Virtual Firewall VM | 490](#)

Starting in Junos OS Release 15.1X49-D91 for vSRX Virtual Firewall, you can deploy the vSRX Virtual Firewall virtual security appliance in your Azure virtual network by selecting the vSRX Virtual Firewall image from Azure Marketplace and customizing the vSRX Virtual Firewall VM deployment settings and dependencies based on your network requirements in Microsoft Azure Cloud.

This deployment approach might be needed if you have a vSRX Virtual Firewall VM deployment scenario that is outside of the use cases offered in the vSRX Virtual Firewall VM solution templates available from Juniper Networks.

**NOTE:** Be sure you have an account for and a subscription to Microsoft Azure before deploying the vSRX Virtual Firewall to Azure (see [Microsoft Azure](#)).

If you do not have an Azure subscription, then you can create a free account before you begin. See the [Microsoft Azure website](#) for more details.

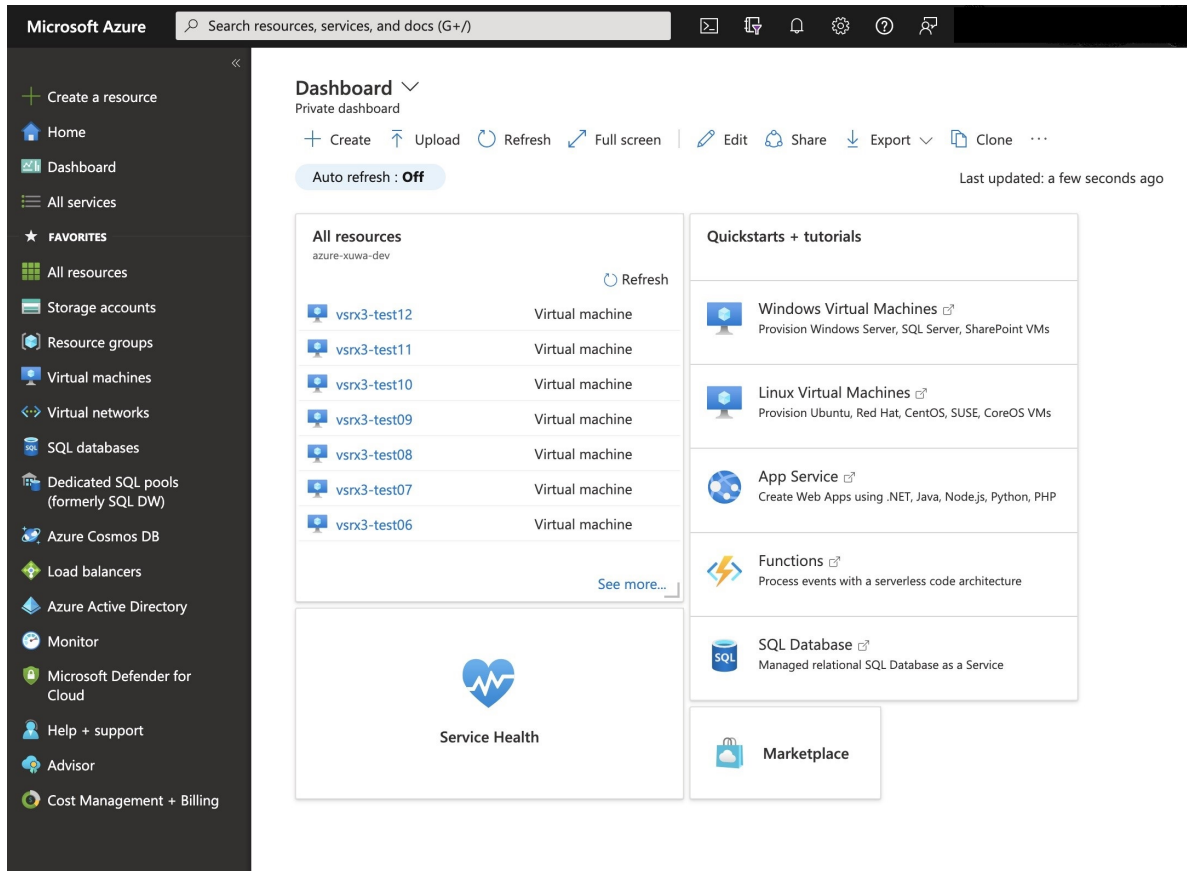
Use the following procedures to deploy and configure a vSRX Virtual Firewall VM into an Azure virtual network from the Azure portal.

### Deploy the vSRX Virtual Firewall Image

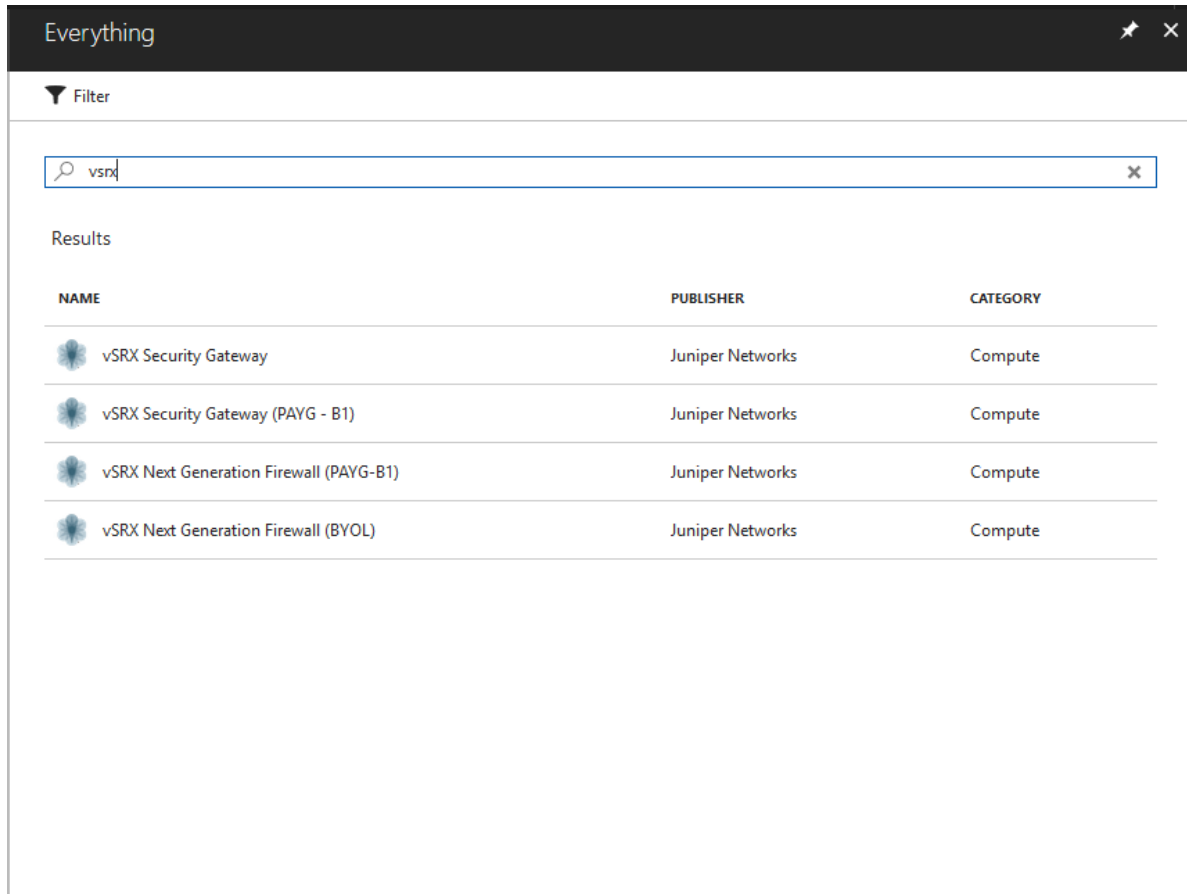
To deploy and configure a vSRX Virtual Firewall VM into an Azure virtual network using the vSRX Virtual Firewall image from Azure Marketplace:

1. Log in to the [Microsoft Azure portal](#) using your Microsoft account user name and password. The Dashboard appears in the Azure portal (see [Figure 112 on page 477](#)). You will see a unified dashboard for all your assets in Azure. Verify that the dashboard includes all subscriptions to which you currently have access, and all resource groups and associated resources.

Figure 112: Microsoft Azure Portal Dashboard

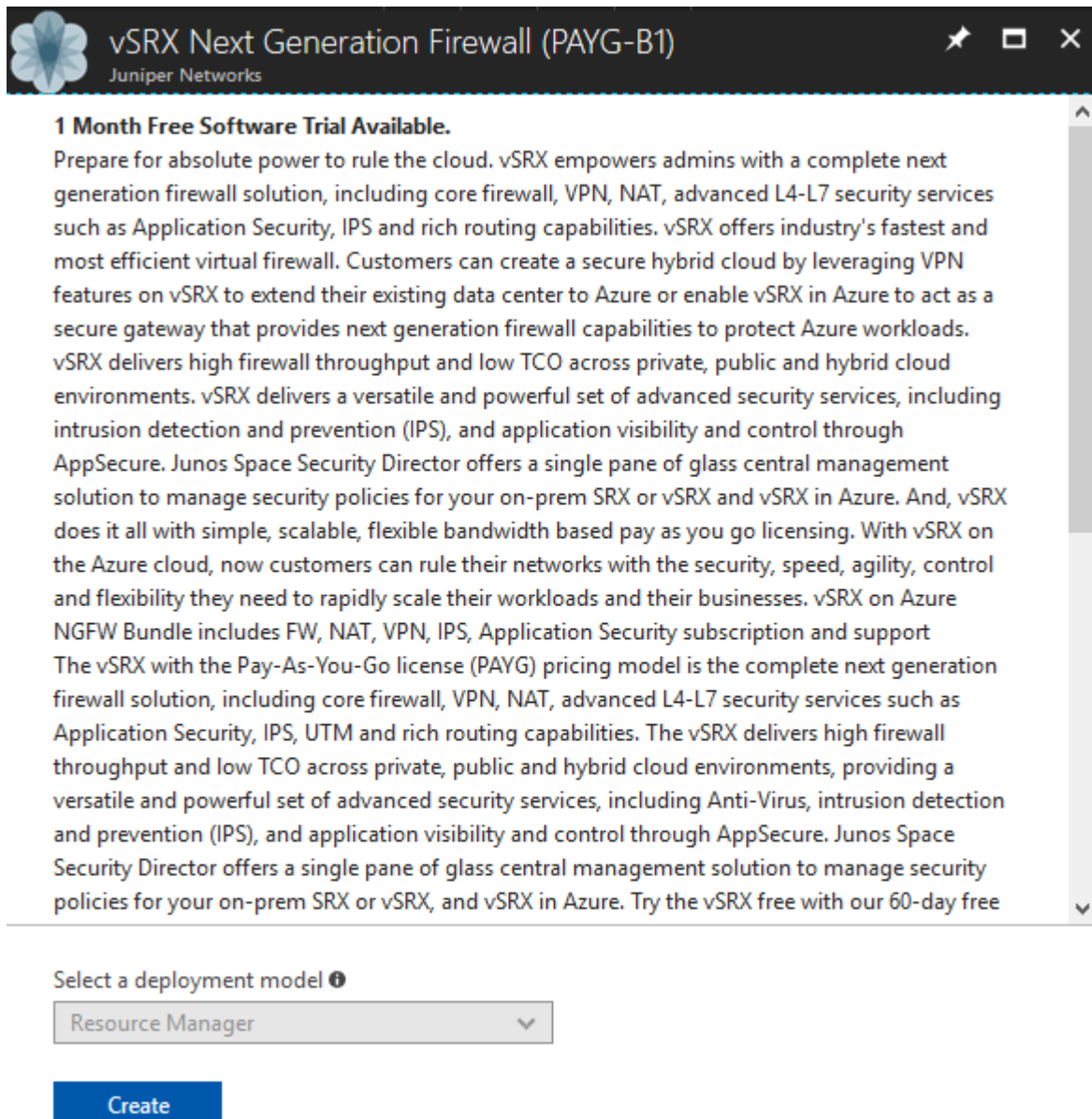


2. Click **Marketplace** from the dashboard to access the Azure Marketplace, and then click **Everything** (or click **New > Everything**). Enter **vsrx** to search for the available Juniper Networks vSRX Virtual Firewall VM images in the Azure Marketplace (see [Figure 113 on page 478](#)). The vSRX Virtual Firewall image is available as a pay-as-you-go (PAYG) or bring-your-own-license (BYOL) service.

**Figure 113: Locating the vSRX Virtual Firewall VM Image in the Azure Marketplace**

3. Select the vSRX Virtual Firewall VM image from the list and then click **Create** to initiate the vSRX Virtual Firewall VM deployment process (see [Figure 114 on page 479](#)).

Figure 114: Initiating vSRX Virtual Firewall VM Deployment



**1 Month Free Software Trial Available.**

Prepare for absolute power to rule the cloud. vSRX empowers admins with a complete next generation firewall solution, including core firewall, VPN, NAT, advanced L4-L7 security services such as Application Security, IPS and rich routing capabilities. vSRX offers industry's fastest and most efficient virtual firewall. Customers can create a secure hybrid cloud by leveraging VPN features on vSRX to extend their existing data center to Azure or enable vSRX in Azure to act as a secure gateway that provides next generation firewall capabilities to protect Azure workloads. vSRX delivers high firewall throughput and low TCO across private, public and hybrid cloud environments. vSRX delivers a versatile and powerful set of advanced security services, including intrusion detection and prevention (IPS), and application visibility and control through AppSecure. Junos Space Security Director offers a single pane of glass central management solution to manage security policies for your on-prem SRX or vSRX and vSRX in Azure. And, vSRX does it all with simple, scalable, flexible bandwidth based pay as you go licensing. With vSRX on the Azure cloud, now customers can rule their networks with the security, speed, agility, control and flexibility they need to rapidly scale their workloads and their businesses. vSRX on Azure NGFW Bundle includes FW, NAT, VPN, IPS, Application Security subscription and support

The vSRX with the Pay-As-You-Go license (PAYG) pricing model is the complete next generation firewall solution, including core firewall, VPN, NAT, advanced L4-L7 security services such as Application Security, IPS, UTM and rich routing capabilities. The vSRX delivers high firewall throughput and low TCO across private, public and hybrid cloud environments, providing a versatile and powerful set of advanced security services, including Anti-Virus, intrusion detection and prevention (IPS), and application visibility and control through AppSecure. Junos Space Security Director offers a single pane of glass central management solution to manage security policies for your on-prem SRX or vSRX, and vSRX in Azure. Try the vSRX free with our 60-day free

Select a deployment model ⓘ

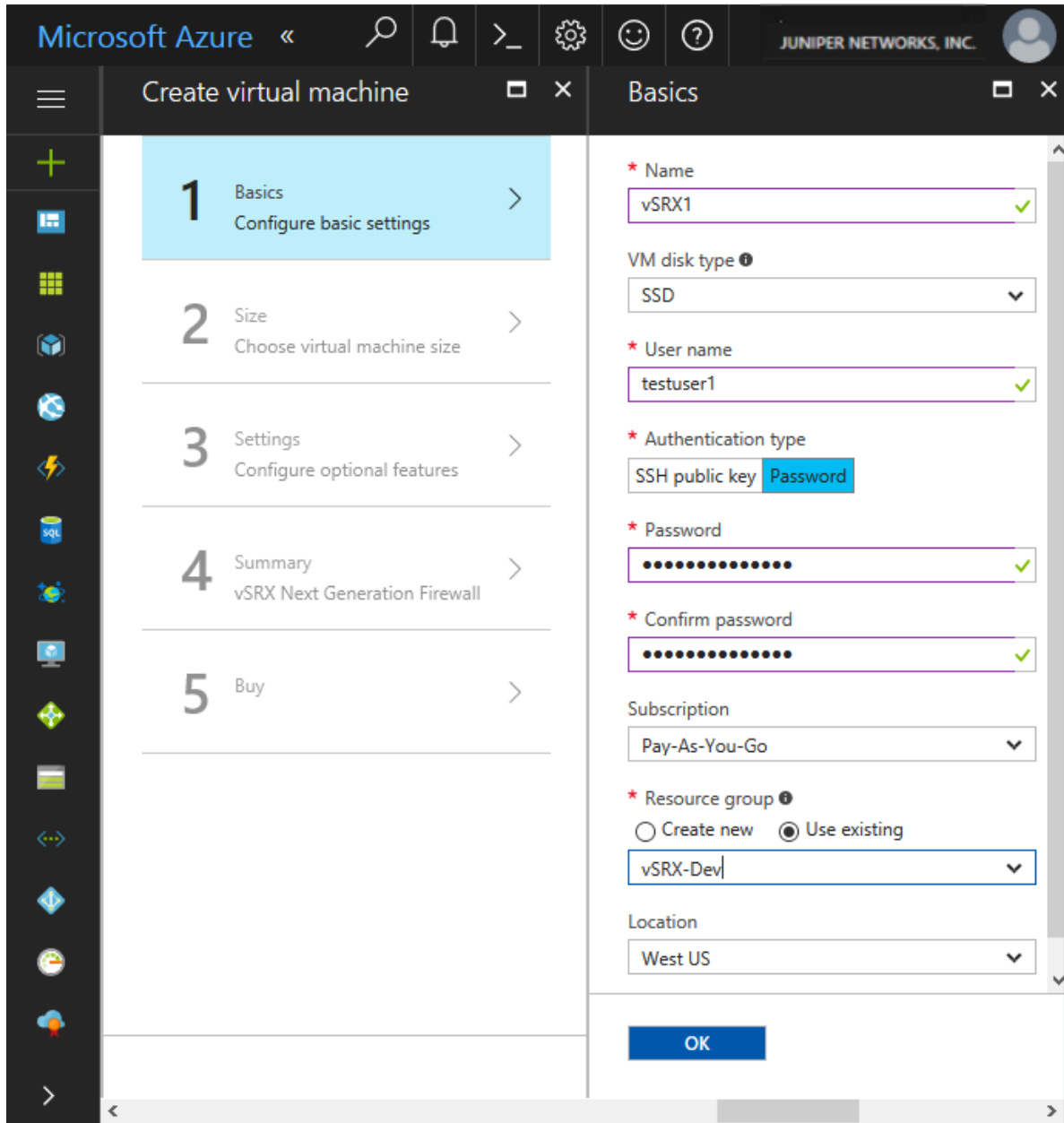
Resource Manager ▼

Create

4. From the Create Virtual Machine blade, **1 Basics**, configure the following parameters (see [Figure 115 on page 480](#)).



Figure 115: Create Virtual Machine - Basics



Parameter	Description
Name	Specify a name for your vSRX Virtual Firewall VM. Your vSRX Virtual Firewall VM name cannot contain non-ASCII or special characters.

(Continued)

Parameter	Description
VM Disk Type	Specify the disk type to use for the vSRX Virtual Firewall VM: <b>SSD</b> or <b>HDD</b> . The default is <b>SSD</b> .
User name	Enter a username to access the vSRX Virtual Firewall VM. The username cannot contain uppercase characters, special characters, or start with a "\$" or "-" character.
Authentication type	Select the required method of authentication to access the vSRX Virtual Firewall VM: <b>Password</b> or <b>SSH public key</b> . Select Password as type of authentication and then enter (and confirm) your password.  <b>NOTE:</b> In Junos OS Release 15.1X49-D91 for vSRX Virtual Firewall, SSH public key is not a supported authentication method. You will need to specify a password to log in to the vSRX Virtual Firewall VM. Starting in Junos OS Release 15.1X49-D110 for vSRX Virtual Firewall, SSH public key is a supported authentication method.
Password	Enter an appropriate root password used to access the vSRX Virtual Firewall VM.
Subscription	Select your Microsoft Azure subscription.
Resource Group	Select an existing resource group or create a new one (see <i>Create a Resource Group</i> ).
Location	Select the Azure geographic region in which you are deploying the vSRX Virtual Firewall VM.

Click **OK**.

- From the Create Virtual Machine blade, **2 Size**, select **DS3\_v2 Standard** as the vSRX Virtual Firewall VM size (see [Figure 116 on page 482](#)). Click **Select**.

DS3\_v2 Standard is used for a vSRX Virtual Firewall VM deployment. See *Requirements for vSRX on Microsoft Azure* for the recommended system requirements for a vSRX Virtual Firewall instance in Microsoft Azure.

Figure 116: Create Virtual Machine - Choose a Size

The screenshot shows the 'Choose a size' page in the Microsoft Azure portal. The navigation pane on the left indicates the following steps:

- 1 Basics (Done)
- 2 Size (Choose virtual machine size) - **Selected**
- 3 Settings (Configure optional features)
- 4 Summary (vSRX Next Generation Firewall)
- 5 Buy

The main content area displays the 'Choose a size' page with the following details:

- Supported disk type: SSD
- Minimum cores: 4
- Minimum memory (GiB): 14
- ★ Recommended | View all

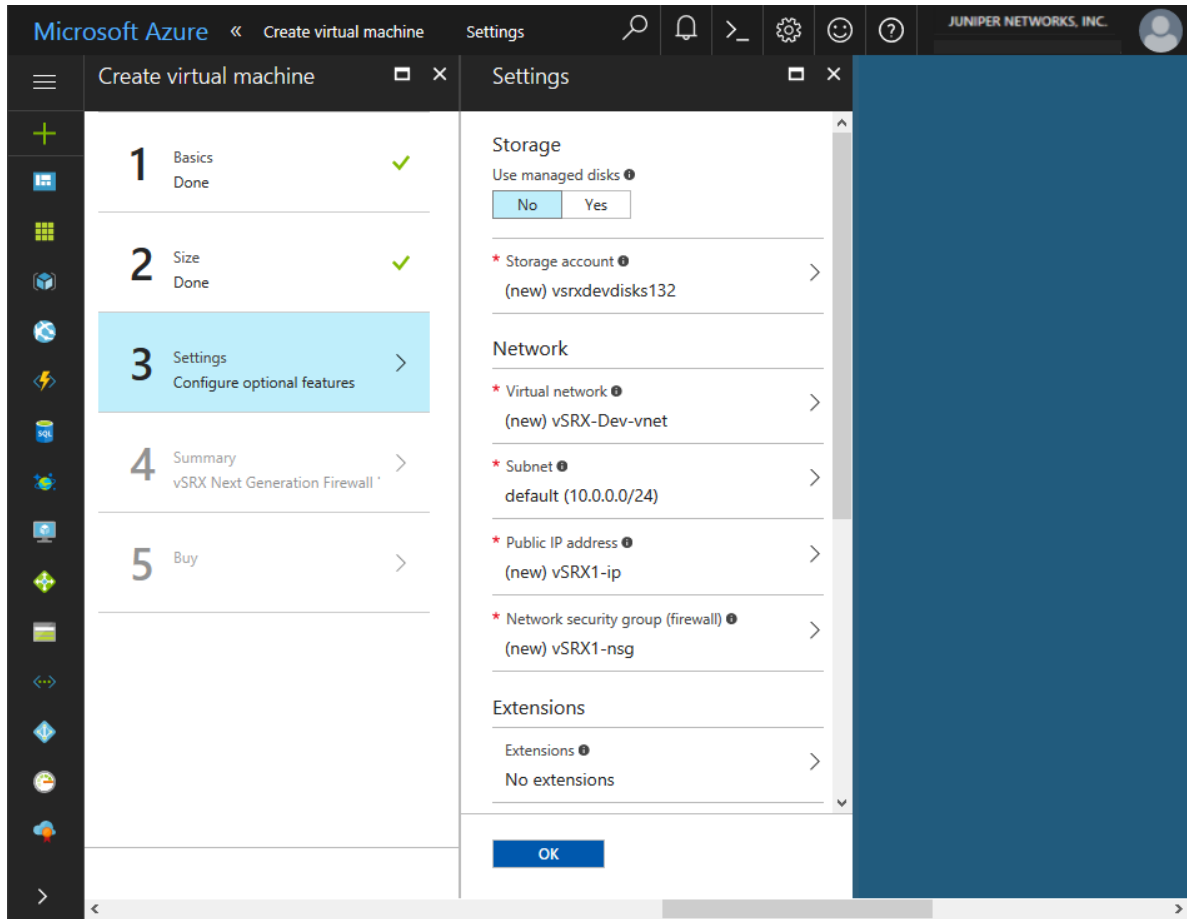
The selected VM size is **DS3\_V2 Standard**, which includes the following specifications:

- 4 Cores
- 14 GB
- 8 Data disks
- 12800 Max IOPS
- 28 GB Local SSD
- Load balancing
- Premium disk support

The estimated price is **207.58 USD/MONTH (ESTIMATED)**. A **Select** button is located at the bottom of the page.

6. From the Create Virtual Machine blade, **3 Settings**, configure the following parameters to define the storage, networking, and monitoring settings for the vSRX Virtual Firewall VM (see [Figure 117 on page 483](#)). Click **OK** when completed.

Figure 117: Create Virtual Machine - Settings



Parameter	Description
Storage	
Used Managed Disks	Specify whether you want Azure to automatically manage the availability of disks to provide data redundancy and fault tolerance without you creating and managing a storage account. Click <b>No</b> .
Storage Account	If you need to change the storage account for the vSRX Virtual Firewall VM, click the right arrow to access the Choose Storage Account blade. Select an existing storage account for the vSRX Virtual Firewall VM, or click <b>Create new (+)</b> to create a new one. See <i>Create a Storage Account</i> for details about creating a new storage account.

*(Continued)*

Parameter	Description
Network	
Virtual Network	<p>If you need to change the virtual network for the vSRX Virtual Firewall VM, click the right arrow to access the Choose Virtual Network blade. Select an existing virtual network for the vSRX Virtual Firewall VM, or click <b>Create new (+)</b> to create a new one. See <i>Create a Virtual Network</i> for details about creating a new virtual network.</p>
Subnet	<p>Enter a subnet, which is a range of IP addresses in your virtual network to isolate VMs. Public subnets have access to the Internet gateway, but private subnets do not.</p> <p>A vSRX Virtual Firewall VM requires two public subnets and one or more private subnets for each individual instance group. The public subnets consist of one for the management interface (fxp0) and another for the two revenue (data) interfaces. The private subnets, connected to other vSRX Virtual Firewall interfaces, ensure that all traffic between applications on the private subnets and the Internet must pass through the vSRX Virtual Firewall instance.</p> <p>To modify the subset for the virtual network, click the right arrow to access the Create Subnet blade.</p> <p>Configure the following parameters:</p> <ul style="list-style-type: none"> <li>• Subnet name—A unique name for the subnet in the Azure virtual network.</li> <li>• Subnet address range—The subnet's address range in CIDR notation. It must be contained by the address space of the virtual network. Subnet address ranges cannot overlap one another. By default, the address range is 10.0.0.0/24.</li> </ul> <p><b>NOTE:</b> The address range of a subnet that is already in use cannot be edited.</p>

*(Continued)*

Parameter	Description
Public IP address	<p>Specify the public IP address that allows communication to the vSRX Virtual Firewall VM from outside the Azure virtual network. To modify the public IP address for the vSRX Virtual Firewall VM, click the right arrow to access the Choose Public IP Address blade. Select a public IP address in your Azure subscription and location, or click <b>Create new (+)</b> to create a new one.</p> <p>Configure the following parameters:</p> <ul style="list-style-type: none"><li>• Name—A unique name for the public IP address.</li><li>• Assignment—There are two methods in which an IP address is allocated to a public IP resource: dynamic or static. By default, public IP addresses are dynamic, where an IP address is not allocated at the time of its creation. Instead, the public IP address is allocated when you start (or create) the resource. The IP address associated to them may change when the vSRX Virtual Firewall VM is deleted.</li></ul> <p>To guarantee that the vSRX Virtual Firewall VM always uses the same public IP address, we recommend you assign a static public IP address.</p>

*(Continued)*

Parameter	Description
Network security group	<p>Specify a network security group, which is a set of firewall rules that control traffic to and from the vSRX Virtual Firewall VM. Each network security group can contain multiple inbound and outbound security rules that enable you to filter traffic by source and destination IP address, port, and protocol. You can apply a network security group to each NIC in the VM.</p> <p>To modify the network security group for the vSRX Virtual Firewall VM to filter traffic, click the right arrow to access the Choose Network Security blade. Select a network security group in your Azure subscription and location, or click <b>Create new (+)</b> to create a new one.</p> <p>Configure the following parameters:</p> <ul style="list-style-type: none"> <li>• Name—A unique name for the network security group.</li> <li>• Inbound rules—You can add one or more inbound security rules to allow or deny traffic to the vSRX Virtual Firewall VM.</li> <li>• Outbound rules—You can add one or more outbound security rules to allow or deny traffic originating from the vSRX Virtual Firewall VM.</li> </ul>
Extensions	
Extensions	No extensions are used for the vSRX Virtual Firewall VM.
High Availability	
Availability Set	<p>Configure two or more VMs in an availability set to provide redundancy to an application.</p> <p><b>NOTE:</b> Availability Set should be set to <b>None</b> for the vSRX Virtual Firewall VM. Availability Set is not used for the vSRX Virtual Firewall VM in Azure because chassis clustering is not supported by the vSRX Virtual Firewall at this time.</p>
Monitoring	

*(Continued)*

Parameter	Description
Boot Diagnostics	Enables or disables the capturing of serial console output and screenshots of the VM running on the host to help diagnose start-up issues. The default is Enabled.
Guest OS Diagnostics	Enables or disables the ability to obtain metrics every minute for the VM. Choices are: <b>Disabled</b> or <b>Enabled</b> . The default is Disabled.
Diagnostics Storage Account	Click the right arrow to view the details of the diagnostics storage account. Automatically fills in with the name of the diagnostics storage account from which you can analyze a set of metrics with your own tools.

7. From the Create Virtual Machine blade, **4 Summary**, review the configuration settings (see [Figure 118 on page 488](#)). If you are satisfied with the configuration settings, click **OK**.



Figure 118: Create Virtual Machine - Summary

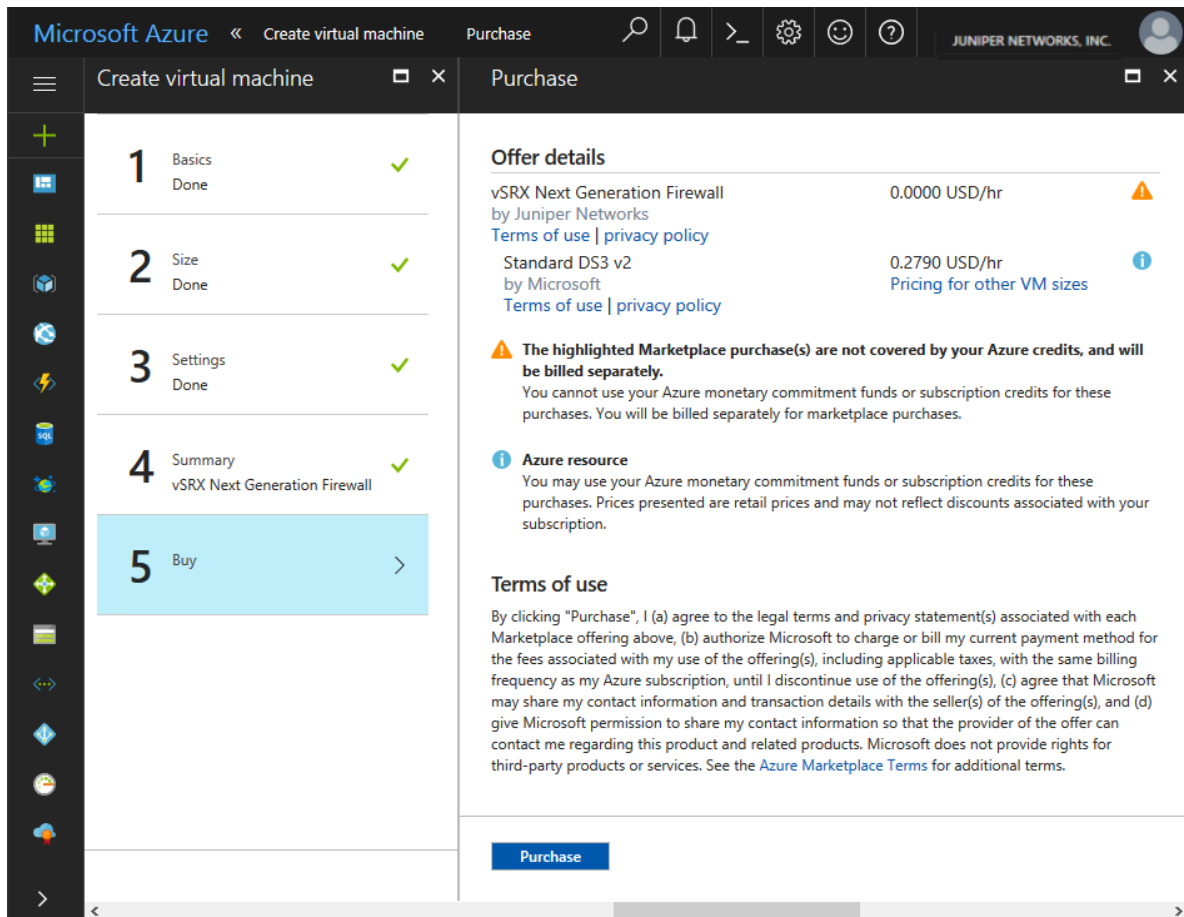
The screenshot displays the 'Create virtual machine' blade in the Microsoft Azure portal, specifically the 'Summary' step. The left-hand navigation pane shows a progress bar with five steps: 1 Basics (Done), 2 Size (Done), 3 Settings (Done), 4 Summary (vSRX Next Generation Firewall), and 5 Buy. The right-hand pane shows a 'Validation passed' message and a list of configuration details for the vSRX1 virtual machine.

Validation passed	
<b>Basics</b>	
Subscription	Pay-As-You-Go
Resource group	vSRX-Dev
Location	West US
<b>Settings</b>	
Computer name	vSRX1
Disk type	SSD
User name	testuser1
Size	Standard DS3 v2
Storage account	(new) vsrxdevdisks132
Managed	No
Virtual network	(new) vSRX-Dev-vnet
Subnet	(new) default (10.0.0.0/24)
Public IP address	(new) vSRX1-ip
Network security group (firewall)	(new) vSRX1-nsg
Availability set	None
Guest OS diagnostics	Disabled
Boot diagnostics	Enabled
Diagnostics storage account	(new) vsrxdevdiag888

At the bottom of the right pane, there are two buttons: 'OK' and 'Download template and parameters'.

8. From the Create Virtual Machine blade, **5 Buy** review the offer details and the terms of use (see [Figure 119 on page 489](#)). If you are satisfied with the offer details and terms of use, click **Purchase**.

Figure 119: Create Virtual Machine - Purchase



You return to the Azure portal dashboard, and the dashboard displays the deployment status of the vSRX Virtual Firewall VM.

## Verify Deployment of vSRX Virtual Firewall to Microsoft Azure

After the vSRX Virtual Firewall VM is created, the Azure portal dashboard lists the new vSRX Virtual Firewall VM under Resource Groups. The corresponding cloud service and storage account also are created and listed. Both the vSRX Virtual Firewall VM and the cloud service are started automatically and their status is listed as *Running*

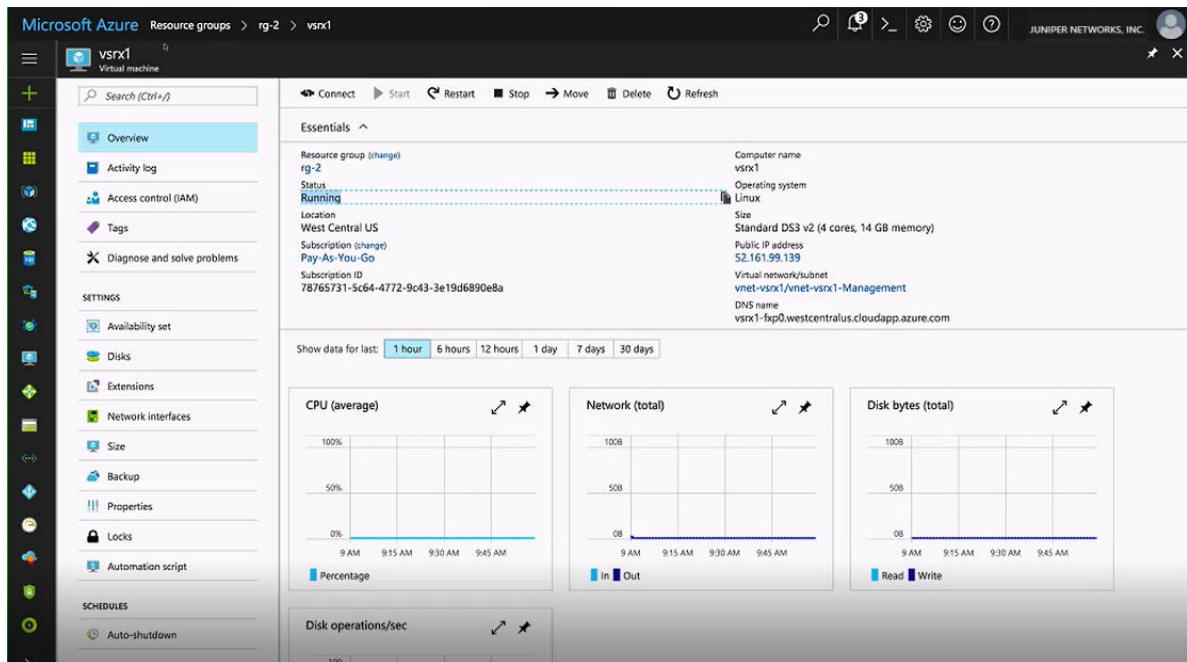
To verify the deployment of the vSRX Virtual Firewall instance to Microsoft Azure:

1. To view the vSRX Virtual Firewall resource group and its resources after deployment is completed, from the right-hand menu, click **Resource groups** to access the Resource Groups page.
2. To view details of the vSRX Virtual Firewall VM associated with the resource group, click the name of the vSRX Virtual Firewall VM. Observe that the status is *Running*.

**NOTE:** You can stop, start, restart, and delete a vSRX Virtual Firewall VM from the Virtual Machine page in the Microsoft Azure portal.

Figure 120 on page 490 shows an example of a Resource groups vSRX Virtual Firewall VM in the Microsoft Azure portal.

Figure 120: Microsoft Azure Resource Groups VM Example



## Log In to a vSRX Virtual Firewall VM

After vSRX Virtual Firewall deployment is completed, the vSRX Virtual Firewall VM is automatically powered on and launched. At this point you can use an SSH client to log in to the vSRX Virtual Firewall VM.

**NOTE:** In Microsoft Azure, individuals and enterprises can host servers and services on the cloud as a pay-as-you-go (PAYG) or bring-your-own-license (BYOL) service. For the vSRX Virtual Firewall on Microsoft Azure deployment, only the BYOL model is supported.

To log in to the vSRX Virtual Firewall VM:

1. From the Azure portal, click **Resource groups** from the menu of services on the dashboard, and then select the vSRX Virtual Firewall VM. Locate the public IP address of the vSRX Virtual Firewall VM from the Settings blade.
2. Use an SSH client to log in to a vSRX Virtual Firewall VM.
3. At the prompt, enter the following login credentials:

**NOTE:** The vSRX Virtual Firewall instance is automatically configured for username and password authentication. To log in, use the login credentials that were defined during the vSRX Virtual Firewall VM configuration (see "[Deploy the vSRX Virtual Firewall Image](#)" on page 476). After initially logging in to the vSRX Virtual Firewall, you can configure SSH public and private key authentication.

```
# ssh <username@vsrx_vm_ipaddress>
```

```
The authenticity of host 'x.x.x.x (x.x.x.x)' ...
ECDSA key fingerprint is SHA256:XXXXXXXXXXXXXXXXXXXXX.
Are you sure you want to continue connecting (yes/no)? yes
Warning: Permanently added 'x.x.x.x' (ECDSA) to the list of known hosts.
Password: xxxxxxxx
username@vsrx_vm_ipaddress>
```

4. Configure the basic settings for the vSRX Virtual Firewall VM (see *Configure vSRX Using the CLI*).

#### Release History Table

Release	Description
15.1X49-D91	Starting in Junos OS Release 15.1X49-D91 for vSRX Virtual Firewall, you can deploy the vSRX Virtual Firewall virtual security appliance in your Azure virtual network by selecting the vSRX Virtual Firewall image from Azure Marketplace and customizing the vSRX Virtual Firewall VM deployment settings and dependencies based on your network requirements in Microsoft Azure Cloud.

#### RELATED DOCUMENTATION

[How to Deploy in Microsoft Azure using Azure Portal and Template](#)

[Microsoft Azure portal overview](#)

[Virtual networks and Windows virtual machines in Azure](#)

[Create, change, or delete network interfaces](#)

---

[Create a VM \(Classic\) with multiple NICs](#)

# Deploy vSRX Virtual Firewall from the Azure CLI

## IN THIS CHAPTER

- Before You Deploy vSRX Virtual Firewall Using the Azure CLI | 493
- Deploy vSRX Virtual Firewall from the Azure CLI | 495

## Before You Deploy vSRX Virtual Firewall Using the Azure CLI

Starting in Junos OS Release 15.1X49-D80 and Junos OS Release 17.3R1, you can deploy the vSRX Virtual Firewall from the Azure CLI and customize the vSRX Virtual Firewall VM deployment settings and dependencies based on your network requirements in Microsoft Azure Cloud.

To help automate and simplify the deployment of the vSRX Virtual Firewall in the Microsoft Azure virtual network, Juniper Networks provides a series of scripts, Azure Resource Manager (ARM) templates and parameter files, and configuration files in the GitHub repository <https://github.com/Juniper/vSRX-Azure>. The ARM template includes resource parameters that enable you to customize your vSRX Virtual Firewall VM deployment, such as login credentials, network interfaces, and storage container name. The template consists of JavaScript Object Notation (JSON) expressions for your vSRX Virtual Firewall deployment.

The vSRX Virtual Firewall deployment files in the GitHub repository include:

- The **deploy-azure-vsrx.sh** shell script to automate the deployment and configuration of the vSRX Virtual Firewall virtual machine (VM).
- The **vsrx.json** template file to define the components of the Azure resource group and virtual hardware settings (VM size, interface number and network) of the vSRX Virtual Firewall VM.
- The **vsrx.parameters.json** parameter file to identify the network interface parameters used to deploy the vSRX Virtual Firewall VM in Azure.

Before you deploy the vSRX Virtual Firewall virtual security appliance from the Azure CLI:

- Review the requirements for deploying a vSRX Virtual Firewall VM in Microsoft Azure Cloud in *Requirements for vSRX on Microsoft Azure*.

- Obtain an account for and a subscription to Microsoft Azure (see [Microsoft Azure](#)).
- From the Azure portal, you must first manually deploy the vSRX Virtual Firewall image (only once) by using either the **vSRX Next Generation Firewall (BYOL)** or the **vSRX Next Generation Firewall (PAYG)** SKU to accept the EULA terms. This is a requirement before you can deploy the vSRX Virtual Firewall image from the Azure CLI. By default, the Azure portal deployment tool uses **vSRX Next Generation Firewall (BYOL)** SKU as the source image. Use your Microsoft account username and password to log into the [Microsoft Azure portal](#).

**NOTE:** You will encounter a **MarketplacePurchaseEligibilityFailed** error if do not first accept the EULA terms for the vSRX Virtual Firewall image in the Azure portal before attempting to deploy the vSRX Virtual Firewall image from the Azure CLI.

- Install Azure command line interface (Azure CLI) 1.0 and enable Azure Resource Management (ARM) mode (see [Install the Azure CLI](#)).

**NOTE:** The vSRX Virtual Firewall for Azure deployment shell script **deploy-azure-vsrx.sh** is written in shell and Azure CLI version 1.0 commands and does not support Azure CLI version 2.0.

- Purchase a vSRX Virtual Firewall license or request an evaluation license. Licenses can be procured from the [Juniper Networks License Management System \(LMS\)](#).

**NOTE:** Deployment of vSRX Virtual Firewall to Microsoft Azure does not support the use of the Azure CLI from Microsoft Windows. This is because the `deploy-azure-vsrx.sh` shell script that is used as part of the deployment procedure can be run only from the Linux or Mac OS CLI.

When you deploy a vSRX Virtual Firewall VM in an Azure virtual network, note the following specifics of the deployment configuration:

- Use your Microsoft account username and password to log into the [Microsoft Azure portal](#).
- Ensure that your Azure subscription includes the following for your vSRX Virtual Firewall VM:
  - Resource group, as described in *Create a Resource Group*.
  - Storage account, as described in *Create a Storage Account*.
  - Virtual network, as described in *Create a Virtual Network*.

vSRX Virtual Firewall deployment from the Azure CLI is described in detail in *Deploy vSRX from the Azure CLI*.

#### Release History Table

Release	Description
15.1X49-D80	Starting in Junos OS Release 15.1X49-D80 and Junos OS Release 17.3R1, you can deploy the vSRX Virtual Firewall from the Azure CLI and customize the vSRX Virtual Firewall VM deployment settings and dependencies based on your network requirements in Microsoft Azure Cloud.

#### RELATED DOCUMENTATION

[Azure Resource Manager overview](#)

[Deploy resources with Resource Manager templates and Azure CLI](#)

## Deploy vSRX Virtual Firewall from the Azure CLI

#### IN THIS SECTION

- [Install the Microsoft Azure CLI | 496](#)
- [Download the vSRX Virtual Firewall Deployment Tools | 497](#)
- [Change Parameter Values in the vSRX Virtual Firewall.parameter.json File | 498](#)
- [Deploy the vSRX Virtual Firewall Using the Shell Script | 502](#)
- [Verify Deployment of vSRX Virtual Firewall to Microsoft Azure | 504](#)
- [Log In to a vSRX Virtual Firewall Instance | 507](#)

Starting in Junos OS Release 15.1X49-D80 and Junos OS Release 17.3R1, you can deploy the vSRX Virtual Firewall from the Azure CLI and customize the vSRX Virtual Firewall VM deployment settings and dependencies based on your network requirements in Microsoft Azure Cloud.

Use the following procedure to deploy and configure vSRX Virtual Firewall as a virtual security appliance in a Microsoft Azure virtual network from the Azure CLI. In this procedure, you use the Azure CLI running in Azure Resource Manager (ARM) mode.



**NOTE:** Be sure you have an account for and a subscription to Microsoft Azure before deploying the vSRX Virtual Firewall to Azure (see [Microsoft Azure](#)).

If you do not have an Azure subscription, then you can create a free account before you begin. See the [Microsoft Azure website](#) for more details.

**NOTE:** From the Azure portal, you must first manually deploy the vSRX Virtual Firewall image (only once) by using either the **vSRX Next Generation Firewall (BYOL)** or the **vSRX Next Generation Firewall (PAYG)** SKU to accept the EULA terms. This is a requirement before you can deploy the vSRX Virtual Firewall image from the Azure CLI. By default, the Azure portal deployment tool uses **vSRX Next Generation Firewall (BYOL)** SKU as the source image. Use your Microsoft account username and password to log into the [Microsoft Azure portal](#).

You will encounter a **MarketplacePurchaseEligibilityFailed** error if do not first accept the EULA terms for the vSRX Virtual Firewall image in the Azure portal before attempting to deploy the vSRX Virtual Firewall image from the Azure CLI.

## Install the Microsoft Azure CLI

To install and log in to the Microsoft Azure CLI:

1. Install the Microsoft Azure CLI 1.0 as outlined in [Install the Azure CLI](#). You have several options to install the Azure CLI package for either the Linux or Mac OS; be sure to select the correct installation package.

**NOTE:** The vSRX Virtual Firewall for Azure deployment shell script **deploy-azure-vsrx.sh** is written in shell and Azure CLI version 1.0 commands and does not support Azure CLI version 2.0.

**NOTE:** Deployment of vSRX Virtual Firewall to Microsoft Azure does not support the use of the Azure CLI from Microsoft Windows. This is because the **deploy-azure-vsrx.sh** shell script that is used as part of the deployment procedure can be run only from the Linux or Mac OS CLI.

2. Log into the Azure CLI.

```
> azure login
```

3. At the prompt, copy the code that appears in the command output.

```
Executing command login
To sign in, use a web browser to open the page http://aka.ms/devicelogin. Enter the
codeXXXXXXXXX to authenticate
```

4. Open a Web browser to <http://aka.ms/devicelogin>, enter the code, and then click **Continue**. Enter your Microsoft Azure username and password credentials. When the process completes, the command shell completes the login process.

```
Added subscription Microsoft Azure Enterprise
To sign in, use a web browser to open the page http://aka.ms/deviceloginlogin command OK
```

**NOTE:** If you have multiple Azure subscriptions, connecting to Azure grants access to all subscriptions associated with your credentials. One subscription is selected as the default, and used by the Azure CLI when performing operations. You can view the subscriptions, including the current default subscription, using the `azure account list` command.

5. Ensure that the Azure CLI is in Azure Resource Manager (ARM) mode.

```
> azure config mode arm
```

**NOTE:** When the Azure CLI is initially installed, the CLI is in ARM mode.

## Download the vSRX Virtual Firewall Deployment Tools

Juniper Networks provides a set of scripts, templates, parameter files, and configuration files in Juniper's GitHub repository. These tools are intended to help simplify the deployment of the vSRX Virtual Firewall to Azure when using the Azure CLI.

**NOTE:** For background information on the scripts, templates, parameter files, and configuration files, see *Before You Deploy vSRX Using the Azure CLI*.

To download the vSRX Virtual Firewall deployment tools:

1. Access GitHub by using the following link: <https://github.com/Juniper/vSRX-Azure>.

2. Click **Clone or download** to download to your computer the `vSRX-Azure-master.zip` file from Github containing all files and directories from `vSRX-Azure`. The `vSRX-Azure-master` directory includes the following directories and files:



3. Extract the compressed `vSRX-Azure-master.zip` file to a location on your computer.

### Change Parameter Values in the `vSRX Virtual Firewall.parameter.json` File

In the `vsrx.parameters.json` file, you need to modify parameter values specific to your `vSRX Virtual Firewall` deployment in Microsoft Azure. These parameters are used as part of the automatic deployment performed by the `deploy-azure-vsrx.sh` script.

Keep in mind that by default vSRX Virtual Firewall uses fxp0 as the egress interface to the Internet. For features requiring Internet connections that use a revenue port (such as VPN, Content Security, and so on), routing instances are required to isolate the traffic between the management network and the revenue network.

To change parameter values in the **vsrx.parameters.json** file:

1. Open the **vsrx.parameters.json** file with a text editor.
2. Modify the values in the **vsrx.parameters.json** file based on the specifics of your vSRX Virtual Firewall deployment. As an example, the following table outlines the parameters in the **vsrx.parameters.json** file found in `sample-templates\arm-templates-tool\templates\vsrx-gateway` that might require modification.



**CAUTION:** It is critical that you change the vSRX Virtual Firewall-username and vSRX Virtual Firewall-password login credentials listed in the **vsrx.parameters.json** file before you launch the vSRX Virtual Firewall instance and login for the first time. Note that you cannot reset login credentials for the vSRX Virtual Firewall using the Microsoft Azure portal or the Azure CLI.

Parameter	Default Value	Comment
<i>storageAccountName</i>	juniperstore01	Must be unique for each deployment.
<i>storageContainerName</i>	vhds	Name of the Microsoft Azure storage container (VHDs).
<i>vSRX Virtual Firewall-name</i>	vSRX Virtual Firewall-gw	Specifies the vSRX Virtual Firewall hostname.
<i>vSRX Virtual Firewall-addr-ge-0-0-0</i>	192.168.10.20	IP address of vSRX Virtual Firewall interface ge-0/0/0.0.
<i>vSRX Virtual Firewall-addr-ge-0-0-1</i>	192.168.20.20	IP address of vSRX Virtual Firewall interface ge-0/0/1.0.

*(Continued)*

Parameter	Default Value	Comment
<i>vSRX Virtual Firewall-username</i>	demo	Change to an appropriate username for the login credentials used to access the vSRX Virtual Firewall.
<i>vSRX Virtual Firewall-password</i>	Demo123456	Change to an appropriate password for the login credentials used to access the vSRX Virtual Firewall.
<i>vSRX Virtual Firewall-sshkey</i>	ssh-rsa placeholder	<p>Specifies the root authentication password for the vSRX Virtual Firewall VM by entering an SSH public key string ( RSA or DSA). By default, the <b>deploy-azure-vsrx.sh</b> deployment script selects the password authentication method, unless -p, followed by the SSH RSA public key file (id_rsa.pub by default), is specified.</p> <p><b>NOTE:</b> Starting in Junos OS Release 15.1X49-D100 for vSRX Virtual Firewall, both password and SSH public key authentication are supported, and password authentication is chosen by default.</p>

*(Continued)*

Parameter	Default Value	Comment
<i>vSRX Virtual Firewall-disk</i>	placeholder	The source image to create the vSRX Virtual Firewall instance. By default, the <b>deploy-azure-vsrx.sh</b> script uses the <b>vSRX Next Generation Firewall (BYOL)</b> SKU in the Azure Marketplace as the source image to deploy vSRX Virtual Firewall instance, unless <b>-i</b> is used to explicitly specify the vSRX Virtual Firewall instance image location.
<i>vnet-prefix</i>	192.168.0.0/16	IP address prefix of the virtual network.
<i>vnet-mgt-subnet-basename</i>	mgt-subnet	Name of management network connected to fxp0.
<i>vnet-mgt-subnet-prefix</i>	192.168.0.0/24	IP address prefix of management network connected to fxp0.
<i>vnet-trust-subnet-basename</i>	trust-subnet	Name of network connected to trust security zone: ge-0/0/1.0 on the vSRX Virtual Firewall.
<i>vnet-trust-subnet-prefix</i>	192.168.20.0/24	IP address prefix of network connected to trust security zone: ge-0/0/1.0 on the vSRX Virtual Firewall.
<i>vnet-untrust-subnet-basename</i>	untrust-subnet	Name of network connected to untrust security zone: ge-0/0/0.0 on the vSRX Virtual Firewall.

*(Continued)*

Parameter	Default Value	Comment
<i>vnet-untrust-subnet-prefix</i>	192.168.10.0/24	IP address prefix of network connected to untrust security zone: ge-0/0/0.0 on the vSRX Virtual Firewall.

3. Save your changes to the **vsrx.parameters.json** file.

## Deploy the vSRX Virtual Firewall Using the Shell Script

The **deploy-azure-vsrx.sh** shell script deploys the vSRX Virtual Firewall virtual machine in a resource group that is based on your Azure Cloud geographic location. The script uses the storage account and network values defined in the **vsrx.parameters.json** file.

To deploy vSRX Virtual Firewall to the Azure virtual network:

1. At the bash prompt in the Azure CLI, run the **deploy-azure-vsrx.sh** script. By default, the script deploys the vSRX Virtual Firewall VM using the **vSRX Next Generation Firewall (BYOL)** SKU as the source image from the Azure Marketplace. The following information is read from the vSRX Virtual Firewall.json file as part of the deployment:

- VM Size: Standard\_D3\_v2
- Publisher: Juniper Networks
- SKU: vSRX Virtual Firewall-byol-azure-image
- Offering: vSRX Virtual Firewall-next-generation-firewall

The following is an example of the command syntax. In this example, the script uses the vSRX Virtual Firewall image to deploy the vSRX Virtual Firewall VM in resource group “example\_rg” at the Azure location “westus.” The storage account and network values are defined in the **vsrx.parameters.json** file.

```
> ./deploy-azure-vsrx.sh -g example_rg -l westus -f vSRX-Azure/sample-templates/arm-templates-tool/templates/vsrx-gateway/vsrx.json -e vSRX-Azure/sample-templates/arm-templates-tool/templates/vsrx-gateway/vsrx.parameters.json
```

**NOTE:** When you specify the vSRX Virtual Firewall source image URL with the option `-i`, the script copies the vSRX Virtual Firewall source image to create the virtual hardware disk file and to set the `vsrx-disk` parameter in **`vsrx.parameters.json`** to this value.

The default parameter values in the command syntax include:

- `example_rg` is the resource group name (`-g`).
  - `westus` is the Azure location (`-l`).
  - `vSRX Virtual Firewall.json` in the folder **`vSRX-Azure/sample-templates/arm-templates-tool/templates/vsrx-gateway`** is the default Azure template file (`-f`).
  - `vSRX Virtual Firewall.parameters.json` in the folder **`vSRX-Azure/sample-templates/arm-templates-tool/templates/vsrx-gateway`** is the default parameter file (`-e`).
2. Monitor the stages of deployment of vSRX Virtual Firewall to Microsoft Azure as they occur on screen. Deployment encompasses operations such as creating a resource group, storage account, template group (including configuration parameters).

**NOTE:** Creation of the storage account can take approximately 3 to 5 minutes on average. However, in some cases, it might take as long as 15 to 20 minutes.

```

➔ arm-templates-tool ./deploy-azure-vsrx.sh
Use default resource group name 'vsrx'
info:   Executing command config mode
info:   New mode is arm
info:   config mode command OK
info:   Executing command group create
+ Getting resource group vsrx
+ Creating resource group vsrx
info:   Created resource group vsrx
data:   Id:                               /subscriptions/1c3367ba-71fc-48df-898a-d9eab4f1d673/
resourceGroups/vsrx
data:   Name:                               vsrx
data:   Location:                            westus
data:   Provisioning State: Succeeded
data:   Tags: null
data:
info:   group create command OK

```



```

info: Executing command storage account create
...
data: DeploymentName      : deployvsrx
data: ResourceGroupName    : vsrx
data: ProvisioningState    : Succeeded
data: Timestamp            : Thu Jul 20 2017 12:31:45 GMT+0800 (CST)
data: Mode                  : Incremental
data: CorrelationId       : a99b89f8-5919-4dbc-b8a5-6d76b30fcb67
data: DeploymentParameters :
data: Name                  Type                Value
data: -----
data: storageAccountName     String             jnprsa01
data: storageContainerName   String             vhds
data: vsrx-name               String             vsrx-test01
data: vsrx-addr-ge-0-0-0     String             192.168.10.20
data: vsrx-addr-ge-0-0-1     String             192.168.20.20
data: vsrx-username           String             demo
data: vsrx-password          SecureString       undefined
data: vsrx-sshkey             String             ssh-rsa placeholder
data: vsrx-disk               String             placeholder
data: vnet-prefix             String             192.168.0.0/16
data: vnet-mgt-subnet-basename String             mgt-subnet
data: vnet-mgt-subnet-prefix  String             192.168.0.0/24
data: vnet-trust-subnet-basename String            trust-subnet
data: vnet-trust-subnet-prefix String            192.168.20.0/24
data: vnet-untrust-subnet-basename String            untrust-subnet
data: vnet-untrust-subnet-prefix String            192.168.10.0/24
info: group deployment create command OK

```

When the deployment process completes, you will see the message “info: group deployment create command Ok.

## Verify Deployment of vSRX Virtual Firewall to Microsoft Azure

To verify the deployment of the vSRX Virtual Firewall instance to Microsoft Azure:

1. Open a Web browser to <https://portal.azure.com/> and login to the Microsoft Azure portal using your login credentials. The Dashboard view appears in the Azure portal . You will see a unified dashboard for all your assets in Azure. Verify that the Dashboard includes all subscriptions to which you currently have access, and all resource groups and associated resources.
2. To view the vSRX Virtual Firewall resource group and its resources after deployment is completed, from the right- hand menu, click **Resource groups** to access the Resource Groups page.

Figure 121 on page 505 shows an example of the Resources group page in the Microsoft Azure portal.

Figure 121: Microsoft Azure Resource Groups Page Example

The screenshot displays the Microsoft Azure portal interface for a resource group named 'vSRX'. The page is divided into several sections:

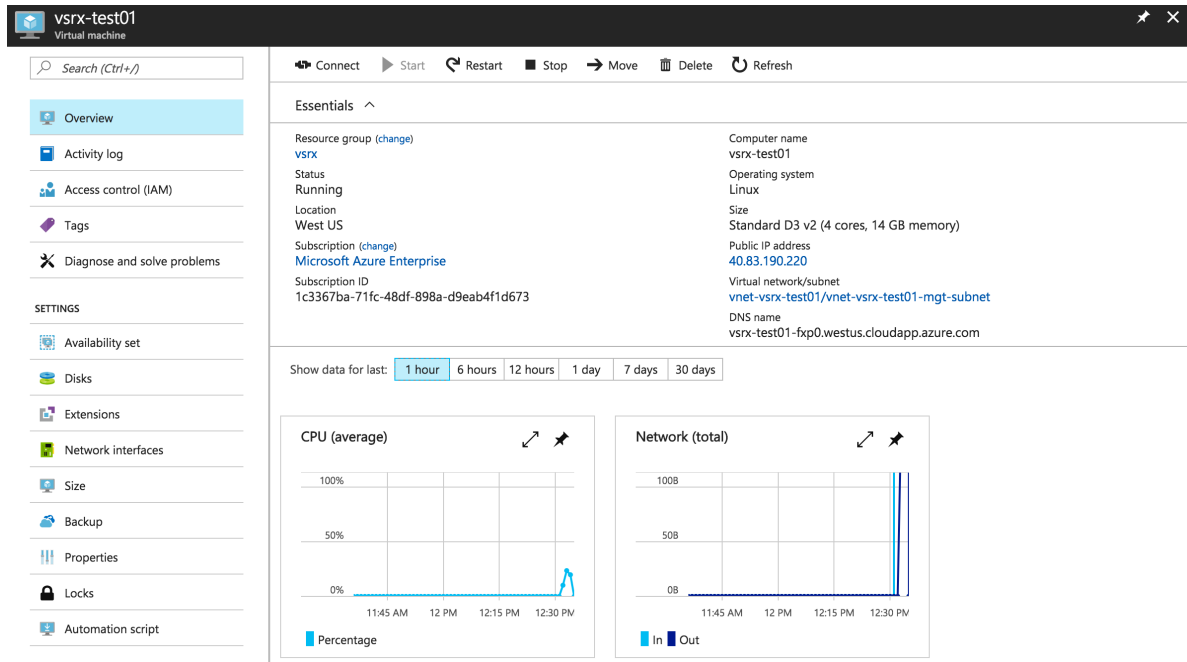
- Subscriptions:** Shows 'Microsoft Azure Enterprise' with a subscription ID of '1c3367ba-71fc-48df-898a-d9eab4f1d673'. It indicates '1 Succeeded' deployment.
- Essentials:** Includes filters for 'Filter by name...', 'All types', 'All locations', and 'No grouping'.
- 10 items:** A table listing resources within the group:
 

NAME	TYPE	LOCATION
if-vsrx-test01-fxp0	Network interface	West US
if-vsrx-test01-ge-0-0-0	Network interface	West US
if-vsrx-test01-ge-0-0-1	Network interface	West US
jnprsa01	Storage account	West US
rtt-trust-subnet-vnet-vsrx-test01	Route table	West US
rtt-untrust-subnet-vnet-vsrx-test01	Route table	West US
vnet-vsrx-test01	Virtual network	West US
vsrx-test01	Virtual machine	West US
vsrx-test01-fxp0	Public IP address	West US
vsrx-test01-ge-0-0-0	Public IP address	West US
- Navigation and Settings:** Includes sections for 'Overview', 'Activity log', 'Access control (IAM)', 'Tags', 'SETTINGS' (Quickstart, Resource costs, Deployments, Policies, Properties, Locks, Automation script), and 'MONITORING' (Metrics, Alert rules, Diagnostics logs, Annihilation insights).

- To view details of the vSRX Virtual Firewall VM associated with the resource group, click the name of the vSRX Virtual Firewall.

Figure 122 on page 506 shows an example of the Resource groups VM in the Microsoft Azure portal.

Figure 122: Microsoft Azure Resource Groups VM Example

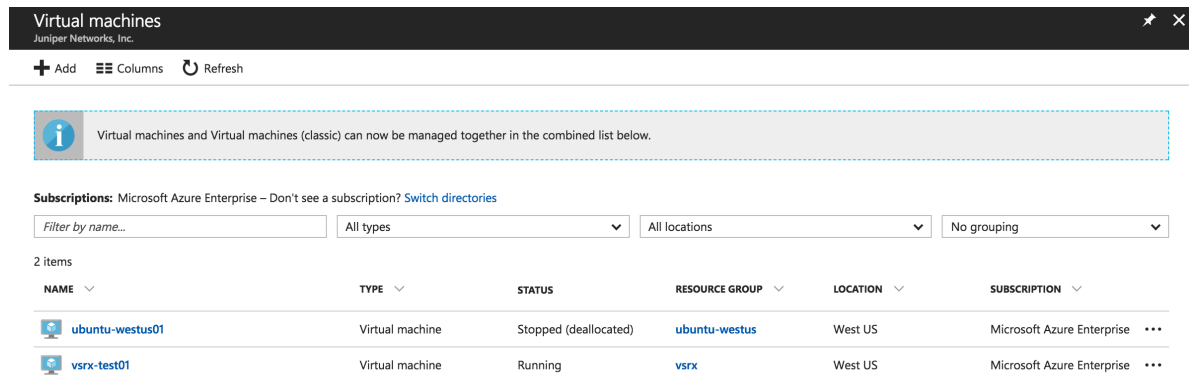


- To see a summary view of the VMs in your subscription, including the newly deployed vSRX Virtual Firewall, click the Virtual Machines icon in the left pane. On the Virtual machines page, check the vSRX Virtual Firewall VM status after deployment is completed. Observe that the status is Running.

**NOTE:** You can stop, start, restart, and delete a VM from the Virtual machines page in the Microsoft Azure portal.

Figure 123 on page 507 shows an example of the Microsoft Azure Virtual machines page.

Figure 123: Microsoft Azure Virtual Machines Page Example



Virtual machines and Virtual machines (classic) can now be managed together in the combined list below.

Subscriptions: Microsoft Azure Enterprise – Don't see a subscription? [Switch directories](#)

Filter by name... All types All locations No grouping

2 items

NAME	TYPE	STATUS	RESOURCE GROUP	LOCATION	SUBSCRIPTION
ubuntu-westus01	Virtual machine	Stopped (deallocated)	ubuntu-westus	West US	Microsoft Azure Enterprise
vsrx-test01	Virtual machine	Running	vsrx	West US	Microsoft Azure Enterprise

## Log In to a vSRX Virtual Firewall Instance

After vSRX Virtual Firewall deployment is completed, the vSRX Virtual Firewall instance is automatically powered on and launched. At this point you can use an SSH client to log in to the vSRX Virtual Firewall instance.

**NOTE:** In Microsoft Azure, individuals and enterprises can host servers and services on the cloud as a pay-as-you-go (PAYG) or bring-your-own-license (BYOL) service. For the vSRX Virtual Firewall on Microsoft Azure deployment, only the BYOL model is supported.

To log in to the vSRX Virtual Firewall VM:

1. From the Azure portal, click **Resource groups** from the menu of services on the dashboard, and then select the vSRX Virtual Firewall VM. Locate the public IP address of the vSRX Virtual Firewall VM from the Settings blade.
2. Use an SSH client to log in to a vSRX Virtual Firewall instance.
3. At the prompt, enter the following login credentials:

**NOTE:** Starting in Junos OS Release 15.1X49-D80 and Junos OS Release 17.3R1, only password authentication is supported. Starting in Junos OS Release 15.1X49-D100 for vSRX Virtual Firewall, both password and SSH public key authentication are supported, and password authentication is chosen by default.

The vSRX Virtual Firewall instance is automatically configured for username and password authentication. To log in, use the login credentials that were defined in the `vsrx.parameters.json` file (see ["Change Parameter Values in the vSRX Virtual](#)

[Firewall.parameter.json File" on page 498](#)). After initially logging to the vSRX Virtual Firewall, you can configure SSH public and private key authentication.

```
# ssh <username@vsrx_vm_ipaddress>
```

```
The authenticity of host 'x.x.x.x (x.x.x.x)' ...
ECDSA key fingerprint is SHA256:XXXXXXXXXXXXXXXXXXXXX.
Are you sure you want to continue connecting (yes/no)? yes
Warning: Permanently added 'x.x.x.x' (ECDSA) to the list of known hosts.
Password: xxxxxxxx
username@vsrx_vm_ipaddress>
```

4. Configure the basic settings for the vSRX Virtual Firewall VM (see *Configure vSRX Using the CLI*).

#### Release History Table

Release	Description
15.1X49-D80	Starting in Junos OS Release 15.1X49-D80 and Junos OS Release 17.3R1, you can deploy the vSRX Virtual Firewall from the Azure CLI and customize the vSRX Virtual Firewall VM deployment settings and dependencies based on your network requirements in Microsoft Azure Cloud.
15.1X49-D80	Starting in Junos OS Release 15.1X49-D80 and Junos OS Release 17.3R1, only password authentication is supported.
15.1X49-D100	Starting in Junos OS Release 15.1X49-D100 for vSRX Virtual Firewall, both password and SSH public key authentication are supported, and password authentication is chosen by default.
15.1X49-D100	Starting in Junos OS Release 15.1X49-D100 for vSRX Virtual Firewall, both password and SSH public key authentication are supported, and password authentication is chosen by default.

#### RELATED DOCUMENTATION

| [Connect from Microsoft Azure CLI](#)

# Configure and Manage vSRX Virtual Firewall for Microsoft Azure

## IN THIS CHAPTER

- [Configure vSRX Virtual Firewall Using the CLI | 509](#)
- [Configure vSRX Virtual Firewall Using the J-Web Interface | 511](#)
- [Remove a vSRX Virtual Firewall Instance from Microsoft Azure | 515](#)
- [Upgrade Junos OS Software on a vSRX Virtual Firewall Instance | 515](#)

## Configure vSRX Virtual Firewall Using the CLI

To configure the vSRX Virtual Firewall instance using the CLI:

1. Verify that the instance is powered on.
2. Log in using the username and password credentials for your vSRX Virtual Firewall VM deployment.
3. Start the CLI.

```
root#cli
root@>
```

4. Enter configuration mode.

```
configure
[edit]
root@#
```

- Set the root authentication password by entering a *cleartext* password, an encrypted password, or an SSH public key string (*DSA* or *RSA*).

```
[edit]
root@# set system root-authentication plain-text-password
New password: password
Retype new password: password
```

- Configure the traffic interfaces.

```
[edit]
root@# set interfaces ge-0/0/0 unit 0 family inet address assigned_ip/netmask
root@# set interfaces ge-0/0/1 unit 0 family inet address assigned_ip/netmask
```

**NOTE:** Configuration of the management interface fxp0 for the vSRX Virtual Firewall is not necessary, because it is configured during vSRX Virtual Firewall VM deployment. Do not change the configuration for interface fxp0 and the default routing table or you will lose connectivity.

- Configure routing interfaces to isolate management network and traffic network.

```
[edit]
root@# set routing-instances vsrx-vr1 instance-type virtual-router
root@# set routing-instances vsrx-vr1 interface ge-0/0/0.0
root@# set routing-instances vsrx-vr1 interface ge-0/0/1.0
```

- Verify the configuration changes.

```
[edit]
root@# commit check
configuration check succeeds
```

- Commit the current configuration to make it permanent and to avoid the possibility of losing connectivity to the vSRX Virtual Firewall instance.

```
[edit]
root@# commit confirmed
commit confirmed will be automatically rolled back in 10 minutes unless confirmed
```

```
commit complete
# commit confirmed will be rolled back in 10 minutes
```

10. Commit the configuration to activate it on the instance.

```
[edit]
root@# commit
commit complete
```

11. Optionally, use the `show` command to display the configuration to verify that it is correct.

**NOTE:** Certain Junos OS software features require a license to activate the feature. To enable a licensed feature, you need to purchase, install, manage, and verify a license key that corresponds to each licensed feature. To conform to software feature licensing requirements, you must purchase one license per feature per instance. The presence of the appropriate software unlocking key on your virtual instance allows you to configure and use the licensed feature. See [Managing Licenses for vSRX](#) for details.

## RELATED DOCUMENTATION

[Junos OS for SRX Series](#)

[CLI User Guide](#)

## Configure vSRX Virtual Firewall Using the J-Web Interface

### IN THIS SECTION

- [Access the J-Web Interface and Configuring vSRX Virtual Firewall | 512](#)
- [Apply the Configuration | 514](#)
- [Add vSRX Virtual Firewall Feature Licenses | 515](#)



## Access the J-Web Interface and Configuring vSRX Virtual Firewall

Use the Junos OS CLI to configure, at a minimum, the following parameters before you can access a vSRX Virtual Firewall VM using J-Web:



**CAUTION:** Do not change the configuration for interface fxp0 and default routing table or you will lose connectivity to the vSRX Virtual Firewall instance.

To configure vSRX Virtual Firewall using the *J-Web* Interface:

1. Launch a Web browser from the management instance.
2. Enter the vSRX Virtual Firewall fxp0 interface IP address in the Address box.
3. Specify the username and password.
4. Click **Log In**, and select the **Configuration Wizards** tab from the left navigation panel. The J-Web Setup wizard page opens.
5. Click **Setup**.

You can use the Setup wizard to configure the vSRX Virtual Firewall VM or edit an existing configuration.

- Select **Edit Existing Configuration** if you have already configured the wizard using the factory mode.
- Select **Create New Configuration** to configure the vSRX Virtual Firewall VM using the wizard.

The following configuration options are available in the guided setup:

- Basic

Select **basic** to configure the vSRX Virtual Firewall VM name and user account information as shown in [Table 85 on page 512](#).

- Instance name and user account options

**Table 85: Instance Name and User Account Information**

Field	Description
Instance name	Type the name of the instance. For example: <b>vSRX</b> .
Root password	Create a default root user password.

**Table 85: Instance Name and User Account Information (Continued)**

Field	Description
Verify password	Verify the default root user password.
Operator	<p>Add an optional administrative account in addition to the root account.</p> <p>User role options include:</p> <ul style="list-style-type: none"> <li>• <b>Super User:</b> This user has full system administration rights and can add, modify, and delete settings and users.</li> <li>• <b>Operator:</b> This user can perform system operations such as a system reset but cannot change the configuration or add or modify users.</li> <li>• <b>Read only:</b> This user can only access the system and view the configuration.</li> <li>• <b>Disabled:</b> This user cannot access the system.</li> </ul>

- Select either **Time Server** or **Manual**. [Table 86 on page 513](#) lists the system time options.

**Table 86: System Time Options**

Field	Description
<b>Time Server</b>	
Host Name	Type the hostname of the time server. For example: <b>ntp.example.com</b> .
IP	Type the IP address of the time server in the IP address entry field. For example: <b>192.0.2.254</b> .

**NOTE:** You can enter either the hostname or the IP address.

**Manual**

Date	Click the current date in the calendar.
Time	Set the hour, minute, and seconds. Choose <b>AM</b> or <b>PM</b> .

Table 86: System Time Options (Continued)

Field	Description
<b>Time Zone (mandatory)</b>	
Time Zone	Select the time zone from the list. For example: GMT Greenwich Mean Time GMT.

- Expert
  - a. Select **Expert** to configure the basic options as well as the following advanced options:
    - Four or more internal zones
    - Internal zone services
    - Application of security policies between internal zones
  - b. Click the **Need Help** icon for detailed configuration information.

You see a success message after the basic configuration is complete.

## Apply the Configuration

To apply the configuration settings for vSRX Virtual Firewall:

1. Review and ensure that the configuration settings are correct, and click **Next**. The Commit Configuration page appears.
2. Click **Apply Settings** to apply the configuration changes to vSRX Virtual Firewall.
3. Check the connectivity to the vSRX Virtual Firewall instance because you might lose connectivity if you have changed the management zone IP. Click the URL for reconnection instructions on how to reconnect to the instance.
4. Click **Done** to complete the setup.

After successful completion of the setup, you are redirected to the J-Web interface.



**CAUTION:** After you complete the initial setup, you can relaunch the J-Web Setup wizard by clicking **Configuration>Setup**. You can either edit an existing configuration or create a new configuration. If you create a new configuration, the current configuration in vSRX Virtual Firewall will be deleted.

## Add vSRX Virtual Firewall Feature Licenses

Certain Junos OS software features require a license to activate the feature. To enable a licensed feature, you need to purchase, install, manage, and verify a license key that corresponds to each licensed feature. To conform to software feature licensing requirements, you must purchase one license per feature per instance. The presence of the appropriate software unlocking key on your virtual instance allows you to configure and use the licensed feature.

To understand more about vSRX Virtual Firewall Licenses, see, [Licenses for vSRX](#). Please refer to the [Licensing Guide](#) for general information about License Management. Please refer to the product [Data Sheets](#) for further details, or contact your Juniper Account Team or Juniper Partner.

## Remove a vSRX Virtual Firewall Instance from Microsoft Azure

To remove a vSRX Virtual Firewall instance from Microsoft Azure:

1. Log in to the Azure Portal.
2. In the left pane of the Azure Portal, click the Virtual Machines icon.
3. To remove the vSRX Virtual Firewall instance, in the right pane, select the vSRX Virtual Firewall instance you want to remove, then click Delete.

**NOTE:** You can delete a VM when the VM is running. If desired, you can stop the vSRX Virtual Firewall instance before deleting.

4. To delete the disks attached to the deleted vSRX Virtual Firewall virtual machine, click Delete and then select Delete the Associated VHD.
5. To delete the related cloud service for the deleted vSRX Virtual Firewall virtual machine, access the Cloud Service tab and click Delete to remove the related cloud services.

## Upgrade Junos OS Software on a vSRX Virtual Firewall Instance

### IN THIS SECTION

- [Upgrade the Junos OS for vSRX Virtual Firewall Software Release | 516](#)
- [Replace the vSRX Virtual Firewall Instance on Azure | 516](#)

This section outlines how to upgrade Junos OS software on your vSRX Virtual Firewall instance to a newer release. Depending upon your preference, you can replace the vSRX Virtual Firewall software in one of two ways:

## Upgrade the Junos OS for vSRX Virtual Firewall Software Release

You can directly upgrade the Junos OS for vSRX Virtual Firewall software using the CLI. Upgrading or downgrading Junos OS can take several hours, depending on the size and configuration of the network. You download the desired Junos OS Release for vSRX Virtual Firewall .tgz file from the [Juniper Networks website](#).

You also can upgrade using J-Web (see [J-Web](#)) or the Junos Space Network Management Platform (see [Junos Space](#)).

For the procedure on upgrading a specific Junos OS for vSRX Virtual Firewall software release, see the *Migration, Upgrade, and Downgrade Instructions* topic in the release-specific *vSRX Virtual Firewall Release Notes* available on the [vSRX TechLibrary](#).

## Replace the vSRX Virtual Firewall Instance on Azure

To replace a vSRX Virtual Firewall instance on Azure with a different software release:

1. Log in to the vSRX Virtual Firewall instance using SSH and start the CLI.

```
root@% cli
root@>
```

2. Enter configuration mode.

```
root@> configure
root@#
```

3. Copy the existing Junos OS configuration from the vSRX Virtual Firewall. The contents of the current level of the statement hierarchy (and below) are saved, along with the statement hierarchy containing it.

**NOTE:** By default, the configuration is saved to a file in your home directory.

- See [Saving a Configuration File](#) for additional background information on saving a Junos OS configuration file.

- See [file copy](#) for information on how to copy files from one location to another location on the local device or to a location on a remote device that is reachable by the local device.

```
root@#save <filename>
[edit]
root@#
```

4. Remove the vSRX Virtual Firewall instance on Azure as described in *Remove a vSRX Instance from Microsoft Azure*.
5. Once the vSRX Virtual Firewall instance on Azure has been successfully removed, define the specifics of a vSRX Virtual Firewall instance prior to launching it.
6. Launch the vSRX Virtual Firewall image using the desired software version available from Azure Marketplace.
7. Load the previously copied Junos OS configuration file onto your new (upgraded) vSRX Virtual Firewall instance as described in [Loading a Configuration File](#).

# Configure Azure Features on vSRX Virtual Firewall and Use Cases

## IN THIS CHAPTER

- [Deployment of Microsoft Azure Hardware Security Module on vSRX Virtual Firewall 3.0 | 518](#)
- [Example: Configure an IPsec VPN Between Two vSRX Virtual Firewall Instances | 538](#)
- [Example: Configure an IPsec VPN Between a vSRX Virtual Firewall and Virtual Network Gateway in Microsoft Azure | 543](#)
- [Example: Configure Juniper ATP Cloud for vSRX Virtual Firewall | 548](#)

## Deployment of Microsoft Azure Hardware Security Module on vSRX Virtual Firewall 3.0

### IN THIS SECTION

- [Microsoft Azure Key Vault Hardware Security Module Integration Overview | 519](#)
- [Configure Microsoft Azure Key Vault HSM on vSRX Virtual Firewall 3.0 | 520](#)
- [Change the Master Encryption Password | 524](#)
- [Verify the Status of the HSM | 524](#)
- [request security hsm master-encryption-password | 525](#)
- [show security hsm status | 526](#)
- [Understanding VPN Functionality with Microsoft Azure Key Vault HSM Service | 529](#)
- [CLI Behavior With and Without HSM | 533](#)
- [request security pki local-certificate enroll scep | 534](#)

## Microsoft Azure Key Vault Hardware Security Module Integration Overview

Microsoft Azure Key Vault hardware security module (HSM) is a cloud service that works as a secure secrets store. You can securely store keys, passwords, certificates, and other secrets. This service from cloud vendors helps us to securely generate, store and manage Crypto keys. vSRX Virtual Firewall applications use these Crypto keys to protect data at rest, such as private keys, passwords and other sensitive data. Azure Key Vault HSM can also be used as a Key Management solution. Azure Key Vault makes it easy to create and control the encryption keys used to encrypt your data. When you provide the master encryption password then that password is used to encrypt the sensitive data and save encrypted data (AES256) on disk. The master encryption password is also protected using RSA key-pair generated and stored in HSM.

vSRX Virtual Firewall (mgd process) generates hash of configuration. This hash (and other sensitive data) is protected using master encryption password as key for AES-GCM 256 encryption.

The master password is used to protect secrets such as the RADIUS password, IKE preshared keys, and other shared secrets in the Junos OS management process (mgd) configuration. The master password is protected using the master encryption password. The master password itself is not saved as part of the configuration. The password quality is evaluated for strength, and the device gives feedback if weak passwords are used.

Sensitive data such as PKI private keys and configuration that are stored in plain text on vSRX Virtual Firewall 3.0 instances can now be protected using HSM service.

When you enable Microsoft Azure Key Vault HSM on vSRX Virtual Firewall, vSRX Virtual Firewall creates, an RSA key pair of 2048 size and uses it to encrypt, a PKI private key file located in `/var/db/certs/common/key-pairs`, configuration hash and a master password, which is saved in: `/config/unrd-master-password.txt`.

**NOTE:** Existing keypairs prior to enabling HSM will not be encrypted and are deleted.

By enabling the HSM, the software layer leverages the use of the underlying HSM service that protects sensitive information such as private keys, system master passwords, and so on, by storing the information using 256-bit AES encryption (instead of storing in cleartext format). The device also generates a new SHA256 hash of the configuration each time the administrator commits the configuration. This hash is verified each time the system boots up. If the configuration has been tampered with, the verification fails and the device will not continue to boot. Both the encrypted data and the hash of the configuration are protected by the HSM module using the master encryption password.

Hash validation is performed during any commit operation by performing a validation check of the configuration file against the saved hash from previous commits. In a chassis cluster system, hash is independently generated on the backup system as part of the commit process.



Hash is saved only for the current configuration and not for any rollback configurations. Hash is not generated during reboot or shutdown of the device.

vSRX Virtual Firewall uses HSM to encrypt the following secrets:

- SHA256 hash of the configuration
- Device master password
- All key pairs on the device

Keys created by each vSRX Virtual Firewall 3.0 instance will be tagged and/or named using the UUID of each VM. You can log in to the cloud portal, access the keys, and verify their properties or the operations requested.

### **Configure Microsoft Azure Key Vault HSM on vSRX Virtual Firewall 3.0**

Key vault on Azure stack provides cloud HSM service for all Azure applications. All applications need to be registered in Azure active directory to use services such as Key Vault.

vSRX3.0 is integrated with Microsoft Azure Cloud HSM when running on Azure. You can login to cloud portal, access the keys, and verify their properties or operations requested for.

For each public cloud vendor, there are unique steps to be performed to integrate vSRX Virtual Firewall with cloud HSM. This section provides the steps needed to integrate vSRX Virtual Firewall 3.0 with Microsoft Azure Key Vault HSM.

You will need the following listed items to integrate vSRX Virtual Firewall with Microsoft Azure Key Vault HSM:

- vSRX Virtual Firewall 3.0 instance
- Microsoft Azure Key vault
- Setup key vault authentication for vSRX Virtual Firewall
- Microsoft Azure-specific configurations for integrating HSM

Microsoft Azure Key Vault is a cloud-hosted management service that allows users to encrypt keys and small secrets by using keys that are protected by hardware security modules (HSMs).

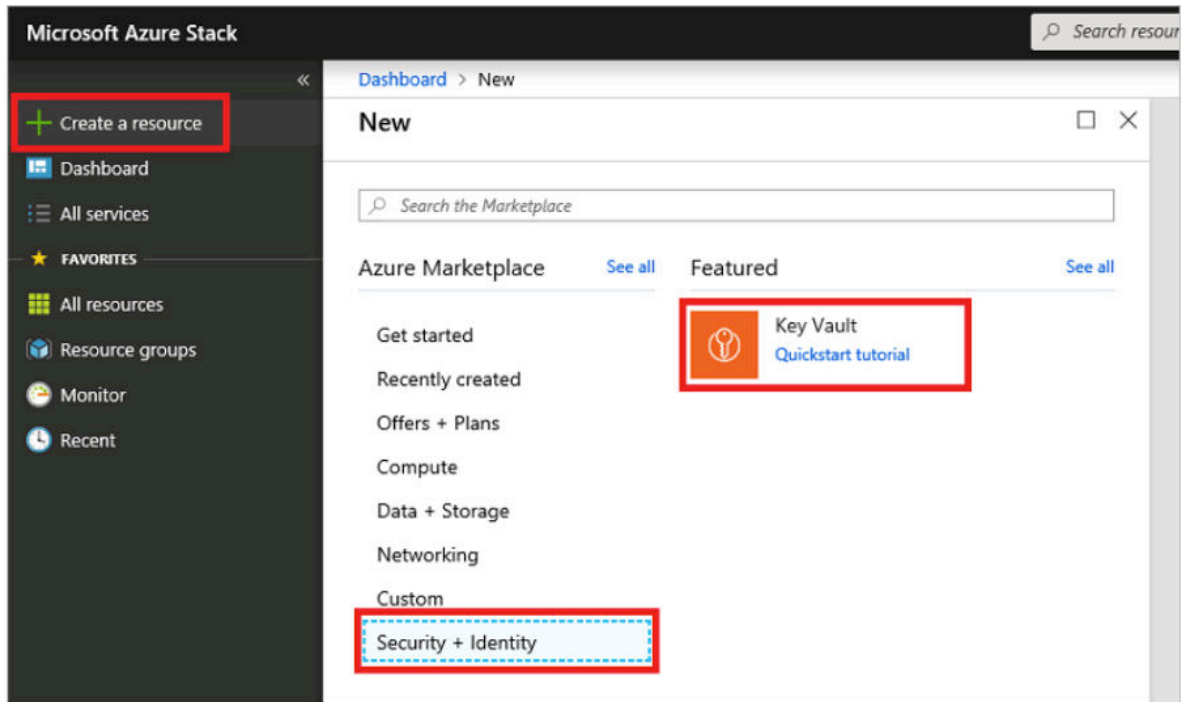
This procedure provides the general steps to integrate Microsoft Azure Key Vault HSM with vSRX Virtual Firewall 3.0.

1. Launch vSRX Virtual Firewall 3.0 instance in Microsoft Azure environment.

For launching vSRX Virtual Firewall 3.0 instances see, [vSRX Deployment Guide for Microsoft Azure Cloud](#).

2. Create Key vault. From the dashboard, select **+ Create a resource**, **Security + Identity**, and then **Key Vault** as shown in [Figure 124 on page 521](#).

Figure 124: Create Key Vault



You need to create “premium” key vault to access cryptographic key features needed by vSRX Virtual Firewall 3.0. After you create a key vault, for more information on how to create and manage keys and secrets within the vault, see [Manage Key Vault in Azure Stack using the portal](#).

3. Enable managed identity for vSRX Virtual Firewall 3.0.

System assigned managed identity helps vSRX Virtual Firewall authenticate to other services (example Key vault) without saving credentials in the code by registering your application to Azure Active directory. Enabling this identity will generate unique object ID, which can be used to refer it across other vSRX Virtual Firewall instances.

To enable managed identity for vSRX Virtual Firewall on Microsoft Azure, you need to configure managed identities for Microsoft Azure resources on a VM using the Azure portal as shown in [Figure 125 on page 522](#) and [Figure 126 on page 522](#).

For more information, see [Configure managed identities for Azure resources on a VM using the Azure portal](#)

Figure 125: Enable System Assigned Managed Identity During Creation of a VM

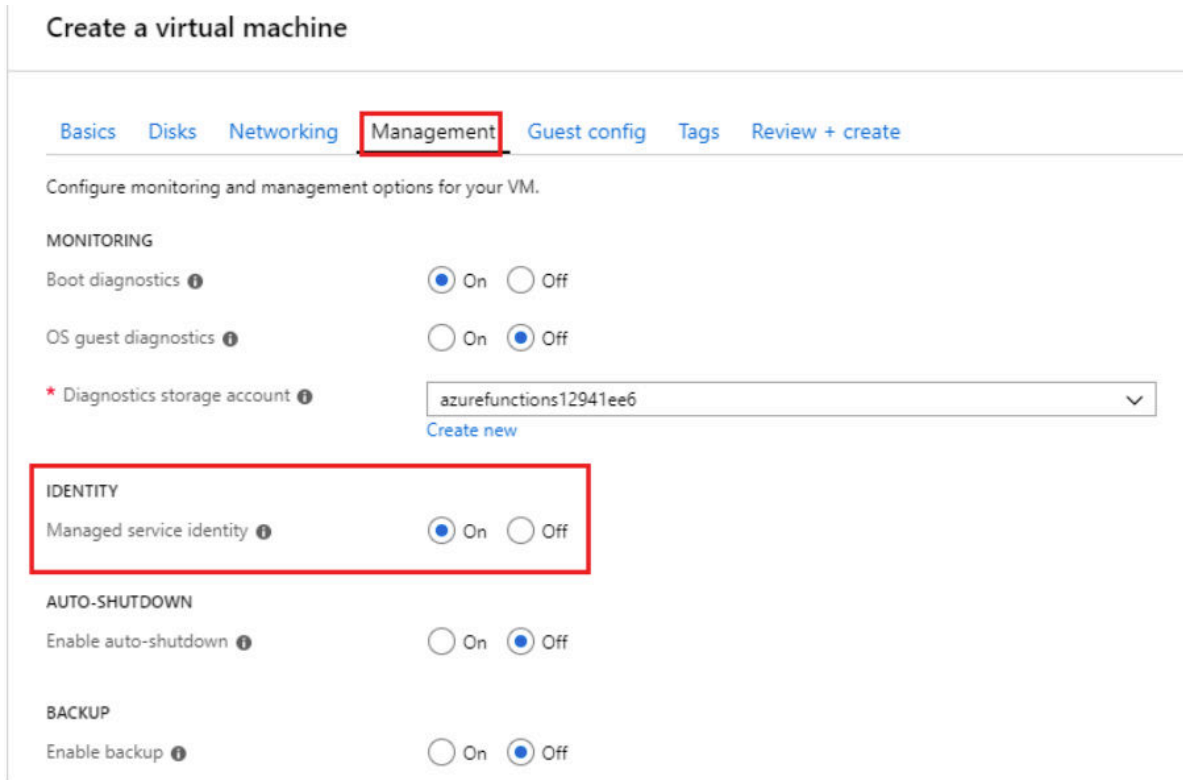
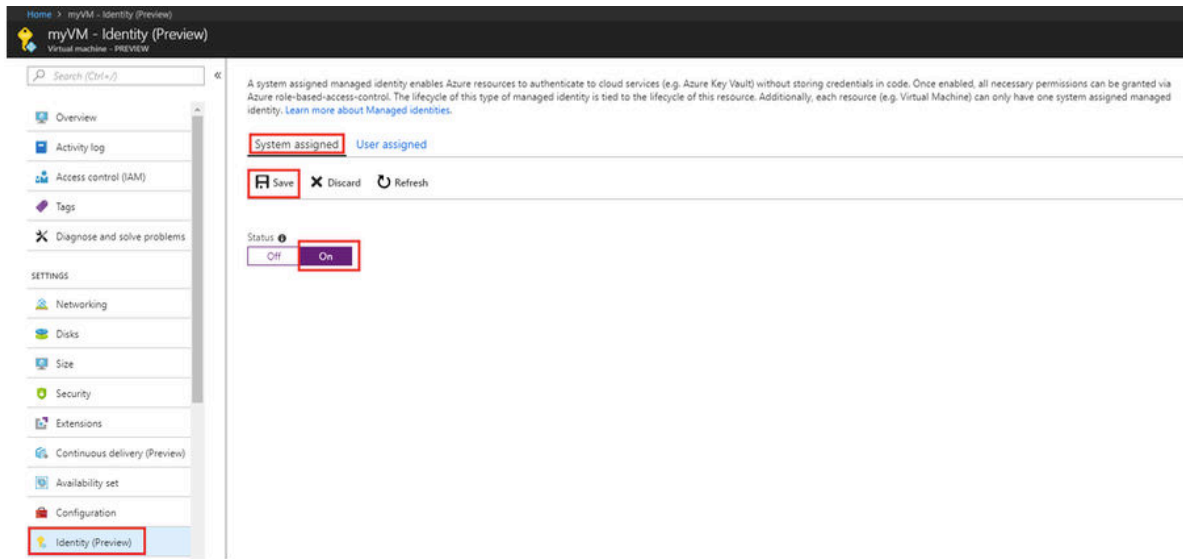


Figure 126: Enable System Assigned Managed Identity on an Existing VM



- 4. Add access policy in Microsoft Azure Key Vault.

For applications such as vSRX Virtual Firewall 3.0 VM to access Microsoft Azure Key Vault, access policies have to be enabled. For more information on how to add new policy, see [Secure access to a key vault](#) refer this link to add new policy.

Steps to add access policy in Microsoft Azure Key Vault are:

- a. Go to **Key Vault Resource** page on Microsoft Azure portal.
- b. Click **Access Policies** tab on the left side of the page.
- c. Click on **Add New** tab and then click **Select Principal**, where you search for your vSRX Virtual Firewall user name assigned when it was created.
- d. Select all the **key permissions** and click **Save**.

**NOTE:** Do not select any **Authorized application**.

#### 5. Check fxp0 (management) interface status

vSRX3.0 uses fxp0 for communication with the Microsoft Azure Key Vault. Use the `show interface terse fxp0` command and ensure to check if fxp0 is configured and is able to ping external servers.

**NOTE:** vSRX Virtual Firewall 3.0 connects to cloud HSM using management interface. If management interface is not configured or does not get connected, then cloud HSM features cannot be used.

#### 6. Enable and start communicating with key vault.

- To enable key vault, run the `request security hsm set key-vault <name-of-key-vault>` command.

**NOTE:** URL used to access Microsoft Azure Key Vault is generally in the format as: `https://<name-of-key-vault>.vault.azure.net/keys`.

- To establish communication with key vault, create RSA key pair in HSM, generate and encrypt configuration hash, and encrypt master password and PKI key pair files run the `request security hsm master-encryption-password set plain-text-password`.
- You will be prompted to enter the master encryption password twice, to make sure that these passwords match. The master encryption password is validated for required password strength. After the master encryption password is set, the system encrypts the sensitive data with the master encryption password, that is encrypted by the MEK that is owned and protected by HSM.

- To configure the master password run the `set system master-password plain-text-password` command. Otherwise, certain sensitive data will not be protected by the HSM. If HSM is not enabled, master password will be saved in plain text format in the `/config/unrd-master-password.txt` file

**NOTE:** To ensure master password is not saved as plain text on vSRX Virtual Firewall 3.0, an error will be displayed on console indicating that, it is insecure to set master password without enabling HSM and command operation will be terminated.

## Change the Master Encryption Password

If you want to change the master encryption password then you can run the `request security hsm master-encryption-password set plain-text-password` command from operational mode:

**NOTE:** It is recommended that no configuration changes are made while you are changing the master encryption password.

The system checks if the master encryption password is already configured. If master encryption password is configured, then you are prompted to enter the current master encryption password.

The entered master encryption password is validated against the current master encryption password to make sure these master encryption passwords match. If the validation succeeds, you will be prompted to enter the new master encryption password as plain text. You will be asked to enter the key twice to validate the password.

The system then proceeds to re-encrypt the sensitive data with the new master encryption password. You must wait for this process of re-encryption to complete before attempting to change the master encryption password again.

If the encrypted master encryption password file is lost or corrupted, the system will not be able to decrypt the sensitive data. The system can only be recovered by re-importing the sensitive data in clear text, and re-encrypting them.

## Verify the Status of the HSM

### IN THIS SECTION

● [Purpose | 525](#)

● [Action | 525](#)

## Purpose

To check connectivity with HSM.

## Action

You can use the `show security hsm status` command to verify the status of the HSM. The following information is displayed:

- If HSM is enabled and reachable or disabled
- Is Master Binding Key (RSA Key pair) created in HSM
- Is Master Encryption Key configured - master encryption password status (set or not set)
- Cloud vendor Information

## request security hsm master-encryption-password

### IN THIS SECTION

- [Syntax | 525](#)
- [Release Information | 525](#)
- [Description | 526](#)
- [Options | 526](#)
- [Required Privilege Level | 526](#)
- [Output Fields | 526](#)
- [Sample Output | 526](#)

## Syntax

```
request security hsm master-encryption-password set plain-text-password
```

## Release Information

Command introduced in Junos OS Release 19.4R1.

## Description

Use this command to set or replace the password (in plain text).

## Options

**plain-text-password**                      Set or replace the password (in plain text).

## Required Privilege Level

maintenance

## Output Fields

When you enter this command, you are provided feedback on the status of your request.

## Sample Output

### **request security hsm master-encryption-password set plain-text-password**

```
user@host>                      request security hsm master-encryption-password set plain-text-password
```

```
Enter new master encryption password:  
Repeat new master encryption password:  
Binding password with HSM  
Master encryption password is bound to HSM  
Encoding master password ..  
Successfully encoded master password  
Deleting all previous local certificates, keypairs and certificate requests
```

## **show security hsm status**

### IN THIS SECTION

- [Syntax | 527](#)
- [Release Information | 527](#)

- [Description | 527](#)
- [Options | 527](#)
- [Required Privilege Level | 527](#)
- [Output Fields | 527](#)
- [Sample Output | 528](#)
- [Sample Output | 529](#)

## Syntax

```
show security HSM status
```

## Release Information

Command introduced in Junos OS Release 19.4R1.

## Description

Display the current status of the Hardware Security Module (HSM). You can use this `show security hsm status` command to check the status of HSM, master binding key, master encryption password, and cloud vendor details.

## Options

This command has no options.

## Required Privilege Level

security

## Output Fields

[Table 87 on page 528](#) lists the output fields for the `show security hsm status` command.



**Table 87: show security hsm status Output Fields**

Field Name	Field Description
Enabled	Specifies whether HSM is enabled or disabled.
Master Binding Key	Displays the HSM's Master Binding Key status whether it is created or not created in HSM. HSM generates cryptographic keys and encrypts them so that those can only be decrypted by the HSM. This process is know as binding. Each HSM has a master binding key, which is also know as storage root key.
Master Encryption Key	Displays Master Encryption configuration status whether it is set or not set. The encrypted data and the hash of the configuration is protected by vSRX Virtual Firewall using Microsoft Key Vault (HSM) service.
Cloud vendor Details	Displays the details specific to the cloud vendor.

**Sample Output**

**show security hsm status (HSM status command output when vSRX Virtual Firewall initially boots up but this feature is not enabled)**

```
user@host>          show security hsm status
```

```
HSM Status:
  Accessible: no
  Master Binding Key: not-created
  Master Encryption Key: not-configured
  Azure Key Vault: unknown
```

## Sample Output

**show security hsm status** (HSM status command output after successful integration with key vault)

```
user@host> show security hsm status
```

```
HSM Status:  
  Accessible: yes  
  Master Binding Key: created  
  Master Encryption Key: configured  
  Azure Key Vault: vsrx3-hsm-kv
```

## SEE ALSO

[request security hsm master-encryption-password](#)

[Deployment of Microsoft Azure Hardware Security Module on vSRX Virtual Firewall 3.0 | 518](#)

## Understanding VPN Functionality with Microsoft Azure Key Vault HSM Service

### IN THIS SECTION

- [Deployment Scenario | 530](#)

With the integration of Microsoft Azure Key Vault HSM Service on vSRX3.0, you can now use the HSM service to create, store, and perform the required VPN keypair operations. Keypair creation is now enabled in HSM service. A PKI based VPN tunnel can now be established using the keypairs generated using the HSM. Once the master encryption key is configured, you can configure the VPN functionality using HSM service. You can generate only RSA keypairs of length 2048 and 4096 bits. Operations such as private key signing during CSR creation in PKID, private key signing during verification of the certificate received from the CA server in PKID, and private key signing during IKE negotiations at IKED is off-loaded from vSRX Virtual Firewall and is now performed by the HSM service.

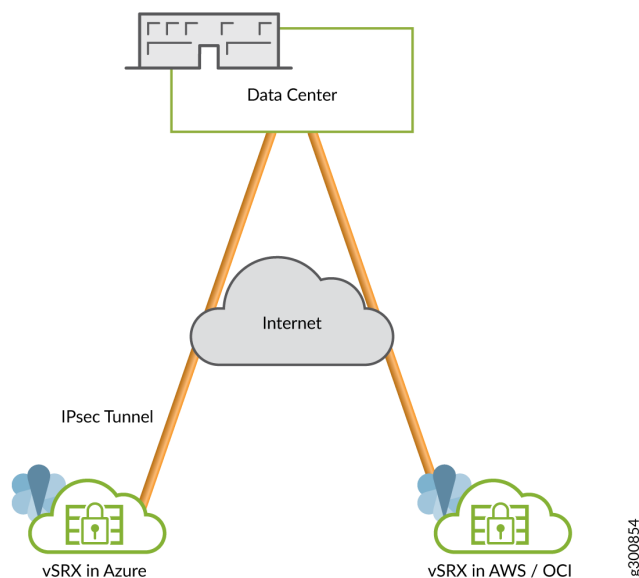
**NOTE:** Keypair generation using HSM service is only for pkid and iked processes. Also, existing keypairs in the filesystem before HSM service is enabled are not encrypted and those keypairs are deleted.

## Deployment Scenario

This section provides a deployment scenario where vSRX Virtual Firewall 3.0 instance is launched as a gateway in a virtual network connecting to a data center using a pure IPsec connection.

Figure 127 on page 530 shows the deployment scenario.

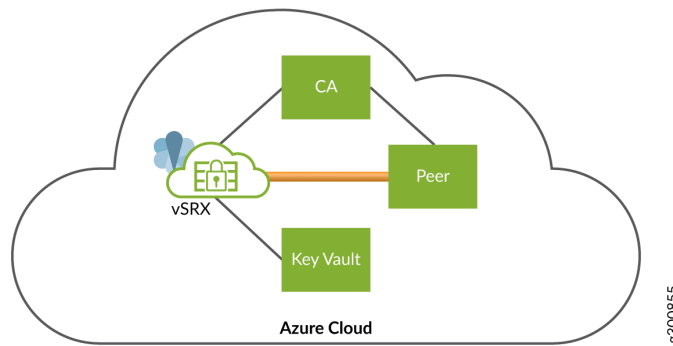
**Figure 127: Deployment Scenario of vSRX Virtual Firewall using an IPsec Connection**



You can generate key pairs using Microsoft Azure cloud HSM service for pkid process and use these keypairs for getting a local certificate from the CA server. Use the keypair present in the cloud HSM service for private key signing during IKE negotiations.

The VPN functionality performed within the Microsoft Azure cloud using HSM service is as shown in Figure 128 on page 531.

Figure 128: Components for VPN with HSM in Microsoft Azure Cloud



The components involved here are:

- vSRX Virtual Firewall 3.0 launched in the Microsoft Azure cloud.
- Peer—Second vSRX Virtual Firewall 3.0 instance launched in the Azure cloud. A tunnel is established between the first vSRX Virtual Firewall 3.0 and the Peer.
- Key Vault—The HSM service launched in the Azure cloud. You can interact between the vSRX Virtual Firewall 3.0 and the HSM, and the peer can create and store keypairs locally.
- Certificate Authority Server—Any CA server that can be accessed by the vSRX Virtual Firewall instances. The CA server is launched on the Azure Cloud.

This procedure provides steps on how to allow access from vSRX Virtual Firewall to the HSM by authenticating the vSRX Virtual Firewall with the cloud HSM service.

1. Initialize a session with the HSM service—Each process that needs to interact with the HSM has to initialize a separate session of its own. For the VPN functionality you must establish 2 sessions with the HSM service for each device involved. One session is established with pki process and another session with ikev2 process. These sessions with the HSM service are established only once during the init process of the daemon. If a daemon is restarted, a new session is established with the HSM service. When a session is successfully established with the HSM service, a valid session context is returned. Sessions will be established with the HSM service only if Master Encryption Key (MEK) is enabled. Each session will be a secure TLS connection between the vSRX Virtual Firewall and the cloud HSM.
2. Handling Keypairs at the HSM—To create and store keypairs at the HSM use the request security pki generate-key-pair certificate-id certificate-id-name <size> <type> command.

**NOTE:** The term certificate-id is just an identifier associated with the keypair that has been generated. There is no connection to a certificate creation yet. If no type and size are mentioned, then the default values of type as RSA and and size of 2048 is considered.

3. **Redirection to the HSM**—With HSM enabled, the same CLI command will be redirected to the HSM. A new keypair with the given parameters is created at the HSM. Keys created by each vSRX Virtual Firewall will be tagged using the UUID of each VM. You can login to cloud portal, access the keys and verify their properties/operations that you want. The UUID of each key is of the following format: **<key-name>\_<unique vm-instance id>**. You need to provide the key name at the time of key creation. The VM instance is the factor that will make the key id unique in the HSM service. Thus, it is required that the **vm-instance id** must be unique for each VM which is up and running. This is ensured by Microsoft Azure. The HSM redirection will be a timed call, wherein if no response is received within *x* seconds, then an error message `call to HSM failed` is displayed.
4. **Retrieval of Public Key Information**—After the creation of the keypair at the HSM, we retrieve the public key components of the keypair. The HSM returns the modulus and the exponent. These components are converted into `EVP_PKEY` structure using OpenSSL API's. The public key structure is then stored as a new entry in the hash of keys. In this way, the public key components can be retrieved from the hash when required. Currently, the HSM does not detect duplicate keypairs, instead when error key id is received again, the HSM will overwrite the pre-existing keypair. To avoid this overwrite of keypairs, the public key is saved in the hash at the time of key creation itself. This way, a duplicate keypair creation is stopped at the device level itself, without making a call to the HSM.

You will receive an error `error: Failed to generate key pair at HSM. Found a key with the same name at HSM. Use a different certificate id next time. Refer to PKID logs for more details when you try to use the same name to create a new keypair, even if you have deleted the previous keypair.`

5. **Deletion of Keypairs**—HSM does not support an API to delete keypairs created at the HSM. The `delete keypair` command issued at the CLI will result in the public key component being deleted from the disk and the key hash. The keypair will not be deleted from the HSM. To delete the keypair from the HSM, you need to access the HSM and manually delete the keypair. If Azure key vault has soft delete feature enabled, you will also need to eliminate the keypair from the keypair before you can re-use the keypair name.

**NOTE:** Exporting keys from the file is not supported. When you use the `request security pki local-certificate export` and `request security pki key-pair export` commands to export keys, you will receive an error message `Export of keypairs/certificate is not supported when HSM is enabled.`

6. **Private Key Signing**—The private key is now present at the HSM. So, all operations requiring the private key have been offloaded to the HSM. The operations involve:

Private key signing operation are used during:

- Creating the Certificate Signing Request (CSR)
- Verification of the local certificate received from the CA
- RSA signing during IKE negotiations
- SHA-1 Inter-operability. The Azure key vault supports private key signing for only SHA-256 digests.

## CLI Behavior With and Without HSM

CLI	Non-HSM	HSM
<code>request security pki generate-key-pair</code>	Creates a keypair locally	Creates a keypair at the HSM
<code>request security pki generate-certificate-request</code>	Creates a CSR locally	Contacts the HSM for private key signing while creating the CSR. Digest has to be SHA-256
<code>request security pki local-certificate enroll</code>	Creates a CSR locally. Sends the CSR to the CA server and receives a certificate	Contacts the HSM for private key signing while creating the CSR. Sends the CSR to the CA server and receives a certificate. Digest has to be SHA-256
<code>request security pki local-certificate export</code>	Exported local certificate to other device	Not possible as key pair not present locally
<code>request security pki key-pair export</code>	Exported locally present key pair to other device	Not possible as key pair not present locally
<code>request security pki local-certificate generate-self-signed</code>	Generates self signed certificate	Contacts HSM for signing and then generates self signed certificate
<code>show security pki local-certificate</code>	Shows local certificate present on device	Shows keypair is generated locally or at cloud HSM

## request security pki local-certificate enroll scep

### IN THIS SECTION

- [Syntax | 534](#)
- [Release Information | 534](#)
- [Description | 535](#)
- [Options | 535](#)
- [Required Privilege Level | 536](#)
- [Output Fields | 536](#)
- [Sample Output | 537](#)
- [Sample Output | 537](#)

### Syntax

```
request security pki local-certificate enroll scep
  ca-profile ca-profile name
  certificate-id certificate-id-name
  challenge-password challenge-password
  digest (sha-1 | sha-256)
  domain-name domain-name
  email email-address
  ip-address ip-address
  ipv6-address ipv6-address
  logical-system (logical-system-name | all)
  scep-digest-algorithm (md5 | sha-1)
  scep-encryption-algorithm (des | des3)
  subject subject-distinguished-name
```

### Release Information

Command introduced in Junos OS Release 9.1. Serial number (SN) option added to the subject string output field in Junos OS Release 12.1X45. scep keyword and ipv6-address option added in Junos OS Release 15.1X49-D40.

Starting in Junos OS Release 20.1R1 on vSRX Virtual Firewall 3.0, you can safeguard the private keys used by PKID and IKED using Microsoft Azure Key Vault hardware security module (HSM) service. You can establish a PKI based VPN tunnel using the keypairs generated at the HSM. The hub `certificate-id` option under `certificate-id` is not available for configuration after generating HSM key-pair.

Starting in Junos OS Release 20.4R1 on vSRX Virtual Firewall 3.0, you can safeguard the private keys used by PKID and IKED using AWS Key Management Service (KMS). You can establish a PKI based VPN tunnel using the keypairs generated by the KMS. The hub `certificate-id` option under `certificate-id` is not available for configuration after generating PKI key-pair.

Starting in Junos OS Release 22.4R2, `logical-system` is introduced in the statement for PKI SCEP certificate enrollment.

## Description

Enroll and install a local digital certificate online by using Simple Certificate Enrollment Protocol (SCEP).

If you enter the request `security pki local-certificate enroll` command without specifying the `scep` or `cmpv2` keyword, SCEP is the default method for enrolling a local certificate.

## Options

<b><code>ca-profile</code></b> <i>ca-profile-name</i>	CA profile name.
<b><code>certificate-id</code></b> <i>certificate-id-name</i>	Name of the local digital certificate and the public/private key pair.
<b><code>challenge-password</code></b> <i>password</i>	Password set by the administrator and normally obtained from the SCEP enrollment webpage of the CA. The password is maximum 256 characters in length. You can enforce the limit to the required characters.
<b><code>digest</code></b> ( <code>sha-1</code>   <code>sha-256</code> )	Hash algorithm used for signing RSA certificates, either SHA-1 or SHA-256. SHA-1 is the default.
<b><code>domain-name</code></b> <i>domain-name</i>	Fully qualified domain name (FQDN). The FQDN provides the identity of the certificate owner for Internet Key Exchange (IKE) negotiations and provides an alternative to the subject name.
<b><code>email</code></b> <i>email-address</i>	E-mail address of the certificate holder.
<b><code>ip-address</code></b> <i>ip-address</i>	IP address of the router.
<b><code>ipv6-address</code></b> <i>ipv6-address</i>	IPv6 address of the router for the alternate subject.



<b>logical-system</b> ( <i>logical-system-name</i>   all)	Name of the logical system or all. This is optional.
<b>scep-digest-algorithm</b> (md5   sha-1)	Hash algorithm digest, either MD5 or SHA-1; SHA-1 is the default.
<b>scep-encryption-algorithm</b> (des   des3)	Encryption algorithm, either DES or DES3; DES3 is the default.
<b>subject</b> <i>subject-distinguished-name</i>	<p>Distinguished Name (DN) format that contains the domain component, common name, department, serial number, company name, state, and country in the following format: DC, CN, OU, O, SN, L, ST, C.</p> <ul style="list-style-type: none"> <li>• DC—Domain component</li> <li>• CN—Common name</li> <li>• OU—Organizational unit name</li> <li>• O—Organization name</li> <li>• SN—Serial number of the device</li> </ul> <p>If you define SN in the subject field without the serial number, then the serial number is read directly from the device and added to the certificate signing request (CSR).</p> <ul style="list-style-type: none"> <li>• ST—State</li> <li>• C—Country</li> </ul>

### Required Privilege Level

maintenance and security

### Output Fields

When you enter this command, you are provided feedback on the status of your request.

## Sample Output

### command-name

```
user@host> request security pki local-certificate enroll scep certificate-id r3-entrust-scep ca-
profile entrust domain-name router3.example.net subject
"CN=router3,OU=Engineering,O=example,C=US" challenge-password 123
```

Certificate enrollment has started. To view the status of your enrollment, check the public key infrastructure log (pkid) log file at /var/log/pkid. Please save the challenge-password for revoking this certificate in future. Note that this password is not stored on the router.

## Sample Output

### Sample output for vSRX Virtual Firewall 3.0

```
user@host> request security pki generate-key-pair certificate-id example
```

Generated key pair example, key size 2048 bits

```
user@host> request security pki local-certificate enroll certificate-id ?
```

Possible completions:  
 <certificate-id> Certificate identifier  
 example

```
user@host> request security pki generate-key-pair certificate-id Hub
```

error: Failed to generate key pair at HSM. Found a key with the same name at HSM. Use a different certificate id next time. Refer to PKID logs for more details

## SEE ALSO

[request security pki local-certificate enroll cmpv2](#)

[show security pki local-certificate \(View\)](#)

[clear security pki local-certificate \(Device\)](#)

## RELATED DOCUMENTATION

[What is Azure Key Vault?](#)

# Example: Configure an IPsec VPN Between Two vSRX Virtual Firewall Instances

## IN THIS SECTION

- [Before You Begin | 538](#)
- [Overview | 538](#)
- [vSRX Virtual Firewall IPsec VPN Configuration | 539](#)
- [Verification | 542](#)

This example shows how to configure an IPsec VPN between two instances of vSRX Virtual Firewall in Microsoft Azure.

## Before You Begin

Ensure that you have installed and launched a vSRX Virtual Firewall instance in Microsoft Azure virtual network.

See [SRX Site-to-Site VPN Configuration Generator](#) and [How to troubleshoot a VPN tunnel that is down or not active](#) for additional information.

## Overview

You can use an IPsec VPN to secure traffic between two VNETs in Microsoft Azure using two vSRX Virtual Firewall instances.

## vSRX Virtual Firewall IPsec VPN Configuration

### IN THIS SECTION

- [vSRX1 VPN Configuration | 539](#)
- [vSRX2 VPN Configuration | 541](#)

### vSRX1 VPN Configuration

#### Step-by-Step Procedure

To configure IPsec VPN on vSRX1:

1. Log in to the vSRX1 in configuration edit mode (see *Configure vSRX Using the CLI*).
2. Set the IP addresses for vSRX1 interfaces.

```
set interfaces ge-0/0/0 unit 0 family inet address 10.0.0.10/24
set interfaces ge-0/0/1 unit 0 family inet address 10.10.10.10/24
set interfaces st0 unit 1 family inet address 10.0.250.10/24
```

3. Set up the untrust security zone.

```
set security zones security-zone untrust screen untrust-screen
set security zones security-zone untrust host-inbound-traffic system-services ike
set security zones security-zone untrust interfaces ge-0/0/0.0
set security zones security-zone untrust interfaces st0.1
```

4. Set up the trust security zone.

```
set security zone trust host-inbound-traffic system-services https
set security zone trust host-inbound-traffic system-services ssh
set security zone trust host-inbound-traffic system-services ping
set security security-zone trust interfaces ge-0/0/1.0
```

## 5. Configure IKE.

```

set security ike proposal ike-phase1-proposalA authentication-method pre-shared-keys
set security ike proposal ike-phase1-proposalA dh-group group2
set security ike proposal ike-phase1-proposalA authentication-algorithm sha-256
set security ike proposal ike-phase1-proposalA encryption-algorithm aes-256-cbc
set security ike proposal ike-phase1-proposalA lifetime-seconds 1800
set security ike policy ike-phase1-policyA mode aggressive
set security ike policy ike-phase1-policyA proposals ike-phase1-proposalA
set security ike policy ike-phase1-policyA pre-shared-key ascii-text <preshared-key>
set security ike gateway gw-siteB ike-policy ike-phase1-policyA
set security ike gateway gw-siteB address 198.51.100.10
set security ike gateway gw-siteB local-identity user-at-hostname "source@example.net"
set security ike gateway gw-siteB remote-identity user-at-hostname "dest@example.net"
set security ike gateway gw-siteB external-interface ge-0/0/0.0

```

**NOTE:** Be sure to replace 198.51.100.10 in this example with the correct public IP address.

## 6. Configure IPsec.

```

set security ipsec proposal ipsec-proposalA protocol esp
set security ipsec proposal ipsec-proposalA authentication-algorithm hmac-sha1-96
set security ipsec proposal ipsec-proposalA encryption-algorithm aes-256-cbc
set security ipsec policy ipsec-policy-siteB proposals ipsec-proposalA
set security ipsec vpn ike-vpn-siteB bind-interface st0.1
set security ipsec vpn ike-vpn-siteB ike gateway gw-siteB
set security ipsec vpn ike-vpn-siteB ike ipsec-policy ike-phase1-policyA
set security ipsec vpn ike-vpn-siteB establish-tunnels immediately

```

## 7. Configure routing.

```

set routing-instances siteA-vr1 instance-type virtual-router
set routing-instances siteA-vr1 interface ge-0/0/0.0
set routing-instances siteA-vr1 interface ge-0/0/1.0
set routing-instances siteA-vr1 interface st0.1
set routing-instances siteA-vr1 routing-options static route 0.0.0.0/0 next-hop 10.0.0.1
set routing-instances siteA-vr1 routing-options static route 10.20.20.0/24 next-hop st0.1
commit

```

## vSRX2 VPN Configuration

### Step-by-Step Procedure

To configure IPsec VPN on vSRX2:

1. Log in to the vSRX2 in configuration edit mode (See *Configure vSRX Using the CLI*).
2. Set the IP addresses for the vSRX2 interfaces.

```
set interfaces ge-0/0/0 unit 0 family inet address 10.1.0.10/24
set interfaces ge-0/0/1 unit 0 family inet address 10.20.20.10/24
set interfaces st0 unit 1 family inet address 10.0.250.20/24
```

3. Set up the untrust security zone.

```
set security zones security-zone untrust screen untrust-screen
set security zones security-zone untrust host-inbound-traffic system-services ike
set security zones security-zone untrust interfaces ge-0/0/0.0
set security zones security-zone untrust interfaces st0.1
```

4. Set up the trust security zone.

```
set security zones security-zone trust host-inbound-traffic system-services https
set security zones security-zone trust host-inbound-traffic system-services ssh
set security zones security-zone trust host-inbound-traffic system-services ping
set security zones security-zone trust interfaces ge-0/0/1.0
```

5. Configure IKE.

```
set security ike proposal ike-phase1-proposalA authentication-method pre-shared-keys
set security ike proposal ike-phase1-proposalA dh-group group2
set security ike proposal ike-phase1-proposalA authentication-algorithm sha-256
set security ike proposal ike-phase1-proposalA encryption-algorithm aes-256-cbc
set security ike proposal ike-phase1-proposalA lifetime-seconds 1800
set security ike policy ike-phase1-policyA mode aggressive
set security ike policy ike-phase1-policyA proposals ike-phase1-proposalA
set security ike policy ike-phase1-policyA pre-shared-key ascii-text preshared-key
set security ike gateway gw-siteB ike-policy ike-phase1-policyA
set security ike gateway gw-siteB address 203.0.113.10
```

```

set security ike gateway gw-siteB local-identity user-at-hostname "dest@example.net"
set security ike gateway gw-siteB remote-identity user-at-hostname "source@example.net"
set security ike gateway gw-siteB external-interface ge-0/0/0.0

```

**NOTE:** Be sure to replace 203.0.113.10 in this example with the correct public IP address. Also note that the SiteB local-identity and remote-identity should be in contrast with the SiteA local-identity and remote-identity.

## 6. Configure IPsec.

```

set security ipsec proposal ipsec-proposalA protocol esp
set security ipsec proposal ipsec-proposalA authentication-algorithm hmac-sha1-96
set security ipsec proposal ipsec-proposalA encryption-algorithm aes-256-cbc
set security ipsec policy ipsec-policy-siteB proposals ipsec-proposalA
set security ipsec vpn ike-vpn-siteB bind-interface st0.1
set security ipsec vpn ike-vpn-siteB ike gateway gw-siteB
set security ipsec vpn ike-vpn-siteB ike ipsec-policy ike-phase1-policyA
set security ipsec vpn ike-vpn-siteB establish-tunnels immediately

```

## 7. Configure routing.

```

set routing-instances siteA-vr1 instance-type virtual-router
set routing-instances siteA-vr1 interface ge-0/0/0.0
set routing-instances siteA-vr1 interface ge-0/0/1.0
set routing-instances siteA-vr1 interface st0.1
set routing-instances siteA-vr1 routing-options static route 0.0.0.0/0 next-hop 10.0.0.1
set routing-instances siteA-vr1 routing-options static route 10.20.20.0/24 next-hop st0.1
commit

```

## Verification

### IN THIS SECTION

- [Verify Active VPN Tunnels | 543](#)

## Verify Active VPN Tunnels

### Purpose

Verify that the tunnel is up on both vSRX Virtual Firewall instances.

### Action

```
root@> show security ipsec security-associations
```

```
Total active tunnels: 1
ID      Algorithm          SPI      Life:sec/kb  Mon lsys Port  Gateway
<131074 ESP:aes--cbc--256/sha1 de836105 1504/ unlim -- root 4500 52.200.89.XXX
>131074 ESP:aes--cbc--256/sha1 b349bc84 1504/ unlim -- root 4500 52.200.89.XXX
```

## RELATED DOCUMENTATION

[IPsec VPN Overview](#)

[Application Firewall Overview](#)

## Example: Configure an IPsec VPN Between a vSRX Virtual Firewall and Virtual Network Gateway in Microsoft Azure

### IN THIS SECTION

- [Before You Begin | 544](#)
- [Overview | 544](#)
- [vSRX Virtual Firewall IPsec VPN Configuration | 544](#)
- [Microsoft Azure Virtual Network Gateway Configuration | 546](#)

This example shows how to configure an IPsec VPN between a vSRX Virtual Firewall instance and a virtual network gateway in Microsoft Azure.



## Before You Begin

Ensure that you have installed and launched a vSRX Virtual Firewall instance in Microsoft Azure virtual network.

See [SRX Site-to-Site VPN Configuration Generator](#) and [How to troubleshoot a VPN tunnel that is down or not active](#) for additional information.

## Overview

You can use an IPsec VPN to secure traffic between two VNets in Microsoft Azure, with one vSRX Virtual Firewall protecting one VNet and the Azure virtual network gateway protecting the other VNet.

## vSRX Virtual Firewall IPsec VPN Configuration

### IN THIS SECTION

- [Procedure | 544](#)

## Procedure

### Step-by-Step Procedure

To configure IPsec VPN on vSRX Virtual Firewall:

1. Log in to the vSRX Virtual Firewall in configuration edit mode (see *Configure vSRX Using the CLI*).
2. Set the IP addresses for vSRX Virtual Firewall interfaces.

```
set interfaces ge-0/0/0 unit 0 family inet address 10.0.0.10/24
set interfaces ge-0/0/1 unit 0 family inet address 10.10.10.10/24
set interfaces st0 unit 1 family inet address 10.0.250.10/24
```

3. Set up the untrust security zone.

```
set security zones security-zone untrust screen untrust-screen
set security zones security-zone untrust host-inbound-traffic system-services ike
set security zones security-zone untrust interfaces ge-0/0/0.0
set security zones security-zone untrust interfaces st0.1
```

#### 4. Set up the trust security zone.

```
set security zone trust host-inbound-traffic system-services https
set security zone trust host-inbound-traffic system-services ssh
set security zone trust host-inbound-traffic system-services ping
set security security-zone trust interfaces ge-0/0/1.0
```

#### 5. Configure IKE.

```
set security ike proposal ike-phase1-proposalA authentication-method pre-shared-keys
set security ike proposal ike-phase1-proposalA dh-group group2
set security ike proposal ike-phase1-proposalA authentication-algorithm sha-256
set security ike proposal ike-phase1-proposalA encryption-algorithm aes-256-cbc
set security ike policy ike-phase1-policyA mode main
set security ike policy ike-phase1-policyA proposals ike-phase1-proposalA
set security ike policy ike-phase1-policyA pre-shared-key ascii-text <preshared-key>
set security ike gateway gw-siteB ike-policy ike-phase1-policyA
set security ike gateway gw-siteB address 52.175.210.65
set security ike gateway gw-siteB version v2-only
set security ike gateway gw-siteB external-interface ge-0/0/0.0
```

**NOTE:** Be sure to replace 52.175.210.65 in this example with the correct public IP address.

#### 6. Configure IPsec.

The following example illustrates a vSRX Virtual Firewall IPsec configuration using the CBC encryption algorithm:

```
set security ipsec proposal ipsec-proposalA protocol esp
set security ipsec proposal ipsec-proposalA authentication-algorithm hmac-sha1-96
set security ipsec proposal ipsec-proposalA encryption-algorithm aes-256-cbc
set security ipsec proposal ipsec-proposalA lifetime-seconds 7200
set security ipsec proposal ipsec-proposalA lifetime-kilobytes 102400000

set security ipsec policy ike-phase1-policyA proposals ipsec-proposalA
set security ipsec vpn ike-vpn-siteB bind-interface st0.1
set security ipsec vpn ike-vpn-siteB ike gateway gw-siteB
```

```
set security ipsec vpn ike-vpn-siteB ike ipsec-policy ike-phase1-policyA
set security ipsec vpn ike-vpn-siteB establish-tunnels immediately
```

If required, you can use AES-GCM as the encryption algorithm in the vSRX Virtual Firewall IPsec configuration instead of CBC:

```
set security ipsec proposal ipsec-proposalA protocol esp
set security ipsec proposal ipsec-proposalA encryption-algorithm aes-256-gcm
set security ipsec proposal ipsec-proposalA lifetime-seconds 7200
set security ipsec proposal ipsec-proposalA lifetime-kilobytes 102400000

set security ipsec policy ike-phase1-policyA proposals ipsec-proposalA
set security ipsec vpn ike-vpn-siteB bind-interface st0.1
set security ipsec vpn ike-vpn-siteB ike gateway gw-siteB
set security ipsec vpn ike-vpn-siteB ike ipsec-policy ike-phase1-policyA
set security ipsec vpn ike-vpn-siteB establish-tunnels immediately
```

## 7. Configure routing.

```
set routing-instances siteA-vr1 instance-type virtual-router
set routing-instances siteA-vr1 interface ge-0/0/0.0
set routing-instances siteA-vr1 interface ge-0/0/1.0
set routing-instances siteA-vr1 interface st0.1
set routing-instances siteA-vr1 routing-options static route 0.0.0.0/0 next-hop 10.0.0.1
set routing-instances siteA-vr1 routing-options static route 10.20.20.0/24 next-hop st0.1
commit
```

## Microsoft Azure Virtual Network Gateway Configuration

### IN THIS SECTION

- [Procedure | 547](#)

## Procedure

### Step-by-Step Procedure

1. To configure the Microsoft Azure virtual network gateway, refer to the following Microsoft Azure procedure:

[Configure IPsec/IKE policy for S2S VPN or VNet-to-VNet connections](#)

Ensure the IPsec IKE parameters in Microsoft Azure virtual network gateway match the vSRX Virtual Firewall IPsec IKE parameters when the site-to-site VPN connection is formed.

2. Verify Active VPN Tunnels.

Verify that the tunnel is up between the vSRX Virtual Firewall instance and the Azure virtual network gateway.

```
root@> show security ike security-associations
```

Index	State	Initiator cookie	Responder cookie	Mode	Remote Address
8290401	UP	b1adf15fc3dfe0b0	89cc2a12cb7e3cd7	IKEv2	52.175.210.65

```
root@> show security ipsec security-associations
```

```
Total active tunnels: 1
```

ID	Algorithm	SPI	Life:sec/kb	Mon	lsys	Port	Gateway
<131073	ESP:aes-gcm-256/None	c0e154e2	5567/	102399997	- root	4500	52.175.210.65
>131073	ESP:aes-gcm-256/None	383bd606	5567/	102399997	- root	4500	52.175.210.65

## RELATED DOCUMENTATION

[IPsec VPN Overview](#)

[Application Firewall Overview](#)

## Example: Configure Juniper ATP Cloud for vSRX Virtual Firewall

### IN THIS SECTION

- [Before You Begin | 548](#)
- [Overview | 548](#)
- [Juniper ATP Cloud Configuration | 548](#)

This example shows how to configure Juniper ATP Cloud on a vSRX Virtual Firewall instance that is deployed in a virtual private cloud (VPC).

### Before You Begin

Ensure that you have installed and launched a vSRX Virtual Firewall instance in a VPC.

### Overview

You can use Juniper ATP Cloud, a cloud-based solution, along with vSRX Virtual Firewall to protect all hosts in your network against evolving security threats.

### Juniper ATP Cloud Configuration

#### IN THIS SECTION

- [Procedure | 548](#)

### Procedure

#### Step-by-Step Procedure

To configure Juniper ATP Cloud on a vSRX Virtual Firewall instance:

1. Log in to the vSRX Virtual Firewall instance using SSH and start the CLI.

```
root@% cli
root@>
```

2. Enter configuration mode.

```
root@> configure
[edit]
root@#
```

3. Set up the correct data interface for the active advanced antimalware (AAMW) service instead of using the default fxp0 interface.

```
root@# set services advanced-anti-malware connection source-interface ge-0/0/0.0
```

4. Configure NAT.

```
root@# set security nat source rule-set rs1 from zone trust
root@# set security nat source rule-set rs1 to zone untrust
root@# set security nat source rule-set rs1 rule r1 match source-address 0.0.0.0/0
root@# set security nat source rule-set rs1 rule r1 match destination-address 0.0.0.0/0
root@# set security nat source rule-set rs1 rule r1 then source-nat interface
```

5. Set up virtual routing instance for the correct data interface for AAMW service.

```
root@# set routing-instances vsrx-vr1 instance-type virtual-router
root@# set routing-instances vsrx-vr1 routing-options static route 0.0.0.0/0 next-hop 10.4.1.1
root@# set routing-instances vsrx-vr1 interface ge-0/0/0.0
root@# set routing-instances vsrx-vr1 interface ge-0/0/1.0
```

6. Verify the configuration.

```
root@# commit check
configuration check succeeds
```

7. Commit the configuration to activate it on the vSRX Virtual Firewall instance.

```
root@# commit
commit complete
```

8. Optionally, you can verify the configuration by running the following show commands in the configuration mode:
  - show services advanced-anti-malware connection | display set
  - show security nat | display set
  - show routing-instances vsrx-vr1 | display set

## RELATED DOCUMENTATION

| [Juniper Advanced Threat Prevention Cloud Administration Guide](#)



# vSRX Virtual Firewall Deployment for Google Cloud Platform

---

[Overview | 552](#)

[Install vSRX Virtual Firewall in Google Cloud | 560](#)

---



# Overview

## IN THIS CHAPTER

- [Understand vSRX Virtual Firewall Deployment with Google Cloud | 552](#)
- [Requirements for vSRX Virtual Firewall on Google Cloud Platform | 555](#)

## Understand vSRX Virtual Firewall Deployment with Google Cloud

### IN THIS SECTION

- [Understand vSRX Virtual Firewall Deployment with Google Cloud Platform | 552](#)

## Understand vSRX Virtual Firewall Deployment with Google Cloud Platform

### IN THIS SECTION

- [Manage Access to Instances | 554](#)
- [Access Instances | 555](#)

Google Cloud Platform (GCP) is a public cloud service provided by Google. Like Amazon Web Service (AWS) and Microsoft Azure, GCP offers a suite of products and services that allow you to build and host applications and websites, store data, and analyze data on Google's scalable infrastructure. A pay-as-you-go model is delivered and saves you from building your own private cloud using dedicated hardware.

Google's virtual private cloud (VPC) gives you the flexibility to scale and control how workloads connect regionally and globally. When you connect your on-premises or remote resources to GCP, you will have

global access to your VPCs without needing to replicate connectivity or administrative policies in each region.

vSRX Virtual Firewall in a public cloud can be used for protecting service VMs from public Internet or protecting VMs in different subnets, or used as VPN Gateways.

Like AWS, GCP allows you to build your own VPCs on top of Google's public infrastructure. Unlike AWS, GCP uses KVM instead of modified Xen as the hypervisor for VM management.

In a Google cloud, vSRX Virtual Firewall instances run on top of Google VPCs. A Google VPC has the following properties:

- Provides a global private communication space.
- Supports multitenancy in an organization.
- Provides private communication between Google Cloud Platform (GCP) resources, such as Computing Engine and Cloud Storage.
- Provides security for configuration access using identify and access management (IAM).
- Extensible across hybrid environments.

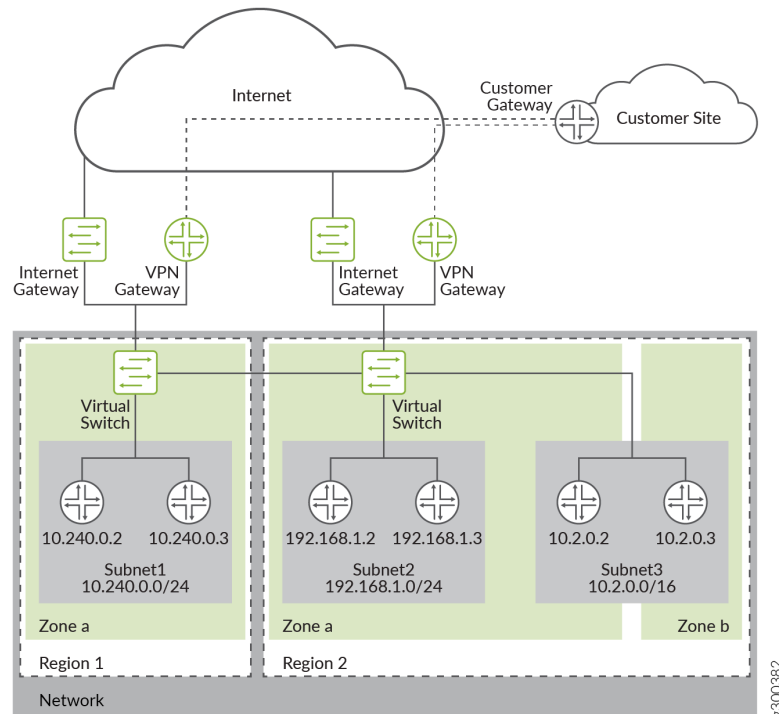
When you create a resource in GCP, you choose a network and subnet. For resources other than instance templates, you also select a zone or a region. Selecting a zone implicitly selects its parent region. Because subnets are regional objects, the region you select for a resource determines the subnets it can use.

The process of creating an instance involves selecting a zone, a network, and a subnet. The subnets available for selection are restricted to those in the selected region. GCP assigns the instance an IP address from the range of available addresses in the subnet.

The process of creating a managed instance group involves selecting a zone or region, depending on the group type, and an instance template. The instance templates available for selection are restricted to those whose defined subnets are in the same region selected for the managed instance group. Instance templates are global resources. The process of creating an instance template involves selecting a network and a subnet. If you select an auto-mode network, you can choose "auto subnet" to defer subnet selection to one that is available in the selected region of any managed instance group that would use the template, because auto-mode networks have a subnet in every region by definition.

An example of a typical Google VPC is shown in [Figure 129 on page 554](#).

Figure 129: Example of a Google VPC



The vSRX Virtual Firewall instance is launched with multiple virtual interfaces in VPC subnets. The first interface (fxp0) will be the management interface. It is connected to the Internet gateway for public access. You can use SSH to access the interface and manage the virtual device with Junos CLI, just as you can with SRX Series Firewalls. The subsequent interfaces are revenue ports. They are managed by the flowd process running on Linux and handle all the traffic. On GCP, a maximum of 8 network interfaces are allowed per vSRX Virtual Firewall instance.

Some of the initial provisioning parameters for first boot are host name, root password, SSH public key, management interface (fxp0) IP address, and default gateway IP address.

Starting in Junos OS Release 19.2R1, vSRX Virtual Firewall instances with 2 vCPUs, 4-GB memory, and 19-GB disk space are supported on GCP.

### Manage Access to Instances

To create and manage instances, you can use a variety of tools, including the Google Cloud Platform Console, the gcloud command-line tool, and the REST API. To configure applications on your instances, connect to the instance using SSH for Linux instances.

You can manage access to your instances using one of the following methods:

- **Linux instance:**

- Manage instance access using OS login, which allows you to associate SSH keys with your Google account or G Suite account and manage administrator or non-administrator access to instances through identity and access management (IAM) roles. If you connect to your instances using the `gcloud` command-line tool or SSH from the console, Compute Engine can automatically generate SSH keys for you and apply them to your Google account or G Suite account.
- Manage your SSH keys in project or instance metadata, which grants administrator access to instances with metadata access that do not use OS Login. If you connect to your instances using the `gcloud` command-line tool or SSH from the console, Compute Engine can automatically generate SSH keys for you and apply them to project metadata.
- **Windows Server instances**—Create a password for a Windows Server instance.

### Access Instances

After you configure access to your instances, you can connect to your instances using one of several options. For more information about connecting your instances, see [Connecting to instances](#).

## Requirements for vSRX Virtual Firewall on Google Cloud Platform

### IN THIS SECTION

- [Google Compute Engine Instance Types | 555](#)
- [vSRX Virtual Firewall Support for Google Cloud | 556](#)
- [vSRX Virtual Firewall Specifications for GCP | 557](#)

### Google Compute Engine Instance Types

To create a vSRX Virtual Firewall instance, you need to choose a machine type. The machine type specifies a particular collection of virtualized hardware resources available to a VM instance, including the memory size, vCPU count, and maximum disk capacity.

Google Compute Engine allows you to use predefined machine or instances types or customized machine or instance types based on your needs. [Table 88 on page 556](#) below shows the predefined machine types available in Google Compute Engine.

**Table 88: Google Compute Engine Instance Types**

Machine Name	Description	vCPUs	Memory (GB)	vSRX Virtual Firewall 3.0 Instance	Maximum number of Persistent Disks	Maximum total Persistent Disk Size (TB)	RSS Type
n1-standard-4	Standard machine type with 4 vCPUs and 15 GB of memory	4	15	vSRX Virtual Firewall-4CPU-15G memory	16	64	SWRSS
n1-standard-8	Standard machine type with 8 vCPUs and 30 GB of memory	8	30	vSRX Virtual Firewall-8CPU-30G memory	16	64	SWRSS
n1-standard-16	Standard machine type with 16 vCPUs and 60 GB of memory	16	60	vSRX Virtual Firewall-16CPU-60G memory	16	64	SWRSS

A single Google Compute Engine instance supports up to eight network interfaces. If you want to configure eight interfaces, choose n1-standard-8 or a larger machine type. After choosing the machine type, define the networking attributes and SSH Keys for the VM. For more information on network interfaces, see [Creating instances with multiple network interfaces](#).

### vSRX Virtual Firewall Support for Google Cloud

Starting in Junos OS Release 19.2R1, vSRX Virtual Firewall with 1 Junos Control Plane (JCP) vCPU, 1 data plane vCPU, and 4 GB of vRAM is supported.

## vSRX Virtual Firewall Specifications for GCP

### IN THIS SECTION

- [Minimum System Requirements for Google Cloud Platform | 557](#)
- [Interface Mapping for vSRX Virtual Firewall on Google Cloud | 558](#)
- [vSRX Virtual Firewall Default Settings on GCP | 559](#)

This topic provides details about hardware and software requirements for deploying vSRX Virtual Firewall with Google.

### Minimum System Requirements for Google Cloud Platform

[Table 89 on page 557](#) lists the minimum system requirements and the Junos OS release in which a particular software specification was introduced for vSRX Virtual Firewall instances to be deployed on GCP.

**Table 89: Minimum System Requirements for vSRX Virtual Firewall on GCP**

Component	Specification	Release Introduced
Memory	4 GB	Junos OS Release 19.2R1
Disk space	19-GB IDE drive	Junos OS Release 19.2R1
vCPUs	1 Junos Control Plane (JCP) vCPU and 1 data plane vCPU	Junos OS Release 19.2R1
vNICs	2-8 vNICs <ul style="list-style-type: none"> <li>● Virtio</li> <li>● SR-IOV is not supported by GCP.</li> </ul>	Junos OS Release 19.2R1
Software feature license	For more information, see <a href="#">Flex Software Subscription Model</a> and <a href="#">Juniper Flex Program Support for Juniper Products</a> .	NA

**Table 89: Minimum System Requirements for vSRX Virtual Firewall on GCP (Continued)**

Component	Specification	Release Introduced
Software packaging	<p>Google Compute Engine has specific requirements for the bootable image that is imported to Google cloud space. For more information, see <a href="https://cloud.google.com/compute/docs/images/import-existing-image#create_image_file">https://cloud.google.com/compute/docs/images/import-existing-image#create_image_file</a>.</p> <p>For initial deployment, the .img file is used and for software upgrade, the .tgz image is used.</p>	NA

### Interface Mapping for vSRX Virtual Firewall on Google Cloud

Each network adapter defined for a vSRX Virtual Firewall is mapped to a specific interface, depending on whether the vSRX Virtual Firewall instance is a standalone VM or one of a cluster pair for high availability. The interface names and mappings in vSRX Virtual Firewall are shown in [Table 90 on page 558](#).

Note the following:

- In standalone mode:
  - fxp0 is the out-of-band management interface.
  - ge-0/0/0 is the first traffic (revenue) interface.

[Table 90 on page 558](#) shows the interface names and mappings for a standalone vSRX Virtual Firewall on Google cloud.

**Table 90: Interface Names for a Standalone vSRX Virtual Firewall on GCP**

Network Adapter	Interface Name in Junos OS for vSRX Virtual Firewall
1	fxp0
2	ge-0/0/0
3	ge-0/0/1

**Table 90: Interface Names for a Standalone vSRX Virtual Firewall on GCP (Continued)**

Network Adapter	Interface Name in Junos OS for vSRX Virtual Firewall
4	ge-0/0/2
5	ge-0/0/3
6	ge-0/0/4
7	ge-0/0/5
8	ge-0/0/6

**vSRX Virtual Firewall Default Settings on GCP**

vSRX Virtual Firewall requires the following basic configuration settings:

- Interfaces must be assigned IP addresses.
- Interfaces must be bound to zones.
- Policies must be configured between zones to permit or deny traffic.

[Table 91 on page 559](#) lists the factory-default settings for security policies on the vSRX Virtual Firewall instance.

**Table 91: Factory-Default Settings for Security Policies**

Source Zone	Destination Zone	Policy Action
trust	untrust	permit
trust	trust	permit
untrust	trust	deny



# Install vSRX Virtual Firewall in Google Cloud

## IN THIS CHAPTER

- Prepare to setup vSRX Virtual Firewall Deployment on GCP | 560
- Deploy vSRX Virtual Firewall in Google Cloud Platform | 566
- Upgrade the Junos OS for vSRX Virtual Firewall Software Release | 583
- Secure Data with vSRX Virtual Firewall 3.0 Using GCP KMS (HSM) | 584

## Prepare to setup vSRX Virtual Firewall Deployment on GCP

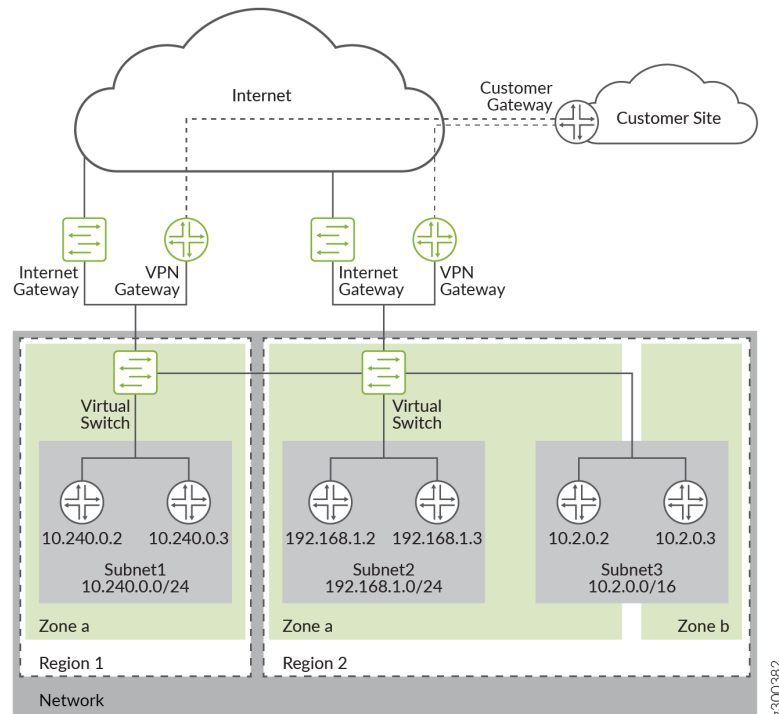
### IN THIS SECTION

- Step 1: Google Cloud Platform Account Planning | 562
- Step 2: Define Network Attributes and Generate SSH Key Pair for Authentication | 563
- Step 3: Plan Google Virtual Private Cloud (VPC) Network | 565

Before you begin, you need a Google account and an identity and access management (IAM) role, with all required permissions to access, create, modify, and delete Compute Engine Instances and Storage Service, and Google's VPC objects. You should also create access keys and corresponding secret access keys, certificates, and account identifiers.

[Figure 130 on page 561](#) shows an example of how you can deploy vSRX Virtual Firewall to provide security for applications running in a private subnet of Google VPC.

Figure 130: Example of a Google VPC



You need to set up the vSRX Virtual Firewall 3.0 Firewall on Google Cloud Platform to deploy a vSRX Virtual Firewall 3.0 firewall on a Google Cloud Computer Engine instance on the Google Cloud Platform (GCP).

Before you deploy vSRX Virtual Firewall 3.0, you must create your project networks and subnetworks, and plan networks and IP address assignments for the vSRX Virtual Firewall interfaces. During the deployment, you must choose from the existing networks and subnetworks.

**Subnetworks**—You must create subnetworks in each VPC networks in specific region in which you plan to deploy the vSRX Virtual Firewall. A VPC Networks can add subnetworks in different region. These subnetworks are all internal network in GCP.

- **IP Address**—You need to assign IP address ranges when you create interface subnetworks.
- **Range**—The range for a network subnet cannot overlap with others.
- **External IP Address**—During vSRX Virtual Firewall deployment you can choose to enable or disable an external IP address when you create a network interface for the vSRX Virtual Firewall, by default, an ephemeral IP address is auto-assigned. You can also specify a static address when creating a network interface.
- **Management Interface**—The first network interface added to a vSRX Virtual Firewall is mapped to fxp0 on the vSRX Virtual Firewall.

- Enable IP forwarding
- This interface has an external IP address.
- On vSRX Virtual Firewall, DHCP is enabled to fxp0 by default.
- You can change the ephemeral IP address given during deployment to a static IP address, after you complete the deployment.
- **Interface Order**—First network interface is mapped to fxp0, second network interface is mapped to ge-0/0/0, 3rd network interface is mapped to ge-0/0/1.
- **Number of vSRX Interfaces**
  - The maximum number of virtual interfaces allowed per vSRX Virtual Firewall instance is 8.
  - To create a vSRX Virtual Firewall instance, you have to specify the machine type. The machine type specifies a particular collection of virtualized hardware resources available to a VM instance, including the memory size, virtual CPU count, and maximum disk capacity.
  - **Default VPC Network**—There is default network in a GCP project, you can delete the default network if unused. By default, 5 networks in a project. You can request additional networks for your project.
  - **Firewall Rules**—You must create a GCP firewall rules to allows access for management connection.

Before you begin, ensure to have the following ready:

- Google Cloud Platform Account Planning
- SSH Key Pair
- Virtual Private Cloud (VPC) Network Planning

## Step 1: Google Cloud Platform Account Planning

Before you begin deploying vSRX Virtual Firewall VM, review the licensing information and collect the information you'll need for the configuration process.

1. Understand your vSRX Virtual Firewall license requirements.
2. Determine private IP address for your management and other interfaces.
3. Get required permissions for the GCP account.
  - GCP user account with a linked e-mail address
  - Identity and access management (IAM) roles as Compute Viewer, Storage Object Viewer, and Monitoring Metric Writer.

**Accounts and Permissions**—Ensure you have proper accounts and permissions before your deploy vSRX Virtual Firewall 3.0 on a Google Computer Engine instance. Sample account roles and IAM permissions are shown in [Figure 131 on page 563](#)

**Figure 131: Sample Account Roles and IAM Permissions**

Filter table

Type	Member ↑	Name	Role	Inheritance
	335156400566-compute@developer.gserviceaccount.com	Compute Engine default service account	Editor	
	335156400566@cloudservices.gserviceaccount.com	Google APIs Service Agent	Editor	
	user@juniper.net	user	Editor	
	user@juniper.net	user	Editor	

## Step 2: Define Network Attributes and Generate SSH Key Pair for Authentication

The procedure below provides you steps to define network attributes and generate your own SSH Key pairs to allow your first time login:

1. After choosing the machine type, you must define networking attributes in the advanced options for the VM.

Click the **VM instances** tab on the home page and then click the **Networking** tab as shown in [Figure 132 on page 563](#). Update the networking attributes and add the required interfaces.

**Figure 132: Define Network Attributes**

Management   Disks   **Networking**   SSH Keys

---

**Network tags** (Optional)

**Network interfaces**

default default (10.142.0.0/20)

+ Add network interface

You can add up to 8 interfaces for each vSRX Virtual Firewall instance.

**NOTE:** You cannot choose virtual interface type. GCP supports only the VirtIO interface type. SR-IOV is not supported in GCP.

2. vSRX Virtual Firewall manages authentication for first login only through RSA SSH key authentication. Password is not allowed, so you cannot log into vSRX Virtual Firewall through console on GCP web. Root login without password is not allowed. So you must generate your own SSH Key before you deploy a vSRX Virtual Firewall instance in Google Compute Engine.

Generate the public key and the private key. Create an SSH key pair and store the SSH Key in the default location for your operation system.

- If you are using Linux or MacOS: Use ssh-keygen to create the key pair in your .ssh directory. Run the `ssh-keygen -t rsa -f ~/.ssh/gcp-user-1 -C gcp-user` command. Here `gcp-user-1` is name of key file and `gcp-user` is username.

**NOTE:** It is mandatory to use “gcp-user” as username when you login to the vSRX Virtual Firewall for the first time vSRX Virtual Firewall.

- If you are using Windows: Use PuTTYgen to create the key pair.
3. Copy your public key in a text editor. You need to paste it later while deploying vSRX Virtual Firewall in the GCP Marketplace.
  4. Block project-wide SSH keys and specify an SSH key for each vSRX Virtual Firewall instance. Click the **SSH Keys** tab on the **VM instances** page as shown in [Figure 133 on page 565](#).

**NOTE:** The SSH key is used by the public key authentication for the first login. As a security measurement, you must block project-wide SSH keys and specify an SSH key for each vSRX Virtual Firewall instance.

Figure 133: Block Project-Wide SSH Keys

5. Save your private key in .ppk format. You need this key later to authenticate the vSRX Virtual Firewall instance.

### Step 3: Plan Google Virtual Private Cloud (VPC) Network

Prepare the virtual private cloud (VPC) networks in Google Cloud Platform. You must create virtual private networks, rules, and subnetworks and configure interfaces before you start deploying the vSRX Virtual Firewall on GCP which involves:

1. Log in to the Google Cloud console.
2. **VPC Networks**—You must create a custom network specifically for each vSRX Virtual Firewall network interface.  
In the left navigation area, click **VPC network** under **NETWORKING**.
3. On the top pane, click **CREATE VPC NETWORK**.
4. Enter a name for the network.
5. Create a subnetwork with the following details and click **Create**.
  - **Name**—Name of the subnetwork.
  - **IP Address**—Assign an IP address range for creating interface subnetworks. This range is used for your internal network, so ensure that the address range does not overlap with other subnets.
  - **Region**—Select the region where you want to launch your vSRX Virtual Firewall VM.
  - **Private Google Access**—Retain the default value **Off**.

- **Flow logs**—Retain the default value **Off**.

## Deploy vSRX Virtual Firewall in Google Cloud Platform

### IN THIS SECTION

- [Deploy the vSRX Virtual Firewall Firewall from Marketplace Launcher | 566](#)
- [Deploy the vSRX Virtual Firewall Instance from GCP Portal Using Custom Private Image | 574](#)
- [Deploy the vSRX Virtual Firewall Firewall Using Cloud-init | 580](#)

The following procedures describe how to deploy vSRX Virtual Firewall in the Google Virtual Private Cloud (VPC):

- Deploy the vSRX Virtual Firewall Firewall from Google Cloud Platform Marketplace.
- Use custom private image to deploy the vSRX Virtual Firewall Firewall from the GCP portal.
- Use cloud-init to deploy the vSRX Virtual Firewall Firewall through gcloud using CLI.

### Deploy the vSRX Virtual Firewall Firewall from Marketplace Launcher

You can use the Google Cloud Platform Marketplace to deploy your vSRX3.0 with licenses as a virtual machine (VM) running on a Google Compute Engine instance.

Before you deploy the vSRX Virtual Firewall, you must create or choose a project in your organization and create any networks and subnets that will connect to the firewall. You cannot attach multiple network interfaces to the same VPC network. Every interface you create must have a dedicated network with at least one subnet.

This topic provides your steps to deploy a vSRX Virtual Firewall Firewall from the Google Cloud Platform Marketplace Launcher.

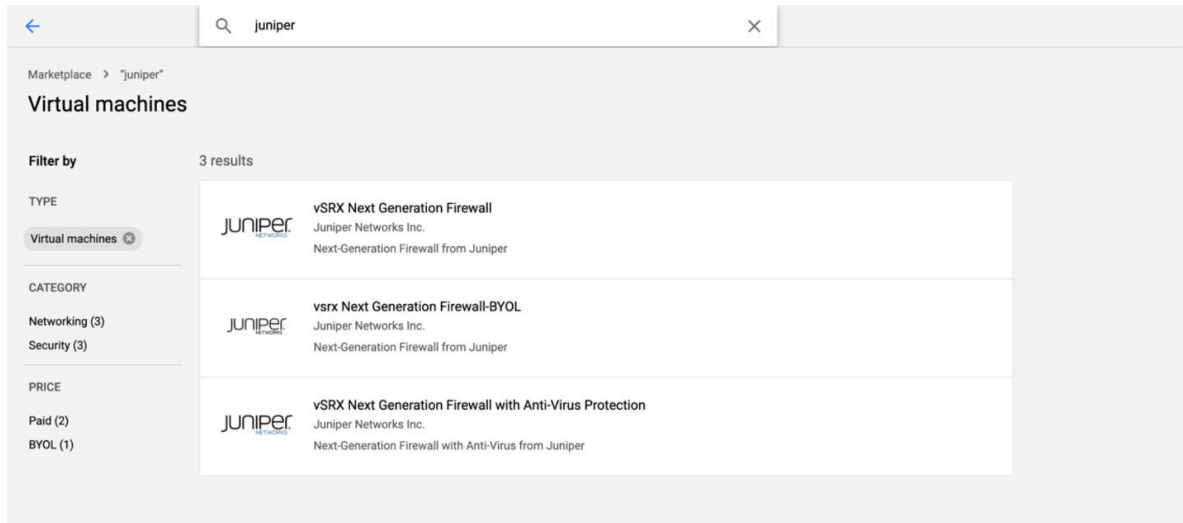
1. Log in to the Google Cloud Platform console.
2. In the left navigation area, select **Marketplace**.
3. Locate the vSRX Virtual Firewall listing in the Marketplace.

In the Search box, type 'Juniper' or 'vSRX Virtual Firewall' and click one of the following options based on your licensing requirements as shown in [Figure 134 on page 567](#).

The images are available from cloud:

- vSRX Virtual Firewall Next Generation Firewall
- vSRX Virtual Firewall Next Generation Firewall-BYOL
- vSRX Virtual Firewall Next Generation Firewall with Anti-Virus Protection

**Figure 134: Locate vSRX Virtual Firewall Listing in the GCP Marketplace**



4. Click **Launch** on Compute Engine. The deployment page appears as shown in [Figure 135 on page 568](#).



Figure 135: Launch vSRX Virtual Firewall Instance in GCP from Marketplace

**vSRX Next Generation Firewall**  
Juniper Networks Inc.  
TRIAL ACTIVE | Estimated costs: \$450.96/month  
Next-Generation Firewall from Juniper  
LAUNCH 4 PAST DEPLOYMENTS

**Runs on**  
Google Compute Engine

**Type**  
Virtual machines  
Single VM

**Last updated**  
3/19/20, 2:45 AM

**Category**  
Networking  
Security

**Version**  
1.0

**Operating system**  
Junos 19.3R2

**Overview**  
Juniper Networks vSRX empowers cloud security practitioners to secure their cloud architectures by providing consistent security policies as they develop apps and migrate workloads to GCP. Delivered and deployed through the GCP cloud, the vSRX Next Generation Firewall brings advanced security services, app visibility and secure connectivity between GCP or other datacenter locations. With cloud-grade routing capabilities, the high performing vSRX helps you to stay ahead of threats and protect your workloads. It offers enhanced connectivity using IPsec and full mesh VPN termination services—all in one, easy to use, cloud-ready package. Easily integrate the same intuitive management across your entire network with Junos OS, simplifying operations and maintaining control. Seamlessly establish secure connectivity from on-premises datacenters, campuses, and branches to the GCP cloud. The vSRX is an innovative and comprehensive security solution that delivers high firewall throughput at a low TCO to meet your goals of improving agility, scalability and reduced time to deployment. The versatile and powerful set of advanced security services, including intrusion detection and prevention (IPS), Anti-Virus and application visibility and control through AppSecure along with rich routing capabilities delivers a compelling solution for your secure network architecture. Highlights

- Core firewall and network functionality that include VPN, NAT, CoS and rich routing capabilities.
- High Performance Next Generation Firewall services that include advanced L4-L7 security services such as AppSecure features of AppID, AppFW, AppQoS, and AppTrack and IPS
- Virus protection, the UTM offers optional cloud-based antivirus capabilities that detect and block spyware, adware, viruses, keyloggers, and other malware over POP3, HTTP, SMTP and FTP protocols.

## 5. Name the instance and choose resources.

Provide the details for the vSRX Virtual Firewall VM:

- **Deployment Name**—Enter a unique name for your vSRX Virtual Firewall VM.
- **Machine type**—Select a machine type based on the system requirements for your license.
- **SSH key**—Paste your public SSH key that you created earlier.
  - Paste the key after the text `gcp-user`:

**NOTE:** It is mandatory to use “gcp-user” as username when you login to the vSRX Virtual Firewall for the first time vSRX Virtual Firewall.

- Select the Block project-wide SSH keys option.
- **Network interfaces**—Select the VPC network and the subnets. Note that you can add only those subnets that you’ve created for the selected zone for this vSRX Virtual Firewall VM.

- **IP Forwarding**—Retain the default value On. This is a mandatory requirement for the vSRX Virtual Firewall VM.
- **Enable External IP**—Select the ephemeral option. This setting allows the GCP to provide an ephemeral IP address to act as the external IP address.
- **Allow HTTP traffic from the Internet**—Retain the default value as selected. We recommend not providing HTTP access unless absolutely necessary.
- **Allow TCP port 22 traffic from the Internet**—Retain the default value as selected. For security reasons, we recommend that you limit the SSH access only to the specific IP address to access the vSRX Virtual Firewall

Name the instance and choose resources as shown in [Figure 136 on page 570](#).

Figure 136: Name vSRX Virtual Firewall Instance and Choose Resources in GCP Marketplace

← New vSRX Next Generation Firewall deployment

**Deployment name**  
vsrx-next-generation-firewall-payg-5

**Zone** ⓘ  
us-east1-c

**Machine type** ⓘ  
2 vCPUs 7.5 GB memory [Customize](#)

**SSH key** ⓘ  
Your public SSH key to access the vSRX instance  
gcp-user:ssh-rsa your-public-ssh-key

Block project-wide SSH keys ⓘ

**Boot Disk**  
**Boot disk type** ⓘ  
Standard Persistent Disk

**Boot disk size in GB** ⓘ  
19

**Networking**  
**Network interfaces**  
! user-vpc

[+ Add network interface](#)

**Firewall** ⓘ  
Add tags and firewall rules to allow specific network traffic from the Internet

Creating certain firewall rules may expose your instance to the Internet. Please check if the rules you are creating are aligned with your security preferences. [Learn more](#)


Allow HTTP traffic from the Internet  
**Source IP ranges for HTTP traffic** ⓘ  
0.0.0.0/0, 192.169.0.2/24

Allow TCP port 22 traffic from the Internet  
**Source IP ranges for TCP port 22 traffic** ⓘ  
0.0.0.0, 192.169.0.2/24

- a. Choose a **Deployment Name**. The name must be unique and cannot conflict with any other deployment in the project.
- b. Select a zone.
- c. Select a machine type.


- d. Set the SSH Key as shown in [Figure 137 on page 571](#).

Figure 137: SSH Key

**SSH key** 

Your public SSH key to access the vSRX instance

`gcp-user: ssh-rsa AAAAB3NzaC1yc2EAAAADAQABAAQDeR2jhMLzSfgee/5c`

**Block project-wide SSH keys** 

- e. Configure the network and subnet.
- f. Leave **IP forwarding** 'on' (mandatory for vSRX Virtual Firewall deployments) as shown in [Figure 138 on page 572](#).

Figure 138: IP Forwarding Configuration

The screenshot shows the Google Cloud Platform console for configuring a new vsrx Next Generation Firewall-BYOL deployment. The configuration is as follows:

- Deployment name:** vsrx-next-generation-firewall-byol-7
- Zone:** us-east1-b
- Machine type:** 4 vCPUs, 15 GB memory
- Boot Disk:** Standard Persistent Disk, 30 GB
- Networking:**
  - Network interfaces: user-pub-vcpc user-pub-sub1 (10.10.1.0/24), user-vsr3-vcpc user-mgmt (10.1.0.0/24), user-private-vcpc user-pri-sub1 (10.11.0.0/24)
  - + Add network interface
- Firewall:**
  - Warning: Creating certain firewall rules may expose your instance to the Internet. Please check if the rules you are creating are aligned with your security preferences.
  - Allow HTTP traffic from the Internet: Source IP ranges for HTTP traffic: 0.0.0.0/0, 192.169.0.2/24
  - Allow TCP port 22 traffic from the Internet: Source IP ranges for TCP port 22 traffic: 0.0.0.0/0, 192.169.0.2/24
  - IP forwarding: On

On the right side, the **JUNIPER NETWORKS vsrx Next Generation Firewall-BYOL overview** is displayed, including pricing (\$98.53 per month estimated) and software details (Junos 19.3R1).

6. Accept GCP Marketplace **Terms of Service**.

7. Click **Deploy**.

The system shows the progress of your vSRX Virtual Firewall deployment. It displays a message indicating the successful completion of the deployment and sends you an e-mail notification for the same.

8. Click your VM to view the details. You can view your VM details by navigating to the Compute Engine under **COMPUTE** in the left navigation area.

Make note of the external IP address, shown under Network interfaces. You'll need this address later to log on to your vSRX Virtual Firewall instance using the CLI.

9. Logging in to a vSRX Virtual Firewall Instance.

In GCP deployments, vSRX Virtual Firewall instances provide the following capabilities by default to enhance security:

- Allows you to login only through SSH.
- cloud-init is used to setup SSH key login.
- SSH password login is disabled for root account.

**NOTE:** Root login using SSH password is disabled by default.

Use an SSH client to log in to a vSRX Virtual Firewall instance for the first time. To log in, specify the location where you saved the SSH key pair file for the user account, and the IP address assigned to the vSRX Virtual Firewall management interface (fxp0).

**NOTE:** Root login using a Junos OS password is disabled by default. You can configure other users after the initial Junos OS setup phase.

If you do not have the key pair filename and the IP address, use these steps to view the key pair name and IP for a vSRX Virtual Firewall instance:

- a. In the GCP portal, select **Instances**.
- b. Select the vSRX Virtual Firewall instance, and select **eth0** in the Description tab to view the IP address for the fxp0 management interface.
- c. Click **Connect** above the list of instances to view the SSH key pair filename.

To configure the basic settings for the vSRX Virtual Firewall instance, see *Configure vSRX Using the CLI*.

**NOTE:** gcloud connect to vSRX Virtual Firewall is not supported. Always use ssh with user provided key to connect to vSRX Virtual Firewall after instance is up.

## Deploy the vSRX Virtual Firewall Instance from GCP Portal Using Custom Private Image

### IN THIS SECTION

- [Upload vSRX Virtual Firewall Image to Google Cloud Storage | 574](#)
- [Create vSRX Virtual Firewall Image | 576](#)
- [Deploy the vSRX Virtual Firewall Firewall from GCP Portal | 578](#)

You can also use your custom private image to deploy the vSRX Virtual Firewall instead of deploying an image from GCP marketplace. Firstly you need upload the private image to Google Cloud storage, then create compute image in GCP, and then deploy vSRX Virtual Firewall on Google Compute Engine.

Watch the video [Deploying vSRX Virtual Firewalls on Google Cloud Platform](#) to understand how you can deploy vSRX Virtual Firewall instances from GCP.

### Upload vSRX Virtual Firewall Image to Google Cloud Storage

To upload vSRX Virtual Firewall image to Google Cloud Storage:

#### 1. Prepare the private vSRX Virtual Firewall image file.

A custom image is a boot disk image that is private to you. To import a disk image to Google Compute Engine, the image file must meet the following requirements.

- Disk image filename must be **disk.raw**.
- RAW image file must have a size in an increment of 1 GB. For example, the file must be either 10 GB or 11 GB but not 10.5 GB.
- Compressed file must be a .tar.gz file that uses gzip compression and the GNU tar format.

To use .qcow2 vSRX Virtual Firewall image to generate .tar.gz file follow below steps to process the upload.

#### a. Convert .qcow2 to "disk.raw" (disk.raw is the dedicate name for google cloud deployment).

```
qemu-img convert -f qcow2 -o raw junos-vsrx3-x86-64-19.2I-20190115_dev_common.0.1057.qcow2 disk.raw
```

#### b. Compress to .tgz file.

```
tar -czf vsrx-0115.tar.gz disk.raw
```

#### 2. Upload image to Google Cloud Storage. You can upload your custom private image in two ways:

- Upload image through SDK shell

- Upload image from Google Cloud Platform portal

Upload image through SDK shell:

Install Google Cloud SDK on Ubuntu.

You must install Google Cloud SDK on your operation system. below is the sample to install it on Ubuntu.

For more information on Google Cloud SDK installation on Ubuntu, see <https://cloud.google.com/sdk/docs/quickstart-debian-ubuntu> and for Gcloud command-line tool overview, see <https://cloud.google.com/sdk/gcloud/>.

To upload image through SDK shell:

1. Create google cloud storage.

```
gs://vsrx-image
```

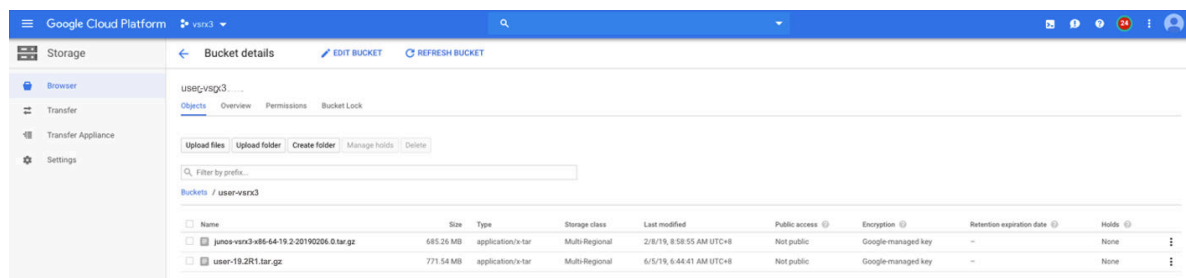
2. Copy disk.raw to cloud storage.

```
gsutil cp vsrx-0115.tar.gz gs://vsrx-image
```

To upload image from Google Cloud Platform portal.

1. Click **Storage->Create Bucket->Upload files** as shown in [Figure 139 on page 575](#).

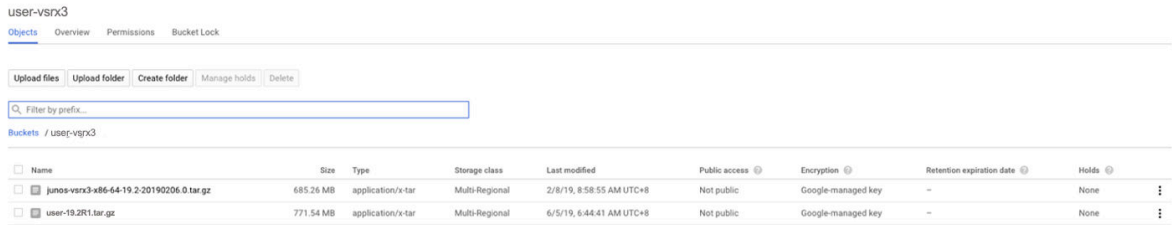
**Figure 139: vSRX Virtual Firewall Image Upload from GCP Portal**



2. Check the private image is available in Google Cloud Storage by selecting **Storage -> Bucket detail** in Google Cloud Platform web as shown in [Figure 140 on page 576](#).



Figure 140: View Private Images in GCP Portal



## Create vSRX Virtual Firewall Image

After you upload the vSRX Virtual Firewall image file to GCP storage you need to create GCP compute image for vSRX Virtual Firewall deployment.

### 1. Create image in cloud.

A sample to create vSRX Virtual Firewall image using the package ready in GCP project storage is shown below. The option of 'multi\_ip\_subnet' is mandatory.

```
gcloud compute images create vsrx-0115 '--guest-os-features=multi_ip_subnet' --source-uri=gs://vsrx-image/vsrx-0115.tar.gz
```

### 2. Check the private image is available in Google Cloud Compute Engine.

```
root@cnrd-ubuntu173:~# gcloud compute images list | grep vsrx3-194* vsrx-0115. vsrx3-218606 READY
```

## Using Google Console

You can rename the image file using the Google console as well.

1. Log in to your Google account and open the **Google Cloud Platform** home page.
2. Click the **images** option on the **Google Cloud Platform** page. The **Create an image** page opens as shown in [Figure 141 on page 577](#)

Figure 141: Google Cloud Platform Image Creation Page

The screenshot displays the Google Cloud Platform interface for creating a new image. The left sidebar shows the 'Compute Engine' section with 'Images' selected. The main panel, titled 'Create an image', includes the following fields and options:

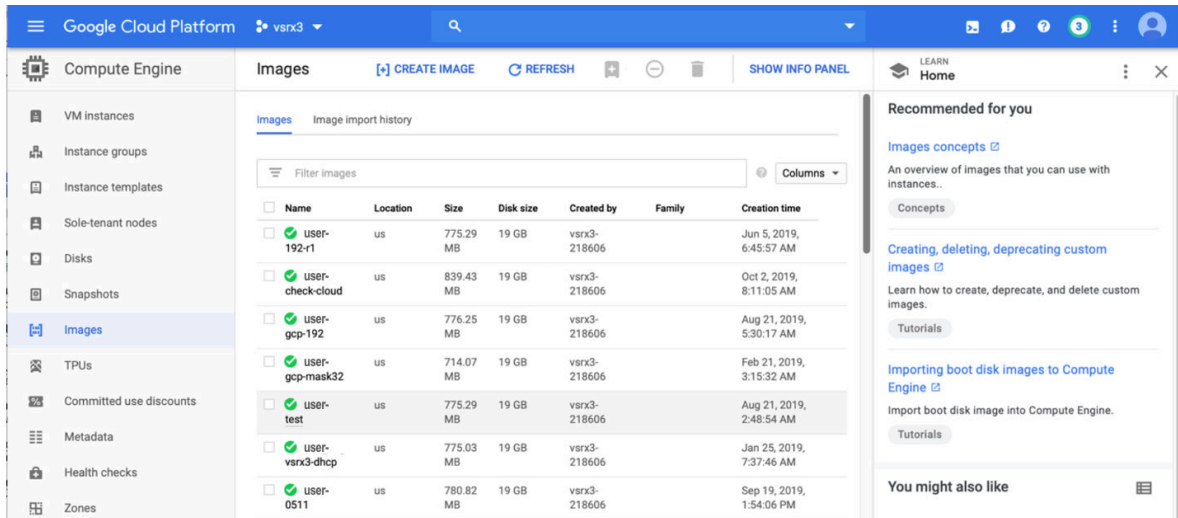
- Name:** A text input field containing 'image-6'.
- Family (Optional):** An empty text input field.
- Description (Optional):** An empty text input field with a clear icon.
- Encryption:** A dropdown menu set to 'Automatic (recommended)'.
- Source:** A list of options: 'Disk', 'Image', and 'Cloud Storage file'.
- Buttons:** 'Create' and 'Cancel' buttons.
- Footer:** A link for 'Equivalent REST or command line'.

3. Fill in the required details in the **Create an image** page and click **Create**.

**NOTE:** It is mandatory to use “gcp-user” as username when you login to the vSRX Virtual Firewall for the first time vSRX Virtual Firewall.

4. Check the private image that available in Google Cloud Compute Engine. On Google Cloud Platform web, click **Compute Engine**->**Images** as shown in [Figure 142 on page 578](#).

Figure 142: Check Private Image in Google Cloud Compute Engine



## Deploy the vSRX Virtual Firewall Firewall from GCP Portal

You can follow below steps to deploy a vSRX Virtual Firewall instance:

1. Login Google Cloud Platform portal, go to **Compute Engine -> VM instances** and click **CREATE INSTANCE**.
2. Configure a vSRX Virtual Firewall instance.
  - **Name**—Specify a unique name to the instance.
  - **Region**—Select proper region you want to deploy the vSRX Virtual Firewall on, you must already create subnet in same region in proper VPC networks.
  - **Machine configuration** —Choose correct machine type.
  - **Container** —Uncheck
  - **Boot Disk**—Choose the private image in **Custom Images** tab as shown in [Figure 143 on page 579](#). You must already upload the private image to Google Cloud Storage.

Figure 143: Boot Disk from Custom Images

## Boot disk

Select an image or snapshot to create a boot disk; or attach an existing disk

OS images   Application images   **Custom images**   Snapshots   Existing disks

Show images from

vsr3

- user-192-r1**  
Created from vsrx3 on Jun 5, 2019, 6:45:57 AM
- user-gcp-mask32**  
Created from vsrx3 on Feb 21, 2019, 3:15:32 AM
- user-vsr3-dhcp**  
Created from vsrx3 on Jan 25, 2019, 7:37:46 AM

- **Identity and API access**—Set default
- **Firewall / Management** —Set default
- **Firewall / Security**—Paste your SSH Key pair here. Details please reference “Prepare to setup vSRX Virtual Firewall on GCP – SSH Key”.
- **Firewall / Disks**—Set default
- **Firewall / Networking:**

**Table 92: Firewall Networking**

Firewall / Networking	Details
Hostname	Optional, you can specify tags for the instance used for route configuration.
Network Interfaces	Default
	You can set interfaces to existing VPC networks and subnet in same region. Interface number, Interface order and manage interface setting.

3. Click **Create**

#### 4. Logging in to a vSRX Virtual Firewall Instance.

In GCP deployments, vSRX Virtual Firewall instances provide the following capabilities by default to enhance security:

- Allows you to login only through SSH.
- SSH password login is disabled for root account.

**NOTE:** Root login using a Junos OS password or SSH password is disabled by default. You can configure other users after the initial Junos OS setup phase.

Use an SSH client to log in to a vSRX Virtual Firewall instance for the first time. To log in, specify the location where you saved the SSH key pair file for the user account, and the IP address assigned to the vSRX Virtual Firewall management interface (fxp0).

**NOTE:** It is mandatory to use “gcp-user” as username when you login to the vSRX Virtual Firewall for the first time vSRX Virtual Firewall.

If you do not have the key pair filename and the IP address, use these steps to view the key pair name and IP for a vSRX Virtual Firewall instance:

- a. In the GCP portal, select **Instances**.
- b. Select the vSRX Virtual Firewall instance, and select **eth0** in the Description tab to view the IP address for the fxp0 management interface.
- c. Click **Connect** above the list of instances to view the SSH key pair filename.

To configure the basic settings for the vSRX Virtual Firewall instance, see *Configure vSRX Using the CLI*.

**NOTE:** gcloud connect to vSRX Virtual Firewall is not supported. Always use ssh with user provided key to connect to vSRX Virtual Firewall after instance is up.

### Deploy the vSRX Virtual Firewall Firewall Using Cloud-init

vSRX Virtual Firewall supports cloud-init. Cloud-init is an open-source multi-distribution package that handles early initialization of a cloud instance. It allows user to customize VM instance with attributes like hostname and default IP on the first boot. Cloud-init is particularly useful when user wants to deploy large number of VM instances in the data center using automation tools.

Some of the initial provisioning parameters for first boot are:

- Hostname
- Root password
- SSH public key

**NOTE:** for the ssh key file, it needs to be in the format "<username>:<key value>" as required by google cloud. Something like this:

- Management interface (fxp0) IP
- Default gateway IP

You can deploy vSRX Virtual Firewall Firewall using cloud-init in two ways:

- From Google SDK
- To deploy vSRX Virtual Firewall with cloud-init from Google portal, see "[Deploy the vSRX Virtual Firewall Firewall from GCP Portal](#)" on page 578. To add user-data to have cloud init enabled specify the metadata.

GCE supports cloud-init type instance configuration. To launch instance with user data, use the command below as an example.

**Figure 144: Sample Cloud-Init Configuration**

```
gcloud compute instances create vsrx-cloudinit-001 --image vsrx-0115 \
--zone=us-west1-b \
--network-interface address=,network=vpc-1-mgt,subnet=subnet-1-uswest1-5 \
--network-interface address=,network=vpc-untrust-global,subnet=subnet-6-
uswest1-16,private-network-ip=10.16.16.113 \
--network-interface no-address,network=vpc-trust-regional,subnet=subnet-7-
uswest1-26,private-network-ip=10.26.26.113 \
--machine-type=n1-standard-4 --can-ip-forward \
--metadata-from-file user-data=junos.conf,ssh-keys=gcp-user.pub
```

Please note the following points:

- junos.conf is configuration file with '#junos-config' in content
- gcp-user.pub is ssh public key
- vSRX Virtual Firewall 3.0 supports RSA key pair only
- For the SSH key file, it needs to be in the format <username>:<key value> as required by Google cloud. Refer the sample SSH key file below.

```

root@cnrd-kvmsrv37:~# cat gcp-user.pub
ssh-rsa AAAAB3NzaC1yc2EAAAADAQABAAQDeR2jhMLzSfgee/5cnduTa+13yVLKbTa/
0FnZSHQsZoA5LKHIxs/TbyooZTX5PnfNr6hx2Iyxjaodu01kT0UJ87wps8n9BH74DP6x0YK070aZZ15T/
5Iso9fXRCz19+go9vKzNKhqXmqKUc3Fl6hTX2QzQbtrwN2twLzCzx+0SliCoobJr+/
8wPcvI6fUbl6FRTgE1zC1HB1DKspK7x47YDYPJ1UcyMhRtGvxd319jrx5i96mZq850+
dCfZkHSipT09hFRtk8C4Ms0aKsw3RWUCY5LCPekrutrLLfhMKh88onv4ud7gX0klSwgVVod49aY2FfiaACMAVoamfYXwe
P
gcp-user

```

```
ssh -i <private-key> gcp-user@<vSRX management public ip>
```

- In junos.conf, please remove the “gcp-default” block in your user data. They will shadow the one created by vSRX Virtual Firewall init script. Refer the sample junos config

```

#junos-config
security {
  policies {
    default-policy {
      permit-all;
    }
  }
  zones {
    security-zone trust {
      interfaces {
        ge-0/0/0.0;
      }
    }
    security-zone untrust {
      interfaces {
        ge-0/0/1.0;
      }
    }
  }
}

```

```
    }
  }
}
interfaces {
  ge-0/0/0 {
    unit 0 {
      family inet {
        10.0.0.10/24;
      }
    }
  }
  ge-0/0/1 {
    unit 0 {
      family inet {
        10.0.1.10/24;
      }
    }
  }
}
}
```

**NOTE:** gcloud connect to vSRX Virtual Firewall is not supported. Always use ssh with user provided key to connect to vSRX Virtual Firewall after instance is up.

## RELATED DOCUMENTATION

| [Deploying vSRX Virtual Firewalls on Google Cloud Platform](#)

## Upgrade the Junos OS for vSRX Virtual Firewall Software Release

You can upgrade the Junos OS for vSRX Virtual Firewall software using the CLI. Upgrading or downgrading Junos OS can take several hours, depending on the size and configuration of the network. Download the desired Junos OS Release for the **vSRX.tgz** file from the [Juniper Networks website](#).

You also can upgrade using J-Web (see [J-Web](#)) or the Junos Space Network Management Platform (see [Junos Space](#)).



For the procedure on upgrading a specific Junos OS for vSRX Virtual Firewall software release, see the *Migration, Upgrade, and Downgrade Instructions* topic in the release-specific *vSRX Virtual Firewall Release Notes* available on the [vSRX TechLibrary](#) webpage.

## Secure Data with vSRX Virtual Firewall 3.0 Using GCP KMS (HSM)

### IN THIS SECTION

- [Overview | 584](#)
- [Integrate GCP KMS with vSRX Virtual Firewall 3.0 | 586](#)
- [Verify the Status of the HSM | 589](#)
- [show security hsm status | 590](#)
- [| 592](#)
- [request security hsm master-encryption-password | 592](#)

This topic describes the integration of vSRX Virtual Firewall 3.0 with GCP (Google Cloud Platform) Key management Service (KMS) for securing confidential information such as private keys that must be stored within a FIPS boundary. GCP provides support for KMS that is used by applications such as vSRX Virtual Firewall 3.0 to safeguard and to manage cryptographic keys.

### Overview

A wrapper library is available in Junos to enable VPN and other applications (such as mgd) to integrate and communicate with cloud-based KMS. This wrapper library provides interface to Key Management Service (KMS) using PKCS#11 APIs. Junos applications use this wrapper library with updated support for GCP to communicate with KMS. To support PKCS#11 APIs, GCP team provides Juniper a library which acts as an intermediary between Junos applications and Cloud KMS service. This library is added as part of vSRX Virtual Firewall 3.0 Junos package. There is no action needed from you to enable the libraries.

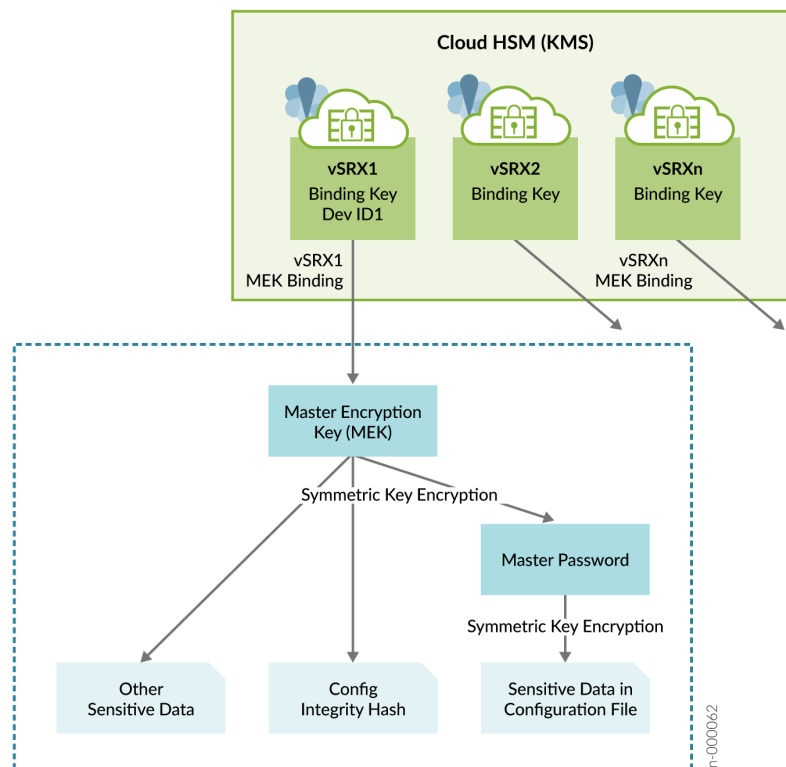
After enabling the KMS service, you need to specify the Master Encryption Key (MEK) using the `request security hsm master-encryption-password set plain-text-password` command. vSRX Virtual Firewall 3.0 then creates RSA 2048 key pair Master binding Key (MBK) in KMS and encrypts MEK using MBK in KMS. MEK is then used as a key for encrypting data at rest such as hash of configuration, private key pair files and master-password file.

vSRX Virtual Firewall with GCP KMS has the following limitations:

- vSRX Virtual Firewall uses management interface to access KMS service. If management interface is not enabled or configured, KMS service cannot be used from vSRX Virtual Firewall.
- SSL Proxy, Sky-ATP, IDP Signature download or any other module using certificate-based connections will not work when HSM is enabled.
- RSA Key Pair with a Key ID can be generated only once. It cannot be used for another Key Pair to generate or create request, for a deleted Key ID, or for another new Key request.

Figure 1 illustrates the inventory of keys in vSRX Virtual Firewall 3.0.

Figure 145: Supply of Keys in vSRX Virtual Firewall 3.0



Support for generating Public Key Infrastructure (PKI) key-pairs in GCP cloud KMS is enabled and any request such as RSA SIGN, which needs private key of the generated key-pair is sent to GCP cloud KMS. Specifically, the following operations have been offloaded to the KMS:

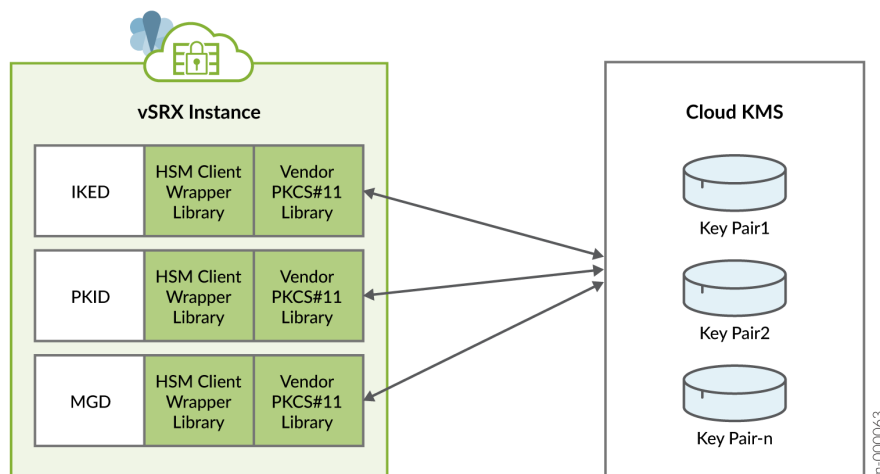
- Private key signing during Certificate Signing Request (CSR) creation in PKI Daemon (PKID) running on the device.
- Private key signing during verification of the certificate received from the CA server in PKID.

- Private key signing during IKE negotiations at Key Management Daemon (KMD) which is the IKE Daemon running on the device.

All the VPN applications (PKID and KMD) will use wrapper library to communicate with the KMS service to create, manage and execute crypto operations on the RSA keys.

Figure 2 illustrates how VPN applications accessing KMS service.

**Figure 146: VPN Applications Accessing KMS Service**



You can secure data at rest and achieve configuration integrity with vSRX Virtual Firewall 3.0 using GCP KMS. Perform the steps given in this topic to setup GCP Cloud KMS service and Key Ring for vSRX Virtual Firewall 3.0.

Key Ring is a component in KMS service where keys created by Junos applications are going to reside. A key ring organizes keys in a specific Google Cloud location and allows you to manage access control on groups of keys. A key ring's name does not need to be unique across a Google Cloud project, but must be unique within a given location. After creation, a key ring cannot be deleted. Key rings do not incur storage costs.

### Integrate GCP KMS with vSRX Virtual Firewall 3.0

To enable and setup vSRX Virtual Firewall 3.0 to access KMS on GCP.

1. Launch vSRX Virtual Firewall 3.0 instance in GCP. See [Deploying vSRX Virtual Firewalls on Google Cloud Platform](#) and [Deploy vSRX in Google Cloud Platform](#).
2. Setup GCP KMS for vSRX Virtual Firewall 3.0.

Before you can enable vSRX Virtual Firewall 3.0 to communicate with the KMS service, you need to ensure vSRX Virtual Firewall 3.0 instance is authenticated and authorized to access GCP Cloud KMS service. To setup GCP environment or account do the following:

**a.** Create a service account.

A service account is a special type of Google account intended to represent a non-human user such as virtual machines (VMs), that needs to authenticate and be authorized to access data in Google APIs.

vSRX Virtual Firewall 3.0 uses the PKCS#11 library provided by GCP to access Cloud KMS service. The library uses service accounts to authenticate using service account credentials.

- i.** To create a new service account to use with vSRX Virtual Firewall 3.0 to access Cloud KMS, see

[Getting Started with Authentication](#). If you already have a service account then, see [Authenticating as a service account](#).

- ii.** Create IAM role for the service account to enable access for vSRX Virtual Firewall 3.0 instance.

Once you have service account setup, grant the account a role or roles with the following IAM permissions:

- `cloudkms.cryptoKeys.list` on all configured KeyRings.
- `cloudkms.cryptoKeyVersions.list` on all CryptoKeys in each configured KeyRing.
- `cloudkms.cryptoKeyVersions.viewPublicKey` for all asymmetric keys contained within all configured KeyRings.
- `cloudkms.cryptoKeyVersions.use to Decrypt` or `cloudkms.cryptoKeyVersions.use to sign` for any keys to be used for decryption or signing.
- `cloudkms.cryptoKeys.create` if you intend to create keys.
- `cloudkms.cryptoKeyVersions.destroy` if you intend to destroy keys.

You can also use pre-defined groups of IAM roles as listed below to grant service account the needed permissions. For more information about roles associated for each of the above groups, see [Permissions and roles](#)

- iii.** Attach IAM role to vSRX Virtual Firewall 3.0 instance either from GUI or using GCP CLI.

After you have service account created and granted needed IAM roles as mentioned above, you can either create a new vSRX Virtual Firewall 3.0 instance using this service account or set an existing vSRX Virtual Firewall 3.0 instance to use the service account.

For more information, see [Creating and enabling service accounts for instances](#).

iv. Create Key Ring

After granting required access for vSRX Virtual Firewall 3.0 instance to communicate with KMS, you need to create Key Ring, which is a component in KMS service where keys created by vSRX Virtual Firewall 3.0 will reside.

Key Ring can be created using gcloud or from console. For more information, see [Create a key ring](#)

Additionally, GCP KMS does not allow creation of a key with an ID which was already used and created earlier. GCP KMS also does not allow deletion of existing key and creating another key with same name.

**NOTE:** Key ring can be created in one specific region, dual-regional or multi-regional locations. Location refers to the datacenter in which your keys are going to be saved. If you use one specific region key is located in that location only. In case of dual regions, keys are replicated to other regions and same implies for multi-regional locations. For more information, see [Cloud KMS locations](#).

After you create Key Ring, please note down the resource ID for the key ring as it is needed for input into vSRX Virtual Firewall 3.0 using CLI. GCP PKCS#11 KMS library on vSRX Virtual Firewall 3.0 will use this resource ID to communicate with KMS. Name of Key created in Key ring can contain letters, numbers, underscores (\_), and hyphens (-).

3. Provide GCP Key Ring resource information using the request `security hsm set gcp project <name_of_project> location <location_of_key_ring> key-ring <name_of_key_ring>` command. For more information, see [Getting a Cloud KMS resource ID](#)
4. After enabling the KMS service, you need to specify the Master Encryption Key (MEK) using the `request security hsm master-encryption-password set plain-text-password` command on vSRX Virtual Firewall 3.0.

Once you specify the MEK, vSRX Virtual Firewall 3.0 creates the RSA 2048 key pair (MBK) in KMS and encrypts MEK using Master binding Key (MBK) in KMS. MEK is then used as a key for encrypting data at rest such as hash of configuration, private key pair files and master-password file.

5. Change the Master Encryption Password.

If you want to change the master encryption password then you can run the `request security hsm master-encryption-password set plain-text-password` command from operational mode:

**NOTE:** It is recommended that no configuration changes are made while you are changing the master encryption password.

The system checks if the master encryption password is already configured. If master encryption password is configured, then you are prompted to enter the current master encryption password.

The entered master encryption password is validated against the current master encryption password to make sure these master encryption passwords match. If the validation succeeds, you will be prompted to enter the new master encryption password as plain text. You will be asked to enter the key twice to validate the password.

The system then proceeds to re-encrypt the sensitive data with the new master encryption password. You must wait for this process of re-encryption to complete before attempting to change the master encryption password again.

If the encrypted master encryption password file is lost or corrupted, the system will not be able to decrypt the sensitive data. The system can only be recovered by re-importing the sensitive data in clear text, and re-encrypting them.

6. Check HSM status using the `show security hsm status` command to check if KMS is enabled and reachable, also displays the Resource ID of Key Ring being used, Master binding Key (MBK), and Master Encryption Key (MEK) status.

## Verify the Status of the HSM

### IN THIS SECTION

- [Purpose | 589](#)
- [Action | 589](#)

### Purpose

To check connectivity with HSM.

### Action

You can use the `show security hsm status` command to verify the status of the HSM. The following information is displayed:

- If HSM is enabled and reachable or disabled

- Is Master Binding Key (RSA Key pair) created in HSM
- Is Master Encryption Key configured - master encryption password status (set or not set)
- Cloud vendor Information

## show security hsm status

### IN THIS SECTION

- [Syntax | 590](#)
- [Release Information | 590](#)
- [Description | 590](#)
- [Options | 590](#)
- [Required Privilege Level | 591](#)
- [Output Fields | 591](#)
- [Sample Output | 591](#)

### Syntax

```
show security hsm status
```

### Release Information

Command introduced in Junos OS Release 19.4R1.

### Description

Display the current status of the Hardware Security Module (HSM). You can use this `show security hsm status` command to check the status of HSM, master binding key, master encryption password, and cloud vendor details.

### Options

This command has no options.

## Required Privilege Level

security

## Output Fields

[Table 93 on page 591](#) lists the output fields for the `show security hsm status` command.

**Table 93: show security hsm status Output Fields**

Field Name	Field Description
Enabled	Specifies whether HSM is enabled or disabled.
Master Binding Key	Displays the HSM's Master Binding Key status whether it is created or not created in HSM. HSM generates cryptographic keys and encrypts them so that those can only be decrypted by the HSM. This process is known as binding. Each HSM has a master binding key, which is also known as storage root key.
Master Encryption Key	Displays Master Encryption configuration status whether it is set or not set. The encrypted data and the hash of the configuration is protected by vSRX Virtual Firewall using Microsoft Key Vault (HSM) service.
Cloud vendor Details	Displays the details specific to the cloud vendor.

## Sample Output

**show security hsm status (HSM status command output when vSRX Virtual Firewall initially boots up but GCP KMS feature is not enabled)**

```
user@host> show security hsm status
```

```
HSM Status:
  Accessible: no
  Master Binding Key: not-created
```



```
Master Encryption Key: not-configured
```

## show security hsm status (HSM status command output after successful integration with GCP KMS)

```
user@host> show security hsm status
```

```
HSM Status:  
  Accessible: yes  
  Master Binding Key: not-created  
  Master Encryption Key: not-configured  
  GCP Key Ring: projects/example-project-98765/locations/us-central1/keyRings/example-ring
```

## request security hsm master-encryption-password

### IN THIS SECTION

- [Syntax | 592](#)
- [Release Information | 593](#)
- [Description | 593](#)
- [Options | 593](#)
- [Required Privilege Level | 593](#)
- [Output Fields | 593](#)
- [Sample Output | 593](#)

### Syntax

```
request security hsm master-encryption-password set plain-text-password
```

## Release Information

Command introduced in Junos OS Release 19.4R1.

## Description

Use this command to set or replace the password (in plain text).

## Options

**plain-text-password**                      Set or replace the password (in plain text).

## Required Privilege Level

maintenance

## Output Fields

When you enter this command, you are provided feedback on the status of your request.

## Sample Output

**request security hsm master-encryption-password set plain-text-password**

```
user@host>                      request security hsm master-encryption-password set plain-text-password
```

```
Enter new master encryption password:
Repeat new master encryption password:
Binding password with HSM
Master encryption password is bound to HSM
Encoding master password ..
Successfully encoded master password
Deleting all previous local certificates, keypairs and certificate requests
```

# 9

PART

## vSRX Virtual Firewall Deployment for IBM Cloud

---

[Overview | 595](#)

[Installing and Configuring vSRX Virtual Firewall in IBM | 618](#)

[Managing vSRX Virtual Firewall in IBM Cloud | 666](#)

[Monitoring and Troubleshooting | 669](#)

---

# Overview

## IN THIS CHAPTER

- [vSRX Virtual Firewall Overview | 595](#)
- [Getting Started with Juniper vSRX Virtual Firewall on IBM Cloud | 598](#)
- [Junos OS Features Supported on vSRX Virtual Firewall | 604](#)

## vSRX Virtual Firewall Overview

### SUMMARY

In this topic you learn about vSRX Virtual Firewall architecture and its benefits.

### IN THIS SECTION

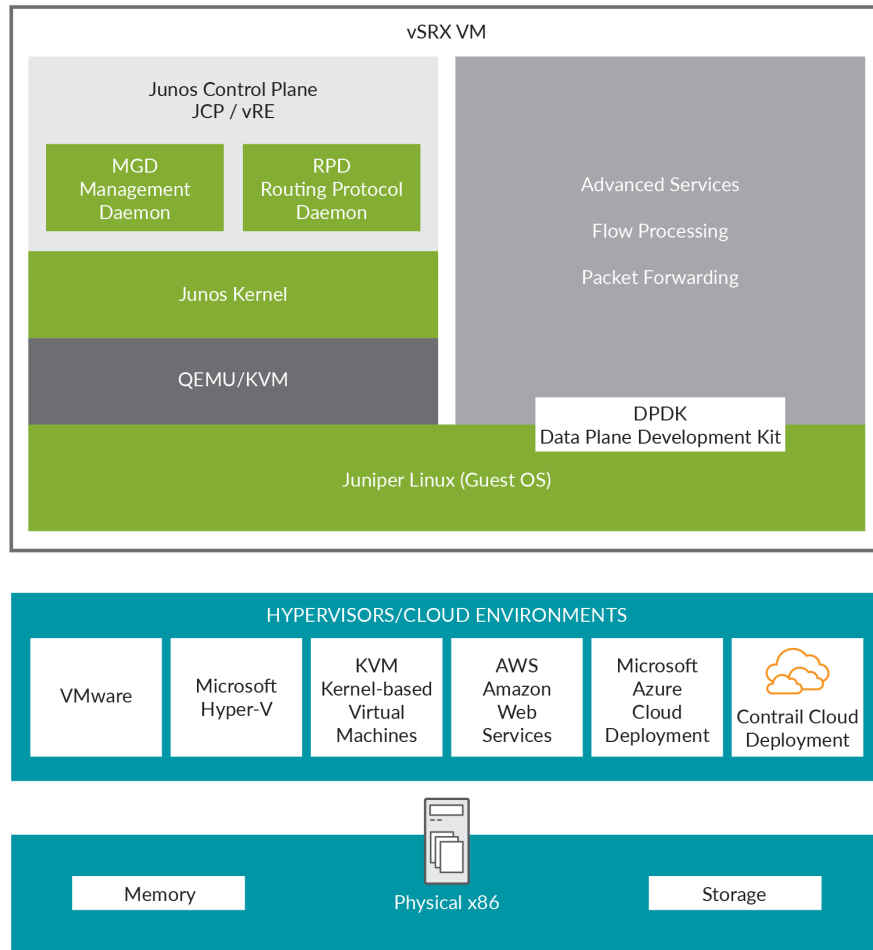
- [Benefits | 597](#)

vSRX Virtual Firewall is a virtual security appliance that provides security and networking services at the perimeter or edge in virtualized private or public *cloud* environments. vSRX Virtual Firewall runs as a virtual machine (*VM*) on a standard x86 server. vSRX Virtual Firewall is built on the Junos operating system (Junos OS) and delivers networking and security features similar to those available on the software releases for the SRX Series Firewalls.

The vSRX Virtual Firewall provides you with a complete Next-Generation Firewall (NGFW) solution, including core firewall, VPN, NAT, advanced Layer 4 through Layer 7 security services such as Application Security, intrusion detection and prevention (IPS), and Content Security features including Enhanced Web Filtering and Anti-Virus. Combined with ATP Cloud, the vSRX Virtual Firewall offers a cloud-based advanced anti-malware service with dynamic analysis to protect against sophisticated malware, and provides built-in machine learning to improve verdict efficacy and decrease time to remediation.

[Figure 147 on page 596](#) shows the high-level architecture.

Figure 147: vSRX Virtual Firewall Architecture



vSRX Virtual Firewall includes the Junos control plane (JCP) and the packet forwarding engine (PFE) components that make up the data plane. vSRX Virtual Firewall uses one virtual CPU (vCPU) for the JCP and at least one vCPU for the PFE. Starting in Junos OS Release 15.1X49-D70 and Junos OS Release 17.3R1, multi-core vSRX Virtual Firewall supports scaling vCPUs and virtual RAM (vRAM). Additional vCPUs are applied to the data plane to increase performance.

Junos OS runs as a VM on vSRX Virtual Firewall. Junos OS does not have direct access to the NIC and only has a virtual NIC access provided by the hypervisor which might be shared with other VMs running on the same host machine. This virtual access comes with certain restrictions such as a special mode called trust mode, mode access might not be feasible because of possible security issues. To enable RETH model to work in such environments, MAC rewrite behavior is modified. Instead of copying the parent virtual MAC address to the children, we keep the children's physical MAC address intact and copy the physical MAC address of the child belonging to the active; node of the cluster to the current MAC of the reth interface. This way, MAC rewrite access is not required when trust mode is disabled.

Setting the Trust mode for VFs (virtual functions), enables the host to change the MAC address of the guest during the run time. This helps vSRX Virtual Firewall interfaces to discover multiple IPv6 neighbours and perform better under scaling conditions. ND learning on vSRX Virtual Firewall interfaces is limited to only 10 IPv6 neighbours. For Linux setting for VF trust mode run the `ip link set dev enp134s0f1 vf 0 trust on` command on the host machine.

Verify the configuration:

**user@host:~# ip link**

```
enp134s0f1: <BROADCAST,MULTICAST,UP,LOWER_UP> mtu 1500 qdisc mq portid 3cfdfed48ad9 state UP mode DEFAULT group default qlen 1000
```

```
link/ether 3c:fd:fe:d4:8a:d9 brd ff:ff:ff:ff:ff:ff
```

```
vf 0 MAC 00:00:00:00:00:00, spoof checking on, link-state auto, trust on.
```

## Benefits

vSRX Virtual Firewall on standard x86 servers enables you to quickly introduce new services, deliver customized services to customers, and scale security services based on dynamic needs. vSRX Virtual Firewall is ideal for public, private, and hybrid cloud environments.

Some of the key benefits of vSRX Virtual Firewall in a virtualized private or public cloud multitenant environment include:

- *Stateful firewall* protection at the tenant edge
- Faster deployment of virtual firewalls into new sites
- Ability to run on top of various hypervisors and public cloud infrastructures
- Full routing, *VPN*, core security, and networking capabilities
- Application security features (including IPS and App-Secure)
- Content security features (including Anti Virus, Web Filtering, Anti Spam, and Content Filtering)
- Centralized management with Junos Space Security Director and local management with J-Web Interface
- Juniper Networks Juniper Advanced Threat Prevention Cloud (ATP Cloud) integration

### Release History Table

Release	Description
15.1X49-D70	Starting in Junos OS Release 15.1X49-D70 and Junos OS Release 17.3R1, multi-core vSRX Virtual Firewall supports scaling vCPUs and virtual RAM (vRAM). Additional vCPUs are applied to the data plane to increase performance.

## Getting Started with Juniper vSRX Virtual Firewall on IBM Cloud

### IN THIS SECTION

- [Overview of vSRX Virtual Firewall in IBM Cloud | 598](#)
- [Choosing a vSRX Virtual Firewall license | 600](#)
- [Ordering a vSRX Virtual Firewall | 602](#)

IBM Cloud™ Juniper vSRX Virtual Firewall allows you to route private and public network traffic selectively, through a full-featured, enterprise-level firewall that is powered by Junos OS software features, such as full routing stacks, QoS and traffic sharing, policy-based routing, and VPN.

**NOTE:** For a list of known limitations with IBM Cloud™ Juniper vSRX Virtual Firewall Gateway, see [Known limitations](#).

### Overview of vSRX Virtual Firewall in IBM Cloud

#### IN THIS SECTION

- [Benefits of vSRX Virtual Firewall in IBM Cloud | 600](#)

The vSRX Virtual Firewall provides performance, ease of configuration, and maintenance advantages with the simplicity of running on a bare metal server. The hardware is sized to handle the routing and

security load associated with multiple VLANs, and it can be ordered with redundant network links and redundant RAID arrays. All vSRX Virtual Firewall features are customer-managed.

The IBM Cloud™ Juniper vSRX Virtual Firewall is offered in two different modes: standalone mode or High Availability (HA) cluster.

For additional documentation for IBM Cloud™ Juniper vSRX Virtual Firewall, see [Supplemental Documentation](#).

The vSRX Virtual Firewall deploys to protect your environment from external and internal threats by filtering private- and public-facing traffic. Customers can manage the vSRX Virtual Firewall themselves by defining policies and rules that allow or deny (among other actions) inbound or outbound network traffic, thereby protecting their applications from internal and external approaches. Both IPv4 and IPv6 stacks are supported in a stateful manner.

Connect your on-site data center or office to the IBM Cloud using VPN tunneling by provisioning your vSRX Virtual Firewall as a network gateway device. Remote access IPsec VPN also is supported.

For a detailed configurations on VPN, see [VPN](#).

With the vSRX Virtual Firewall gateway appliance, you can provision application and database servers without public network interfaces, and still allow your servers access to the Internet using source NAT. For enhanced security, you can protect your servers behind the gateway device, using destination NAT.

You can set up dynamic routing using BGP, which allows you to announce your own public IP space to the IBM Cloud routers.

A VLAN (virtual local area network) is a mechanism that segregates a physical network into many virtual segments. For convenience, traffic from multiple selected VLANs can be delivered through a single network cable, using a process commonly called "trunking."

vSRX Virtual Firewall is managed in two different interfaces: The vSRX Virtual Firewall server(s) and the Gateway Appliance fixture. Servers in an associated VLAN can be reached from other VLANs only by going through your vSRX Virtual Firewall; it is not possible to circumvent the vSRX Virtual Firewall unless you bypass or disassociate the VLAN.

By default, a new Gateway Appliance is associated with two non-removable "transit" VLANs, one each for your public and private networks. These networks typically are used for administration, and they can be secured by vSRX Virtual Firewall commands separately. The vSRX Virtual Firewall can manage VLANs that are associated with it through the Gateway Appliance (only).

For information on how to manage VLANs from the **Gateway Appliances Details** screen, see [Manage VLANs](#).

IBM© Cloud offers several firewalls to choose from. See [Exploring firewalls](#) section that provides comparison of the supported firewall solutions to help you choose the one that is right for you.



## Benefits of vSRX Virtual Firewall in IBM Cloud

vSRX Virtual Firewall support in IBM Cloud offers you the following benefits:

- You can use an IPsec site-to-site VPN tunnel for secure communication from your enterprise data center or office to your IBM Cloud network.
- Empowers you with greater flexibility to build connectivity between multi-tiered applications running on different isolated networks.
- BGP offers more flexibility for custom private network configurations, when you're using a mix of tunnels and Direct Link solutions.
- The Gateway Appliance provides an interface (GUI and API) for selecting the VLANs you want to associate with your vSRX Virtual Firewall. Associating a VLAN with a Gateway Appliance reroutes (or "trunks") that VLAN and all of its subnets to your vSRX Virtual Firewall, gives you control over filtering, forwarding, and protection.

## Choosing a vSRX Virtual Firewall license

There are two license types available for your IBM Cloud™ Juniper vSRX Virtual Firewall:

- Standard
- Content Security Bundle (CSB)

Each license includes a different set of features and options, and the following table outlines the differences.

**NOTE:** You can specify your license type when ordering your vSRX Virtual Firewall, as well as change the license, see [Gateway Appliance Details](#).

License Type	Features
Standard	<ul style="list-style-type: none"><li>• Core security: firewall, ALG, screens, user firewall</li><li>• IPsec VPN (site-to-site VPN)</li><li>• NAT</li><li>• CoS</li><li>• Routing services: BGP, OSPF, DHCP, J-Flow, IPv4</li><li>• Foundation: Static routing, management (J-Web, CLI, and NETCONF), on-box logging, diagnostics</li></ul>

*(Continued)*

License Type	Features
Content Security Bundle (CSB)—Includes all Standard features, along with the additional features listed in the next column.	<ul style="list-style-type: none"> <li>• AppSecure</li> <li>• Application Tracking (AppTrack)</li> <li>• Application Firewall (AppFW)</li> <li>• Application Quality of Service (AppQoS)</li> <li>• Advanced policy-based routing (APBR)</li> <li>• Application Quality of Experience (AppQoE)</li> <li>• User Firewall</li> <li>• IPS</li> <li>• Content Security               <ul style="list-style-type: none"> <li>• Anti Virus</li> <li>• Anti Spam</li> <li>• Web Filtering</li> <li>• Content Filtering</li> </ul> </li> <li>• SSL Proxy               <ul style="list-style-type: none"> <li>• SSL Forward Proxy</li> <li>• SSL Reverse Proxy</li> <li>• SSL Decrypting Mirror</li> </ul> </li> </ul>

## Ordering a vSRX Virtual Firewall

You can order your IBM Cloud™ Juniper vSRX Virtual Firewall by performing the following procedure:

1. From your browser, open the Gateway Appliances page in the [IBM Cloud catalog](#) and log in to your account.

You can also get to this page by logging in to the [IBM Cloud UI console](#) and selecting **Classic Infrastructure > Network > Gateway appliance**. Alternatively, from the [IBM Cloud catalog](#), select the **Network category** then choose the **Gateway appliance** tile.

2. Choose **Juniper vSRX (up to 1 Gbps)** or **Juniper vSRX (up to 10 Gbps)** under **Gateway Vendor**.
3. Choose your license type from **License add-ons**, either Standard or CSB. See "[Choosing a vSRX Virtual Firewall license](#)" on page 600 section for information on the features offered with each license.
4. From the **Gateway appliance** section, enter your **Host name** and **Domain** name. These fields are already be populated with default information, so ensure that the values are correct.
5. Check the **High Availability** option if needed, then select a data center **Location**, and the specific **Pod** you want from the menu.

**NOTE:** Only pods that already have an associated VLAN are displayed here. If you want to provision your gateway appliance in a pod you don't see listed, first create a VLAN there.

6. From the **Configuration** section, choose your processor's RAM. You can also define an SSH key, if you want to use it to authenticate access to your new Gateway.

The appropriate processor is chosen for you based on the license version you selected in step two. However, you can choose different RAM configurations.

7. From the **Storage disks** section, choose the options that meet your storage requirements. Reserve more than the default disk setting if you plan to run network diagnostics that generate detailed logs.

RAID0 and RAID1 options are available for added protection against data loss, as are hot spares (backup components that can be placed into service immediately when a primary component fails). You can have up to four disks per vSRX Virtual Firewall. "Disk size" with a RAID configuration is the usable disk size, as RAID configurations are mirrored.

8. From the **Network interface** section, select your **Uplink port speeds**. The default selection is a single interface, but there are redundant and private only options as well. Choose the one that best fits your needs.

The Network Interface **Add Ons** section allows you to select an IPv6 address if required, and shows you any additional included default options.

9. Review your selections, check that you have read the Third Party Service Agreements, then click **Create**. The order is verified automatically.

After your order is approved, the provisioning of your IBM Cloud™ Juniper vSRX Virtual Firewall Gateway starts automatically. When the provisioning process is complete, the new vSRX Virtual Firewall appears in the [Gateway Appliances](#) list page. Click the gateway name to open the Gateway Details page. The IP addresses, login username, and password for the device appear. Remember that after you order and configure your gateway from the IBM Cloud catalog, you must also configure the device itself with the same settings.

## Junos OS Features Supported on vSRX Virtual Firewall

### SUMMARY

This topic provides details of the Junos OS features supported and not supported on vSRX Virtual Firewall.

### IN THIS SECTION

- [SRX Series Features Supported on vSRX Virtual Firewall | 604](#)
- [SRX Series Features Not Supported on vSRX Virtual Firewall | 609](#)

### SRX Series Features Supported on vSRX Virtual Firewall

vSRX Virtual Firewall inherits most of the branch SRX Series features with the following considerations shown in [Table 94 on page 604](#).

To determine the Junos OS features supported on vSRX Virtual Firewall, use the Juniper Networks Feature Explorer, a Web-based application that helps you to explore and compare Junos OS feature information to find the right software release and hardware platform for your network. Find Feature Explorer at: [Feature Explorer: vSRX](#).

**Table 94: vSRX Virtual Firewall Feature Considerations**

Feature	Description
IDP	<p>The IDP feature is subscription based and must be purchased. After purchase, you can activate the IDP feature with the license key.</p> <p>For SRX Series IDP configuration details, see:</p> <p><a href="#">Understanding Intrusion Detection and Prevention for SRX Series</a></p>

Table 94: vSRX Virtual Firewall Feature Considerations (*Continued*)

Feature	Description	
IPSec VPNs	<p>Starting in Junos OS Release 19.3R1, vSRX Virtual Firewall supports the following authentication algorithms and encryption algorithms:</p> <ul style="list-style-type: none"> <li>• Authentication algorithm: hmac-sha1-96 and HMAC-SHA-256-128 authentication</li> <li>• Encryption algorithm: aes-128-cbc</li> </ul> <p>Starting in Junos OS Release 20.3R1, vSRX Virtual Firewall supports 10,000 IPsec VPN tunnels.</p> <p>To support the increased number of IPsec VPN tunnels, a minimum of 19 vCPUs are required. Out of the 19 vCPUs, 3 vCPUs must be dedicated to RE.</p> <p>You must run the <code>request system software add optional://junos-ike.tgz</code> command the first time you wish to enable increased IPsec tunnel capacity. For subsequent software upgrades of the instance, the junos-ike package is upgraded automatically from the new Junos OS releases installed in the instance. DH group15, group16, group21 is also added when we install junos-ike package. If chassis cluster is enabled then run this command on both the nodes.</p> <p>You can configure the number of vCPUs allocated to Junos Routing Engine using the <code>set security forwarding-options resource-manager cpu re &lt;value&gt;</code>.</p> <p><b>NOTE:</b> 64 G memory is required to support 10000 tunnels in PMI mode.</p> <p>[See <a href="#">show security ipsec security-associations</a>, <a href="#">show security ike tunnel-map</a>, and <a href="#">show security ipsec tunnel-distribution</a>.]</p>	
IPsec VPN - Tunnel Scaling on vSRX Virtual Firewall	Types of Tunnels	Number of tunnels supported
	Site-Site VPN tunnels	2000
	AutoVPN tunnels	10,000
	IKE SA (Site-to-site)	2000
	IKE SA (AutoVPN)	10,000
	IKE SA (Site-to-site + AutoVPN)	10,000

Table 94: vSRX Virtual Firewall Feature Considerations (*Continued*)

Feature	Description	
	IPSec SA pairs (Site-to-site)	10,000  With 2000 IKE SAs, we can have 10,000 IPSec SA.
	IPSec SA pairs (AutoVPN)	10,000
	Site-to-site + AutoVPN IPSec SA pairs	2000 Site-to-site 8000 AutoVPN
	Site-to-site + AutoVPN tunnels	2000 Site-to-site 8000 AutoVPN
ISSU	ISSU is not supported.	
Logical Systems	<p>Starting in Junos OS Release 20.1R1, you can configure logical systems and tenant systems on vSRX Virtual Firewall and vSRX Virtual Firewall 3.0 instances.</p> <p>With Junos OS, you can partition a single security device into multiple logical devices that can perform independent tasks.</p> <p>Each logical system has its own discrete administrative domain, logical interfaces, routing instances, security firewall and other security features.</p> <p>See <a href="#">Logical Systems Overview</a>.</p>	

Table 94: vSRX Virtual Firewall Feature Considerations (*Continued*)

Feature	Description
PowerMode IPsec	<p data-bbox="495 357 1404 535">Starting in Junos OS Release 20.1R1, vSRX Virtual Firewall 3.0 instances support PowerMode IPsec that provides IPsec performance improvements using Vector Packet Processing (VPP) and Intel AES-NI instructions. PowerMode IPsec is a small software block inside the SRX PFE (SRX Packet Forwarding Engine) that is activated when PowerMode is enabled.</p> <p data-bbox="495 556 925 598">Supported Features in PowerMode IPsec</p> <ul data-bbox="495 619 885 1249" style="list-style-type: none"> <li>• IPsec functionality</li> <li>• Traffic selectors</li> <li>• Secure tunnel interface (st0)</li> <li>• All control plane IKE functionality</li> <li>• Auto VPN with traffic selector</li> <li>• Auto VPN with routing protocol</li> <li>• IPv6</li> <li>• Stateful Layer 4 firewall</li> <li>• High-Availability</li> <li>• NAT-T</li> </ul> <p data-bbox="495 1270 982 1312">Non-Supported Features in PowerMode IPsec</p> <ul data-bbox="495 1333 860 1774" style="list-style-type: none"> <li>• NAT</li> <li>• IPsec in IPsec</li> <li>• GTP/SCTP firewall</li> <li>• Application firewall/AppSecure</li> <li>• QoS</li> <li>• Nested tunnel</li> <li>• Screen</li> </ul>



Table 94: vSRX Virtual Firewall Feature Considerations (*Continued*)

Feature	Description
	<ul style="list-style-type: none"> <li>• Multicast</li> <li>• Host traffic</li> </ul>
Ethernet Switching and Bridging	<p>Starting in Junos OS Release 22.1R1, vSRX Virtual Firewall and vSRX Virtual Firewall 3.0 instances deployed on KVM and VMware platforms support flexible VLAN tagging on revenue and reth interfaces.</p> <p>Flexible VLAN tagging supports transmission of 802.1Q VLAN single-tag frames on logical interfaces on the Ethernet port. Also, avoids multiple virtual functions on the network interface card (NIC) and reduces the need of additional interfaces.</p> <p>[See <a href="#">Configuring VLAN Tagging</a> and <a href="#">flexible-vlan-tagging (Interfaces)</a>.]</p>
Tenant Systems	<p>Starting in Junos OS Release 20.1R1, you can configure tenant systems on vSRX Virtual Firewall and vSRX Virtual Firewall 3.0 instances.</p> <p>A tenant system provides logical partitioning of the SRX Series Firewall into multiple domains similar to logical systems and provides high scalability.</p> <p>See <a href="#">Tenant Systems Overview</a>.</p>
Transparent mode	<p>The known behaviors for transparent mode support on vSRX Virtual Firewall are:</p> <ul style="list-style-type: none"> <li>• The default MAC learning table size is restricted to 16,383 entries.</li> </ul> <p>For information about configuring transparent mode for vSRX Virtual Firewall, see <a href="#">Layer 2 Bridging and Transparent Mode Overview</a>.</p>

Table 94: vSRX Virtual Firewall Feature Considerations (Continued)

Feature	Description
Content Security	<ul style="list-style-type: none"> <li>• The Content Security feature is subscription based and must be purchased. After purchase, you can activate the Content Security feature with the license key.</li> <li>• Starting in Junos OS Release 19.4R1, vSRX Virtual Firewall 3.0 instances support the Avira scan engine, which is an on-device antivirus scanning engine. See <a href="#">On-Device Antivirus Scan Engine</a>.</li> <li>• For SRX Series Content Security configuration details, see <a href="#">Unified Threat Management Overview</a>.</li> <li>• For SRX Series Content Security antispam configuration details, see <a href="#">Antispam Filtering Overview</a>.</li> <li>• <b>Advanced resource management (vSRX 3.0)</b>—Starting in Junos OS Release 19.4R1, vSRX Virtual Firewall 3.0 manages the additional system resource requirements for Content Security-and IDP-specific services by reallocating CPU cores and extra memory. These values for memory and CPU cores are not user configured. Previously, system resources such as memory and CPU cores were fixed.</li> </ul> <p>You can view the allocated CPU and memory for advance security services on vSRX Virtual Firewall 3.0 instance by using the <code>show security forward-options resource-manager settings</code> command. To view the flow session scaling, use the <code>show security monitoring</code> command.</p> <p>[See <a href="#">show security monitoring</a> and <a href="#">show security forward-options resource-manager settings</a>.]</p>
Tunnels	Only GRE and IP-IP

Some Junos OS software features require a license to activate the feature. To understand more about vSRX Virtual Firewall Licenses, see, [Licenses for vSRX](#). Please refer to the [Licensing Guide](#) for general information about License Management. Please refer to the product [Data Sheets](#) for further details, or contact your Juniper Account Team or Juniper Partner.

## SRX Series Features Not Supported on vSRX Virtual Firewall

vSRX Virtual Firewall inherits many features from the SRX Series Firewall product line. [Table 95 on page 610](#) lists SRX Series features that are not applicable in a virtualized environment, that are not currently supported, or that have qualified support on vSRX Virtual Firewall.

**Table 95: SRX Series Features Not Supported on vSRX Virtual Firewall**

SRX Series Feature	vSRX Virtual Firewall Notes
<b>Application Layer Gateways</b>	
Avaya H.323	Not supported
<b>Authentication with IC Series devices</b>	
Layer 2 enforcement in UAC deployments	Not supported <b>NOTE:</b> UAC-IDP and UAC-Content Security also are not supported.
<b>Chassis cluster support</b>	
<b>NOTE:</b> Support for chassis clustering to provide network node redundancy is only available on a vSRX Virtual Firewall deployment in Contrail, VMware, KVM, and Windows Hyper-V Server 2016.	
Chassis cluster for VirtIO driver	Only supported with KVM <b>NOTE:</b> The link status of VirtIO interfaces is always reported as UP, so a vSRX Virtual Firewall chassis cluster cannot receive link up and link down messages from VirtIO interfaces.
Dual control links	Not supported
In-band and low-impact cluster upgrades	Not supported
LAG and LACP (Layer 2 and Layer 3)	Not supported
Layer 2 Ethernet switching	Not supported
Low-latency firewall	Not supported
<b>Class of service</b>	

**Table 95: SRX Series Features Not Supported on vSRX Virtual Firewall (Continued)**

SRX Series Feature	vSRX Virtual Firewall Notes
High-priority queue on SPC	Not supported
Tunnels	A vSRX Virtual Firewall VM deployed on Microsoft Azure Cloud does not support GRE, IP-IP and multicast.
<b>Data plane security log messages (stream mode)</b>	
TLS protocol	Not supported
<b>Diagnostic tools</b>	
Flow monitoring cflowd version 9	Not supported
Ping Ethernet (CFM)	Not supported
Traceroute Ethernet (CFM)	Not supported
<b>DNS proxy</b>	
Dynamic DNS	Not supported
<b>Ethernet link aggregation</b>	
LACP in standalone or chassis cluster mode	Not supported
Layer 3 LAG on routed ports	Not supported
Static LAG in standalone or chassis cluster mode	Not supported
<b>Ethernet link fault management</b>	

Table 95: SRX Series Features Not Supported on vSRX Virtual Firewall (*Continued*)

SRX Series Feature	vSRX Virtual Firewall Notes
<b>Physical interface (encapsulations)</b> <ul style="list-style-type: none"> <li>• ethernet-ccc</li> <li>• ethernet-tcc</li> <li>• extended-vlan-ccc</li> <li>• extended-vlan-tcc</li> </ul>	Not supported
<b>Interface family</b> <ul style="list-style-type: none"> <li>• ccc, tcc</li> <li>• ethernet-switching</li> </ul>	Not supported
<b>Flow-based and packet-based processing</b>	
End-to-end packet debugging	Not supported
Network processor bundling	
Services offloading	
<b>Interfaces</b>	
Aggregated Ethernet interface	Not supported
IEEE 802.1X dynamic VLAN assignment	Not supported
IEEE 802.1X MAC bypass	Not supported
IEEE 802.1X port-based authentication control with multisuppliant support	Not supported

**Table 95: SRX Series Features Not Supported on vSRX Virtual Firewall (Continued)**

SRX Series Feature	vSRX Virtual Firewall Notes
Interleaving using MLFR	Not supported
PoE	Not supported
PPP interface	Not supported
PPPoE-based radio-to-router protocol	Not supported
PPPoE interface <b>NOTE:</b> Starting in Junos OS Release 15.1X49-D100 and Junos OS Release 17.4R1, the vSRX Virtual Firewall supports Point-to-Point Protocol over Ethernet (PPPoE) interface.	Not supported
Promiscuous mode on interfaces	Only supported if enabled on the hypervisor
<b>IPSec and VPNs</b>	
Acadia - Clientless VPN	Not supported
DVPN	Not supported
Hardware IPsec (bulk crypto) Cavium/RMI	Not supported
IPsec tunnel termination in routing instances	Supported on virtual router only
Multicast for AutoVPN	Not supported
<b>IPv6 support</b>	
DS-Lite concentrator (also called Address Family Transition Router [AFTR])	Not supported

**Table 95: SRX Series Features Not Supported on vSRX Virtual Firewall (Continued)**

SRX Series Feature	vSRX Virtual Firewall Notes
DS-Lite initiator (aka B4)	Not supported
<b>J-Web</b>	
Enhanced routing configuration	Not supported
New Setup wizard (for new configurations)	Not supported
PPPoE wizard	Not supported
Remote VPN wizard	Not supported
Rescue link on dashboard	Not supported
Content Security configuration for Kaspersky antivirus and the default Web filtering profile	Not supported
<b>Log file formats for system (control plane) logs</b>	
Binary format (binary)	Not supported
WELF	Not supported
<b>Miscellaneous</b>	
GPRS <b>NOTE:</b> Starting in Junos OS Release 15.1X49-D70 and Junos OS Release 17.3R1, vSRX Virtual Firewall supports GPRS.	Not supported
Hardware acceleration	Not supported

Table 95: SRX Series Features Not Supported on vSRX Virtual Firewall (*Continued*)

SRX Series Feature	vSRX Virtual Firewall Notes
Outbound SSH	Not supported
Remote instance access	Not supported
USB modem	Not supported
Wireless LAN	Not supported
<b>MPLS</b>	
Circuit cross-connect (CCC) and translational cross-connect (TCC)	Not supported
Layer 2 VPNs for Ethernet connections	Only if promiscuous mode is enabled on the hypervisor
<b>Network Address Translation</b>	
Maximize persistent NAT bindings	Not supported
<b>Packet capture</b>	
Packet capture	Only supported on physical interfaces and tunnel interfaces, such as <i>gr</i> , <i>ip</i> , and <i>st0</i> . Packet capture is not supported on redundant Ethernet interfaces ( <i>reth</i> ).
<b>Routing</b>	
BGP extensions for IPv6	Not supported
BGP Flowspec	Not supported
BGP route reflector	Not supported



Table 95: SRX Series Features Not Supported on vSRX Virtual Firewall (*Continued*)

SRX Series Feature	vSRX Virtual Firewall Notes
C RTP	Not supported
<b>Switching</b>	
Layer 3 Q-in-Q VLAN tagging	Not supported
<b>Transparent mode</b>	
Content Security	Not supported
<b>Content Security</b>	
Express AV	Not supported
Kaspersky AV	Not supported
<b>Upgrading and rebooting</b>	
Autorecovery	Not supported
Boot instance configuration	Not supported
Boot instance recovery	Not supported
Dual-root partitioning	Not supported
OS rollback	Not supported
<b>User interfaces</b>	
NSM	Not supported

**Table 95: SRX Series Features Not Supported on vSRX Virtual Firewall (Continued)**

SRX Series Feature	vSRX Virtual Firewall Notes
SRC application	Not supported
Junos Space Virtual Director	Only supported with VMware

# Installing and Configuring vSRX Virtual Firewall in IBM

## IN THIS CHAPTER

- [Performing vSRX Virtual Firewall Basics in IBM Cloud | 618](#)
- [vSRX Virtual Firewall Readiness Checks in IBM Cloud | 623](#)
- [Managing VLANs with a gateway appliance | 626](#)
- [Working with the vSRX Virtual Firewall Default Configurations | 628](#)
- [Migrating Legacy Configurations to the Current vSRX Virtual Firewall Architecture | 633](#)
- [Allowing SSH and Ping to a Public Subnet | 642](#)
- [Performing vSRX Virtual Firewall Advanced Tasks in IBM Cloud | 643](#)
- [Upgrading the vSRX Virtual Firewall in IBM Cloud | 657](#)

## Performing vSRX Virtual Firewall Basics in IBM Cloud

### IN THIS SECTION

- [Viewing all gateway appliances | 619](#)
- [Viewing gateway appliance details | 619](#)
- [Renaming a gateway appliance | 619](#)
- [Canceling a gateway appliance | 620](#)
- [Performing additional vSRX Virtual Firewall tasks | 620](#)

## Viewing all gateway appliances

The Gateway Appliances page in the IBM Cloud® console is where you can view and access all network gateway appliances, including IBM Virtual Router Appliances and IBM Juniper vSRX Virtual Firewall Standard.

Perform the following procedure to access the **Gateway Appliances** page in the IBM Cloud console:

1. From your browser, open the [IBM Cloud catalog](#) and log in to your account.
2. Select the **Menu** from the top left, then click **Classic Infrastructure**.
3. Choose **Network > Gateway Appliances**.

## Viewing gateway appliance details

Network gateways are used to control network traffic on a VLAN that is regularly controlled by a router. Within the Gateway Appliance Details page on the IBM Cloud console, you can associate, disassociate, route and bypass VLANs associated with a network gateway.

Perform the following procedure to go to the **Gateway Appliance Details** page.

1. From your browser, open the [IBM Cloud catalog](#) and log in to your account.
2. Select the **Menu** from the top left, then click **Classic Infrastructure**.
3. Choose **Network > Gateway Appliances**.
4. Click the name of the network gateway you want to view to access the Gateway Appliance Details page. Use the Bulk Actions feature to take action on multiple VLANs at the same time.

## Renaming a gateway appliance

Network gateways are given unique names that assist users in their identification. At any time, you can change a gateway name using the instructions here. It is recommended that you use a consistent naming convention to more easily identify gateways.

Perform the following procedure to rename a network gateway:

1. Access the [Gateway Appliance Details](#) page in the IBM Cloud console.
2. Click the **Actions** menu and select **Rename Gateway**.
3. Enter the new gateway name in the **Gateway Name** field.
4. Click **OK** to save the change.

After changing a gateway appliance's name, the name immediately changes at the top of the Gateway Appliance Details page. You can change the gateway name at any time by repeating these steps.

**NOTE:** Changing the name of the gateway appliance in the IBM Cloud console does not automatically change the hostname within the Virtual Router Appliance or any DNS entries that you might have. Changing the hostname requires manual intervention.

## Canceling a gateway appliance

You can cancel your gateway appliance at any time by following these instructions.

1. From your browser, open the [IBM Cloud catalog](#) and log in to your account.
2. Select the **Menu** from the top left, then click **Classic Infrastructure**.
3. Choose **Network > Gateway Appliances**.
4. Click the Gateway Appliance name to open the Gateway Appliance Details page.
5. From the Hardware section, click the name of the hardware member to open the server details page.
6. Select **Actions > Cancel device** and follow the prompts to cancel the gateway appliance.

**NOTE:** For Highly Available server pairs, you must select and cancel both server members listed in the Hardware section on the Gateway Appliance Details page to cancel the gateway.

After you cancel the gateway appliance, the server(s) are reclaimed at the next billing cycle. For example, if you cancel the server(s) on September 8, the service is available until it is reclaimed on October 1.

You can verify if your gateway appliance is in the process of being canceled by viewing the Gateway Appliance Details page. Gateways in the process of being canceled show as Cancel pending.

**NOTE:** If necessary, you can expedite the process by opening a case with IBM Support and requesting that the gateway appliance be reclaimed immediately. This process can take 24 to 48 hours.

## Performing additional vSRX Virtual Firewall tasks

### IN THIS SECTION

- [Accessing the device using SSH | 621](#)

- [Accessing the configuration mode | 621](#)
- [Accessing the Device using the Juniper web management UI | 622](#)
- [Creating system users | 622](#)
- [Defining the vSRX Virtual Firewall hostname | 622](#)
- [Configuring DNS and NTP | 622](#)
- [Changing the root password | 622](#)

You can configure and maintain your IBM Cloud™ Juniper vSRX Virtual Firewall in a variety of ways, either through a remote console session through SSH or by logging into the Juniper web management GUI.

**NOTE:** Configuring the vSRX Virtual Firewall outside of its shell and interface may produce unexpected results and is not recommended.

### Accessing the device using SSH

You can access either the vSRX Virtual Firewall or the host (Ubuntu) using SSH through a private IP address if you're on IBM Cloud VPN. Additionally, you can access the vSRX Virtual Firewall through a public IP address as well.

1. Go to Gateway Appliance Details screen and get the Public gateway IP or Private Gateway IP.
2. Click the "eye" icon to reveal the admin user's password.
3. For a vSRX Virtual Firewall, run the command `ssh admin@<gateway-ip>`, then enter the admin user's password. You can also use the 'root' user ID and password.

**NOTE:** For the host (Ubuntu), you can only use the root user ID and password. Also, if you do not see the "eye" icon, you may not have permission to view the password. Please check your access permissions with the account owner.

### Accessing the configuration mode

You can enter the configuration mode, once a shell has been opened to the vSRX Virtual Firewall, by running the `config` command. You can do several things in this mode using the following commands:

- show - View configurations
- show | compare - View staged changes
- set - Stage changes
- commit check - Verify the syntax of the configuration

If you are happy with your changes, you can commit them to the active configuration by running the commands `commit` and then `save`. To leave Configuration mode run the command `exit`.

### Accessing the Device using the Juniper web management UI

The Juniper web management GUI has been configured by default, with vSRX Virtual Firewall generated self-signed certificate. Only https is enabled on port 8443. You can access it at <https://gateway-ip:8443>.

### Creating system users

By default, the IBM Cloud™ Juniper vSRX Virtual Firewall is configured with SSH access for the username `admin`. Additional users can be added with their own set of priorities. For example: **`set system login user ops class operator authentication encrypted-password <CYPHER>`**. In this example, `ops` is the username and `operator` is the class/permission level assigned to the user. Customized classes can be also defined as opposed to pre-defined ones.

### Defining the vSRX Virtual Firewall hostname

You can set or change the vSRX Virtual Firewall hostname using the following command: `set system host-name <hostname>`

### Configuring DNS and NTP

To configure name server resolution and NTP, run the following commands:

- `set system name-server <DNS server>`
- `set system ntp <NTP server>`

### Changing the root password

You can change the root password by running the following command: **`set system root-authentication plain-text-password`**. This prompts you to input a new password, which is encrypted and stored in the configuration, and is not visible.

## vSRX Virtual Firewall Readiness Checks in IBM Cloud

### IN THIS SECTION

- [Checking vSRX Virtual Firewall readiness | 623](#)
- [Readiness status | 624](#)
- [Correcting readiness errors | 624](#)

### Checking vSRX Virtual Firewall readiness

A readiness check verifies the ability of your IBM Cloud™ Juniper vSRX Virtual Firewall to perform certain gateway actions. They include:

- OS reloads
- License upgrades
- Version upgrades

Once you run the readiness check, errors will alert you to any necessary actions you should take before beginning one of these actions, or inform you that you're ready to proceed.

To run a readiness check, perform the following procedure:

1. From your browser, open the [IBM Cloud catalog](#) and log in to your account.
2. Select the **Menu** from the top left, then click **Classic Infrastructure**.
3. Choose **Network > Gateway Appliances**.
4. Click the name of the vSRX Virtual Firewall you want to run a readiness check on.
5. Find the Readiness Check module on the vSRX Virtual Firewall details page.
6. Click the **Run** check button.
7. The details page for your vSRX Virtual Firewall displays again, as do the test results in the readiness check module.

**NOTE:** Ensure the status for any action you wish to perform is Ready before beginning that action.



## Readiness status

There are seven unique status conditions for the readiness check that you may encounter.

- **Unchecked**—A readiness check has not yet been run for this action.
- **Expired**—The readiness check has not run recently enough to reflect accurate results. Run a new check to see the current status.
- **Ready**—Your vSRX Virtual Firewall is ready to perform the given action.
- **Not Ready**—Your vSRX Virtual Firewall is not ready to perform the action in question. This could occur because of several reasons. Either a readiness check error occurred, or the readiness check did not complete fast enough, and timed out.

Error messages for the issues found during the readiness check display next to the module. Click on the error codes to get more information on each error. Alternatively, you can find information about each error in the topic [Understanding readiness errors](#).

- **Running**—The readiness check is currently running on your vSRX Virtual Firewall, and has not currently encountered any errors.
- **Incomplete**—The first member of the gateway's highly available (HA) setup failed the readiness check. As a result, the gateway could not complete the readiness check.
- **Unsupported**—The action you are attempting to check is not supported for this gateway.
- **Current**— The action you are attempting to check does not need to be performed, as the gateway already has the latest version available.

Readiness check errors you may encounter can either be common errors or version upgrade errors. The below lists provide additional information on these error codes.

To understand common errors that might occur when running readiness checks, see [Common readiness errors](#).

## Correcting readiness errors

There are two categories of errors you might encounter when performing readiness checks:

- Host (Ubuntu) SSH connectivity errors
- Gateway (vSRX Virtual Firewall) SSH connectivity errors

Many of these errors result from the fact that the gateway actions being checked require root SSH access to the private IP address for either the Ubuntu (Host) OS or the vSRX Virtual Firewall (Gateway). If a SSH connectivity check fails, then the action cannot proceed.

For details on how to ensure that the SSH session can be established, refer to [Accessing the device using SSH](#). Note that for step 3, the example given is with the admin user. For a readiness check, substitute the root user for both the vSRX Virtual Firewall and the Hardware (host). Also, make sure you use your private IP with this procedure, not your public one.

To validate connectivity, open an SSH session to either the Ubuntu host's or vSRX Virtual Firewall's private IP using the root credentials listed in the Hardware section (for an Ubuntu host) or the vSRX Virtual Firewall section (for the gateway) of the Gateway Details page. Ensure that the SSH session can be established.

If the session cannot be established, check the potential following issues:

- **For Host (Ubuntu) SSH connectivity errors:**

- Is the Ubuntu firewall blocking SSH access to the private IP? The firewall rules must allow SSH access to the private 10.0.0.0/8 subnet. For more information on IBM Cloud IP Ranges for the service network, see [IBM Cloud IP ranges](#).
- Is the root password listed on the Gateway Details page the correct password for the root user? If not, click the device link under the Hardware section and navigate to Passwords. Select **Actions** > **Edit credentials** and change the password to match the actual root password on the Ubuntu host.
- Is the root login disabled for the SSH server? Is the SSH server disabled or stopped?
- Is the root user account disabled on the Ubuntu host?

- **For Gateway (vSRX) SSH connectivity errors:**

- Is the vSRX Virtual Firewall firewall blocking SSH access to the private IP? The firewall rules must allow SSH access to the private 10.0.0.0/8 subnet. For more information on IBM Cloud IP Ranges for the service network, see [IBM Cloud IP ranges](#).
- Is the root password listed on the Gateway Details page the correct password for the root user? If not, click the Edit icon next to the root password and change the password to match the actual root password for the vSRX Virtual Firewall.
- Is the root user account disabled for SSH access to the vSRX Virtual Firewall?

## Managing VLANs with a gateway appliance

### IN THIS SECTION

- [Associating a VLAN to a gateway appliance | 626](#)
- [Routing an associated VLAN | 626](#)
- [Bypassing gateway appliance routing for a VLAN | 627](#)
- [Disassociating a VLAN from a gateway appliance | 627](#)

You can manage, associate, disassociate, route, and bypass VLANs with a gateway appliance. You can perform these actions from the [Gateway Appliance Details](#) page.

### Associating a VLAN to a gateway appliance

A VLAN must be associated to a gateway appliance before it can be routed. VLAN association is the linking of an eligible VLAN to a network gateway so that it can be routed to a gateway appliance in the future. The process of association does not automatically route a VLAN to a gateway appliance; the VLAN continues to use front-end and back-end customer routers until it is routed to the gateway.

VLANs can be associated to only one gateway at a time and must not have a firewall. Perform the following procedure to associate a VLAN to a network gateway.

- Access the [Gateway Appliance Details](#) page in the IBM Cloud console.
- Select the VLAN you want from the **Associate a VLAN** list.
- Click the **Associate** button to associate the VLAN.

After associating a VLAN to the gateway appliance, it appears in the Associated VLANs section of the Gateway Appliance Details page. From this section, the VLAN can be routed to the gateway, or be disassociated from the gateway. Additional eligible VLANs can be associated to a gateway appliance at any time by repeating these steps.

### Routing an associated VLAN

Associated VLANs are linked to a gateway appliance, but traffic in and out of the VLAN does not hit the gateway until the VLAN is routed. After an associated VLAN is routed, all front-end and back-end traffic is routed through the gateway appliance as opposed to customer routers.

Perform the following procedure to route an associated VLAN:

- Access the [Gateway Appliance Details](#) page in the IBM Cloud console.
- Select the VLAN you want from the **Associate a VLAN** list.
- Click the **Associate** button to associate the VLAN.
- Select **Route VLAN** from the Actions menu.
- Click **Yes** to route the VLAN.

After routing a VLAN, all front-end and back-end traffic moves from the customer routers to the network gateway. Additional controls related to traffic and the gateway appliance itself can be taken by accessing the gateway's management tool. Routing through the network gateway can be discontinued at any time by bypassing the gateway appliance.

### **Bypassing gateway appliance routing for a VLAN**

After a VLAN is routed, all front-end and back-end traffic travels through the network gateway. At any time, the gateway appliance can be bypassed so that traffic returns to the front-end and back-end customer routers (FCR and BCR).

Bypassing a VLAN allows the VLAN to remain associated to the network gateway. If the VLAN should no longer be associated with the gateway appliance, see [Disassociating a VLAN from a gateway appliance](#).

Perform the following procedure to bypass gateway routing for a VLAN:

- Access the [Gateway Appliance Details](#) page in the IBM Cloud console.
- Select the VLAN you want from the **Associate a VLAN** list.
- Select **Bypass VLAN** from the Actions menu.
- Select **Route VLAN** from the Actions menu.
- Click **Yes** to bypass the gateway.

After bypassing the network gateway, all front-end and back-end traffic routes through the FCR and BCR associated with the VLAN. The VLAN remains associated with the gateway appliance and can be routed back to the gateway appliance at any time.

### **Disassociating a VLAN from a gateway appliance**

VLANs can be linked to one gateway appliance at a time through association. Association allows the VLAN to be routed to the gateway appliance at any time. If a VLAN should be associated to another gateway appliance, or if the VLAN should no longer be associated to its gateway, disassociation is required. Disassociation removes the "link" from the VLAN to the gateway appliance, allowing it to be associated to another gateway, if necessary.

Bypassing a VLAN allows the VLAN to remain associated to the network gateway. If the VLAN should no longer be associated with the gateway appliance, see [Disassociating a VLAN from a gateway appliance](#).

Perform the following procedure to disassociate a VLAN from a gateway appliance:

- Access the [Gateway Appliance Details](#) page in the IBM Cloud console.
- Select the VLAN you want from the **Associate a VLAN** list.
- Select **Disassociate** from the Actions menu.
- Select **Route VLAN** from the Actions menu.
- Click **Yes** to disassociate the VLAN.

After disassociating a VLAN from a gateway appliance, the VLAN can be associated to another gateway. The VLAN can also be associated back to the gateway appliance at any time. After disassociating a VLAN from a gateway appliance, the VLAN's traffic cannot be routed through the gateway. VLANs must be associated to a gateway appliance before they can be routed.

## Working with the vSRX Virtual Firewall Default Configurations

### IN THIS SECTION

- [Understanding the vSRX Virtual Firewall default configuration | 628](#)
- [Importing and Exporting a vSRX Virtual Firewall Configuration | 629](#)
- [Exporting part of the vSRX Virtual Firewall configuration | 630](#)
- [Importing the entire vSRX Virtual Firewall configuration | 631](#)
- [Importing part of the vSRX Virtual Firewall configuration | 631](#)

## Understanding the vSRX Virtual Firewall default configuration

### IN THIS SECTION

- [Reference Default Configuration Samples | 629](#)

IBM Cloud™ Juniper vSRX Virtual Firewall devices come with following default configuration:

- SSH and Ping are permitted on both vSRX Virtual Firewall public and private gateway IP addresses
- Juniper Web Management (J-Web) UI access is permitted on HTTPS port 8443 for both public and private gateway IP addresses
- An address-set SERVICE is predefined for IBM service networks
- Two security zones: SL-PRIVATE and SL-PUBLIC are predefined.
- Access from the zone SL-PRIVATE to all services is provided by IBM and address-set SERVICE is permitted
- All other network accesses are denied

Two redundancy groups are configured are illustrated below:

Redundancy group	Redundancy group function
redundancy-group 0	Redundancy group for control plane
redundancy-group 1	Redundancy group for data plane

Priority in the redundancy group decides which vSRX Virtual Firewall node is active. By default, node 0 is active for both control plane and data plane.

### Reference Default Configuration Samples

- [Default Configuration of a sample 1G Standalone SR-IOV Public and Private vSRX Gateway](#)
- [Default Configuration of a sample 10G HA SR-IOV Public and Private vSRX Gateway](#)

## Importing and Exporting a vSRX Virtual Firewall Configuration

### IN THIS SECTION

- [Considerations | 630](#)

The IBM Cloud™ Juniper vSRX Virtual Firewall upgrade process preserves the original configuration of the vSRX Virtual Firewall throughout the entire process, as long as the required reloads are done one at

a time. However, it is still strongly recommended to export and backup your vSRX Virtual Firewall configuration settings before starting the upgrade.

After the upgrade process completes for stand alone servers, you should import the original configuration you saved if you want to restore it. For High Availability configurations, you should restore the configuration manually from your exported file only if the upgrade fails or if moving between architectures. For more information on migrating 1G configurations from the legacy architecture to the current architecture, see [Migrating legacy configurations to the current vSRX architecture](#).

## Considerations

- The upgrade process for Standalone and High Availability (HA) are different. See [Upgrading the vSRX](#).
- The J-Web interface allows you to display, edit, and upload the current configuration quickly and easily without using the Junos OS CLI. See [J-Web for SRX Series Documentation](#) for more details.
- An upgrade from the vSRX Virtual Firewall 15.1 release to a newer vSRX Virtual Firewall release, such as 19.4, results in changes to the vSRX Virtual Firewall interface mappings in the configuration file. As a result, when importing your original vSRX Virtual Firewall settings, make sure that the new “interfaces” section is not modified. There are two ways of doing this: Either import sub-sections other than the “interfaces” section, or import the entire configuration and manually restore the 19.4 SR-IOV interfaces.

The new vSRX Virtual Firewall default interface configuration for both the Linux Bridge and SR-IOV must be preserved after the import of their configurations. For example, for SR-IOV the GE interfaces have specific mappings to the host that must be preserved to enable SR-IOV. These interfaces are found in the CLI using the command `show configuration interfaces`. See [vSRX default configurations](#) section for more information on SR-IOV mappings. See [Migrating legacy configurations to the current vSRX architecture](#) for details on migrating 1G configurations from the legacy architecture to the current architecture.

If you prefer using the Junos OS CLI, the following contents provide different methods to export and import your configuration settings, depending on whether you want to export or import the entire configuration or just part of it. To manage the configuration settings, enter CLI mode, then run the command `configure` to enter configuration mode. Then to commit your changes, run the command `commit`.

## Exporting part of the vSRX Virtual Firewall configuration

To export only part of the vSRX Virtual Firewall configuration:

1. Enter configuration mode and ensure you are at the top of the configuration tree: `edit` then `top`
2. Then run the `show <section>` command to get the current configuration, enclosed in braces.

For example, you can run `show interfaces` to show all the interfaces configuration. Or, if you prefer to display the output in set mode, run the `show <section> | display set` command.

The output should be similar to the following:

```
# show interfaces | display set
set interfaces ge-0/0/0 description PRIVATE_VLANS
set interfaces ge-0/0/0 flexible-vlan-tagging
set interfaces ge-0/0/0 native-vlan-id 925
set interfaces ge-0/0/0 mtu 9000
...

[edit]
```

**TIP:** Set mode displays the configuration as a series of configuration mode commands required to re-create the configuration. This is useful if you are not familiar with how to use configuration mode commands or if you want to cut, paste, and edit the displayed configuration.

3. Copy and save the output into your local workspace for later use.

### Importing the entire vSRX Virtual Firewall configuration

The new vSRX Virtual Firewall default interface configuration for both the Linux Bridge and SR-IOV must be preserved after the import of their configurations. For example, for SR-IOV the GE interfaces have specific mappings to the host that must be preserved to enable SR-IOV. These interfaces are found in the CLI using the `show configuration interfaces` command. For more information on SR-IOV mappings, see [vSRX default configuration](#).

To import the entire vSRX Virtual Firewall configuration:

1. After upgrading the vSRX Virtual Firewall, copy the config file you saved earlier back to the `/var/tmp` folder.
2. Run `load override /var/tmp/backup.txt` under the configuration mode to replace the entire current configuration with the content that you saved under the `/var/tmp` folder.

### Importing part of the vSRX Virtual Firewall configuration

The new vSRX Virtual Firewall default interface configuration for both the Linux Bridge and SR-IOV must be preserved after the import of their configurations. For example, for SR-IOV the GE interfaces have specific mappings to the host that must be preserved to enable SR-IOV. These interfaces are found



in the CLI using the `show configuration interfaces` command. For more information on SR-IOV mappings, see [vSRX default configuration](#).

To import only part of the vSRX Virtual Firewall configuration:

1. From the configuration mode, run `edit <section>` to go to the configuration tree level that you want.
2. Copy the configuration settings you have saved and run the command `load merge terminal relative` to merge the configuration with the current one.
3. Paste the content, hit Enter to go to a new line, then type Control + D to end the input.

The output should be similar to the following:

```
# load merge terminal relative
[Type ^D at a new line to end input]
family inet {
    filter {
        input PROTECT-IN;
    }
}
load complete

[edit interfaces lo0 unit 0]
```

Alternatively, you can also:

1. Replace the configuration instead of merging it, by deleting the configuration first with the command `delete` under this configuration tree level and then performing a `load merge terminal relative` to copy and paste your previous configuration.
2. Edit the configuration in set mode, by running `load set terminal` instead of `load merge terminal relative`. Then copy and paste the content you saved in set mode.

**NOTE:** Ensure that you always run the `load set terminal` at the top.

## Migrating Legacy Configurations to the Current vSRX Virtual Firewall Architecture

### IN THIS SECTION

- [Migrating 1G vSRX Virtual Firewall Standalone Configurations | 633](#)
- [Migrating 1G vSRX Virtual Firewall High Availability configurations | 641](#)

Migrating IBM Cloud™ Juniper vSRX Virtual Firewall configurations from the legacy to the current architecture requires careful consideration.

vSRX Virtual Firewall 18.4 deployments leverage the current architecture in most cases. This includes the vSRX Virtual Firewall 18.4 1G SR-IOV offering. The older vSRX Virtual Firewall 18.4 1G Standard offering is based on Linux Bridging and has different network configurations on the Ubuntu host, the KVM hypervisor, and in the vSRX Virtual Firewall configuration. The host and KVM settings do not require any special migration steps, as the automation process handles the configuration changes. However, if you want to import the vSRX Virtual Firewall configuration from the legacy architecture into the current vSRX Virtual Firewall configuration, you likely need to refactor some of the configuration.

### Migrating 1G vSRX Virtual Firewall Standalone Configurations

#### IN THIS SECTION

- [Converting the Interface Section | 640](#)
- [Converting the Zones Section | 641](#)
- [Other Changes | 641](#)

There are some steps you potentially need to convert vSRX Virtual Firewall configuration settings on a Standalone 18.4 1G Public+Private Linux Bridge (legacy architecture) instance to a Standalone 18.4 1G Public+Private SR-IOV (current architecture) instance. You can find a sample default configuration for SR-IOV based current architecture [Default Configuration of a sample 1G Standalone SR-IOV Public and Private vSRX Gateway](#).

The following is a sample default configuration for the Linux Bridge (legacy architecture). The example shows vSRX Virtual Firewall instances that were provisioned in different Datacenter pods. As a result, the transit VLAN's (native-vlan-id) are different.

```
## Last commit: 2020-04-16 22:48:33 UTC by root
version 18.4R1-S1.3;
system {
  login {
    class security {
      permissions [ security-control view-configuration ];
    }
    user admin {
      uid 2000;
      class super-user;
      authentication {
        encrypted-password "$6$vKPIcB3I
$X1DRg30to9tLa7zRPka1SfonrKUEJI7U16XX21rke3k2sPaV.CY0CJhSBIPx5aXhqo7h1GWPPhMbv0Ce1WAN0."; ##
SECRET-DATA
      }
    }
  }
  root-authentication {
    encrypted-password "$6$cbXBMc8b
$jHd6LtR40jXvjmgubQXAl ofNonk6lLbNPs35beda7ffEV4XKEUQiEf1XUA3mMvJv2V1YET3kiWBogqz8h2zB7."; ##
SECRET-DATA
  }
  services {
    ssh {
      root-login allow;
    }
    netconf {
      ssh {
        port 830;
      }
    }
    web-management {
      http {
        interface fxp0.0;
      }
      https {
        port 8443;
        system-generated-certificate;
      }
    }
  }
}
```

```
        interface [ fxp0.0 ge-0/0/0.0 ge-0/0/1.0 ];
    }
    session {
        session-limit 100;
    }
}
host-name asloma-e2e-tc15-18-1g-1270-sa-vsrx-vSRX;
name-server {
    10.0.80.11;
    10.0.80.12;
}
syslog {
    user * {
        any emergency;
    }
    file messages {
        any any;
        authorization info;
    }
    file interactive-commands {
        interactive-commands any;
    }
}
ntp {
    server 10.0.77.54;
}
}
security {
    log {
        mode stream;
        report;
    }
    address-book {
        global {
            address SL8 10.1.192.0/20;
            address SL9 10.1.160.0/20;
            address SL4 10.2.128.0/20;
            address SL5 10.1.176.0/20;
            address SL6 10.1.64.0/19;
            address SL7 10.1.96.0/19;
            address SL1 10.0.64.0/19;
            address SL2 10.1.128.0/19;
```

```
address SL3 10.0.86.0/24;
address SL20 10.3.80.0/20;
address SL18 10.2.176.0/20;
address SL19 10.3.64.0/20;
address SL16 10.2.144.0/20;
address SL17 10.2.48.0/20;
address SL14 10.1.208.0/20;
address SL15 10.2.80.0/20;
address SL12 10.2.112.0/20;
address SL13 10.2.160.0/20;
address SL10 10.2.32.0/20;
address SL11 10.2.64.0/20;
address SL_PRIV_MGMT 10.129.33.87/32;
address SL_PUB_MGMT 161.202.136.77/32;
address-set SERVICE {
    address SL8;
    address SL9;
    address SL4;
    address SL5;
    address SL6;
    address SL7;
    address SL1;
    address SL2;
    address SL3;
    address SL20;
    address SL18;
    address SL19;
    address SL16;
    address SL17;
    address SL14;
    address SL15;
    address SL12;
    address SL13;
    address SL10;
    address SL11;
}
}
}
screen {
    ids-option untrust-screen {
        icmp {
            ping-death;
        }
    }
}
```

```

ip {
    source-route-option;
    tear-drop;
}
tcp {
    syn-flood {
        alarm-threshold 1024;
        attack-threshold 200;
        source-threshold 1024;
        destination-threshold 2048;
        queue-size 2000; ## Warning: 'queue-size' is deprecated
        timeout 20;
    }
    land;
}
}
policies {
    from-zone SL-PRIVATE to-zone SL-PRIVATE {
        policy Allow_Management {
            match {
                source-address any;
                destination-address [ SL_PRIV_MGMT SERVICE ];
                application any;
            }
            then {
                permit;
            }
        }
    }
    from-zone SL-PUBLIC to-zone SL-PUBLIC {
        policy Allow_Management {
            match {
                source-address any;
                destination-address SL_PUB_MGMT;
                application [ junos-ssh junos-https junos-http junos-icmp-ping ];
            }
            then {
                permit;
            }
        }
    }
}
}

```

```
zones {
  security-zone SL-PRIVATE {
    interfaces {
      ge-0/0/0.0 {
        host-inbound-traffic {
          system-services {
            all;
          }
        }
      }
    }
  }
  security-zone SL-PUBLIC {
    interfaces {
      ge-0/0/1.0 {
        host-inbound-traffic {
          system-services {
            all;
          }
        }
      }
    }
  }
}

interfaces {
  ge-0/0/0 {
    description PRIVATE_VLANS;
    flexible-vlan-tagging;
    native-vlan-id 1214;
    unit 0 {
      vlan-id 1214;
      family inet {
        address 10.129.33.87/26;
      }
    }
  }
  ge-0/0/1 {
    description PUBLIC_VLAN;
    flexible-vlan-tagging;
    native-vlan-id 764;
    unit 0 {
      vlan-id 764;
    }
  }
}
```

```
    family inet {
        address 161.202.136.77/29;
    }
    family inet6 {
        address 2401:c900:1001:0210:0000:0000:0000:000a/64;
    }
}
fxp0 {
    unit 0;
}
lo0 {
    unit 0 {
        family inet {
            filter {
                input PROTECT-IN;
            }
            address 127.0.0.1/32;
        }
    }
}
firewall {
    filter PROTECT-IN {
        term PING {
            from {
                destination-address {
                    161.202.136.77/32;
                    10.129.33.87/32;
                }
                protocol icmp;
            }
            then accept;
        }
        term SSH {
            from {
                destination-address {
                    161.202.136.77/32;
                    10.129.33.87/32;
                }
                protocol tcp;
                destination-port ssh;
            }
        }
    }
}
```



```

        then accept;
    }
    term WEB {
        from {
            destination-address {
                161.202.136.77/32;
                10.129.33.87/32;
            }
            protocol tcp;
            port 8443;
        }
        then accept;
    }
    term DNS {
        from {
            protocol udp;
            source-port 53;
        }
        then accept;
    }
}
}
routing-options {
    static {
        route 166.9.0.0/16 next-hop 10.129.33.65;
        route 0.0.0.0/0 next-hop 161.202.136.73;
        route 161.26.0.0/16 next-hop 10.129.33.65;
        route 10.0.0.0/8 next-hop 10.129.33.65;
    }
}
}

```

### Converting the Interface Section

In the above 1G Public+Private Standalone example, the current architecture adds aggregated interfaces ae0 and ae1. These should map to what the legacy architecture defines as ge-0/0/0 (private / ae0) and ge-0/0/1 (public / ae1). Additionally, the new architecture adds ge-0/0/2 and ge-0/0/3 to support redundancy within the vSRX Virtual Firewall interfaces. In the old architecture, redundancy existed at the host (Hypervisor) bond interfaces (bond0 private / bond1 public). In the current architecture, SR-IOV VF's that map directly to the ge interfaces are used for redundancy.

You can compare these vSRX Virtual Firewall configuration differences in [vSRX Standalone interface \(current architecture\)](#) and [vSRX Standalone interface \(legacy architecture\)](#).

Any private VLAN's that were previously configured for ge-0/0/0 need to be routed through ae0. In addition, any public VLAN's that you previously configured for ge-0/0/1 need to be routed through ae1.

### Converting the Zones Section

Any default security zones that previously referenced ge-0/0/0 and ge-0/0/1 should now use the ae0.0 (SL-PRIVATE) and ae1.0 (SL-PUBLIC) interfaces. The same changes also apply to any zones that previously referenced ge-0/0/0 and ge-0/0/1.

### Other Changes

- The aggregated device configuration requires the following addition in the current architecture:

```
set chassis aggregated-devices ethernet device-count 10
```

- The JWEB configuration will also include the aggregated interfaces as well:

```
set system services web-management https interface ae1.0
```

```
set system services web-management https interface ae0.0
```

### Migrating 1G vSRX Virtual Firewall High Availability configurations

For High Availability configurations, the main vSRX Virtual Firewall changes when importing configurations from the legacy architecture to the current architecture are small changes to the interface mappings.

The 1G SR-IOV HA configuration for the current architecture adds additional vSRX Virtual Firewall interfaces for redundancy, instead of using the host (hypervisor) bond interfaces. This is possible as the host now uses SR-IOV VF's that can be mapped directly to the vSRX Virtual Firewall interfaces. Configurations that were exported from the legacy architecture will need to take this into account if they are imported into the current architecture.

For vSRX Virtual Firewall configuration for the current architecture for 1G HA, see [vSRX High Availability interfaces \(current architecture\)](#) and for vSRX Virtual Firewall configuration for the legacy architecture for 1G HA, see [vSRX High Availability interfaces \(legacy architecture\)](#).

The extra ge-0/\* and ge-7/\* interfaces were added and associated with the existing reth interfaces which have been present in both the legacy and current architecture. These allow for redundancy within the vSRX Virtual Firewall configuration. Redundancy is also configured for the fab interfaces as well.

## Allowing SSH and Ping to a Public Subnet

### IN THIS SECTION

- [Allowing SSH and Ping to a Public Subnet | 642](#)

### Allowing SSH and Ping to a Public Subnet

In this topic, learn how to configure the IBM Cloud™ Juniper vSRX Virtual Firewall Standard with a new interface, zone, and address-book. As the default action for all traffic is to drop, this guide shows how to set up traffic flows that allow all traffic within the new zone, all traffic from the new zone to the internet, and allow only SSH and ping from the internet to one subnet on the new VLAN.

In this example, the values used are - Public vlan: 1523 Public subnet: 169.47.211.152/29.

**NOTE:** This step-by-step assumes that a high-availability deployment of the vSRX Virtual Firewall, with a single Public VLAN and subnet.

Follow the steps listed to configure the service:

Task	Description
<a href="#">Create a new interface, zone, and address-book subnet</a>	Create the tagged interface unit and security zone for the new VLAN.
<a href="#">Creating your new traffic flows</a>	Create the new traffic flows to allow inbound pinging and SSH.
<a href="#">Confirming the output and committing the changes</a>	Check the output to confirm what will be committed to the active configuration.

## Performing vSRX Virtual Firewall Advanced Tasks in IBM Cloud

### IN THIS SECTION

- [Working with Firewalls | 643](#)
- [Zone Policies | 644](#)
- [Firewall Filters | 645](#)
- [Working with sNAT | 645](#)
- [Working with Failover | 645](#)
- [Working with Routing | 647](#)
- [Working with VPN | 648](#)
- [Securing the Host Operating System | 654](#)
- [Configuring the Management Interfaces | 656](#)

### Working with Firewalls

The IBM Cloud™ Juniper vSRX Virtual Firewall uses the concept of security zones, where each vSRX Virtual Firewall interface is mapped to a "zone" for handling stateful firewalls. Stateless firewalls are controlled by firewall filters.

Policies are used to allow and block traffic between these defined zones, and the rules defined here are stateful.

In the IBM Cloud, a vSRX Virtual Firewall is designed to have four different security zones:

Zone	Standalone Interface	HA Interface
SL-Private (untagged)	ge-0/0/0.0 or ae0.0	reth0.0
SL-Public (untagged)	ge-0/0/1.0 or ae1.0	reth1.1
Customer-Private (tagged)	ge-0/0/0.1 or ae0.1	reth2.1
Customer-Public (tagged)	ge-0/0/1.1 or ae1.1	reth3.1

## Zone Policies

Following are some of the attributes that can be defined in your policies:

- Source addresses
- Destination addresses
- Applications
- Action (permit/deny/reject/count/log)

Since this is a stateful operation, there is no need to allow return packets (in this case, the echo replies).

To configure a stateful firewall, follow these steps:

1. Create security zones and assign the respective interfaces:

Standalone scenario:

```
set security zones security-zone CUSTOMER-PRIVATE interfaces ge-0/0/0.1
```

```
set security zones security-zone CUSTOMER-PUBLIC interfaces ge-0/0/1.1
```

High Availability scenario:

```
set security zones security-zone CUSTOMER-PRIVATE interfaces reth2.1
```

```
set security zones security-zone CUSTOMER-PUBLIC interfaces reth2.1
```

2. Define the policy and rules between two different zones.

The following example illustrates pinging traffic from the zone Customer-Private to Customer-Public:

```
set security policies from-zone CUSTOMER-PRIVATE to-zone CUSTOMER-PUBLIC policy
```

```
set security policies from-zone CUSTOMER-PRIVATE to-zone CUSTOMER-PUBLIC policy
```

3. Use the following commands to allow traffic that is directed to the vSRX Virtual Firewall:

- Standalone scenario:

```
set security zones security-zone CUSTOMER-PRIVATE interfaces ge-0/0/0.0 host-inbound-traffic system-services all
```

- High Availability scenario:

```
set security zones security-zone CUSTOMER-PRIVATE interfaces reth2.0 host-inbound-traffic system-services all
```

4. To allow protocols, such as OSPF or BGP, use the following command:

- Standalone scenario:  
`set security zones security-zone trust interfaces ge-0/0/0.0 host-inbound-traffic protocols all`
- High Availability scenario:  
`set security zones security-zone trust interfaces reth2.0 host-inbound-traffic protocols all`

## Firewall Filters

By default the IBM Cloud™ Juniper vSRX Virtual Firewall allows ping, SSH, and HTTPS to itself and drops all other traffic by applying the PROTECT-IN filter to the lo interface.

To configure a new stateless firewall, follow these steps:

1. Create the firewall filter and term (the following filter allows only ICMP and drops all other traffic)

```
set firewall filter ALLOW-PING term ICMP from protocol icmp
```

```
set firewall filter ALLOW-PING term ICMP then accept
```

2. Apply the filter rule to the interface (the following command applies the filter to all private network traffic)

```
set interfaces ge-0/0/0 unit 0 family inet filter input ALLOW-PING
```

## Working with sNAT

You can refer a sample configuration for sNAT on a vSRX Virtual Firewall appliance, where a private node routed behind the Gateway can communicate with the outside world at [Working with sNAT](#)

To configure NAT for the IBM Cloud™ Juniper vSRX Virtual Firewall, see [Network Address Translation User Guide](#) on the Juniper website.

## Working with Failover

You can initiate failover from your primary IBM Cloud™ Juniper vSRX Virtual Firewall to a backup device, so that all control and data plane traffic is routed through the secondary gateway device after failover.

**NOTE:** This section is only applicable if your Juniper vSRX Virtual Firewall gateway devices are provisioned in High-Availability mode.

Perform the following procedure:

1. Login to your primary vSRX Virtual Firewall gateway device.

2. Enter CLI mode by running the command `cli` at the console prompt. When you enter CLI mode, the console displays the node role, either primary or secondary.
3. On the primary vSRX Virtual Firewall gateway device, run the command:

**show chassis cluster status**

```
Monitor Failure codes:
  CS Cold Sync monitoring      FL Fabric Connection monitoring
  GR GRES monitoring          HW Hardware monitoring
  IF Interface monitoring      IP IP monitoring
  LB Loopback monitoring       MB Mbuf monitoring
  NH Nexthop monitoring        NP NPC monitoring
  SP SPU monitoring            SM Schedule monitoring
  CF Config Sync monitoring

Cluster ID: 2
Node  Priority Status          Preempt Manual      Monitor-failures

Redundancy group: 0 , Failover count: 1
node0 100    primary      no    no    None
node1 1      secondary   no    no    None
Redundancy group: 1 , Failover count: 1
node0 100    primary      yes   no    None
node1 1      secondary   yes   no    None

{primary:node0}
```

Ensure that, for both redundancy groups, the same node is set as primary. It is possible for different nodes to be set as the primary role in different redundancy groups.

**NOTE:** The vSRX Virtual Firewall, by default, sets Preempt to yes for Redundancy group 1, and no for Redundancy group 0. Refer to this link to learn more about pre-emption and failover behavior.

4. Initiate failover by running the following command in the console prompt:

```
request chassis cluster failover redundancy-group <redundancy group number> node <node number>
```

Select the appropriate redundancy group number and node number from the output of the command in step two. To failover both redundancy groups, execute the previous command twice, one for each group.

5. After failover is complete, verify the console output. It should now be listed as secondary.
6. Login to the other vSRX Virtual Firewall gateway of your pair. Enter into CLI mode by again executing the command `cli` and then verify that the console output shows as primary.

**TIP:** When you enter CLI mode in your Juniper vSRX Virtual Firewall gateway device, the output will show as primary from the control plane perspective. Always check the `show chassis cluster status` output to determine which gateway device is primary from data plane perspective. Refer to [vSRX Virtual Firewall Default Configuration](#) to learn more about redundancy groups, as well as the control and data planes.

## Working with Routing

The IBM Cloud™ Juniper vSRX Virtual Firewall is based on JunOS, giving you access to the full Juniper routing stack.

- **Static routing**—To configure static routes, run the following commands:

Setting a default route—`set routing-options static route 0/0 next-hop <Gateway IP>`

- **Creating a static route**—Run the `set routing-options static route <PREFIX/MASK> next-hop <Gateway IP>`
- **Basic OSPF routing**—To setup basic OSPF routing, only using area 0, run the following commands using md5 authentication using the `set protocols ospf area 0 interface ge-0/0/1.0 authentication md5 0 key <key>` command.
- **Basic BGP routing**
  - To setup basic BGP routing, first define the local AS by running the `set routing-options autonomous-system 65001` command.
  - Then configure the BGP neighbor and its session attributes:

```
set protocols bgp group CUSTOMER local-address 10.1.1.1
```

```
set protocols bgp group CUSTOMER family inet unicast
```

```
set protocols bgp group CUSTOMER family inet6 unicast
```

```
set protocols bgp group CUSTOMER peer-as 65002
```

```
set protocols bgp group CUSTOMER neighbor 2.2.2.2
```

In this example, BGP is configured for the following:

- To use source IP address of 10.1.1.1 to establish the session



- To negotiate both ipv4 and ipv6 unicast families
- To peer with a neighbor that belongs to AS 65002
- Peer neighbor IP 10.2.2.2

For more configurations, see [Junos OS Documentation](#)

## Working with VPN

### IN THIS SECTION

- [Sample configuration for Site A \(Dallas\): | 648](#)
- [Sample configuration for Site B \(London\): | 651](#)
- [Performance Consideration | 653](#)

This topic details a sample configuration for a Route based VPN between two sites. In this sample configuration Server 1 (Site A) can communicate with Server 2 (Site B), and each site utilizes two phase IPSEC authentication. For more information see [Working with VPN](#) and

### Sample configuration for Site A (Dallas):

```
# show security address-book global address Network-A
10.84.237.200/29;
[edit]
# show security address-book global address Network-B
10.45.53.48/29;
# show security ike
proposal IKE-PROP {
    authentication-method pre-shared-keys;
    dh-group group5;
    authentication-algorithm sha1;
    encryption-algorithm aes-128-cbc;
    lifetime-seconds 3600;
}
policy IKE-POL {
    mode main;
    proposals IKE-PROP;
    pre-shared-key ascii-text "$9$ewkMLNs2aikPdbkP5Q9CKM8"; ## SECRET-DATA
```

```
}
gateway IKE-GW {
    ike-policy IKE-POL;
    address 10.158.100.100;
    external-interface ge-0/0/1.0;
}
#show security ipsec
proposal IPSEC-PROP {
    protocol esp;
    authentication-algorithm hmac-sha1-96;
    encryption-algorithm aes-128-cbc;
    lifetime-seconds 3600;
}
policy IPSEC-POL {
    perfect-forward-secrecy {
        keys group5;
    }
    proposals IPSEC-PROP;
}
vpn IPSEC-VPN {
    bind-interface st0.1;
    vpn-monitor;
    ike {
        gateway IKE-GW;
        ipsec-policy IPSEC-POL;
    }
    establish-tunnels immediately;
}
#show interfaces
ge-0/0/0 {
    description PRIVATE_VLANS;
    flexible-vlan-tagging;
    native-vlan-id 1121;
    unit 0 {
        vlan-id 1121;
        family inet {
            address 10.184.108.158/26;
        }
    }
    unit 10 {
        vlan-id 1811;
        family inet {
            address 10.184.237.201/29;
        }
    }
}
```

```
    }
  }
  unit 20 {
    vlan-id 1812;
    family inet {
      address 10.185.48.9/29;
    }
  }
}
st0 {
  unit 1 {
    family inet {
      address 10.169.200.0/31;
    }
  }
}
#show security policies
from-zone CUSTOMER-PRIVATE to-zone VPN {
  policy Custprivate-to-VPN {
    match {
      source-address any;
      destination-address Network-B;
      application any;
    }
    then {
      permit;
    }
  }
}
from-zone VPN to-zone CUSTOMER-PRIVATE {
  policy VPN-to-Custprivate {
    match {
      source-address Network-B;
      destination-address any;
      application any;
    }
    then {
      permit;
    }
  }
}
```

**Sample configuration for Site B (London):**

```
# show interfaces
ge-0/0/0 {
  description PRIVATE_VLANS;
  flexible-vlan-tagging;
  native-vlan-id 822;
  unit 0 {
    vlan-id 822;
    family inet {
      address 10.45.165.140/26;
    }
  }
  unit 10 {
    vlan-id 821;
    family inet {
      address 10.45.53.49/29;
    }
  }
}
st0 {
  unit 1 {
    family inet {
      address 10.169.200.1/31;
    }
  }
}
#show security ike
proposal IKE-PROP {
  authentication-method pre-shared-keys;
  dh-group group5;
  authentication-algorithm sha1;
  encryption-algorithm aes-128-cbc;
  lifetime-seconds 3600;
}
policy IKE-POL {
  mode main;
  proposals IKE-PROP;
  pre-shared-key ascii-text "$9$H.fz9A0hSe36SevW-dk.P"; ## SECRET-DATA
}
gateway IKE-GW {
  ike-policy IKE-POL;
  address 10.169.100.100;
```

```

    external-interface ge-0/0/1.0;
}
# show security ipsec
proposal IPSEC-PROP {
    protocol esp;
    authentication-algorithm hmac-sha1-96;
    encryption-algorithm aes-128-cbc;
    lifetime-seconds 3600;
}
policy IPSEC-POL {
    perfect-forward-secrecy {
        keys group5;
    }
    proposals IPSEC-PROP;
}
vpn IPSEC-VPN {
    bind-interface st0.1;
    vpn-monitor;
    ike {
        gateway IKE-GW;
        ipsec-policy IPSEC-POL;
    }
    establish-tunnels immediately;
}
#show security zone security-zone CUSTOMER_PRIVATE
security-zone CUSTOMER-PRIVATE {
    interfaces {
        ge-0/0/0.10 {
            host-inbound-traffic {
                system-services {
                    all;
                }
            }
        }
    }
}
security-zone VPN {
    interfaces {
        st0.1;
    }
}
#show security policies from-zone CUSTOMER-PRIVATE to-zone VPN
policy Custprivate-to-VPN {

```

```

    match {
        source-address any;
        destination-address Network-A;
        application any;
    }
    then {
        permit;
    }
}
#show security zones security-zone VPN
interfaces {
    st0.1;
}
#show security policies from-zone VPN to-zone CUSTOMER-PRIVATE
policy VPN-to-Custprivate {
    match {
        source-address Network-A;
        destination-address any;
        application any;
    }
    then {
        permit;
    }
}
}

```

### Performance Consideration

In order to achieve the best IPSEC VPN performance, use AES-GCM as the encryption algorithm for both IKE and IPSEC proposals.

For example:

```
set security ike proposal IKE-PROP encryption-algorithm aes-128-gcm
```

```
set security ipsec proposal IPSEC-PROP encryption-algorithm aes-128-gcm
```

With AES-GCM as the encryption algorithm, you don't need to specify the authentication algorithm in the same proposal. AES-GCM provides both encryption and authentication.

For more information on VPN configurations, see [IPsec VPN User Guide for Security Devices](#) and [Example: Configuring a Route-Based VPN](#)

## Securing the Host Operating System

### IN THIS SECTION

- [SSH Access | 654](#)
- [Firewalls | 655](#)

The IBM Cloud™ Juniper vSRX Virtual Firewall runs as a Virtual Machine on a bare-metal server installed with Ubuntu and KVM. To secure the host OS, you should ensure that no other critical services are hosted on the same OS.

### SSH Access

The IBM Cloud™ Juniper vSRX Virtual Firewall can be deployed with public and private network access or private network access only. By default, password based SSH access to the public IP of the host OS will be disabled on new provisions and OS reloads. Access to the host can be achieved through the private IP address. Alternatively, key based authentication can be used to access the public IP. To do so, specify the public SSH key when placing a new Gateway order.

Some existing deployments of the IBM Cloud™ Juniper vSRX Virtual Firewall may allow password based SSH access to the public IP of the host OS. For these deployments, you can manually disable password based SSH access to the public IP of the OS by following these steps:

#### 1. Modify `/etc/ssh/sshd_config`

- Ensure the following values are set.

```
ChallengeResponseAuthentication no
PasswordAuthentication no
```

- Add the following filter rules to the end of the file.

```
Match Address 10.0.0.0/8
    Password Authentication yes
```

#### 2. Restart the SSH service using the command `/usr/sbin/service ssh restart`.

The procedure above ensures addresses in the private infrastructure network 10.0.0.0/8 subnet are allowed SSH access. This access is needed for actions such as: OS reloads, Cluster rebuilding, Version upgrades.

## Firewalls

Implementing an Ubuntu firewall (UFW, Iptables, and so on) without required rules can cause the vSRX Virtual Firewall HA cluster to be disabled. The vSRX Virtual Firewall solution depends on heartbeat communication between the primary and secondary nodes. If the firewall rules do not allow communication between the nodes, then cluster communication will be lost.

The vSRX Virtual Firewall architecture influences the firewall rules discussed below. Details on the two architectures can be found in [vSRX default configuration](#).

For vSRX Virtual Firewall version 18.4 HA deployments running with the legacy architecture, the following rules are required to allow cluster communication for UFW:

1. To allow protocol 47 (used for heartbeat communication) in /etc/ufw/before.rules:

```
-A ufw-before-input -p 47 -j ACCEPT
```

2. To allow private network communication:

```
ufw allow in from 10.0.0.0/8 to 10.0.0.0/8
```

3. To enable UFW:

```
ufw enable
```

For vSRX Virtual Firewall versions running with the newer architecture, the firewall rules must allow multicast communication.

**NOTE:** In some cases, troubleshooting operations may require disabling the firewall for access to public repositories. In these cases, you should work with IBM Support to understand how to proceed.

Most Gateway actions require SSH access to the private 10.0.0.0/8 subnet for the host OS and the vSRX Virtual Firewall. Blocking this access with a firewall can cause the following actions to fail: OS reloads, Cluster rebuilding, and Version upgrades

As a result, if SSH access is disabled for the 10.0.0.0/8 subnet, you must re-enable it prior to executing any of these actions.



## Configuring the Management Interfaces

The IBM Cloud™ Juniper vSRX Virtual Firewall nodes provide built-in management interfaces ("fxp0") that are not configured by default. When configured, these private interfaces can be used to communicate with the individual node, which might be useful in a high availability cluster for monitoring the status of the secondary node over SSH, ping, SNMP, and so on. Since the private IP for the vSRX Virtual Firewall floats to the primary node, it is not possible to directly access the secondary node.

Configuration of the fxp0 interface requires IPs in a subnet that is attached to the private transit VLAN for the gateway. Although the primary subnet that comes with the gateway has IPs that might be available, it is not recommended for this use. This is because the primary subnet is reserved for the gateway provisioning infrastructure, and IP collisions could occur if additional gateways are deployed in the same pod.

You can allocate a secondary subnet for the private transit VLAN, and use IPs from this subnet to configure fxp0 and the host bridge interface for PING and SSH access. To do so, perform the following procedure:

1. [Order a portable private subnet](#) and assign it to the vSRX Virtual Firewall private transit VLAN. You can find the private transit VLAN on the gateway details page.

**NOTE:** Ensure the subnet includes at least 8 addresses in order to support 2 IPs for the host bridge interfaces, and 2 IPs for the vSRX Virtual Firewall fxp0 interfaces.

2. Configure the host br0:0 bridge interfaces using 2 IPs from the new subnet. For example:

On Ubuntu host 0: `ifconfig br0:0 10.177.75.140 netmask 255.255.255.248`

On Ubuntu host 1: `ifconfig br0:0 10.177.75.141 netmask 255.255.255.248`

3. Persist the bridge interface configurations across reboots by modifying `/etc/network/interfaces` on each Ubuntu host. For example:

```
auto br0:0
iface br0:0 inet static
address 10.177.75.140
netmask 255.255.255.248
post-up /sbin/ifconfig br0:0 10.177.75.140 netmask 255.255.255.248
```

4. Assign the 2 IP's to the vSRX Virtual Firewall fxp0 interface and create backup router configurations for access to the secondary node's fxp0 interface:

```
set groups node0 interfaces fxp0 unit 0 family inet address 10.177.75.138/29
set groups node1 interfaces fxp0 unit 0 family inet address 10.177.75.139/29
```

```
set groups node0 system backup-router 10.177.75.137 destination [ 0.0.0.0/1 128.0.0.0/1 ]
set groups node1 system backup-router 10.177.75.137 destination [ 0.0.0.0/1 128.0.0.0/1 ]
```

**NOTE:** Additional information on configuring the backup router can be found in this Juniper article at: [KB17161](#).

5. Create a static route to the subnet. For example:

```
set routing-options static route 10.177.75.136/29 next-hop 10.177.75.137
```

6. Create firewall filters to allow PING and SSH to the fxp0 management interfaces:

```
set firewall filter PROTECT-IN term PING from destination-address 10.177.75.136/29
```

```
set firewall filter PROTECT-IN term SSH from destination-address 10.177.75.136/29
```

## Upgrading the vSRX Virtual Firewall in IBM Cloud

### IN THIS SECTION

- [Upgrading | 657](#)
- [General Upgrade Considerations | 660](#)
- [Upgrading using OS Reload | 663](#)
- [Rollback Options | 664](#)
- [Unsupported Upgrades | 664](#)

## Upgrading

There are several methods and considerations that you must understand before upgrading your IBM Cloud® Juniper vSRX Virtual Firewall:

- vSRX Virtual Firewall version level
- Bare-metal server processor model
- Bandwidth: 1G versus 10G
- Stand-alone or High Availability (HA)

Using these factors, the following table lists whether you can use the OS reload option to upgrade your vSRX Virtual Firewall. The table also describes whether rollback is supported for the upgrade. Additional considerations include whether you need a manual vSRX Virtual Firewall configuration migration to complete the upgrade.

Reference the following table to determine if you can upgrade your vSRX Virtual Firewall using OS reload. For more information, see [General upgrade considerations](#).

For more information on the vSRX Virtual Firewall versions listed below, see [IBM Cloud Juniper vSRX supported versions](#).

Current vSRX Virtual Firewall Version	Processor Model and Speed	Stand-Alone or HA	Upgrade method	Rollback supported
15.1	1270v6 (All 1G deployments)	Stand-alone and HA	Not Supported	N/A
15.1	All 10G Deployments	Stand-alone and HA	<a href="#">Upgrading using OS Reload</a>	Stand-alone: No HA: <ul style="list-style-type: none"> <li>Manual (not automated) rollbacks are allowed after the first server completes the OS reload.</li> <li>Rollbacks are not allowed after the second server completes its OS reload.</li> </ul>
18.4	1270v6 (Some 1G Deployments)	Stand-alone and HA	Not Supported	N/A
18.4	4210 (Some 1G Deployments)	Stand-alone	<a href="#">Upgrading using OS Reload</a>	No

*(Continued)*

Current vSRX Virtual Firewall Version	Processor Model and Speed	Stand-Alone or HA	Upgrade method	Rollback supported
18.4	4210 (Some 1G Deployments)	HA	<a href="#">Upgrading using OS Reload</a>	<ul style="list-style-type: none"> <li>• Yes – If you are running version 18.4 with new architecture, manual (not automated) rollbacks are allowed after the first server completes the OS reload. For more information, see <a href="#">Rollback Options</a>.</li> <li>• No – If you are running version 18.4 without new architecture.</li> </ul>
18.4	All 10G Deployments	Stand-alone	<a href="#">Upgrading using OS Reload</a>	No

*(Continued)*

Current vSRX Virtual Firewall Version	Processor Model and Speed	Stand-Alone or HA	Upgrade method	Rollback supported
18.4	All 10G Deployments	HA	<a href="#">Upgrading using OS Reload</a>	<ul style="list-style-type: none"> <li>• Yes – If you are running version 18.4 with new architecture, manual (not automated) rollbacks are allowed after the first server completes the OS reload. For more information, see <a href="#">Rollback Options</a>.</li> <li>• No – If you are running version 18.4 without new architecture.</li> </ul>
19.4 and newer	All 1G and 10G Deployments	Stand-alone and HA	<a href="#">Upgrading using OS Reload</a>	Yes – Manual (not automated) rollbacks are allowed after the first server completes the OS reload. For more information, see <a href="#">Rollback Options</a> .

## General Upgrade Considerations

Before you perform a vSRX Virtual Firewall upgrade, be aware of the following considerations:

- You might experience network disruptions when upgrading your vSRX Virtual Firewall version. To avoid disruptions, perform the upgrade during a maintenance window that supports potential network downtime. Failover is not available until the upgrade completes, and can take several hours. For High Availability (HA) environments, your vSRX Virtual Firewall configuration settings are migrated; however, it is recommended to export your settings before the upgrade.

- For a stand-alone environment, the previous configuration is not restored, so you should export and import your configuration. For more information, see Importing and exporting a vSRX Virtual Firewall configuration.
- For a successful reload on a HA vSRX Virtual Firewall, the root password for the provisioned vSRX Virtual Firewall gateway must match the root password that is defined in the vSRX Virtual Firewall portal. In addition, you must enable root SSH login to the vSRX Virtual Firewall Private IP.

**NOTE:** You defined the password in the portal when you provisioned your gateway. This might not match the current gateway password. If the password was changed after provisioning, then use SSH to connect to the vSRX Virtual Firewall gateway and change the root password to match. The Readiness Check fails if there is a password mismatch.

- Do not modify the vSRX Virtual Firewall configuration during an OS reload. The upgrade process captures a snapshot of the current vSRX Virtual Firewall cluster configuration at the beginning of the process. Therefore, modifying the vSRX Virtual Firewall configuration during the upgrade process can result in a failure, or unpredictable results. For example, automated software agents attempting to modify one or both vSRX Virtual Firewall nodes. Configuration changes can corrupt the OS reload process. Additionally, these configuration changes are not preserved if a rollback is initiated.
- Before performing an OS reload upgrade on an HA cluster, run the command `show chassis cluster status`. The nodes should be clustered with one node that is listed as the primary and the other as secondary. Ensure that there are no monitor failures. If the cluster is not healthy prior to the upgrade, then the upgrade can fail, causing an extended traffic outage.

Example of a healthy cluster:

```

root@asloma-19-10g-ha1-vsrx-vSRX-Node0> show chassis cluster status
Monitor Failure codes:
  CS Cold Sync monitoring      FL Fabric Connection monitoring
  GR GRES monitoring          HW Hardware monitoring
  IF Interface monitoring      IP IP monitoring
  LB Loopback monitoring      MB Mbuf monitoring
  NH Nextthop monitoring      NP NPC monitoring
  SP SPU monitoring           SM Schedule monitoring
  CF Config Sync monitoring    RE Relinquish monitoring
  IS IRQ storm

Cluster ID: 2
Node   Priority Status          Preempt Manual  Monitor-failures

Redundancy group: 0 , Failover count: 1

```

```
node0 100    primary          no    no    None
node1 1      secondary       no    no    None
```

```
Redundancy group: 1 , Failover count: 1
```

```
node0 100    primary          no    no    None
node1 1      secondary       no    no    None
```

```
{primary:node0}
```

Example of an unhealthy cluster with monitor failures:

```
root@asloma-tc11-15-10g-pubpriv-ha1-vsrx-vSRX-Node1> show chassis cluster status
```

```
Monitor Failure codes:
```

```
CS Cold Sync monitoring      FL Fabric Connection monitoring
GR GRES monitoring          HW Hardware monitoring
IF Interface monitoring      IP IP monitoring
LB Loopback monitoring      MB Mbuf monitoring
NH Nexthop monitoring       NP NPC monitoring
SP SPU monitoring           SM Schedule monitoring
CF Config Sync monitoring
```

```
Cluster ID: 3
```

```
Node  Priority Status          Preempt Manual  Monitor-failures
```

```
Redundancy group: 0 , Failover count: 1
```

```
node0 0      lost          n/a    n/a    n/a
node1 1      primary      no     no     None
```

```
Redundancy group: 1 , Failover count: 1
```

```
node0 0      lost          n/a    n/a    n/a
node1 0      primary      no     no     CS
```

```
{primary:node1}
```

- If your IBM Cloud account has multiple vSRX Virtual Firewall gateway instances in the same pod, make sure that only one gateway is upgraded at a time. Upgrading more than one vSRX Virtual Firewall at a time can result in IP collisions, disrupt the upgrade process, and potentially cause failures.
- For HA clusters, the upgrade process requires you to disable the vSRX Virtual Firewall Chassis Cluster preemption flag for Redundancy Group 1. Therefore, after the upgrade completes, the flag is disabled, but you can enable again. Run show chassis cluster status to view the preempt setting.

## Upgrading using OS Reload

### IN THIS SECTION

- [vSRX Virtual Firewall Migration Configuration Considerations](#) | 663

To upgrade your vSRX Virtual Firewall using OS reload, perform the following procedure.

1. Standalone environment only: See [Exporting part of the vSRX configuration](#).
2. Access the gateway details page, see [Viewing gateway appliance details](#).
3. Run a readiness check for “OS reload”. See [Checking vSRX readiness](#) and address any errors that are found.
4. Perform an OS reload for each bare metal server. See [Performing an OS reload](#).

**NOTE:** When upgrading an HA cluster, the process will power off the node not undergoing the OS reload at the end of the upgrade process. This will transition the cluster’s primary node and any active network traffic to the newly upgraded one. Once the OS reload completes for the first node in the cluster, it is critical that the second node be left unpowered until the OS reload to upgrade that node is submitted and running. Powering the node on prior to the OS reload will cause the cluster to run with mismatched vSRX Virtual Firewall versions, potentially leading to a “split-brain” scenario where each node tries to claim primary ownership. This generally results in an outage. After the OS reload of the first node, the gateway will transition to “Upgrade Active” status.

5. Standalone environment only: Import the vSRX Virtual Firewall configuration and migrate the settings to the new architecture if necessary.

### vSRX Virtual Firewall Migration Configuration Considerations

For a High Availability environment, the upgrade restores the previous vSRX Virtual Firewall configuration. No further steps are needed.

For a Standalone environment, the upgrade does not restore the previous configuration, so you should export and import your configuration. See [Importing and exporting a vSRX Configuration](#) for more information.



Additionally, when migrating from an older version, such as 15.1, your interface mappings may have changed. This requires some modifications to the vSRX Virtual Firewall configuration after the import. See [Migrating 1G vSRX standalone configurations](#) for more information.

## Rollback Options

In the standalone environment a rollback is not supported.

In the high availability environment that is upgrading from vSRX Virtual Firewall version, a rollback is supported only after the first node has been OS Reloaded and before the second node has been OS Reloaded. The Gateway will be in an “Upgrade Active” state at this point. The following steps should be followed to rollback the first node to the previous version.

**NOTE:** Please be aware that a traffic disruption will occur while waiting for the secondary node to power on and for the traffic to failover to this node.

1. Power off the vSRX Virtual Firewall on the node being rolled-back (primary node) using the command `virsh shutdown <domain>`. Wait for the node to be fully powered off before proceeding.
2. Power up the vSRX Virtual Firewall on the node that has not been rolled-back using the command `virsh start <domain>`. Doing so will return the primary node back to the original vSRX Virtual Firewall version.

Before restoring the original vSRX Virtual Firewall image, rename the vSRX Virtual Firewall qcow2 file in `/var/lib/libvirt/images/vSRXvM2/vSRX_Image.qcow2.backup` to `/var/lib/libvirt/images/vSRXvM2/vSRX_Image.qcow2` so that `virsh` detects the original image.

3. Run the OS reload readiness checks, see [Checking vSRX readiness](#) if necessary, and resolve any issues.
4. Perform an OS reload on the host you want to rollback to return it to the original vSRX Virtual Firewall version.

The cluster will now be running with its original configuration.

## Unsupported Upgrades

Early deployments of 1G vSRX Virtual Firewall 15.1 and 18.4 gateways used a networking design based on Linux Bridging. Newer 1G deployments use a networking design based on SR-IOV. For more information, see [Understanding the vSRX default configuration](#).

Early 1G deployments generally used an Intel 1270v6 4-Core, Sky-Lake-based processor. This processor does not support SR-IOV. Newer vSRX Virtual Firewall versions, such as 19.4, require the SR-IOV

networking design. Therefore, vSRX Virtual Firewall version upgrades are not supported for deployments based on this 1270v6 processor.

To upgrade to a newer vSRX Virtual Firewall version, such as 19.4, you must place a new vSRX Virtual Firewall order. After completion, you can migrate the configuration from the old design to the new, but you must also apply some manual configuration changes to the new vSRX Virtual Firewall. For more information, see [Migrating Legacy Configurations to the Current vSRX Architecture](#).

# Managing vSRX Virtual Firewall in IBM Cloud

## IN THIS CHAPTER

- [vSRX Virtual Firewall Configuration and Management Tools | 666](#)
- [Managing Security Policies for Virtual Machines Using Junos Space Security Director | 667](#)

## vSRX Virtual Firewall Configuration and Management Tools

### SUMMARY

This topic provides an overview of the various tools available to configure and manage a vSRX Virtual Firewall VM once it has been successfully deployed.

### IN THIS SECTION

- [Understanding the Junos OS CLI and Junos Scripts | 666](#)
- [Understanding the J-Web Interface | 667](#)
- [Understanding Junos Space Security Director | 667](#)

## Understanding the Junos OS CLI and Junos Scripts

Junos OS CLI is a Juniper Networks specific command shell that runs on top of a UNIX-based operating system kernel.

Built into Junos OS, Junos script automation is an onboard toolset available on all Junos OS platforms, including routers, switches, and security devices running Junos OS (such as a vSRX Virtual Firewall instance).

You can use the Junos OS CLI and the Junos OS scripts to configure, manage, administer, and troubleshoot vSRX Virtual Firewall.

## Understanding the J-Web Interface

The *J-Web* interface allows you to monitor, configure, troubleshoot, and manage vSRX Virtual Firewall instances by means of a Web browser. J-Web provides access to all the configuration statements supported by the vSRX Virtual Firewall instance.

## Understanding Junos Space Security Director

As one of the Junos Space Network Management Platform applications, Junos Space Security Director helps organizations improve the reach, ease, and accuracy of security policy administration with a scalable, GUI-based management tool. Security Director automates security provisioning of a vSRX Virtual Firewall instance through one centralized Web-based interface to help administrators manage all phases of the security policy life cycle more quickly and intuitively, from policy creation to remediation.

### RELATED DOCUMENTATION

---

[CLI User Interface Overview](#)

---

[J-Web Overview](#)

---

[Security Director](#)

---

[Mastering Junos Automation Programming](#)

---

[Spotlight Secure Threat Intelligence](#)

## Managing Security Policies for Virtual Machines Using Junos Space Security Director

### SUMMARY

This topic provides you an overview of how you can manage security policies for VMs using security director.

Security Director is a Junos Space management application designed to enable quick, consistent, and accurate creation, maintenance, and application of network security policies for your security devices, including vSRX Virtual Firewall instances. With Security Director, you can configure security-related policy management including IPsec VPNs, firewall policies, NAT policies, IPS policies, and Content

Security policies, and push the configurations to your security devices. These configurations use objects such as addresses, services, NAT pools, application signatures, policy profiles, VPN profiles, template definitions, and templates. These objects can be shared across multiple security configurations; shared objects can be created and used across many security policies and devices. You can create these objects prior to creating security configurations.

When you finish creating and verifying your security configurations from Security Director, you can publish these configurations and keep them ready to be pushed to all security devices, including vSRX Virtual Firewall instances, from a single interface.

The Configure tab is the workspace where all of the security configuration happens. You can configure firewall, IPS, NAT, and Content Security policies; assign policies to devices; create and apply policy schedules; create and manage VPNs; and create and manage all the shared objects needed for managing your network security.

## RELATED DOCUMENTATION

| [Security Director](#)

# Monitoring and Troubleshooting

## IN THIS CHAPTER

- [Technical Support | 669](#)

## Technical Support

### SUMMARY

### IN THIS SECTION

- [Getting Help and Support Information | 669](#)

## Getting Help and Support Information

This topic provides you details on getting technical assistance.

If you have problems or questions when using IBM Cloud Gateway Appliance (vSRX Virtual Firewall), you can search for information or ask questions by using [Stack Overflow](#). Or post your question, then tag it with "vSRX Virtual Firewall" and "ibm-cloud".

For any technical assistance, contact IBM customer support team and then IBM team will raise tickets with Juniper JTAC. Do not raise Juniper help desk tickets directly.

For information about opening an IBM Support case, or about support levels and case severities, see [Contacting Support](#).

### RELATED DOCUMENTATION

[Junos OS Documentation](#)

[SRX Firewall Features - User Guides](#)

# 10

PART

## vSRX Virtual Firewall Deployment for OCI

---

[Overview | 671](#)

[Installing vSRX Virtual Firewall in OCI | 676](#)

[vSRX Virtual Firewall Licensing | 693](#)

---

# Overview

## IN THIS CHAPTER

- [Understanding vSRX Virtual Firewall Deployment in Oracle Cloud Infrastructure | 671](#)
- [Requirements for vSRX Virtual Firewall on Oracle Cloud Infrastructure | 673](#)

## Understanding vSRX Virtual Firewall Deployment in Oracle Cloud Infrastructure

### IN THIS SECTION

- [Overview of Oracle VM Architecture | 671](#)
- [vSRX Virtual Firewall with Oracle Cloud Infrastructure | 672](#)
- [OCI Glossary | 672](#)

### Overview of Oracle VM Architecture

This section provides you information on the Oracle VM architecture.

Oracle Cloud Infrastructure (OCI) is a set of complementary cloud services that enable you to build and run a wide range of applications and services in a highly available hosted environment. Oracle Cloud Infrastructure offers high-performance compute capabilities (as physical hardware instances) and storage capacity in a flexible overlay virtual network that is securely accessible from your on-premises network.

Oracle virtual machine (VM) management platform provides a fully equipped environment with all the latest benefits of virtualization technology. Oracle VM platform helps you deploy operating systems and application software within a supported virtualization environment. Oracle VM can support both 1G and 10G physical NICs.

vSRX Virtual Firewall 3.0 VM can be deployed on Oracle VM server running on X86 hardware.



## vSRX Virtual Firewall with Oracle Cloud Infrastructure

vSRX Virtual Firewall 3.0 specifications for deployment in OCI are: vSRX3.0 has one RE, one virtual FPC slot, and one virtual PIC. The virtual Gigabit Ether ports (labeled as “ge-0/0/[0 – (n-1)]”) will be within the one PIC. The index is zero-based. Number n depends on hypervisor. The maximum number of interfaces supported on vSRX Virtual Firewall are 7.

A domain is a configurable set of resources, including memory, virtual CPUs, network devices and disk devices, in which virtual machines run. A user-domain (domU) is granted virtual resources and can be started, stopped and restarted independently of other domains and of the host server itself. vSRX Virtual Firewall as a guest virtualized operating system runs within a domain. Oracle vSRX Virtual Firewall VM guests consume resources that are allocated to the domain by the hypervisor running on the Oracle VM Server. For more information about the Oracle VM Guest Additions, see [Installing and Using the Oracle VM Guest Additions](#).

When a virtual machine is running, it can be accessed through a console, which allows it to be used as a regular operating system. vSRX Virtual Firewall as a guest virtualized operating system runs within a VM.

### SEE ALSO

| [How are Network Functions Separated in Oracle VM](#)

## OCI Glossary

This section defines some common terms used in Oracle Cloud Infrastructure (OCI) configuration. [Table 96 on page 672](#) provides a list of the common terms used in OCI.

**Table 96: OCI VCN Related Terminology**

Term	Description
OCI	Oracle Cloud Infrastructure, which is running Xen Hypervisor.
Oracle VM Server	A managed virtualization environment providing a lightweight, secure, server platform which runs virtual machines, also known as domains.
Oracle VM Manager	Used to manage Oracle VM Servers, virtual machines, and resources. It is comprised of a number of subcomponents, including a web browser-based user interface; and a command line interface (CLI).

**Table 96: OCI VCN Related Terminology (Continued)**

Term	Description
Oracle Compute Shapes	A shape is a resource profile that specifies the number of OCPUs and the amount of memory to be allocated to an instance in Compute Classic.
Port	The network interface on a server. This term is used interchangeably with NIC (Network Interface Card).
VLAN	A method used to virtualize networking at the switch or router for better control over network separation. VLANs are virtual networks that use identifiers to separate traffic into different networks within the switch.
VNIC	Virtual machines are assigned VNICs or virtual network interface cards, which are allocated faux MAC addresses. This allows each virtual machine to connect to a network. The VNICs are bridged interfaces that are connected to a logical network that has the Virtual Machine channel enabled. A VNIC is only ever assigned to a virtual machine. A virtual machine can have as many VNICs as required within the limitations posed by the virtualization method used. For instance, hardware virtualized virtual machines are able to support a limited number of VNICs, while paravirtualized virtual machines can have an unlimited number of VNICs.

## Requirements for vSRX Virtual Firewall on Oracle Cloud Infrastructure

### IN THIS SECTION

- [Minimum System Requirements for OCI | 674](#)
- [vSRX Virtual Firewall Default Settings with OCI | 675](#)
- [Best Practices for Deploying vSRX Virtual Firewall | 675](#)

This topic provides the requirements for deploying vSRX Virtual Firewall instances on Oracle Cloud Infrastructure (OCI).

## Minimum System Requirements for OCI

Table 97 on page 674 lists the minimum system requirements for vSRX Virtual Firewall instances to be deployed on OCI.

**Table 97: Minimum System Requirements for vSRX Virtual Firewall**

Component	Specification and Details
Memory	4 GB
Disk space	16 GB

Oracle pre-defined VM shapes that vSRX Virtual Firewall support are listed below. If you need any other VM shapes, then please contact your Juniper sales representative.

**Table 98: OCI VM Shapes Supported by vSRX Virtual Firewall**

Shape	OCPU	Memory (GB)	Local Disk (TB)	Network Bandwidth	Max VNICs Total: Linux
VM.Standard2.4	4	60	Block Storage only	4.1 Gbps	4
VM.Standard2.8	8	120	Block Storage only	8.2 Gbps	8

Interface Mapping for vSRX Virtual Firewall on OCI: The first network interface is used for the out-of-band management (fxp0) for vSRX Virtual Firewall.

We recommend putting revenue interfaces in routing instances as a best practice to avoid asymmetric traffic/routing, because fxp0 is part of the default (inet.0) table by default. With fxp0 as part of the default routing table, there might be two default routes needed: one for the fxp0 interface for external management access, and the other for the revenue interfaces for traffic access. Putting the revenue interfaces in a separate routing instance avoids this situation of two default routes in a single routing instance.

**NOTE:** Ensure that interfaces belonging to the same security zone are in the same routing instance. See [KB Article - Interface must be in the same routing instance as the other interfaces in the zone.](#)

## vSRX Virtual Firewall Default Settings with OCI

Do not use the `load factory-default` command on a vSRX Virtual Firewall OCI instance. The factory-default configuration removes the OCI preconfiguration. If you must revert to factory default, ensure that you manually reconfigure preconfiguration statements before you commit the configuration; otherwise, you will lose access to the vSRX Virtual Firewall instance. See *Configure vSRX Using the CLI* for preconfiguration details.

## Best Practices for Deploying vSRX Virtual Firewall

Refer the following best practices for deploying vSRX Virtual Firewall:

- Disable the source/destination check for all vSRX Virtual Firewall interfaces.
- Limit public key access permissions to 400 for key pairs.
- Ensure that there are no contradictions between OCI security groups and your vSRX Virtual Firewall configuration.

# Installing vSRX Virtual Firewall in OCI

## IN THIS CHAPTER

- [vSRX Virtual Firewall Deployment in Oracle Cloud Infrastructure | 676](#)
- [Upgrade the Junos OS for vSRX Virtual Firewall Software Release | 692](#)

## vSRX Virtual Firewall Deployment in Oracle Cloud Infrastructure

### IN THIS SECTION

- [Overview | 676](#)
- [Launch vSRX Virtual Firewall Instances in the OCI | 678](#)

The topics in this section help you launch vSRX Virtual Firewall instances in Oracle Cloud Infrastructure.

### Overview

#### IN THIS SECTION

- [Pre-Requisites | 677](#)
- [Example Topology | 677](#)

This topic provides you an overview and pre-requisites to deploy vSRX Virtual Firewall virtual Firewall in Oracle Cloud Infrastructure. vSRX Virtual Firewall provides security and networking services for virtualized private or public Oracle Cloud environments.

Starting in Junos OS Release 20.4R2, vSRX Virtual Firewall 3.0 is available for OCI deployments.

**NOTE:** vSRX Virtual Firewall 3.0 image is not available in the OCI Marketplace. You must download the vSRX Virtual Firewall 3.0 software from [Juniper Support Downloads](#) and upload into an OCI compartment.

### Pre-Requisites

- Ensure you have proper accounts and permissions before you attempt to deploy the vSRX Virtual Firewall in OCI.
- Copy the .oci image to an object storage compartment in your OCI account.

An example file name is junos-vsrx3-x86-64-xxxx.oci. After you purchase the vSRX Virtual Firewall 3.0 software you can download the software from: [Juniper Support](#) page.

**NOTE:** .oci image extensions are built for the vSRX Virtual Firewall images to be deployed in OCI. This is because on OCI, when the qcow2 images are deployed, the default emulation selected for the vNIC is e-1000. The .oci images of the vSRX Virtual Firewall pass the metadata needed for the emulation type to be set to virtIO upon deployment of the vSRX Virtual Firewall which ensure a better throughput.

- Create Virtual Network subnets for your deployment.

For better understanding of Oracle terminologies and their use in vSRX Virtual Firewall 3.0 deployments, see "[Understanding vSRX Virtual Firewall Deployment in Oracle Cloud Infrastructure](#)" on page 671.

### Example Topology

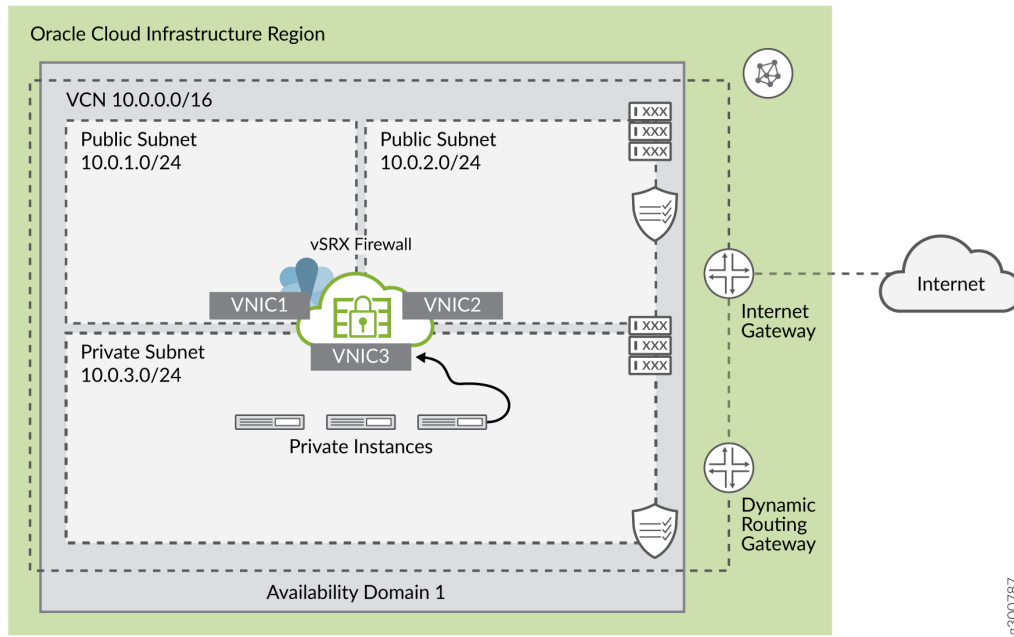
A common cloud configuration includes hosts that you want to grant access to the Internet, but you do not want anyone from outside your cloud to get access to your hosts. You can use vSRX Virtual Firewall in the OCI to NAT traffic inside the OCI from the public Internet.

The diagram shows an example VCN with three subnets:

- Public (10.0.1.0/24), for management interfaces with access to the internet through an internet gateway
- Public (10.0.2.0/24), for revenue (data) interfaces with access to the internet through an internet gateway
- Private (10.0.3.0/24), a private subnet with no access to the internet

The following topology is used as an example for this deployment.

**Figure 148: Example VCN for vSRX Virtual Firewall Deployment in OCI**



## Launch vSRX Virtual Firewall Instances in the OCI

This topic provides details on how you can launch vSRX Virtual Firewall instances in the OCI.

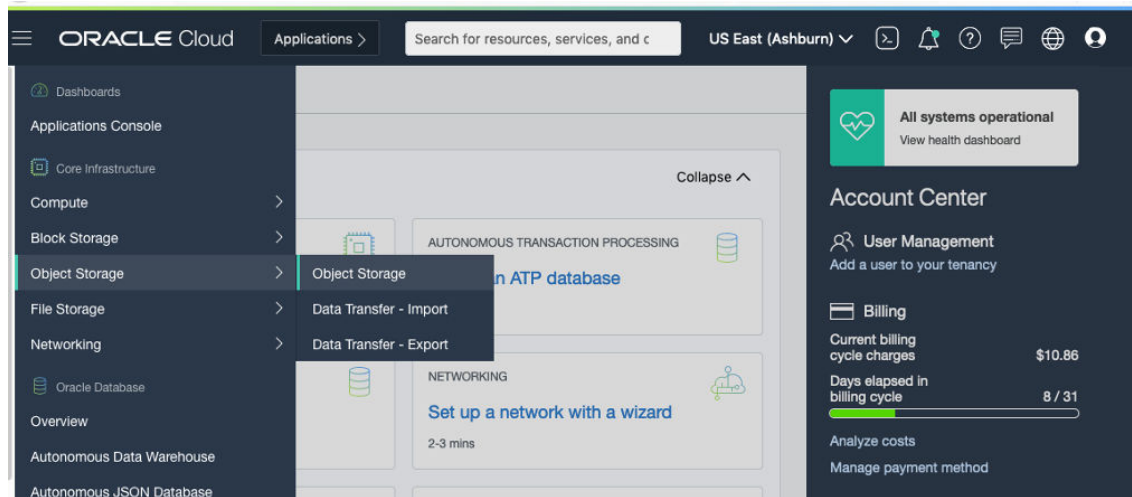
1. Log in to the OCI Management Console. The Console is an intuitive, graphical interface that lets you create and manage your instances, cloud networks, and storage volumes, as well as your users and permissions. After you sign in, the console home page is displayed.
2. Choose a compartment for your resources.

Compartments help you organize and control access to your resources. A compartment is a collection of related resources (such as cloud networks, compute instances, or block volumes) that can be accessed only by those groups that have been given permission by an administrator in your organization. For example, one compartment could contain all the servers and storage volumes that make up the production version of your company's Human Resources system. Only users with permission to that compartment can manage those servers and volumes.

- Open the navigation menu. Under **Core Infrastructure**, go to **Networking** and click **Virtual Cloud Networks**.

- Select the Sandbox compartment (or the compartment designated by your administrator) from the list on the left. If the Sandbox compartment does not exist, you can create. For more information, see [Creating a Compartment](#).
3. Load the .oci onto OCI platform.
- a. From the main menu click **Object Storage**.

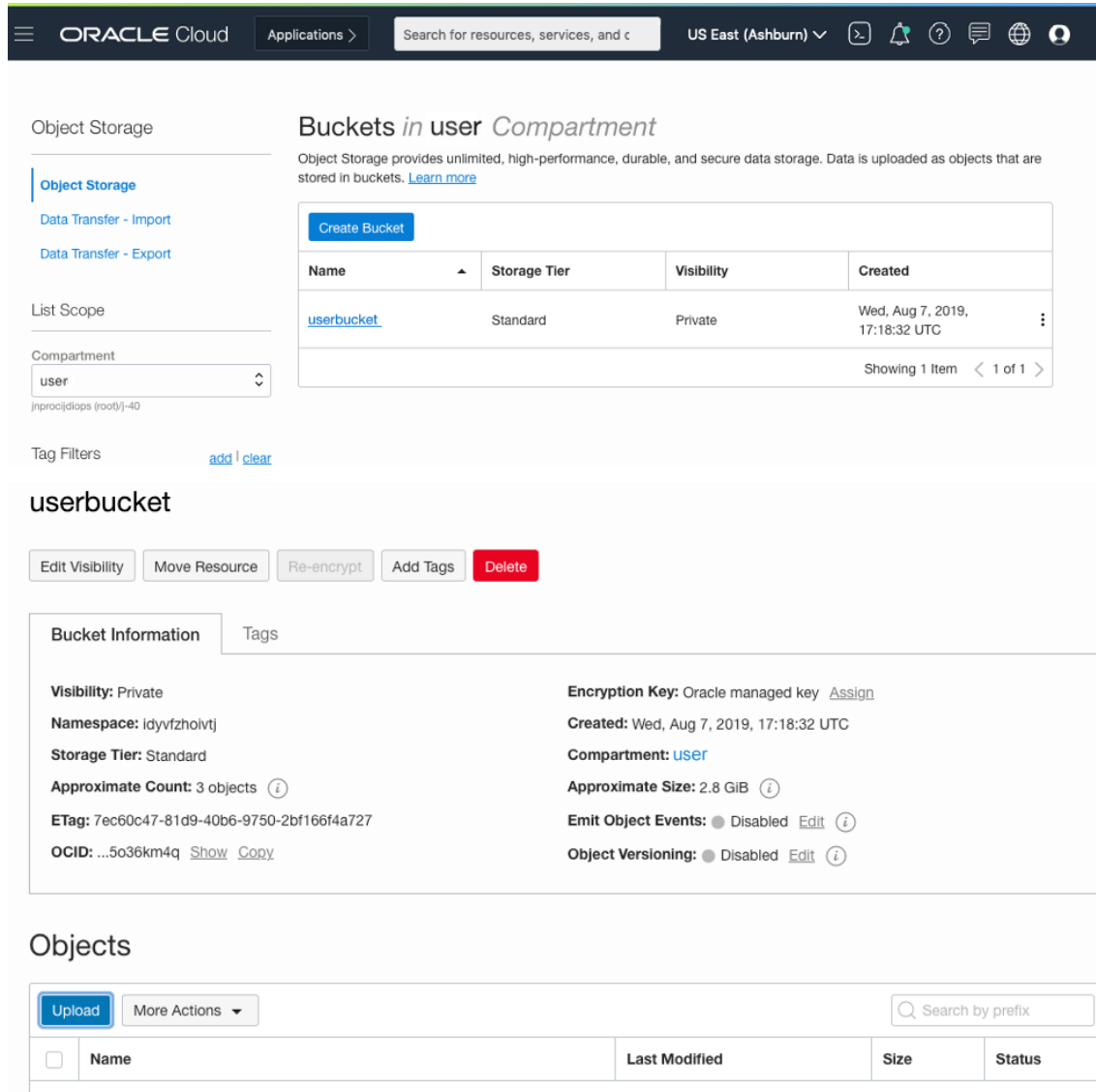
Figure 149: Object Storage



- b. Select the compartment in which you want to create the bucket. If you have a bucket already, click the name of “your bucket”. Or create a bucket.



Figure 150: Create Bucket



c. Then Click **Upload Objects**.

Provide the required information when a pop-up window appears.

Figure 151: Upload Objects

Upload Objects [Help](#)

Object Name Prefix *Optional*

Choose Files from your Computer

Drop files here or [select files](#)

[Show Optional Response Headers and Metadata](#)

View Object Details: After the .oci image is loaded, choose the object right click the object and select **View Object Details**.

Figure 152: View Object Details

Objects

[Upload](#) [More Actions](#)

<input type="checkbox"/>	Name	Last Modified	
<input type="checkbox"/>	user-junos-vsrx3-x86-64-19.4l-20190806_dev_common.0.1257.oci	Wed, Aug 7, 2019, 17:50:49 UTC	View Object Details
<input type="checkbox"/>	nov11-j-junos-vsrx3-x86-64-19.4l-20191110.0.1132.oci	Mon, Nov 11, 2019, 23:54:11 UTC	Download
			Copy
			Restore
			Create Pre-Authenticated Request
			Re-encrypt
			Rename
			Delete

**NOTE:** There will be an URL path for this object as OCI ID, which can be used in the during importing images.

4. Create a virtual cloud network (VCN) with subnets. Multiple subnets within a single VCN network is possible.

You will then launch your instance into one of the subnets of your VCN and connect to it.

**NOTE:** Ensure that the Sandbox compartment (or the compartment designated for you) is selected in the Compartment list on the left.

- a. Open the **Navigation** menu. Under **Core Infrastructure**, go to **Networking** and click **Virtual Cloud Networks**.
- b. Click **Create VCN** and enter the data for VCN Name, Compartment, select an IPv4 VCN CIDR Block, Public Subnet CIDR Block. Accept the defaults for any other fields and click **Create VCN**.

The screenshot shows the Oracle Cloud console interface. The top navigation bar includes the Oracle Cloud logo, an 'Applications >' dropdown, and a search bar. The left-hand navigation menu is expanded to show the 'Networking' section, which is highlighted in blue. Under 'Networking', a sub-menu is open, listing various networking services: Overview, Virtual Cloud Networks (highlighted), Dynamic Routing Gateways, Customer-Premises Equipment, VPN Connections, Load Balancers, FastConnect, IP Management, and DNS Management. The main content area displays the 'Virtual Cloud Networks' page, featuring a 'Create VCN' button and a 'Start VCN Wizard' button. Below these buttons is a table with columns for 'Name' and 'State', showing a single entry named 'uservcn' with a green status indicator.

Figure 153: Create Virtual Cloud Network

Create Virtual Cloud Network [help](#) [cancel](#)

CREATE IN COMPARTMENT  
Salman-Demo

NAME (OPTIONAL)  
DataCenter-1

CREATE VIRTUAL CLOUD NETWORK ONLY  
 CREATE VIRTUAL CLOUD NETWORK PLUS RELATED RESOURCES

Creates a Virtual Cloud Network only. You'll still need to set up at least one Subnet, Gateway, and Route Rule to have a working Virtual Cloud Network.

CIDR BLOCK  
10.0.0.0/16  
Specifies IP addresses: 10.0.0.0-10.0.255.255 (65,536 IP addresses)

DNS RESOLUTION  
 USE DNS HOSTNAMES IN THIS VCN ?  
Allows assignment of DNS hostname when launching an instance.

DNS LABEL  
datacenter1  
Only letters and numbers, starting with a letter. 15 characters max.

DNS DOMAIN NAME (READ-ONLY)  
datacenter1.oraclevcn.com

TAGS  
Tagging is a metadata system that allows you to organize and track resources within your tenancy. Tags are composed of keys and values which can be attached to resources.  
[Learn more about tagging](#)

TAG NAMESPACE	TAG KEY	VALUE
None (apply a free-form tag)		

View detail page after this resource is created

Create Virtual Cloud Network

Figure 154: CIDR Block

Networking - Virtual Cloud Networks - Virtual Cloud Network Details - CIDR Blocks

**userVCN**

Move Resource Add Tags Terminate

VCN Information Tags

Compartment: user OCID: ...oizicq Show Copy  
 Created: Mon, Aug 5, 2019, 21:35:21 UTC DNS Resolver: userVCN  
 CIDR Block: 30.0.0.0/16 Default Route Table: Default Route Table for userVCN  
 DNS Domain Name: DNS isn't enabled for this VCN

Resources

CIDR Blocks in user *Compartment*

A VCN must have at least 1 CIDR block. It can have multiple CIDR blocks as long as their IP address ranges do not overlap with each other or with a peered VCN. A VCN cannot have more than 5 CIDR blocks.

Add CIDR Block

CIDR Block	IP Address Range	# of IP Addresses
30.0.0.0/16	30.0.0.0 - 30.0.255.255	65536

Subnets (4)  
 CIDR Blocks (1)  
 Route Tables (2)  
 Internet Gateways (1)  
 Dynamic Routing Gateways (0)  
 Network Security Groups (0)

The cloud network created will have resources such as Internet and NAT gateway, Service gateway with access to the Oracle Services Network, A regional public subnet with access to the internet gateway, and A regional private subnet with access to the NAT gateway and service gateway.

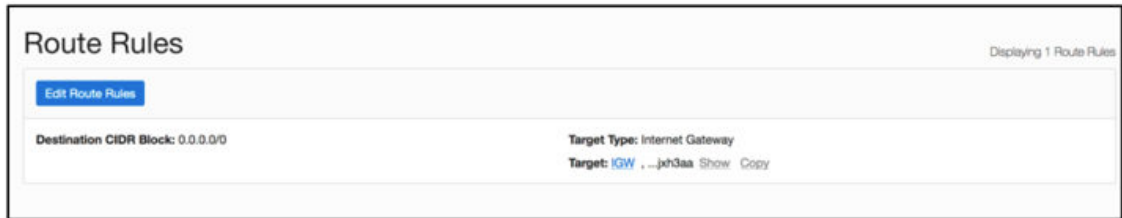
5. Create Subnets for the vSRX Virtual Firewall VCN created.

vSRX Virtual Firewall requires two public subnets and one or more private subnets for each individual instance group. One public subnet is for the management interface (fxp0), and the other is for a revenue (data) interface. The private subnets, connected to the other vSRX Virtual Firewall interfaces, ensure that all traffic between applications on the private subnets and the internet must pass through the vSRX Virtual Firewall instance.

a. Configure the Public Subnet (Management Interface)

To create this public subnet, click **Create Subnet** and define a route rule for the route table Default Route Table in which the internet gateway is configured as the route target for all traffic (0.0.0.0/0) as shown below.

Figure 155: Route Rules



For details about how to create subnets, see [VCNs and Subnets](#).

For the subnet's security list Default Security List, create an egress rule to allow traffic to all destinations. Create ingress rules that allow access on TCP port 22 from the public internet and on TCP port 80/443 for accessing the web application from the public internet as shown below.

Figure 156: Stateful Rules (Default Security List)

Stateful Rules				
Source: 0.0.0.0/0	IP Protocol: TCP	Source Port Range: All	Destination Port Range: 22	Allows: TCP traffic for ports: 22 SSH Remote Login Protocol
Source: 0.0.0.0/0	IP Protocol: ICMP	Type and Code: 3, 4		Allows: ICMP traffic for: 3, 4 Destination Unreachable: Fragmentation Needed and Don't Fragment was Set
Source: 10.0.0.0/16	IP Protocol: ICMP	Type and Code: 3		Allows: ICMP traffic for: 3 Destination Unreachable
Source: 0.0.0.0/0	IP Protocol: TCP	Source Port Range: All	Destination Port Range: 443	Allows: TCP traffic for ports: 443 HTTPS

b. Configure the Public Subnet (Revenue Interface)

Create this public subnet, and define a route rule for the route table Public RT in which the internet gateway is configured as the route target for all traffic (0.0.0.0/0).

For the subnet's security list Public Subnet SL, create an egress rule to allow traffic to all destinations. Create ingress rules that allow access on TCP port 80/443 for accessing the web application from the public internet and on ICMP if needed to check the connectivity as shown below.

Figure 157: Stateful Rules (Public Subnet Security List)

Stateful Rules				
Source: 0.0.0.0/0	IP Protocol: ICMP	Type and Code: All		Allows: ICMP traffic for: all types and codes
Source: 0.0.0.0/0	IP Protocol: TCP	Source Port Range: All	Destination Port Range: 443	Allows: TCP traffic for ports: 443 HTTPS

c. Configure the Private Subnet

Create this private subnet, and define a route rule for the route table Private RT in which the vSRX Virtual Firewall second vNIC's private IP address (10.0.3.3) is configured as the route target for all traffic 0.0.0.0/0.

**NOTE:** Configure the route rule after you create and attach the secondary VNICs.

6. Create Internet Gateway. To create internet gateway click **Internet Gateways**, set an internet gateway for the vSRX Virtual Firewall to be reachable from outside.

**Figure 158: Internet Gateway**

The screenshot shows the Oracle Cloud console interface for an Internet Gateway. On the left, a green hexagonal icon with 'VCN' is labeled 'AVAILABLE'. The main content area shows the details for 'uservcn' in the 'user' compartment. The 'VCN Information' tab is active, displaying the CIDR block '30.0.0.0/16', creation time 'Mon, Aug 5, 2019, 21:35:21 UTC', and other metadata. Below this, a table lists 'Internet Gateways in user Compartment' with one entry: 'igw30' in an 'Available' state, created on 'Mon, Aug 5, 2019, 21:46:30 UTC'. A 'Create Internet Gateway' button is visible above the table.

Networking > Virtual Cloud Networks > Virtual Cloud Network Details > Internet Gateways

**uservcn**

Move Resource Add Tags Terminate

VCN Information Tags

Compartment: user  
 Created: Mon, Aug 5, 2019, 21:35:21 UTC  
 CIDR Block: 30.0.0.0/16

OCID: ...obc9q Show Copy  
 DNS Resolver: uservcn  
 Default Route Table: Default Route Table for uservcn  
 DNS Domain Name: DNS isn't enabled for this VCN

Resources

Subnets (4)  
 CIDR Blocks (1)  
 Route Tables (2)  
**Internet Gateways (1)**  
 Dynamic Routing Gateways (0)  
 Network Security Groups (0)

Internet Gateways in user Compartment


Create Internet Gateway

Name	State	Created
igw30	Available	Mon, Aug 5, 2019, 21:46:30 UTC

7. Security list information to enable the SSH option. Select the default security list and the Ingress Rules like ICMP rule to allow ping from traffic by setting source CIDR of any any.

Figure 159: Security List Information

Networking > Virtual Cloud Networks > uservcn > Security List Details



### Default Security List for uservcn

Instance traffic is controlled by firewall rules on each Instance in addition to this Security List

[Move Resource](#)
[Add Tags](#)
[Terminate](#)

Security List Information Tags

---

**OCID:** ...zsmwva [Show](#) [Copy](#)
**Compartment:** user

**Created:** Mon, Aug 5, 2019, 21:35:21 UTC

Resources

Ingress Rules (2)

Egress Rules (1)

### Ingress Rules


[Add Ingress Rules](#)
[Edit](#)
[Remove](#)

<input type="checkbox"/>	Stateless ▾	Source	IP Protocol	Source Port Range	Destination Port Range	Type and Code	Allows
<input type="checkbox"/>	No	0.0.0.0/0	ICMP			All	ICMP traffic for: All
<input type="checkbox"/>	No	0.0.0.0/0	TCP	All	All		TCP traffic for ports: All

0 Selected

---

Networking > Virtual Cloud Networks > uservcn > Security List Details > Egress Rules



### Default Security List for uservcn

Instance traffic is controlled by firewall rules on each Instance in addition to this Security List

[Move Resource](#)
[Add Tags](#)
[Terminate](#)

Security List Information Tags

---

**OCID:** ...zsmwva [Show](#) [Copy](#)
**Compartment:** user

**Created:** Mon, Aug 5, 2019, 21:35:21 UTC

Resources

Ingress Rules (2)

Egress Rules (1)

### Egress Rules

[Add Egress Rules](#)
[Edit](#)
[Remove](#)

<input type="checkbox"/>	Stateless ▾	Destination	IP Protocol	Source Port Range	Destination Port Range	Type and Code	Allows
<input type="checkbox"/>	No	0.0.0.0/0	All Protocols				All traffic for all ports

0 Selected

8. Create your vSRX Virtual Firewall instance in the VNC created.
  - a. Open the navigation menu. Under **Core Infrastructure**, select **Compute** and click **Instances**, and then click on **Create Instance**.



b. Figure 160: Create Compute Instance

### Create Compute Instance

Name: jayinstance-dec2020

Create in compartment: j-40

iproc0l0ops (rootv)-40

#### Configure placement and hardware

The [availability domain](#) helps determine which shapes are available. A [shape](#) is a template allocated to an instance. The image is the operating system that runs on top of the shape.

Availability domain: AD 1 (nyTO:US-ASHBURN-AD-1) | AD 2 (nyTO:US-ASHBURN-AD-2)

Choose a fault domain for this instance

Image: ORACLE Linux Oracle Linux 7.9 Image Build: 2020.11.10-1

Shape: intel VM.Standard2.1 Virtual Machine, 1 core OCPU, 15 GB memory, 1 Gbps network bandwidth

### Browse All Images

An image is a template of a virtual hard drive that determines the operating system and other software for an instance. Images shown according to permissions in compartment j-40. [Change Compartment](#)

Platform Images | Oracle Images | Partner Images | **Custom Images** | Boot Volumes | Image OCID

Custom Images created or imported into your Oracle Cloud Infrastructure environment. See [Managing Custom Images](#) for more information.

Custom Image Name	Created
<input checked="" type="checkbox"/> user-dec2020-20.4R1.7	Thu, Dec 10, 2020, 02:01:42 UTC
<input type="checkbox"/> jay-oct20Q	Wed, Oct 23, 2019, 03:32:06 UTC
<input type="checkbox"/> jay-911im	Thu, Sep 12, 2019, 04:34:32 UTC
<input type="checkbox"/> j40ImageQ	Mon, Aug 5, 2019, 22:23:43 UTC
<input type="checkbox"/> j40-18.4ocI	Wed, Aug 7, 2019, 20:54:32 UTC

1 Selected Showing 5 items < 1 of 1 >

### Create Compute Instance

Name: userInstance-dec2020

Create in compartment: j-40

iproc0l0ops (rootv)-40

#### Configure placement and hardware

The [availability domain](#) helps determine which shapes are available. A [shape](#) is a template that determines the number of CPUs, amount of memory, and other resources allocated to an instance. The image is the operating system that runs on top of the shape.

Availability domain: AD 1 (nyTO:US-ASHBURN-AD-1) | AD 2 (nyTO:US-ASHBURN-AD-2) | AD 3 (nyTO:US-ASHBURN-AD-3)

Choose a fault domain for this instance

Image: user-dec2020-20.4R1.7 [Change Image](#)

Shape: intel VM.Standard2.4 Virtual Machine, 4 core OCPU, 60 GB memory, 4.1 Gbps network bandwidth [Change Shape](#)

### Configure networking

[Networking](#) is how your instance connects to the internet and other resources in the Console. To make sure you can [connect to your instance](#), assign a public IP address to the instance.

Network:  Select existing virtual cloud network  Create new virtual cloud network  Enter subnet OCID

Virtual cloud network in j-40: j40vcn [\(Change Compartment\)](#)

Subnet:  Select existing subnet  Create new public subnet

Subnet in j-40: pubsub40 3 (Regional) [\(Change Compartment\)](#)

Use network security groups to control traffic

Public IP address:  Assign a public IPv4 address  Do not assign a public IPv4 address

**!** Assigning a public IP address makes this instance accessible from the internet. If you're not sure whether you need a public IP address, you can always assign one later.

### Configure networking

[Networking](#) is how your instance connects to the internet and other resources in the Console. To make sure you can [connect to your instance](#), assign a public IP address to the instance.

Network:  Select existing virtual cloud network  Create new virtual cloud network  Enter subnet OCID

Virtual cloud network in j-40: j40vcn [\(Change Compartment\)](#)

Subnet:  Select existing subnet  Create new public subnet

Subnet in j-40: pubsub40 3 (Regional) [\(Change Compartment\)](#)

Use network security groups to control traffic

Public IP address:  Assign a public IPv4 address  Do not assign a public IPv4 address

**!** Assigning a public IP address makes this instance accessible from the internet. If you're not sure whether you need a public IP address, you can always assign one later.

- c. On the **Create Instance** page, enter the name of your instance.
- d. Choose an operating system or image source: Click **Change Image** and then click **Image Source** to select the image that you want to use. Select **Custom Images** and choose the image from the compartment. OCI vSRX Virtual Firewall image you want and then click **Select Image**.

Instance type – Virtual Machine.

- e. Choose Instance Shape: Click **Change Shape** to select the standard predefined OCI shape. Select the VM standard 2.4 which has 4 NICs and 4 OCPUs and click **Select Shape**.

**NOTE:** vSRX Virtual Firewall needs a minimum of 2 vCPUs to launch.

**Browse All Shapes**

A shape is a template that determines the number of CPUs, amount of memory, and other resources allocated to a newly created instance. See [Compute Shapes](#) for more information.

Instance type

**Virtual Machine**

A virtual machine is an independent computing environment that runs on top of physical bare metal hardware. ✓

**Bare Metal Machine**

A bare metal compute instance gives you dedicated physical server access for highest performance and strong isolation.

Shape series

**AMD** AMD Rome

Customizable OCPU count. For general purpose workloads.

**intel** Intel Skylake

Fixed OCPU count. Latest generation Intel Standard shapes. ✓

**Specialty and Legacy**

Earlier generation AMD and Intel Standard shapes. Always Free, Dense I/O, GPU, and HPC shapes.

Shape Name	OCPU	Memory (GB)	Local Disk	Network Bandwidth (Gbps)	Max. Total VNICs
<input type="checkbox"/> VM.Standard2.1	1	15	Block Storage Only	1	2
<input type="checkbox"/> VM.Standard2.2	2	30	Block Storage Only	2	2
<input checked="" type="checkbox"/> VM.Standard2.4	4	60	Block Storage Only	4.1	4
<input type="checkbox"/> VM.Standard2.8	8	120	Block Storage Only	8.2	8
<input type="checkbox"/> VM.Standard2.16	16	240	Block Storage Only	16.4	16
<input type="checkbox"/> VM.Standard2.24	24	320	Block Storage Only	24.6	24

1 Selected Showing 6 Items

Don't see the shape you want? [View your service limits and request an increase.](#)

- f. Under **Networking** tab select the virtual cloud network compartment, virtual cloud network, subnet compartments, subnet.
- g. To create a public IP address for the instance, select the **Assign a public IPv4 address** option.

**NOTE:** Accept default options for Availability Domain, Instance Type, and Instance Shape.

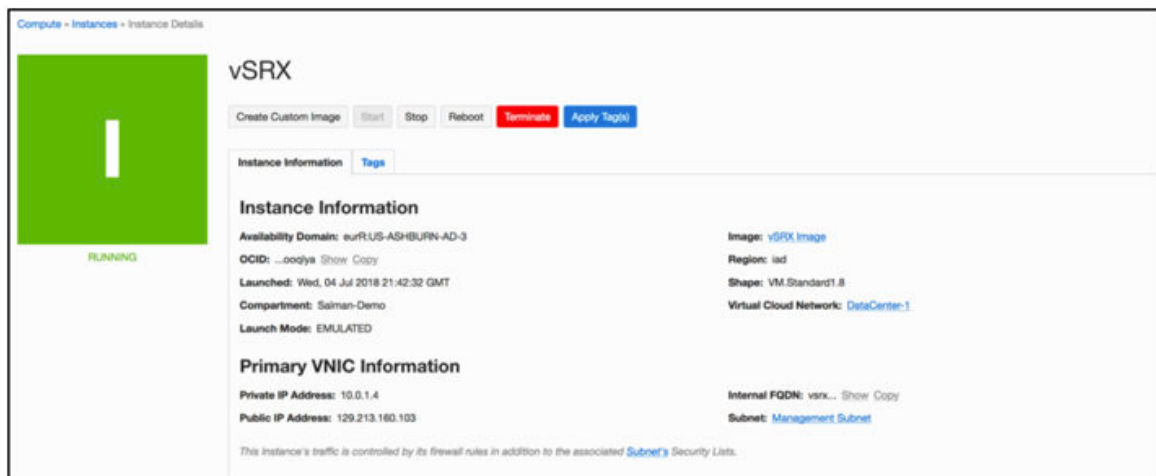
- h. Add SSH keys: Under **Add SSH keys** tab, you can paste a public key by selecting the **Paste public keys** option and paste the public SSH key that was generated or you can create a new SSH key to access the vSRX Virtual Firewall and then click **Create**.

After a few minutes, we can ssh the instance using the public IP allocated for the instance (this would be displayed on the instance). Reboot the instance after adding interfaces.

The instance is displayed in the Console in a provisioning state. Expect provisioning to take several minutes before the status updates to Running. Do not refresh the page. After the instance is running, allow another few minutes for the operating system to boot before you attempt to connect. When you are ready to connect to the instance, make a note of both the public IP address and the initial password.

After the instance is provisioned, details about it appear in the instance list as shown below.

**Figure 161: vSRX Virtual Firewall Instance Launched in OCI**



**NOTE:** The default user-name for the vSRX Virtual Firewall instance is `oci-user`. For example, to login to the vSRX Virtual Firewall using SSH:

```
user@host % ssh -i <private-key> oci-user@<vsrx-ip-address>
```

```
The authenticity of host 'vsrx-ip-address (vsrx-ip-address)' can't be established.
```

```
ECDSA key fingerprint is SHA256:z4X9YoWseVnKIeXh1kcpsVmAxTv1/E5l0Q51MU0N66g.
```

```
Are you sure you want to continue connecting (yes/no/[fingerprint])? yes
```

```
Warning: Permanently added 'vsrx-ip-address' (ECDSA) to the list of known hosts.
```

```
--- JUNOS 20.4R2.7 Kernel 64-bit XEN JNPR-11.0-20210220.a5d6a89_buil
```

```
oci-user>
```

```
oci-user> show version
Model: vSRX
Junos: 20.4R2.7
```

## 9. Adding interfaces for traffic.

Network interfaces need to be added after the instance has been created.

- a. Click **Attached VNICs** and select **Create VNIC** (ge000 -public and ge001-private). Select the subnet that was created and click **Save Changes** to add VNICs to the instance.

**NOTE:** Order of attaching network interfaces is important. You must map the first network interface to fxp0, then the second interface to ge-0/0/0, then to ge-0/0/1 and so on.

**Figure 162: Attached VNICs**

The figure displays two screenshots of the OCI console's 'Attached VNICs' page. The top screenshot shows a single VNIC attached to the instance 'dec2020-user-ocv2-20.4R1.91instance'. The bottom screenshot shows three VNICs attached to the instance 'dec2020-user-ocv2-20.4R1.91instance'.

Name	Subnet or VLAN	State	FQDN	VLAN Tag	MAC Address
dec2020-user-ocv2-20.4R1.91instance (Primary VNIC)	Subnet - public02	Attached	-	3681	02:00:17:08:04:D0
ge-0/0/0qcow	Subnet - public02	Attached	-	3681	02:00:17:08:04:D0
ge-0/0/1qcow	Subnet - private405	Attached	-	3689	02:00:17:08:39:99
ge-0/0/2qcow	Subnet - private406	Attached	-	3690	02:00:17:0A:47:24

10. Connect to the launched vSRX Virtual Firewall instance. Open your SSH client to access the launched vSRX Virtual Firewall instance. At first boot you can only SSH the vSRX Virtual Firewall. vSRX Virtual Firewall boots up with the default OCI configuration. Use your private key to SSH the vSRX Virtual Firewall instance.

## Upgrade the Junos OS for vSRX Virtual Firewall Software Release

You can upgrade the Junos OS for vSRX Virtual Firewall software using the CLI. Upgrading or downgrading Junos OS can take several hours, depending on the size and configuration of the network. Download the desired Junos OS Release for the vSRX Virtual Firewall 3.0 upgrade tgz file from the [Juniper Networks website](#). Example filename is **junos-install-vsrx3-x86-64-xxxxx.tgz**.

You also can upgrade using J-Web (see [J-Web](#)) or the Junos Space Network Management Platform (see [Junos Space](#)).

For the procedure on upgrading a specific Junos OS for vSRX Virtual Firewall software release, see the *Migration, Upgrade, and Downgrade Instructions* topic in the release-specific *vSRX Virtual Firewall Release Notes* available on the [vSRX TechLibrary](#) webpage.

# vSRX Virtual Firewall Licensing

## IN THIS CHAPTER

- Licenses for vSRX Virtual Firewall | 693

## Licenses for vSRX Virtual Firewall

- OCI supports Bring Your Own License (BYOL) licensing model. The BYOL license model allows you to customize your license, subscription and support to fit your needs. You can purchase BYOL from Juniper Networks or Juniper Networks authorized reseller.
- You need a license to use the software features on the vSRX Virtual Firewall. To find out the features supported on vSRX Virtual Firewall, see:
  - [Supported Features on vSRX](#).
  - [Juniper Agile Licensing Guide](#).
  - [Flex Software License](#).
- To add, delete, and manage licenses, see [Managing Licenses](#).