

Junos® OS

Flow-Based and Packet-Based Processing User Guide for Security Devices

Published
2023-06-15

Juniper Networks, Inc.
1133 Innovation Way
Sunnyvale, California 94089
USA
408-745-2000
www.juniper.net

Juniper Networks, the Juniper Networks logo, Juniper, and Junos are registered trademarks of Juniper Networks, Inc. in the United States and other countries. All other trademarks, service marks, registered marks, or registered service marks are the property of their respective owners.

Juniper Networks assumes no responsibility for any inaccuracies in this document. Juniper Networks reserves the right to change, modify, transfer, or otherwise revise this publication without notice.

Junos® OS Flow-Based and Packet-Based Processing User Guide for Security Devices
Copyright © 2023 Juniper Networks, Inc. All rights reserved.

The information in this document is current as of the date on the title page.

YEAR 2000 NOTICE

Juniper Networks hardware and software products are Year 2000 compliant. Junos OS has no known time-related limitations through the year 2038. However, the NTP application is known to have some difficulty in the year 2036.

END USER LICENSE AGREEMENT

The Juniper Networks product that is the subject of this technical documentation consists of (or is intended for use with) Juniper Networks software. Use of such software is subject to the terms and conditions of the End User License Agreement ("EULA") posted at <https://support.juniper.net/support/eula/>. By downloading, installing or using such software, you agree to the terms and conditions of that EULA.

Table of Contents

About This Guide | xvi

1

Overview

Traffic Processing on SRX Series Firewalls Overview | 2

Understanding Traffic Processing on Security Devices | 2

Understanding the Default Processing Behavior for IPv4 Traffic | 6

Understanding Traffic Processing on SRX210 and SRX320 Devices | 7

Understanding Traffic Processing on SRX3000 Line and SRX1400 Devices | 9

Understanding Traffic Processing on SRX4600 Devices | 14

Understanding Deployment Scenarios for the SRX4600 Firewall and Its Features | 14

Flow-Based Processing and Session Fundamentals | 16

Flow and Session Underlying Components Implemented Across SRX Series Firewalls | 17

Understanding Traffic Processing on SRX5000 Line Devices | 18

Understanding Session Cache | 30

Configuring IOC to NPC Mapping | 33

Understanding Flow Processing on SRX5K-SPC3 Devices | 35

Understanding SPC3 Software Architecture | 36

Understanding Load Distribution | 38

Understanding NP Session and Service Offload (SOF) | 40

Understanding J-Flow support on SPC3 | 40

Understanding Datapath Debug SPU Support (E2E) | 40

Understanding Fragmentation Handling, ISSU, and ISHU Support | 41

Central Point Architecture in Security Devices Overview | 42

Understanding SRX Series Firewalls Central Point Architecture | 42

Understanding Enhancements to Central Point Architecture for the SRX5000 Line | 46

Understanding Central Point Architecture Flow Support for GTP and SCTP | 48

2

Flow-Based Sessions

Flow-Based Sessions | 52

Understanding Session Characteristics for SRX Series Firewalls | 52

Example: Controlling Session Termination for SRX Series Firewalls | 54

Requirements | 54

Overview | 54

Configuration | 55

Verification | 56

Clearing Sessions for SRX Series Services Gateways | 56

Terminating Sessions for SRX Series Services Gateways | 56

Terminating a Specific Session for SRX Series Services Gateways | 57

Using Filters to Specify the Sessions to Be Terminated for SRX Series Services Gateways | 57

Configuring the Timeout Value for Multicast Flow Sessions | 57

TCP Sessions | 59

Understanding TCP Session Checks per Policy | 60

Example: Configuring TCP Packet Security Checks Per Policy | 61

Requirements | 62

Overview | 62

Configuration | 62

Verification | 63

Example: Disabling TCP Packet Security Checks for SRX Series Services Gateways | 63

Requirements | 63

Overview | 63

Configuration | 64

Verification | 64

Example: Setting the Maximum Segment Size for All TCP Sessions for SRX Series Firewalls | 65

Requirements | 65

Overview | 65

Configuration | 66

Verification | 67

TCP Out-of-State Packet Drop Logging Overview | 67

Understanding How Preserving Incoming Fragmentation Characteristics Can Improve Throughput | 70

ECMP Flow-Based Forwarding | 72

Understanding ECMP Flow-Based Forwarding | 72

Example: Configuring ECMP Flow-Based Forwarding | 76

Requirements | 76

Overview | 76

Configuration | 77

Verification | 82

Flow-Based Performance | 83

Expanding Session Capacity by Device | 84

Verifying the Current Session Capacity | 86

Flow Distribution and Packet-Ordering | 87

Understanding Load Distribution in SRX5000 Line Devices | 88

Understanding Packet-Ordering Function on SRX5000 Line Devices | 91

Understanding Session Distribution on SRX5000 Line Devices in Adaptive Mode | 94

PowerMode | 96

PowerMode | 96

PowerMode IPsec | 97

Understanding PMI First Path and Fast Path Processing | 97

Switching between PMI First Path and Fast Path Processing | 98

Fragmentation for Incoming IP Packets | 98

Fragmentation for Outgoing IP Packets | 99

NP session support | 99

Unified Policies Support for Flow | 99

Flow First Path for Unified Policies | 100

Understanding Flow Fast Path | 101

Configuring the Session Log for the Default Security Policy | 102

| [Configuring the Session Timeout for the Default Security Policy](#) | 103

TAP Mode for Flow Sessions | 104

[Understanding TAP Mode Support for Security Flow Sessions](#) | 104

[Example: Configuring Security Flow Sessions in TAP mode](#) | 105

[Requirements](#) | 105

[Overview](#) | 105

[Configuration](#) | 106

[Verification](#) | 107

Flow Management in SRX Series Devices Using VRF Routing Instance | 108

[Virtual Routing and Forwarding Instances in SD-WAN Deployments](#) | 109

[Flow Management Using VRF Routing Instance](#) | 110

[Virtual Routing and Forwarding Groups](#) | 110

[Understanding VRF groups](#) | 112

[Types of VRF groups](#) | 113

[VRF Movement](#) | 113

[VRF group-ID](#) | 114

[Configuring VRF groups](#) | 114

[VRF group Operations](#) | 115

[Flow Processing using Virtual Routing and Forwarding Group](#) | 116

[First Path Processing using VRF Group](#) | 117

[Fast Path Processing using VRF Group](#) | 118

[Example: Configuring a Security Policy to Permit VRF-Based Traffic from an IP Network to MPLS Network using VRF Group](#) | 119

[Example: Configuring a Security Policy to Permit VRF-Based Traffic from MPLS Network to an IP Network using VRF Group](#) | 125

[Example: Configuring a Security Policy to Permit VRF-Based Traffic from Public IP Network to MPLS Network using VRF Group](#) | 130

[Example: Configuring a Security Policy to Permit VRF-Based Traffic from MPLS Network to Public IP Network to using VRF Group](#) | 138

[Example: Configuring a Security Policy to Permit VRF-Based Traffic from MPLS Network to MPLS Network without NAT using VRF Group](#) | 146

[Example: Configuring a Security Policy to Permit VRF-Based Traffic from MPLS Network to MPLS Network using NAT and VRF Group](#) | 151

[Multicast Support in SD-WAN Deployments](#) | 159

3

Flow-Based Processing for IPv6**IPv6 Flow-Based Processing | 162**

IPv6 Advanced Flow | 162

Understanding IPv6 Flow Processing on SRX5400, SRX5600, and SRX5800 devices | 164

Enabling Flow-Based Processing for IPv6 Traffic | 167

Flow-Based Processing for IPv6 Traffic on Security Devices | 169

Using Filters to Display IPv6 Session and Flow Information for SRX Series Services Gateways | 171

Understanding Path MTU Messages for IPv6 Packets | 177**IPv6 Flow-Based Processing Overview | 179**

The IPv6 Packet Header and SRX Series Overview | 179

Understanding IPv6 Packet Header Extensions | 180

Understanding How SRX Series Firewalls Handle ICMPv6 Packets | 182

4

Monitoring Flow-Based Sessions and Establishing Parameters for Error Handling**Monitoring Security Flow Sessions | 186**

Monitoring Security Flow Sessions Overview | 186

Understanding How to Obtain Session Information for SRX Series Firewalls | 187

Displaying Global Session Parameters for All SRX Series Services Gateways | 189

Displaying a Summary of Sessions for SRX Series Services Gateways | 190

Displaying Session and Flow Information About Sessions for SRX Series Services Gateways | 190

Displaying Session and Flow Information About a Specific Session for SRX Series Services Gateways | 191

Using Filters to Display Session and Flow Information for SRX Series Services Gateways | 192

Information Provided in Session Log Entries for SRX Series Services Gateways | 193

Error Handling Extensions | 199

Understanding Chassis Manager FPC Fault Detection and Error Handling Enhancements | 200

Monitoring X2 Traffic | 203

Understanding X2 Traffic Monitoring | 204

Example: Configuring a Mirror Filter for X2 Traffic Monitoring | 208

Requirements | 208

Overview | 208

Configuration | 210

Verification | 212

5

Packet Based Forwarding

Packet-Based Forwarding | 215

Understanding Packet-Based Processing | 215

Understanding Selective Stateless Packet-Based Services | 216

Selective Stateless Packet-Based Services Configuration Overview | 218

Example: Configuring Selective Stateless Packet-Based Services for End-to-End Packet-Based Forwarding | 220

Requirements | 220

Overview | 221

Configuration | 222

Verification | 230

Example: Configuring Selective Stateless Packet-Based Services for Packet-Based to Flow-Based Forwarding | 235

Requirements | 235

Overview | 235

Configuration | 236

Verification | 245

Reverse Route Packet Mode using Virtual Router | 249

Understanding To-host Traffic on Virtual Router | 251

Express Path Overview | 252

Automated Express Path | 255

How does Express Path Process the Traffic? | 255

Platforms That Support Express Path | 256

How to Enable Express Path | 257

Express Path Network Processor | 257

Express Path Packet Processing on IOC cards | 260

Example: Configure Express Path on SRX5400, SRX5600, or SRX5800 Device with an IOC card | 262

Configuration Statements

aging | 272

all-tcp | 273

allow-dns-reply | 275

allow-embedded-icmp | 276

allow-reverse-ecmp | 278

application-services (Security Forwarding Process) | 279

apply-to-half-close-state | 282

cpu (resource-manager) | 283

destination-header | 285

destination-port (Security Forwarding Options) | 287

destination-prefix (Security Forwarding Options) | 293

early-ageout | 294

error | 295

fin-invalidate-session | 299

flow (Security Flow) | 302

force-ip-reassembly | 308

forwarding-process | 310

fpc error | 313

gre-in | 315

gre-out | 317

gre-performance-acceleration (Security Flow) | 319

high-watermark | 320

hop-by-hop-header | 322

icmpv6-malformed | 324

idle-timeout (System Services) | 325

inline-tap | 327

interface-in (Security Forwarding Options) | 329

interface-out (Security Forwarding Options) | 330

ipv4-template (Services) | 331

ipv6-extension-header | 333

ipv6-extension-header-limit | 335

ipv6-malformed-header | 337

ipv6-template (Services) | 338

low-latency | 340

low-watermark | 341

maximize-idp-sessions | 343

mirror-filter (Security Forwarding Options) | 345

mode (Security Forwarding Options) | 347

no-sequence-check | 350

np-cache (Flexible PIC Concentrator) | 351

output (Security Forwarding Options) | 353

packet-filter | 355

packet-log (Security Flow) | 357

packet-ordering-mode (Application Services) | 359

pending-sess-queue-length | 361

power-mode-disable | 362

pre-id-default-policy | 364

preserve-incoming-fragment-size | 367

propagate-settings | 369

protocol (Security Forwarding Options) | 370

resource-manager | 372

reverse-route-packet-mode-vr | 374

route-change-timeout | 375

rst-invalidate-session | 377

rst-sequence-check | 379

security-service (Security Forwarding Options) | 380

services-memory (resource-manager) | 382

session-memory (resource-manager) | 384

sampling | 386

services-offload | 388

session (System Services) | 390

session-limit (System Services) | 392

source-port (Security Forwarding Options) | 393

source-prefix (Security Forwarding Options) | 399

syn-flood-protection-mode | 400

tcp-initial-timeout | 402

tcp-mss (Security Flow) | 404

tcp-seq-ooo-window (Security Forwarding Options) | 406

tcp-session | 408

tcp-session-install-interval (Security Forwarding Options) | 410

time-wait-state | 411

traceoptions (Security) | 413

traceoptions (Security Flow) | 416

transport (Security Log) | 421

weight (Security) | 423

7

Operational Commands

clear firewall | 430

clear monitor security flow filter | 432

clear security flow ip-action | 433

clear security flow session all | 437

clear security flow session application | 439

clear security flow session application-traffic-control | 442

clear security flow session conn-tag | 446

clear security flow session destination-port | 448

clear security flow session destination-prefix | 450

clear security flow session family | 453

clear security flow session IDP | 455

clear security flow session interface | 458

clear security flow ip-action | 461

clear security flow session nat | 464

clear security flow session protocol | 467

clear security flow session resource-manager | 470

clear security flow session services-offload | 473

clear security flow session session-identifier | 477

clear security flow session source-port | 480

clear security flow session source-prefix | 482

clear security flow session tunnel | 485

clear security forward-options mirror filter | 488

monitor security flow file | 489

monitor security flow filter | 491

monitor security flow start | 494

monitor security flow stop | 495

monitor security packet-drop | 497

show chassis environment (Security) | 502

show chassis hardware (View) | 510

show chassis pic (Security) | 530

show chassis power | 533

show firewall (View) | 539

show interfaces (View Aggregated Ethernet) | 542

show interfaces flow-statistics | 558

show interfaces swfabx | 565

show monitor security flow | 567

show resource-manager cpu | 570

show resource-manager memory | 572

show resource-manager | 574

show security flow cp-session | 575

show security flow cp-session destination-port | 580

show security flow cp-session destination-prefix | 584

show security flow cp-session family | 588

show security flow cp-session protocol | 592

show security flow cp-session source-port | 596

show security flow cp-session source-prefix | 600

show security flow gate | 603

show security flow ip-action | 610

show security flow gate brief node | 622

show security flow gate destination-port | 630

show security flow gate destination-prefix | 635

show security flow gate protocol | 640

show security flow gate summary node | 645

show security flow pmi statistics | 652

show security flow session | 656

show security flow session brief node | 671

show security flow session destination-port | 677

show security flow session destination-prefix | 683

show security flow session extensive node | 689

show security flow session family | 699

show security flow session interface | 707

show security flow session nat | 713

show security flow session plugins | 719

show security flow session policy-id | 722

show security flow session pretty | 727

show security flow session protocol | 732

show security flow session resource-manager | 739

show security flow session services-offload | 745

show security flow session session-identifier | 753

show security flow session source-port | 760

show security flow session source-prefix | 766

show security flow session summary family | 772

show security flow session summary node | 776

show security flow session summary services-offload | 785

show security flow session tunnel | 790

show security flow statistics | 802

show security flow status | 808

show security forwarding-options mirror-filter | 819

show security forward-options resource-manager | 822

show security monitoring | 825

show security np-cache summary | 829

show security policies | 831

show security policies hit-count | 855

show security resource-manager group active | 862

show security resource-manager resource active | 867

show security resource-manager settings | 871

show security resource-manager summary | 874

show security screen ids-option | 876

show security screen statistics | 885

show security softwires | 901

show security zones | 903

show security zones type | 913

About This Guide

Use this guide to configure and monitor the flow of traffic or packet, on a device using flow-based processing and packet-based forwarding. Also, for using an extensive set of flow-based security features which include policies, screens, network address translation (NAT), and other flow-based services.

1

CHAPTER

Overview

[Traffic Processing on SRX Series Firewalls Overview | 2](#)

[Central Point Architecture in Security Devices Overview | 42](#)

Traffic Processing on SRX Series Firewalls Overview

IN THIS SECTION

- [Understanding Traffic Processing on Security Devices | 2](#)
- [Understanding the Default Processing Behavior for IPv4 Traffic | 6](#)
- [Understanding Traffic Processing on SRX210 and SRX320 Devices | 7](#)
- [Understanding Traffic Processing on SRX3000 Line and SRX1400 Devices | 9](#)
- [Understanding Traffic Processing on SRX4600 Devices | 14](#)
- [Understanding Traffic Processing on SRX5000 Line Devices | 18](#)
- [Understanding Session Cache | 30](#)
- [Configuring IOC to NPC Mapping | 33](#)
- [Understanding Flow Processing on SRX5K-SPC3 Devices | 35](#)

Junos OS for security devices integrates network security and routing capabilities of Juniper Networks. Packets that enter and exit a device undergo both packet-based and flow-based processing.

Understanding Traffic Processing on Security Devices

IN THIS SECTION

- [Understanding Flow-Based Processing | 3](#)
- [Understanding Packet-Based Processing | 5](#)

Junos OS for security devices integrates the world-class network security and routing capabilities of Juniper Networks. Junos OS includes a wide range of packet-based filtering, class-of-service (CoS) classifiers, and traffic-shaping features as well as a rich, extensive set of flow-based security features including policies, screens, network address translation (NAT), and other flow-based services.

Traffic that enters and exits a security device is processed according to features you configure, such as packet filters, security policies, and screens. For example, the software can determine:

- Whether the packet is allowed into the device
- Which firewall screens to apply to the packet
- The route the packet takes to reach its destination
- Which CoS to apply to the packet, if any
- Whether to apply NAT to translate the packet's IP address
- Whether the packet requires an Application Layer Gateway (ALG)

Packets that enter and exit a device undergo both packet-based and flow-based processing:

- Flow-based packet processing treats related packets, or a stream of packets, in the same way. Packet treatment depends on characteristics that were established for the first packet of the packet stream, which is referred to as a flow.

For the distributed processing architecture of the services gateway, all flow-based processing occurs on the SPU and sampling is multi-thread aware. Packet sequencing is maintained for the sampled packets.

- Packet-based, or stateless, packet processing treats packets discretely. Each packet is assessed individually for treatment.

For the distributed processing architecture of the services gateway, some packet-based processing, such as traffic shaping, occurs on the NPU. Some packet-based processing, such as application of classifiers to a packet, occurs on the SPU.

This topic includes the following sections:

Understanding Flow-Based Processing

A packet undergoes flow-based processing after packet-based filters and some screens have been applied to it. All flow-based processing for a single flow occurs on a single Services Processing Unit (SPU). An SPU processes the packets of a flow according to the security features and other services configured for the session.

[Figure 1 on page 4](#) shows a conceptual view of how flow-based traffic processing occurs on services gateway.

Figure 1: Traffic Flow for Flow-Based Processing

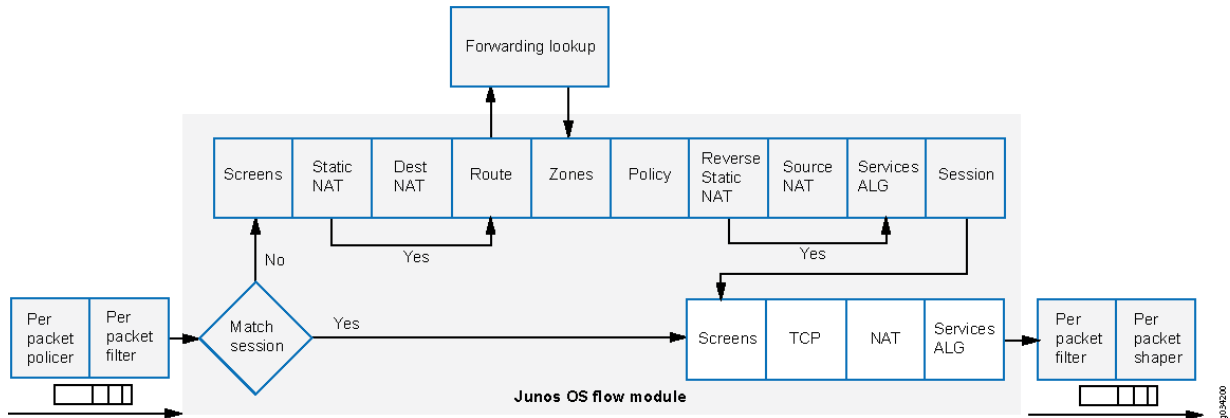

A flow is a stream of related packets that meet the same matching criteria and share the same characteristics. Junos OS treats packets belonging to the same flow in the same manner.

Configuration settings that determine the fate of a packet—such as the security policy that applies to it, if it requires an Application Layer Gateway (ALG), if NAT is applied to translate the packet’s source and/or destination IP address—are assessed for the first packet of a flow.

To determine if a flow exists for a packet, the NPU attempts to match the packet’s information to that of an existing session based on the following match criteria:

- Source address
- Destination address
- Source port
- Destination port
- Protocol
- Unique session token number for a given zone and virtual router

Zones and Policies

The security policy to be used for the first packet of a flow is cached in a flow table for use with the same flow and closely related flows. Security policies are associated with zones. A zone is a collection of interfaces that define a security boundary. A packet’s incoming zone, as determined by the interface through which it arrived, and its outgoing zone, as determined by the forwarding lookup, together determine which policy is used for packets of the flow.

Flows and Sessions

Flow-based packet processing, which is stateful, requires the creation of sessions. A session is created for the first packet of a flow for the following purposes:

- To store most of the security measures to be applied to the packets of the flow.
- To cache information about the state of the flow.

For example, logging and counting information for a flow is cached in its session. (Some stateful firewall screens rely on threshold values that pertain to individual sessions or across all sessions.)

- To allocate required resources for the flow for features such as NAT.
- To provide a framework for features such as ALGs and firewall features.

Most packet processing occurs in the context of a flow, including:

- Management of policies, NAT, zones, and most screens.
- Management of ALGs and authentication.

Understanding Packet-Based Processing

A packet undergoes packet-based processing when it is removed from the queue on its input interface and before it is added to the queue on its output interface.

Packet-based processing applies stateless firewall filters, CoS features, and some screens to discrete packets.

- When a packet arrives at an interface, sanity checks, packet-based filters, some CoS features, and some screens are applied to it.
- Before a packet leaves the device, any packet-based filters, some CoS features, and some screens associated with the interface are applied to the packet.

Filters and CoS features are typically associated with one or more interfaces to influence which packets are allowed to transit the system and to apply special actions to packets as necessary.

The following topics describe the kinds of packet-based features that you can configure and apply to transit traffic.

Stateless Firewall Filters

Also referred to as access control lists (ACLs), stateless firewall filters control access and limit traffic rates. They statically evaluate the contents of packets transiting the device from a source to a

destination, or packets originating from or destined for the Routing Engine. A stateless *firewall filter* evaluates every packet, including fragmented packets.

You can apply a stateless firewall filter to an input or output interface, or to both. A filter contains one or more terms, and each term consists of two components—match conditions and actions. By default, a packet that does not match a firewall filter is discarded.

You can plan and design stateless firewall filters to be used for various purposes—for example, to limit traffic to certain protocols, IP source or destination addresses, or data rates. Stateless firewall filters are executed on the NPU.

Class-of-Service Features

CoS features allow you to classify and shape traffic. CoS features are executed on the NPU.

- Behavior aggregate (BA) classifiers—These classifiers operate on packets as they enter the device. Using behavior aggregate classifiers, the device aggregates different types of traffic into a single forwarding class to receive the same forwarding treatment. BA classifiers allow you to set the forwarding class and loss priority of a packet based on the Differentiated Service (DiffServ) value.
- Traffic shaping—You can shape traffic by assigning service levels with different delay, *jitter*, and packet loss characteristics to particular applications served by specific traffic flows. Traffic shaping is especially useful for real-time applications, such as voice and video transmission.

Screens

Some screens, such as denial-of-service (DoS) screens, are applied to a packet outside the flow process. They are executed on the Network Processing Unit (NPU).

Understanding the Default Processing Behavior for IPv4 Traffic

Flow-based processing mode is required for security features such as zones, screens, and firewall policies to function. By default, the SRX Series Firewall is enabled for flow-based forwarding for IPv4 traffic on all devices, apart from the SRX300 Series and SRX550M devices that are set to drop mode. Starting with Junos OS Release 15.1X49-D70 and Junos OS Release 17.3R1, for the SRX1500 series, SRX4100, SRX4200, SRX5400, SRX5600, SRX5800 and vSRX Virtual Firewall devices, you do *not* need to reboot the device when you are switching modes between flow mode, packet mode, and drop mode. For SRX300 Series and SRX550M devices, you *must* reboot the device when switching between flow mode, packet mode, and drop mode.

SRX300 Series and SRX550M

For the SRX300 Series and the SRX550M devices, the default processing mode is set to drop mode because of memory constraints. In this case, you must reboot the device after changing the processing mode from the drop mode default to flow-based processing mode or packet-based processing mode—that is, between modes on these devices.

NOTE: For drop mode processing, the traffic is dropped directly, it is not forwarded. It differs from packet-mode processing for which the traffic is handled but no security processes are applied.

Configuring an SRX Series Device as a Border Router

When an SRX Series Firewall of any type is enabled for flow-based processing or drop mode, to configure the device as a border router you must change the mode to packet-based processing for MPLS. In this case, to configure the SRX Series Firewall to packet mode for MPLS, use the `set security forwarding-options family mpls mode packet-based` statement.

NOTE: As mentioned previously, for SRX300 Series and the SRX550M devices, whenever you change processing modes, you must reboot the device.

Understanding Traffic Processing on SRX210 and SRX320 Devices

IN THIS SECTION

- [Understanding Flow Processing and Session Management | 8](#)
- [Understanding First-Packet Processing | 8](#)
- [Understanding Session Creation | 8](#)
- [Understanding Fast-Path Processing | 9](#)

This topic describes the process that the SRX210 and SRX320 Services Gateways undertake in establishing a session for packets belonging to a flow that transits the device. The flow services of the SRX210 and SRX320 devices are single-threaded and non-distributed. Although they differ from the other SRX Series Firewalls in this respect, the same flow model is followed and the same command line interface (CLI) is implemented.

To illustrate session establishment and the packet “walk” including the points at which services are applied to the packets of a flow, the example described in the following sections uses the simple case of a unicast session:

Understanding Flow Processing and Session Management

This topic explains how a session is set up to process the packets composing a flow. In the following topic, the SPU refers to the data plane thread of the SRX210 or SRX320 Firewall.

At the outset, the data plane thread fetches the packet and performs basic sanity checks on it. Then it processes the packet for stateless filters and CoS classifiers and applies some screens.

Understanding First-Packet Processing

To determine if a packet belongs to an existing flow, the device attempts to match the packet's information to that of an existing session based on the following six match criteria:

- Source address
- Destination address
- Source port
- Destination port
- Protocol
- Unique token from a given zone and virtual router

The SPU checks its session table for an existing session for the packet. If no existent session is found, the SPU sets up a session for the flow. If a session match is found, the session has already been created, so the SPU performs fast-path processing on the packet.

Understanding Session Creation

In setting up the session, the SPU executes the following services for the packet:

- Screens
- Route lookup
- Policy lookup
- Service lookup
- NAT, if required

After a session is set up, it is used for all packets belonging to the flow. Packets of a flow are processed according to the parameters of its session. For the remainder of the steps entailed in packet processing, proceed to Step 1 in “Fast-Path Processing”. All packets undergo fast-path processing.

Understanding Fast-Path Processing

If a packet matches a session, Junos OS performs fast-path processing as described in the following steps. After a session has been set up for the first packet in a flow, also undergoes fast-path processing. All packets undergo fast-path processing.

1. The SPU applies flow-based security features to the packet.
 - Configured screens are applied.
 - TCP checks are performed.
 - Flow services, such as NAT, ALG, and IPsec are applied, if required.
2. The SPU prepares the packet for forwarding and transmits it.
 - Routing packet filters are applied.
 - Traffic shaping is applied.
 - Traffic prioritizing is applied.
 - Traffic scheduling is applied.
 - The packet is transmitted.

Understanding Traffic Processing on SRX3000 Line and SRX1400 Devices

IN THIS SECTION

- [Components Involved in Setting Up a Session | 10](#)
- [Understanding the Data Path for Unicast Sessions | 11](#)
- [Session Lookup and Packet Match Criteria | 11](#)
- [Understanding Session Creation: First Packet Processing | 11](#)
- [Understanding Fast-Path Processing | 13](#)

Junos OS for the SRX1400, SRX3400 and SRX3600 Services Gateways integrates the world-class network security and routing capabilities of Juniper networks. Junos OS for these service gateways includes the wide range of security services including policies, screens, network address translation, class-of-service classifiers, and the rich, extensive set of flow-based services that are also supported on the other devices in the services gateways.

The distributed parallel processing architecture of the SRX1400, SRX3400 and SRX3600 devices includes multiple processors to manage sessions and run security and other services processing. This architecture provides greater flexibility and allows for high throughput and fast performance.

The following sections describe the processing architecture using SRX3400 and SRX3600 devices as an example:

This topic includes the following information:

Components Involved in Setting Up a Session

Here is an overview of the main components involved in setting up a session for a packet and processing the packets as they transit the SRX3400 and SRX3600 devices:

- **Services Processing Units (SPUs)**—The main processors of the SRX3400 and SRX3600 devices reside on Services Processing Cards (SPCs). They establish and manage traffic flows and perform most of the packet processing on a packet as it transits the device. Each SPU maintains a hash table for fast session lookup. The SPU performs all flow-based processing for a packet, including application of security services, classifiers, and traffic shapers. All packets that belong to the same flow are processed by the same SPU.

The SPU maintains a session table with entries for all sessions that it established and whose packets it processes. When an SPU receives a packet from an NPU, it checks its session table to ensure that the packet belongs to it.

For SRX3400 and SRX3600 devices, one SPU acts in concert performing its regular session management and flow processing functions and acting as a central point in which it arbitrates sessions and allocates resources. When an SPU performs in this manner it is said to be in combo mode.

- **Central Point**—The central point is used to allocate session management to SPUs based on load balancing criteria. It distributes sessions in an intelligent way to avoid occurrences in which multiple SPUs might wrongly handle the same flow. The central point follows load balancing criteria in allocating sessions to SPUs. If the session exists, the central point forwards packets for that flow to the SPU hosting it. It also redirects packets to the correct SPU in the event that the NPU fails to do so.

For the SRX3400 and SRX3600 devices, one SPU always runs in what is referred to as combo mode in which it implements both the functionality of the central point and the flow and session

management functionality. In combo mode, the SPU and the central point share the same load-balancing thread (LBT) and packet-ordering thread (POT) infrastructure. .

- Routing Engine (RE)—The Routing Engine runs the control plane and manages the Control Plane Processor (CPP).

Understanding the Data Path for Unicast Sessions

Junos OS for the SRX3400 and SRX3600 Services Gateways is a distributed parallel processing high throughput and high performance system. This topic describes the process of establishing a session for packets belonging to a flow that transits the device.

To illustrate session establishment and the packet “walk” including the points at which services are applied to the packets of a flow, the following example uses the simple case of a unicast session. This packet “walk” brings together the packet-based processing and flow-based processing that the Junos OS performs on the packet.

Session Lookup and Packet Match Criteria

To determine if a packet belongs to an existing flow, the device attempts to match the packet’s information to that of an existing session based on the following six match criteria:

- Source address
- Destination address
- Source port
- Destination port
- Protocol
- Unique token from a given zone and virtual router

Understanding Session Creation: First Packet Processing

This topic explains how a session is set up to process the packets composing a flow. To illustrate the process, this topic uses an example with a source “a” and a destination “b”. The direction from source to destination for the packets of the flow is referred to as (a -> b). The direction from destination to source is referred to as (b -> a).

1. A packet arrives at an interface on the device and the IOC processes it.

The IOC dequeues the packet and sends it to the NPU with which it communicates.

2. The NPU receives the packet from the IOC and processes it.

- The NPU performs basic sanity checks on the packet and applies some screens configured for the interface to the packet.
- If a session match is found, the session has already been created on an SPU that was assigned to it, so the NPU forwards the packet to the SPU for processing along with the session ID.

Example: Packet (a ->b) arrives at NPU1 from IOC1. NPU1 performs sanity checks and applies DoS screens to the packet. NPU1 checks its session table for a tuple match and no existing session is found. NPU1 forwards the packet to the central point on SPU1 for assignment to an SPU.

3. The central point creates a session with a “Pending” state.

The central point maintains a global session table that includes entries for all sessions that exist across all SPUs on the device. It participates in session creation and delegates and arbitrates session resources allocation.

This process entails the following parts:

- a. The central point checks its session table and gate table to determine if a session or a gate exists for the packet it receives from the NPU. (An NPU has forwarded a packet to the central point because its table indicates there is no session for it. The central point verifies this information before allocating an SPU for the session.)
- b. If there is no entry that matches the packet in either table, the central point creates a pending wing for the session and selects an SPU to be used for the session, based on its load-balancing algorithm.
- c. The central point forwards the first packet of the flow to the selected SPU in a message telling it to set up a session locally to be used for the packet flow.

Example: The central point creates pending wing (a ->b) for the session. It selects SPU1 to be used for the session. It sends SPU1 the (a->b) packet along with a message to create a session for it. (It happens to be the case that SPU1 is the SPU that runs in combo mode. Therefore, its session-management and flow-processing services are used for the session.

4. The SPU sets up the session.

Each SPU, too, has a session table, which contains information about its sessions. When the SPU receives a message from the central point to set up a session, it checks its session table to ensure that a session does not already exist for the packet.

- a. If there is no existing session for the packet, the SPU sets up the session locally.
- b. The SPU sends a message to the central point, telling it to install the session.

During first-packet processing, if NAT is enabled, the SPU allocates IP address resources for NAT. In this case, the first-packet processing for the session is suspended until the NAT allocation process is completed.

The SPU adds to the queue any additional packets for the flow that it might receive until the session has been installed.

Example: SPU1 creates the session for (a ->b) and sends a message back to the central point (implemented on the same SPU) telling it to install the pending session.

5. The central point installs the session.

- It sets the state for the session's pending wing to active.
- It installs the reverse wing for the session as an active wing.
- It sends an ACK (acknowledge) message to the SPU, indicating that the session is installed.

Example: The central point receives a message from SPU1 to install the session for (a->b). It sets the session state for (a->b) wing to active. It installs the reverse wing (b->a) for the session and makes it active; this allows for delivery of packets from the reverse direction of the flow: destination (b) to be delivered to the source (a).

6. The SPU sets up the session on the ingress and egress NPUs.

NPUs maintain information about a session for packet forwarding and delivery. Session information is set up on the egress and ingress NPUs (which sometimes are the same) so that packets can be sent directly to the SPU that manages their flows and not to the central point for redirection.

7. Fast-path processing takes place.

For the remainder of the steps entailed in packet processing, proceed to Step 1 in "Understanding Fast-Path Processing".

Understanding Fast-Path Processing

All packets undergo fast-path processing. However, if a session exists for a packet, the packet undergoes fast-path processing and bypasses the first-packet process. When there is already a session for the packet's flow, the packet does not transit the central point.

Here is how fast-path processing works: NPUs at the egress and ingress interfaces contain session tables that include the identification of the SPU that manages a packet's flow. Because the NPUs have this session information, all traffic for the flow, including reverse traffic, is sent directly to that SPU for processing.

On SRX1400, SRX3400, and SRX3600 devices, the `iflset` functionality is not supported for aggregated interfaces like `reth`.

Understanding Traffic Processing on SRX4600 Devices

IN THIS SECTION

- [Understanding Deployment Scenarios for the SRX4600 Firewall and Its Features | 14](#)
- [Flow-Based Processing and Session Fundamentals | 16](#)
- [Flow and Session Underlying Components Implemented Across SRX Series Firewalls | 17](#)

The Juniper Networks SRX4600 Firewall integrates flow-based security and routing services, including advanced security and threat mitigation and traditional stateful firewall security. The Junos OS flow-based infrastructure provides the foundation and framework for Layer 4 through Layer 7 application-based services. The SRX4600 Firewall is designed to be deployed as an integrated firewall at the large enterprise data center edge and data center core, and the campus edge. It can also be deployed as an LTE security gateway and a Gi/SGi firewall.

This topic includes the following content:

Understanding Deployment Scenarios for the SRX4600 Firewall and Its Features

The SRX4600 Firewall can be deployed in many areas to secure your environment and its resources. It is often used to protect the data center edge and core in the following ways:

- Deploying the SRX4600 Firewall as a Data Center Edge Firewall

You can deploy the SRX4600 Firewall at the edge of your data center to provide the applications and services that it hosts with optimum protection. Every data center has an ingress point to allow clients access to the data center's services, but malicious aggressors can take advantage of it to launch attacks against these services. A large amount of traffic coming into the data center is ingress internet traffic. For that reason alone, deploying robust, multi-layered security at the data center edge is essential. The SRX4600 Firewall effectively and reliably blocks attacks, and it allows you to configure the system to thwart specific kinds of attacks. The SRX4600 Firewall supports Juniper's Software-Defined Secure Network (SDSN) framework, including Juniper Advanced Threat Prevention Cloud (ATP Cloud), which is built around automated and actionable intelligence that can be shared quickly to recognize and mitigate threats. Figure 2 shows the SRX4600 Firewall deployed at the data center edge in conjunction with an MX480 router and EX Series switches.

Figure 2: Deploying the SRX4600 Firewall at the Data Center Edge

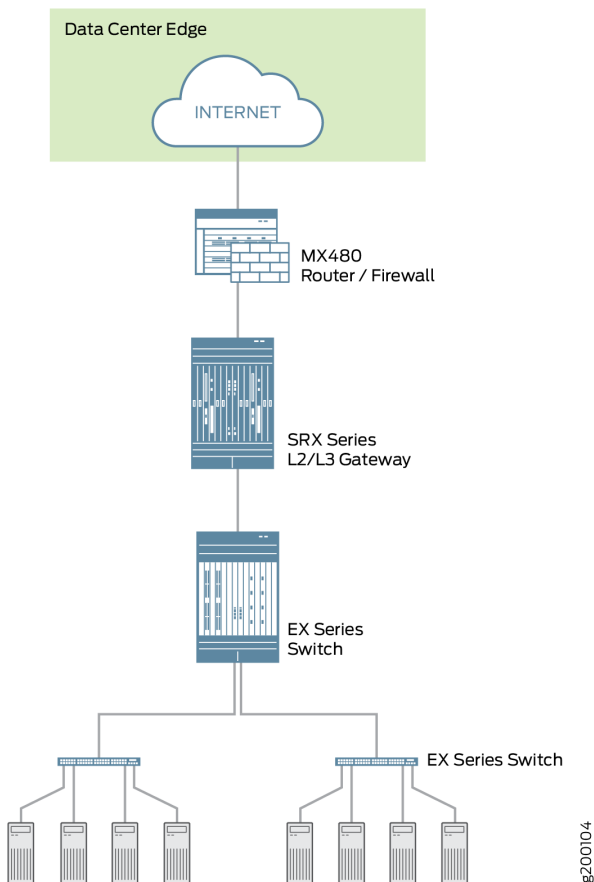

- Deploying the SRX4600 Firewall at the Data Center Core

You can deploy the SRX4600 Firewall at the data center core to provide enhanced security and to ensure that compliance requirements are met. Data center processing has become increasingly dynamic necessitating clear network definition and compliance requirements enforcement. To ensure compliance, you can use the SRX4600 Firewall to segment your overall network into individual server networks and secure traffic within them. The SRX4600 Firewall provides high availability and automation, and its high performance Layer 3 and Layer 4 services meet the security requirements of the data center core. Figure 3 shows the SRX4600 Firewall deployed as a multi-layered firewall at the data center core.

Figure 3: Deploying the SRX4600 Firewall at the Data Center Core

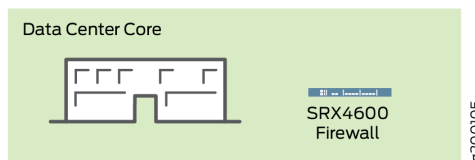

In addition to its advanced anti-malware features, the SRX4600 Firewall supports the following features:

- Stateful firewall
- Application security suite
- Content Security (Sophos AV, Web filtering, antispam)
- IDP
- High availability (Chassis cluster)
 - Dual HA control ports (10G)
 - MACsec support for HA ports
- Ethernet interfaces through QSFP28 (100G/40G/4x10G modes), QSFP+ (40G/4x10G modes) and SFP+ (10G mode)
- IPsec VPN, including AutoVPN and Group VPNv2
- QoS and network services
- J-Web
- Routing policies with multicast

Flow-Based Processing and Session Fundamentals

To understand flow processing on the SRX4600 Firewall, it is important to understand the fundamentals of flow.

A *flow* is a stream of related packets that meet the same matching criteria and share the same characteristics. Junos OS treats packets that belong to the same flow in the same way. The architecture of an SRX Series services gateway and how it handles packet flows are tightly coupled. Consequently, in part, flow is implemented differently across the family of SRX Series Firewalls because of their architectural differences.

Flow-based packet processing, which is stateful, requires the creation of *sessions*. Sessions are created based on routing and other traffic classification information to store information and allocate resources for a flow. Sessions cache information about the state of the flow, and they store most of the security measures to be applied to packets of the flow. Because of the architectural differences across devices, sessions are also managed differently by different devices.

Regardless of these differences, conceptually the flow process is the same across all services gateways, and sessions serve the same purposes and have the same features.

Flow and Session Underlying Components Implemented Across SRX Series Firewalls

SRX Series Firewalls use the same infrastructure components to support flow and manage sessions, but not all devices implement all of them.

To understand flow, it is essential to understand the following components and how they are used:

- The Services Processing Unit (SPU)

An SPU manages the session for a packet flow. It applies security features and other services to the packet. It also applies packet-based stateless firewall filters, classifiers, and traffic shapers to the packet.

- The central point (CP)

The central point is an SPU that the system uses to allocate resources and distribute session management among SPUs. When the first packet of a flow is processed, the central point determines which SPU to use for that packet's session. The SRX4600 Firewall does not implement a central point.

- The Network Processing Unit (NPU) and the Network Processing session

An NPU is a processor that runs on an I/O card (IOC) and processes packets discretely. When a flow is created, subsequent packets of the flow are matched to the session on the NPU. The NPU handles additional processing such as TCP sequence check, time-to-live (TTL) processing, and Layer 2 header translation. An NPU improves performance in that extra packet forwarding between a session-SPU and a hash-SPU is avoided. The SRX4600 Firewall implements an NPU.

The SRX4600 Firewall flow architecture has been improved to optimize use of the SRX4600 device's advanced multi-core Xeon™ Processors. The SRX4600 Firewall implements the use of a dedicated session thread to circumvent problems such as management of out-of-order packets in a flow. It utilizes the network processing session to ensure that packets are forwarded to the right, dedicated thread. Packets are distributed to different threads in accord with the hash-based session distribution model.

Understanding Traffic Processing on SRX5000 Line Devices

IN THIS SECTION

- [Understanding First-Packet Processing | 19](#)
- [Understanding Fast-Path Processing | 20](#)
- [Understanding the Data Path for Unicast Sessions | 21](#)
- [Understanding Services Processing Units | 28](#)
- [Understanding Scheduler Characteristics | 29](#)
- [Understanding Network Processor Bundling | 29](#)

Junos OS on SRX5000 devices is a distributed, parallel processing, high-throughput and high-performance system. The distributed parallel processing architecture of the SRX5000 line of services gateways includes multiple processors to manage sessions and run security and other services processing. This architecture provides greater flexibility and allows for high throughput and fast performance.

NOTE: In SRX1400, SRX3400, SRX3600, SRX5400, SRX5600, and SRX5800 devices, IKE negotiations involving NAT traversal do not work if the IKE peer is behind a NAT device that will change the source IP address of the IKE packets during the negotiation. For example, if the NAT device is configured with DIP, it changes the source IP because the IKE protocol switches the UDP port from 500 to 4500.

The I/O cards (IOCs) and Services Processing Cards (SPCs) on SRX5000 line devices contain processing units that process a packet as it traverses the device. An IOC has one or more Network Processing Units (NPUs), and a SPC has one or more Services Processing Units (SPUs).

These processing units have different responsibilities. All flow-based services for a packet are executed on a single SPU. The responsibilities of these NPUs are not clearly delineated in regard to the other kind of services that run on them. .)

For example:

- An NPU processes packets discretely. It performs sanity checks and applies some screens that are configured for the interface, such as denial-of-service (DoS) screens, to the packet.

- An SPU manages the session for the packet flow and applies security features and other services to the packet. It also applies packet-based stateless firewall filters, classifiers, and traffic shapers to the packet.
- An NPU forwards a packet to the SPU using the hash algorithm. However, for some applications, like ALG, the system will need to query the application central point to determine on which SPU the packet should be processed.

These discrete, cooperating parts of the system, including the central point, each store the information identifying whether a session exists for a stream of packets and the information against which a packet is matched to determine if it belongs to an existing session.

This architecture allows the device to distribute processing of all sessions across multiple SPUs. It also allows an NPU to determine if a session exists for a packet, to check the packet, and to apply screens to the packet. How a packet is handled depends on whether it is the first packet in a flow.

The following sections describe the processing architecture using SRX5400, SRX5600, and SRX5800 devices as an example:

Understanding First-Packet Processing

Figure 4 on page 19 illustrates the path the first packet in a flow takes as it enters the device—the NPU determines that no session exists for the packet, and the NPU sends the packet to the distributed central point to set up a distributed central point session. The distributed central point then sends a message to the application central point to select the SPU to set up a session for the packet and to process the packet. The distributed central point then sends the packet to that SPU. The SPU processes the packet and sends it to the NPU for transmission from the device. (This high-level description does not address application of features to a packet.)

Figure 4: First-Packet Processing

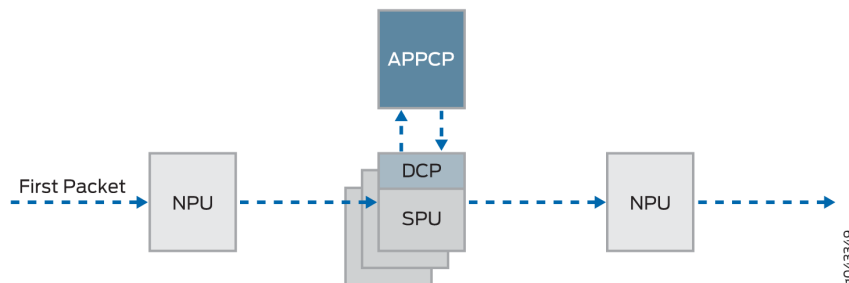

After the first packet in a flow has traversed the system and a session has been established for it, it undergoes fast-path processing.

Subsequent packets in the flow also undergo fast-path processing; in this case, after each packet enters the session and the NPU finds a match for it in its session table, the NPU forwards the packet to the SPU that manages its session.

Figure 5 on page 20 illustrates fast-path processing. This is the path a packet takes when a flow has already been established for its related packets. (It is also the path that the first packet in a flow takes after the session for the flow that the packet initiated has been set up.) After the packet enters the device, the NPU finds a match for the packet in its session table, and it forwards the packet to the SPU that manages the packet's session. Note that the packet bypasses interaction with the central point.

Understanding Fast-Path Processing

The following section explains how a session is created and the process a packet undergoes as it transits the device.

Figure 5: Fast-Path Processing

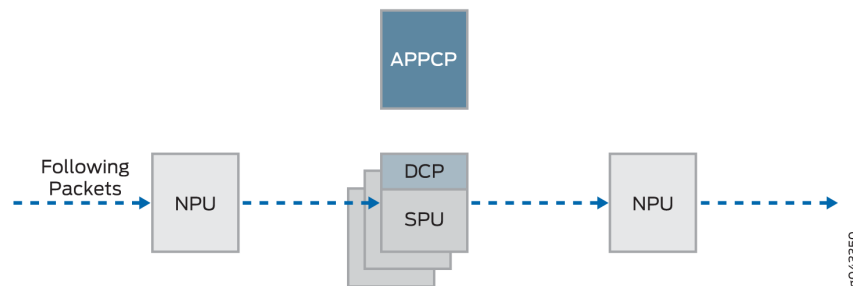

Here is an overview of the main components involved in setting up a session for a packet and processing packets both discretely and as part of a flow as they transit the SRX5400, SRX5600, and SRX5800 devices.

- Network Processing Units (NPUs)—NPUs reside on IOCs. They handle packet sanity checking and application of some screens. NPUs maintain session tables that they use to determine if a session exists for an incoming packet or for reverse traffic.

The NPU session table contains an entry for a session if the session is established on an SPU for a packet that had previously entered the device via the interface and was processed by this NPU. The SPU installs the session in the NPU table when it creates the session.

An NPU determines if a session exists for a packet by checking the packet information against its session table. If the packet matches an existing session, the NPU sends the packet and the metadata for it to the SPU. If there is no session, the NPUs sends the packet to one SPU which is calculated using the hash algorithm.

- **Services Processing Units (SPUs)**—The main processors of the SRX5400, SRX5600, and SRX5800 devices reside on SPCs. SPUs establish and manage traffic flows and perform most of the packet processing on a packet as it transits the device. Each SPU maintains a hash table for fast session lookup. The SPU applies stateless firewall filters, classifiers, and traffic shapers to traffic. An SPU performs all flow-based processing for a packet and most packet-based processing. Each multicore SPU processes packets independently with minimum interaction among SPUs on the same or different SPC. All packets that belong to the same flow are processed by the same SPU.

The SPU maintains a session table with entries for all sessions that it established and whose packets it processes. When an SPU receives a packet from an NPU, it checks its session table to ensure that the packet belongs to it. It also checks its session table when it receives a packet from the distributed central point and sends a message to establish a session for that packet to verify that there is not an existing session for the packet.

- **Central point**—The central point architecture is divided into two modules, the application central point and the distributed central point. The application central point is responsible for global resource management and load balancing, while the distributed central point is responsible for traffic identification (global session matching). The application central point functionality runs on the dedicated central point SPU, while the distributed central point functionality is distributed to the rest of the SPUs. Now the central point sessions are no longer on the dedicated central point SPU, but with the distributed central point on other flow SPUs.
- **Routing Engine**—The Routing Engine runs the control plane.

Understanding the Data Path for Unicast Sessions

This section describes the process of establishing a session for packets belonging to a flow that transits the device.

To illustrate session establishment and the packet “walk” including the points at which services are applied to the packets in a flow, this example uses the simple case of a unicast session.

This packet “walk” brings together the packet-based processing and flow-based processing that Junos OS performs on the packet.

Session Lookup and Packet-Match Criteria

To determine if a packet belongs to an existing flow, the device attempts to match the packet’s information to that of an existing session based on the following six match criteria:

- Source address
- Destination address
- Source port

- Destination port
- Protocol
- Unique token from a given zone and virtual router

Understanding Session Creation: First-Packet Processing

This section explains how a session is set up to process the packets composing a flow. To illustrate the process, this section uses an example with a source “a” and a destination “b”. The direction from source to destination for the packets of the flow is referred to as (a ->b). The direction from destination to source is referred to as (b->a).

Step 1. A Packet Arrives at an Interface on the Device And the NPU Processes It.

This section describes how a packet is handled when it arrives at an SRX Series Firewall ingress IOC.

1. The packet arrives at the device’s IOC and is processed by the NPU on the IOC.
2. The NPU performs basic sanity checks on the packet and applies some screens configured for the interface to the packet.
3. The NPU checks its session table for an existing session for the packet. (It checks the packet’s tuple against those of packets for existing sessions in its session table.)
 - a. If no existing session is found, the NPU forwards the packet to the hash SPU.
 - b. If a session match is found, the session has already been created on an SPU that was assigned to it, so the NPU forwards the packet to the SPU for processing along with the session ID.

Example: Packet (a ->b) arrives at NPU1. NPU1 performs sanity checks and applies DoS screens to the packet. NPU1 checks its session table for a tuple match, and no existing session is found. NPU1 forwards the packet to an SPU.

Step 2. The Distributed Central Point Creates a Session with a "Pending" State.

When an NPU receives a packet, the NPU send it to the distributed central point, based on the hash algorithm. The distributed central point then looks up the distributed central point session table and creates an entry if needed.

This process entails the following parts:

1. The distributed central point checks its session table to determine if a session exists for the packet received from the NPU. (An NPU forwards a packet to the distributed central point because it cannot find an existing session for the packet)

2. If there is no entry that matches the packet in the distributed central point session table, the distributed central point creates a pending wing for the session. The distributed central point then sends a query message to the application central point to select an SPU to be used for the session.
3. On receiving the query message, the application central point checks its gate table to determine if a gate exists for the packet. If a gate is matched or some other session distribution algorithm is triggered, the application central point selects another SPU to process the packet; otherwise, the SPU (that is, the distributed central point SPU) is selected. Finally, the application central point sends a query response to the distributed central point.
4. On receiving the query response, the distributed central point forwards the first packet in flow to the selected SPU in a message directing the SPU to set up a session locally to be used for the packet flow. For example, the distributed central point creates a pending wing (a ->b) for the session. The application central point selects SPU1 to be used for it. The distributed central point sends SPU1 the (a->b) packet along with a message to create a session for the distributed central point.

Example: The distributed central point creates a pending wing (a ->b) for the session. It selects SPU1 to be used for it. It sends SPU1 the (a->b) packet along with a message to create a session for it.

Step 3. The SPU Sets Up the Session.

Each SPU, too, has a session table, which contains information about its sessions. When the SPU receives a message from the distributed central point to set up a session, it checks its session table to ensure that a session does not already exist for the packet.

1. If there is no existing session for the packet, the SPU sets up the session locally.
2. The SPU sends a message to the distributed central point directing it to install the session.

NOTE: During first-packet processing, if NAT is enabled, the SPU allocates IP address resources for NAT. In this case, the first-packet processing for the session is suspended until the NAT allocation process is completed.

The SPU adds to the queue any additional packets for the flow that it might receive until the session has been installed.

Example: SPU1 creates the session for (a ->b) and sends a message back to the distributed central point directing it to install the pending session.

Step 4. The Distributed Central Point Installs the Session.

The distributed central point receives the install message from the SPU.

1. The distributed central point sets the state for the session's pending wing to active.

2. The distributed central point installs the reverse wing for the session as an active wing.

NOTE: For some cases, such as NAT, the reverse wing may be installed on a different distributed central point from the init wing distributed central point.

3. It sends an acknowledge (ACK) message to the SPU, indicating that the session is installed.

Example: The distributed central point receives a message from SPU1 to install the session for the (a->b) wing. It sets the session state for the (a->b) wing to active. It installs the reverse wing (b->a) for the session and makes it active; this allows for delivery of packets from the reverse direction of the flow: destination (b) to be delivered to the source (a).

Step 5. The SPU Sets Up the Session on the Ingress and Egress NPUs.

NPUs maintain information about a session for packet forwarding and delivery. Session information is set up on the egress and ingress NPUs (which sometimes are the same) so that packets can be sent directly to the SPU that manages their flows and not to the distributed central point for redirection.

Step 6. Fast-Path Processing Takes Place.

For the remainder of the steps entailed in packet processing, proceed to Step 1 in "[Understanding Fast-Path Processing](#)" on page 25.

[Figure 6 on page 25](#) illustrates the first part of the process that the first packet in a flow undergoes after it reaches the device. At this point a session is set up to process the packet and the rest of the packets belonging to its flow. Subsequently, it and the rest of the packets in the flow undergo fast-path processing.

Figure 6: Session Creation: First-Packet Processing

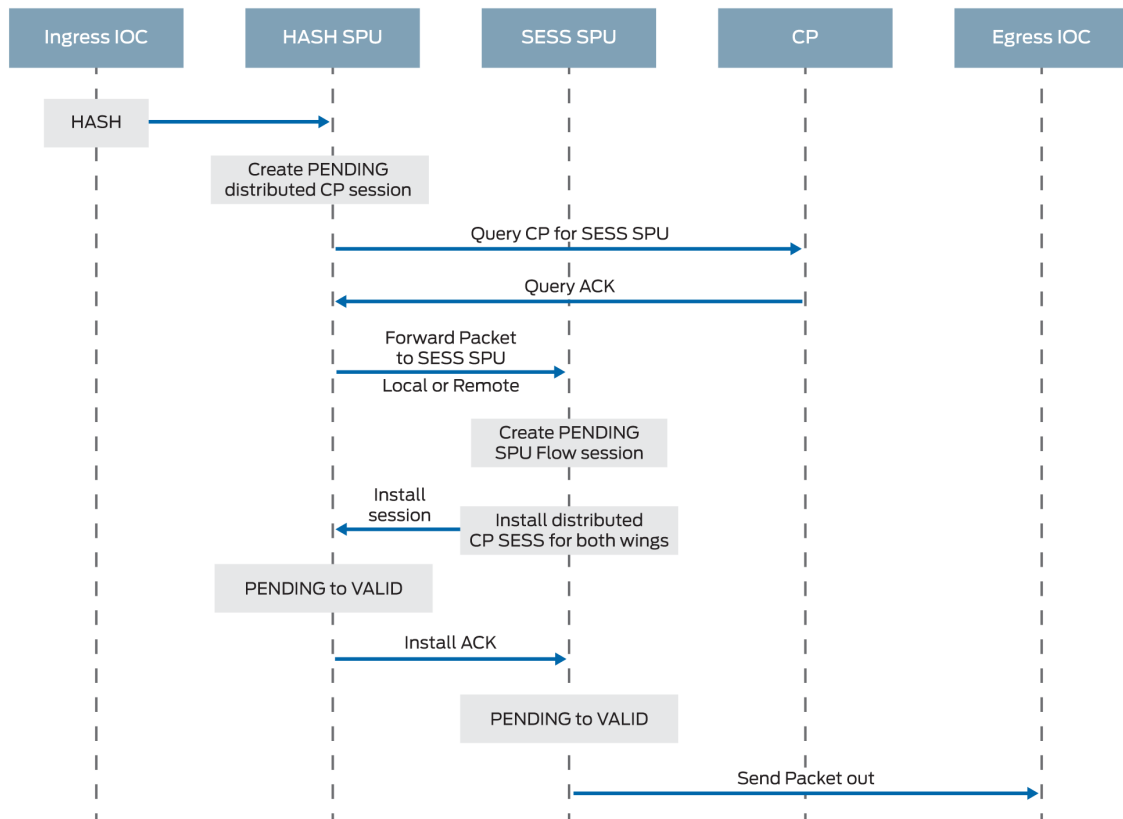

Understanding Fast-Path Processing

All packets undergo fast-path processing. However, if a session exists for a packet, the packet undergoes fast-path processing and bypasses the first-packet process. When there is already a session for the packet's flow, the packet does not transit the central point.

Here is how fast-path processing works: NPUs at the egress and ingress interfaces contain session tables that include the identification of the SPU that manages a packet's flow. Because the NPUs have this session information, all traffic for the flow, including reverse traffic, is sent directly to that SPU for processing.

To illustrate the fast-path process, this section uses an example with a source "a" and a destination "b". The direction from source to destination for the packets of the flow is referred to as (a->b). The direction from destination to source is referred to as (b->a).

Step 1. A Packet Arrives at the Device and the NPU Processes It.

This section describes how a packet is handled when it arrives at a services gateway's IOC.

1. The packet arrives at the device's IOC and is processed by the NPU on the card.

The NPU performs sanity checks and applies some screens, such as denial-of-service (DoS) screens, to the packet.

2. The NPU identifies an entry for an existing session in its session table that the packet matches.
3. The NPU forwards the packet along with metadata from its session table, including the session ID and packet tuple information, to the SPU that manages the session for the flow, applies stateless firewall filters and CoS features to its packets, and handles the packet's flow processing and application of security and other features.

Example: Packet (a ->b) arrives at NPU1. NPU1 performs sanity checks on the packet, applies DoS screens to it, and checks its session table for a tuple match. It finds a match and that a session exists for the packet on SPU1. NPU1 forwards the packet to SPU1 for processing.

Step 2. The SPU for the Session Processes the Packet.

Most of a packet's processing occurs on the SPU to which its session is assigned. The packet is processed for packet-based features such as stateless firewall filters, traffic shapers, and classifiers, if applicable. Configured flow-based security and related services such as firewall features, NAT, ALGs, and so on, are applied to the packet. (For information on how security services are determined for a session.

1. Before it processes the packet, the SPU checks its session table to verify that the packet belongs to one of its sessions.
2. The SPU processes the packet for applicable features and services.

Example: SPU1 receives packet (a->b) from NPU1. SPU1 checks its session table to verify that the packet belongs to one of its sessions. Then it processes packet (a ->b) according to input filters and CoS features that apply to its input interface. The SPU applies the security features and services that are configured for the packet's flow to it, based on its zone and policies. If any are configured, it applies output filters, traffic shapers and additional screens to the packet.

Step 3. The SPU Forwards the Packet to the NPU.

1. The SPU forwards the packet to the NPU.
2. The NPU applies any applicable screens associated with the interface to the packet.

Example: SPU1 forwards packet (a ->b) to NPU2, and NPU2 applies DoS screens.

Step 4. The Interface Transmits the Packet from the Device.

Example: The interface transmits packet (a->b) from the device.

Step 5. A Reverse Traffic Packet Arrives at the Egress Interface and the NPU Processes It.

This step mirrors Step 1 exactly in reverse. See Step 1 in this section for details.

Example: Packet (b->a) arrives at NPU2. NPU2 checks its session table for a tuple match. It finds a match and that a session exists for the packet on SPU1. NPU2 forwards the packet to SPU1 for processing.

Step 6. The SPU for the Session Processes the Reverse Traffic Packet.

This step is the same as Step 2 except that it applies to reverse traffic. See Step 2 in this section for details.

Example: SPU1 receives packet (b->a) from NPU2. It checks its session table to verify that the packet belongs to the session identified by NPU2. Then it applies packet-based features configured for the NPU1's interface to the packet. It processes packet (b->a) according to the security features and other services that are configured for its flow, based on its zone and policies.

Step 7. The SPU Forwards the Reverse Traffic Packet to the NPU.

This step is the same as Step 3 except that it applies to reverse traffic. See Step 3 in this section for details.

Example: SPU1 forwards packet (b->a) to NPU1. NPU1 processes any screens configured for the interface.

8. The Interface Transmits the Packet from the Device.

This step is the same as Step 4 except that it applies to reverse traffic. See Step 4 in this section for details.

Example: The interface transmits packet (b->a) from the device.

[Figure 7 on page 28](#) illustrates the process a packet undergoes when it reaches the device and a session exists for the flow that the packet belongs to.

Figure 7: Packet Walk for Fast-Path Processing

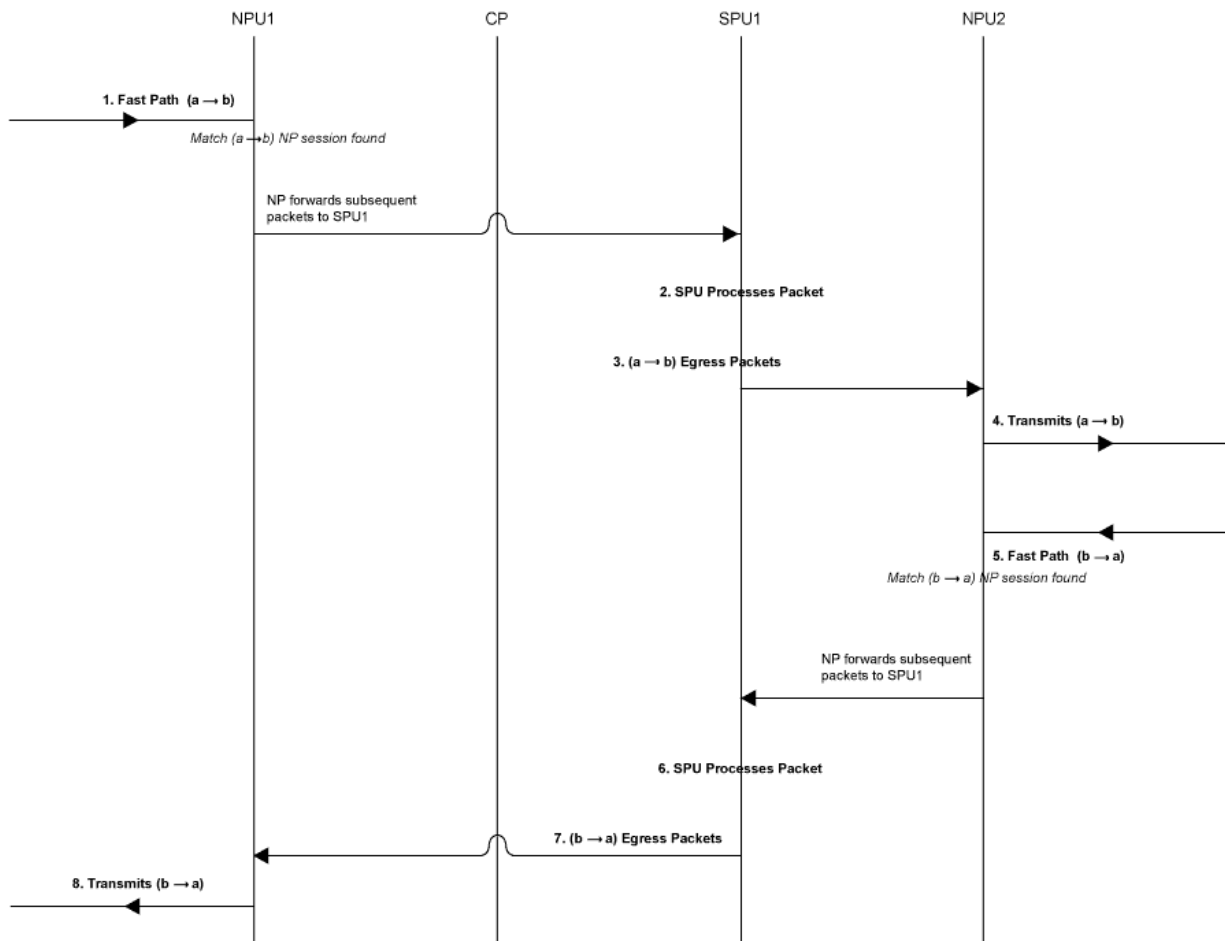

Understanding Services Processing Units

For a given physical interface, the SPU receives ingress packets from all network processors in the network processor bundle associated with the physical interface. The SPU extracts network processor bundle information from the physical interface and uses the same 5-tuple hash algorithm to map a flow to a network processor index. To determine the network processor, the SPU does a lookup on the network processor index in the network processor bundle. The SPU sends egress packets to the physical interface's local Physical Interface Module (PIM) for the outward traffic.

NOTE: The network processor and the SPU use the same 5-tuple hash algorithm to get the hash values for the packets.

Understanding Scheduler Characteristics

For SRX5400, SRX5600, and SRX5800 devices, the IOC supports the following hierarchical scheduler characteristics:

- IFL – The configuration of the network processor bundle is stored in the physical interface data structure. For example, SRX5400, SRX5600, and SRX5800 devices have a maximum of 48 PIMs. The physical interface can use a 48-bit bit-mask to indicate the PIM, or the network processor traffic from this physical interface is distributed in addition to the physical interface's primary network processor.

On SRX5000 line devices, the `iflset` functionality is not supported for aggregated interfaces like `reth`.

- IFD – The *logical interface* associated with the physical interface of a network processor bundle is passed to all the IOCs that have a PIM in the network processor bundle.

Understanding Network Processor Bundling

The network processor bundling feature is available on SRX5000 line devices. This feature enables distribution of data traffic from one interface to multiple network processors for packet processing. A primary network processor is assigned for an interface that receives the ingress traffic and distributes the packets to several other secondary network processors. A single network processor can act as a primary network processor or as a secondary network processor to multiple interfaces. A single network processor can join only one network processor bundle.

Network Processor Bundling Limitations

Network processor bundling functionality has the following limitations:

- Network processor bundling allows a total of 16 PIMs per bundle and 8 different network processor bundle systems.
- You need to reboot the device to apply the configuration changes on the bundle.
- Network processor bundling is below the `reth` interface in the overall architecture. You can choose one or both interfaces from the network processor bundle to form the `reth` interface.
- If the IOC is removed from a network processor bundle, the packets forwarded to the PIM on that IOC are lost.
- When the network processor bundle is enabled, the ICMP, UDP, and TCP sync flooding thresholds no longer apply to an interface. Packets are distributed to multiple network processors for processing. These thresholds apply to each network processor in the network processor bundle.
- Network processor bundling is not supported in Layer 2 mode.

- Because of memory constraints on the network processor, the number of network processor bundled ports that are supported per PIM is limited. Within the network processor bundle, each port needs to have a global port index. The global port index is calculated using the following formula:

$$\text{Global_port_index} = (\text{global_pic} * 16) + \text{port_offset}$$

- Link aggregation groups (LAGs) and redundant Ethernet interface LAGs in *chassis cluster* implementations can coexist with network processor bundling. However, neither LAGs nor redundant Ethernet interface LAGs can overlap with or share physical links with a network processor bundle.

Understanding Session Cache

IN THIS SECTION

- [Overview | 30](#)
- [Selective Session Cache Installation | 31](#)
- [IPsec VPN Session Affinity Enhancement Using Session Cache | 33](#)
- [Fragmentation Packet Ordering Using NP Session Cache | 33](#)

Overview

The SRX5K-MPC (IOC2), SRX5K-MPC3-100G10G (IOC3), and SRX5K-MPC3-40G10G (IOC3) on SRX5400, SRX5600, and SRX5800 devices support session cache and selective installation of the session cache.

Session cache is used to cache a conversation between the network processor (NP) and the SPU on an IOC. A conversation could be a session, GTP-U tunnel traffic, IPsec VPN tunnel traffic, and so on. A conversation has two session cache entries, one for incoming traffic and the other for reverse traffic. Depending on where the traffic ingress and egress ports are, two entries might reside in the same network processor or in different network processors. IOCs support session cache for IPv6 sessions.

A session cache entry is also called a *session wing*.

Session cache on the IOC leverages Express Path (formerly known as *services offloading*) functionality and helps prevent issues such as high latency and IPsec performance drop.

A session cache entry records:

- To which SPU the traffic of the conversion should be forwarded
- To which egress port the traffic of the conversion should be forwarded in Express Path mode
- What processing to do for egress traffic, for example, NAT translation in Express Path mode

Starting with Junos OS Release 15.1X49-D10 and Junos OS Release 17.3R1, the session cache of the sessions in the IOC helps to solve certain performance issues. The SPU can now instruct the IOC session cache to forward subsequent traffic to a specific anchor SPU.

Starting with Junos OS Release 15.1X49-D10, the SRX5K-MPC (IOC2) and the IOC3 support VPN session affinity through improved flow module and session cache. Starting in Junos OS Release 12.3X48-D30, on the IOC2, VPN session affinity through session cache is supported.

Other traffic was hashed to SPUs based on their 5-tuple key information. VPN traffic employed the concept of the anchored SPU, which did not necessarily coincide with the functions of the flow SPU. The network processor could only forward the packets to the flow SPU based on the 5-tuple hash. The flow SPU then forwarded the packet to the anchored SPU. This created an extra hop for VPN traffic, which wasted the switch fabric bandwidth and reduced the VPN throughput roughly by half. This performance reduction occurred because the traffic still had to go back to the flow SPU after processing on the anchored SPU.

The session cache table is now extended on IOC to support the NP sessions. Express Path traffic and NP traffic share the same session cache table on IOCs. Express Path traffic is forwarded by the IOC itself either locally or to another IOC, because the traffic does not require any services from the SPU. NP traffic is forwarded to the SPU specified in the session cache for further processing. All the session cache entries are shared by both Express Path session traffic and NP traffic.

To enable session cache on the IOCs you need to run the `set chassis fpc <fpc-slot> np-cache` command.

NOTE: The IOC2 and the IOC3 utilize the delay sessions delete mechanism. The same sessions (sessions with the same five tuples) that are deleted and then reinstalled immediately are not cached on the IOCs.

Selective Session Cache Installation

To avoid high latency, improve IPSec performance, and to better utilize the valuable resources, certain priority mechanisms are applied to both flow module and the IOC.

The IOCs maintain and monitor session cache usage threshold levels. The IOCs also communicate the session cache usage to the SPU, so that when a certain session cache usage threshold is reached, the SPU only sends session cache installation requests for selective high-priority traffic sessions.

Applications like IDP, ALG need to process packets in order. One SPU has multiple flow threads to handle packets belong to one session, load balancing thread (LBT), and packet-ordering thread (POT) packet order can make sure traffic pass through firewall in order, it cannot guarantee application to process packets that belong to same session in order. Flow serialization provides the method that only one SPU flow thread processing packets belong to the same session at one time, so applications can receive, process and send out packet in order. Other flow threads can do flow serialization processing for other sessions at the same time.

The following four priority levels are used to determine which type of traffic can install session cache on the IOCs:

- **Priority 1 (P1)**– IPsec and Express Path qualified traffic
- **Priority 2 (P2)**– Fragmentation ordering
- **Priority 3 (P3)**– NAT/SZ (Session serialization) traffic traffic
- **Priority 4(P3)**– All other types of traffic

The IOCs maintain and monitor the threshold levels for session cache usage and update the current real-time session cache usage to the SPU. The SPU requests the IOC to install the session cache for certain high-priority traffic sessions. Session cache usage for high-priority traffic sessions is defined in table:

Table 1: Session Cache Installation Bars

Traffic Type	0% < utilization < 25%	25% < utilization < 50%	50% < utilization < 75%	75% < utilization < 100%
IPsec and Express Path traffic	Yes	Yes	Yes	Yes
Fragmentation Ordering traffic	Yes	Yes	Yes	No
NAT/SZ traffic	Yes	Yes	No	No
Other traffic	Yes	No	No	No

To conserve session entries on the IOC, the flow module selectively installs sessions on the IOC. To facilitate the session install selection, the IOC maintains corresponding thresholds to provide an indication to the flow module (on how full the session cache table is on the IOCs). Two bits in the meta header are added to indicate the current cache table utilization status. All packets going to the SPU will carry these two status bits to inform the flow module of the utilization of the cache table on the IOC.

IPsec VPN Session Affinity Enhancement Using Session Cache

SRX Series Firewalls are fully distributed systems, and an IPsec tunnel is allocated and anchored to a specific SPU. All the traffic that belongs to an IPsec tunnel is encrypted and decrypted on its tunnel-anchored SPU. In order to achieve better IPsec performance, IOC improves the flow module to create sessions for IPsec tunnel-based traffic (before encryption and after decryption) on its tunnel-anchored SPU, and installs session cache for the sessions so that the IOC can redirect the packets directly to the same SPU to minimize packet-forwarding overhead. Express Path traffic and NP traffic share the same session cache table on IOCs.

You need to enable session cache on the IOCs and set the security policy to determine whether a session is for Express Path (formerly known as *services offloading*) mode on the selected Flexible PIC Concentrator (FPC).

To enable IPsec VPN affinity use, the `set security flow load-distribution session-affinity ipsec` command.

NOTE: To enable IPsec VPN affinity, you must also enable the session cache on IOCs by using the `set chassis fpc <fpc-slot> np-cache` command.

Fragmentation Packet Ordering Using NP Session Cache

A session might consist of both normal and fragmented packets. With hash-based distribution, 5-tuple and 3-tuple key can be used to distribute normal and fragmented packets to different SPUs, respectively. On SRX Series Firewalls, all the packets of the session are forwarded to a processing SPU. Due to forwarding and processing latency, the processing SPU might not guarantee packet ordering of the session.

Session cache on the IOCs ensure ordering of packets of a session with fragmented packets. A session cache entry is allocated for normal packets of the session and a 3-tuple key is used to find the fragmented packets. On receipt of the first fragmented packet of the session, the flow module allows the IOC to update the session cache entry to remember the fragmented packets for the SPU. Later, IOC forwards all subsequent packets of the session to the SPU to ensure ordering of packets of a session with fragmented packets.

Configuring IOC to NPC Mapping

An Input/Output card (IOC) to Network Processing Card (NPC) mapping requires you to map one IOC to one NPC. However, you can map multiple IOCs to a single NPC. To balance the processing power in the NPC on the SRX3400, and SRX3600 Services Gateways, the chassis process (daemon) runs an algorithm that performs the mapping. It maps an IOC to an NPC that has the least amount of IOCs mapped to it.

You can also use the command-line interface (CLI) to assign a specific IOC to a specific NPC. When you configure the mapping, the chassis process will first use your configuration, then apply the least-number NPC algorithm for the rest of the IOCs.

NOTE: Platform support depends on the Junos OS release in your installation.

To configure the IOC to NPC mapping:

```
[edit]
set chassis ioc-npc-connectivity {
  ioc slot-number npc (none | slot-number);
}
```

See [Table 2 on page 34](#) for a description of the `set chassis ioc-npc-connectivity` options.

Table 2: IOC to NPC Connectivity Options

Option	Description
<i>ioc slot-number</i>	Specify the IOC slot number. Range is 0 through 7 for SRX3400 devices and 0 through 12 for SRX3600 devices.
<i>npc slot-number</i>	Specify the NPC slot number. Range is 0 through 7 for SRX3400 devices and 0 through 12 for SRX3600 and SRX 4600 devices.
none	The chassis process maps the connection for the particular IOC.

NOTE: You must restart the chassis control after you commit the `set chassis ioc-npc-connectivity` command.

Understanding Flow Processing on SRX5K-SPC3 Devices

IN THIS SECTION

- [Understanding SPC3 Software Architecture](#) | 36
- [Understanding Load Distribution](#) | 38
- [Understanding NP Session and Service Offload \(SOF\)](#) | 40
- [Understanding J-Flow support on SPC3](#) | 40
- [Understanding Datapath Debug SPU Support \(E2E\)](#) | 40
- [Understanding Fragmentation Handling, ISSU, and ISHU Support](#) | 41

The service processing card SRX5K-SPC3 is introduced to improve the performance of security services on the SRX5000 security services gateway. The SPC3 card supports higher throughput, maintains its reliability as it preserves the chassis cluster functionality and scalability for service processing.

The SPC3 card provides support for the following security features:

- Application layer gateway (ALG). [See [ALG Overview](#)]
- Advanced anti-malware (Juniper ATP Cloud). [See [Juniper Sky Advanced Threat Prevention Administration](#)]
- Application security suite. [See [Application Security User Guide for Security Devices](#)]
- Flow-based packet processing implementation
- GPRS tunneling protocol (GTP) and stream control transmission protocol (SCTP). [See [General Packet Radio Service User Guide for Security Devices](#)]
- High availability (chassis cluster). [See [Chassis Cluster User Guide for SRX Series Devices](#)]
- Intrusion detection and prevention (IDP). [See [Intrusion Detection and Prevention Overview](#)]
- Network address translation (NAT). [See [Network Address Translation User Guide for Security Devices](#)]
- Stateful firewall
- SSL proxy. [See [SSL Proxy](#)]
- Firewall user authentication. [See [Authentication and Integrated User Firewalls User Guide for Security Devices](#)]

- Content Security (antivirus, web filtering, content filtering, and antispam). [See [UTM User Guide for Security Devices](#)]

The security flow is enhanced to support SPC3 card with all the existing security features that are supported on the SPC2 card.

NOTE: The following limitations apply for the SPC3 card in Junos OS Release 18.2R1-S1:

- Interoperability of SPC3 card and SPC2 card is not supported.
- IPsec VPN functionality is not supported with SPC3 card.

Starting in Junos OS Release 18.2R1-S1, a new service processing card (SPC3) is introduced for the SRX5000 line devices. The introduction of the new card improves the scalability and performance of the device and maintains its reliability as it preserves the chassis cluster functionality. The SPC3 card supports higher throughput and scalability for service processing.

On SRX5000 line devices, SPC3 card interoperates with I/O cards (IOC2, IOC3), Switch Control Board (SCB2, SCB3), Routing Engines and SPC2 cards.

Starting in Junos OS Release 18.4R1, a mix of of SPC3 and SPC2 cards is supported on SRX5000 line devices.

If you are adding the SPC3 cards on SRX5000 line of devices, the new SPC3 card must installed in the lowest-numbered slot of any SPC. The SPC3 card is installed in the original lowest-numbered slot provides the central point (CP) functionality in mixed-mode.

For example, if your services gateway contains a mix of SPC2 and SPC3 cards, an SPC3 must occupy the lowest-numbered slot of any SPC in the chassis. This configuration ensures that the central point (CP) functionality in mixed-mode is performed by the SPC3 card.

On SRX5000 line devices operating in mixed-mode, flow processing is shared between SPC3 and SPC2 cards. Central Point processing takes place on the lowest number SPC slot for which an SPC3 card is installed.

NOTE: When SRX Series Firewalls are operating in a chassis cluster mode, SPC3 and SPC2 cards must be installed in the same slot locations on each chassis.

Understanding SPC3 Software Architecture

SPC3 flow architecture is same as CP-Lite architecture. The SPC3 physically has two Services Processing Units (SPU) and each SPU has two CPUs.

When you install one or two SPC3s, traffic processing utilizes 75% of the first SPC. When you install three or more SPC3s, the traffic processing utilizes 50% of the first SPC.

The way the IOC hashes the packets to process the flow is changed. Figure shows the packet flow of SRX Series Firewall with SPC3.

Figure 8: Packet flow on SPC3

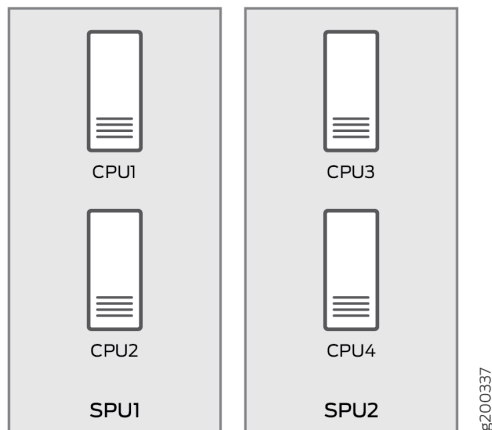

On SPC3, packets are distributed from IOC to each core directly. Since the IOC directly hashes packets to the flowd RT thread, the original LBT thread is removed. The packets are now delivered to the flowd thread instead of SPU. If the security flow installs NP sessions, instead of SPU ID, the session thread ID is used by IOC to forward packets to correct thread associate with the session.

Figure 9: Packet flow through flowd thread

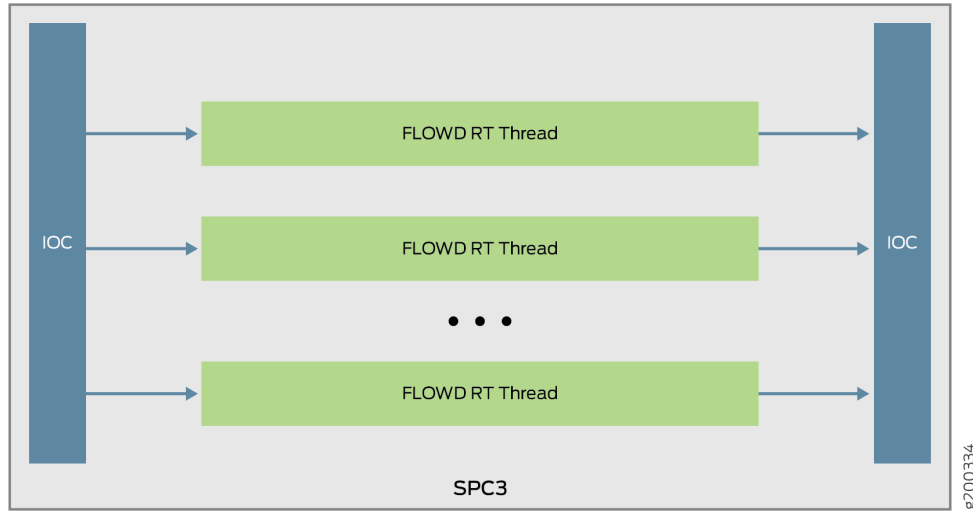

Understanding Load Distribution

All packets that come through a revenue port will be distributed to different SPUs based on hash algorithm, which is same as the existing SRX5000 Line devices hash based on CP-Lite architecture. The hash method varies for different types of traffic. The table below lists hash methods.

Table 3: Load Distribution - Hash Methods

Protocol		Ports	Hash Method
TCP		L4 src port and dst port	Hashed by 5-tuple
UDP	Normal	L4 src port and dst port	Hashed by 5-tuple
	GTP	L4 src port and dst port	Hashed by 5-tuple
	IKE	L4 src port and dst port	Hashed by IP pair

Table 3: Load Distribution - Hash Methods (Continued)

Protocol	Ports	Hash Method
ICMP	<ol style="list-style-type: none"> 1. ICMP version 4 info message ICMP_ECHO/ICM_ECHOREPLY id/seq ICMP_TSTAMP/ICMP_TSTAMPREPLY id/seq ICMP_IREQ/ICMP_IREQREPLY id/seq ICMP_MASKREQ/ ICMP_MASKREPLY 0x00010001 2. ICMP version 6 info message ICMP6_ECHO_REPLY/ ICMP6_ECHO_REQUEST id/seq 3. ICMP error message Match by embedded IP 4. All others 0x00010001 	<p>ICMP info is hashed by 5-tuple;</p> <p>ICMP error is hashed by 3-tuple (no ports info)</p>
SCTP	L4 src port and dst port	Hashed by 5-tuple
ESP	SPI	Hashed by IP pair
AH	SPI	Hashed by IP pair
GRE	<p>If PPTP alg is enabled, sport = call id; dport = 0</p> <p>By default, port is 0x00010001</p>	Hashed by 3-tuple
PIM	By default, PIM ports 0x00010001	Hashed by 3-tuple
FRAGMENT	<p>First fragment, has the normal ports</p> <p>None first fragment, no ports</p>	Hashed by 3-tuple
Other IP packet	Ports 0x00010001	Hashed by 3-tuple

Table 3: Load Distribution - Hash Methods (Continued)

Protocol	Ports	Hash Method
NONE IP	Not applicable	Hashed by Mac address and Ethernet Type (Vlan ID)

Understanding NP Session and Service Offload (SOF)

Network processor (NP) session is an IOC-based session that allows and establishes the SPU sessions. The packets that pass the NP session has the following advantages:

- Avoids session lookup on SPU to gain better performance.
- Avoids extra packet forwarding between session SPU and hash SPU.

Service offload is a special type of NP session to provide low-latency feature for session that needs basic firewall service. Packets that hits the SOF session on an IOC bypass the packet processing on SPU and is directly forwarded by IOC. The following traffic types support service offload:

- Basic firewall (without plugin and fragments), IPv4 and IPv6 TCP, UDP traffic
- IPv4 NAT
- 1Fan-in and 1Fan-out Multicast
- ALGs such as FTP data session

Understanding J-Flow support on SPC3

J-Flow is the juniper version of industry standard traffic monitoring mechanism. It provides a feature to export snapshot of network traffic statistics to the remote server for network monitoring and further data processing. J-Flow supports v5, v8 and v9 format. All these three versions are supported on SPC3.

Understanding Datapath Debug SPU Support (E2E)

Datapath debug provides filter based end-to-end (E2E) packet debug feature on SRX5000 Line devices. It traces packet path and dump packet content.

On SPC3, JEXEC is the only E2E event type that is supported and the following E2E action types are supported:

- Count
- Dump

- Trace
- Trace-summary

Understanding Fragmentation Handling, ISSU, and ISHU Support

On SPC3, fragmented packets are forwarded to “fragment core” in a specific PFE based on its header tuple values. After receiving a fragmented packet, flow performs defragmentation and forwards the packet to its session core. The flow logic does not change and remains the same.

While performing the ISSU, the virtual SPUs are synchronized to related virtual SPU IDs. The ISHU support is based on CP-Lite architecture. Basically, two ISHU operations are supported:

- Insert a new SPC to secondary node.
- Replace an SPC on secondary node, and the number of SPCs should be same as that of primary node.

RELATED DOCUMENTATION

Understanding SRX Series Firewalls Central Point Architecture

Configuring Inline J-Flow to Use IPFIX Flow Templates on MX, vMX and T Series Routers, EX Series Switches, NFX Series Devices, and SRX Devices

Release History Table

Release	Description
18.4R1	Starting in Junos OS Release 18.4R1, a mix of of SPC3 and SPC2 cards is supported on SRX5000 line devices.
18.2R1-S1	Starting in Junos OS Release 18.2R1-S1, a new service processing card (SPC3) is introduced for the SRX5000 line devices. The introduction of the new card improves the scalability and performance of the device and maintains its reliability as it preserves the chassis cluster functionality. The SPC3 card supports higher throughput and scalability for service processing.
15.1X49-D70	By default, the SRX Series Firewall is enabled for flow-based forwarding for IPv4 traffic on all devices, apart from the SRX300 Series and SRX550M devices that are set to drop mode. Starting with Junos OS Release 15.1X49-D70 and Junos OS Release 17.3R1, for the SRX1500 series, SRX4100, SRX4200, SRX5400, SRX5600, SRX5800 and vSRX Virtual Firewall devices, you do <i>not</i> need to reboot the device when you are switching modes between flow mode, packet mode, and drop mode. For SRX300 Series and SRX550M devices, you <i>must</i> reboot the device when switching between flow mode, packet mode, and drop mode.
15.1X49-D10	Starting with Junos OS Release 15.1X49-D10 and Junos OS Release 17.3R1, the session cache of the sessions in the IOC helps to solve certain performance issues.

15.1X49-D10	Starting with Junos OS Release 15.1X49-D10, the SRX5K-MPC (IOC2) and the IOC3 support VPN session affinity through improved flow module and session cache
12.1X48-D30	Starting in Junos OS Release 12.3X48-D30, on the IOC2, VPN session affinity through session cache is supported

Central Point Architecture in Security Devices Overview

IN THIS SECTION

- [Understanding SRX Series Firewalls Central Point Architecture | 42](#)
- [Understanding Enhancements to Central Point Architecture for the SRX5000 Line | 46](#)
- [Understanding Central Point Architecture Flow Support for GTP and SCTP | 48](#)

The central point delegates the session processing to one of the SPUs. When a session is not established, the central point selects an SPU to establish the session for the flow, based on load-balancing criteria. If the session already exists, the central point forwards packets for that flow to the SPU hosting it.

Understanding SRX Series Firewalls Central Point Architecture

IN THIS SECTION

- [Load Distribution in mixed Mode | 44](#)
- [Sharing Processing Power and Memory in mixed Mode | 45](#)

The central point (CP) architecture has two basic flow functionalities: load balancing and traffic identification (global session matching). As described in this topic, the central point architecture is implemented either in centric mode, in which all session distribution and session matching is performed by the central point, or in mixed-mode, in which a percentage of Services Processing Unit (SPU) is dedicated to performing the central point functionality.

The central point's main function is to delegate session processing to one of the SPUs. If the session has not yet been established, the central point selects an SPU to establish the session for the flow, based on load-balancing criteria. If the session already exists, the central point forwards packets for that flow to the SPU hosting it. It also redirects packets to the correct SPU in the event that the NPU fails to do so.

The central point maintains a global session table with information about the owner SPU of a particular session. It functions as a central repository and resource manager for the whole system.

NOTE: The central point architecture is also implemented in CP-lite mode in which session management is offloaded from the central point to SPUs for performance and session scaling improvement. CP-lite is not discussed in this topic.

The SRX Series Firewall type in conjunction with the Junos OS release determine which mode is supported.

Table 4 on page 43 identifies the central point architecture implementation that is supported on SRX Series Firewalls for various releases.

Table 4: Central Point Implementation on SRX Series Devices in Conjunction With Junos OS Releases

	Mode Supported on SRX1400	Mode Supported On SRX3000 line	Mode Supported on SRX5000 line
Junos OS Release 12.3X48 and Previous Releases	<ul style="list-style-type: none"> • CP centric • mixed-mode 	<ul style="list-style-type: none"> • CP centric • mixed-mode 	<ul style="list-style-type: none"> • CP centric • mixed-mode
<ul style="list-style-type: none"> • Junos OS Release 15.1X49-D10 • Junos OS Release 15.1X49-D15 • Junos OS Release 15.1X49-D20 	These SRX Series Firewalls are no longer supported.	These SRX Series Firewalls are no longer supported.	<ul style="list-style-type: none"> • CP centric <p>NOTE: NG-SPC renders combo mode obsolete.</p>

Table 4: Central Point Implementation on SRX Series Devices in Conjunction With Junos OS Releases (Continued)

	Mode Supported on SRX1400	Mode Supported On SRX3000 line	Mode Supported on SRX5000 line
Junos OS Release 15.1X49-D30 and later releases	These SRX Series Firewalls are no longer supported.	These SRX Series Firewalls are no longer supported.	<ul style="list-style-type: none"> • CP-lite <p>NOTE: NG-SPC renders mixed-mode obsolete.</p>

The central point forwards a packet to its Services Processing Unit (SPU) upon session matching, or distributes traffic to an SPU for security processing if the packet does not match any existing session. The central point architecture is implemented in CP centric mode, in which all session distribution and session matching is performed by the CP or in combo mode

On some SRX Series Firewalls, an entire SPU cannot be dedicated for central point functionality, but a certain percentage of the SPU is automatically allocated for central point functionality and the rest is allocated for normal flow processing. When an SPU performs the function of central point as well as normal flow processing, it is said to be in combination, or *mixed*, mode.

The percentage of SPU dedicated to the central point functionality depends on the number of SPUs in the device. Based on the number of SPUs, there are three modes available on the SRX Series Firewalls—small central point, medium central point, and large central point.

In small central point mode, a small percentage of an SPU is dedicated to central point functionality and the rest is dedicated to the normal flow processing. In medium central point mode, an SPU is almost equally shared for central point functionality and normal flow processing. In large central point mode, an entire SPU is dedicated to central point functionality. In mixed-mode, the central point and SPU share the same load-balancing thread (LBT) and packet-ordering thread (POT) infrastructure.

This topic includes the following sections:

Load Distribution in mixed Mode

The central point maintains SPU mapping table (for load distribution) that lists live SPUs with the logic SPU IDs mapped to the physical Trivial Network Protocol (TNP) addresses mapping. In mixed-mode, the SPU that hosts the central point is included in the table. The load distribution algorithm is adjusted based on session capacity and processing power to avoid overloading of sessions.

Sharing Processing Power and Memory in mixed Mode

The CPU processing power in a mixed-mode SPU is shared based on the platform and the number of SPUs in the system. Similarly, the CPU memory is also shared between the central point and SPU.

An SPU has multiple cores (CPUs) for networking processing. In "small" SPU mixed-mode, CPU functionality takes a small portion of the cores, whereas "medium" SPU mixed-mode requires a larger portion of cores. The processing power for central point functionalities and flow processing is shared, based on the number of Services Processing Cards (SPC), as shown in [Table 5 on page 45](#). Platform support depends on the Junos OS release in your installation.

Table 5: mixed Mode Processing

SRX Series Firewall	Central point mode with 1 SPC or SPC2	Central point mode with 2 or more SPCs or SPC2s	Central point mode with 1 or 2 SPC3s	Central point mode with more than 2 SPC3s
SRX1400	Small	Medium	NA	NA
SRX3400	Small	Medium	NA	NA
SRX3600	Small	Medium	NA	NA
SRX3400 (expanded performance and capacity license)	Small	Large	NA	NA
SRX3600 (expanded performance and capacity license)	Small	Large	NA	NA
SRX5600	Large	Large	Medium	Large
SRX5800	Large	Large	Medium	Large
SRX5400	Large	Large	Medium	Large

NOTE: The mixed-mode processing only exists with SPCI on SRX1400, SRX3400, SRX3600, and SRX5000 line devices.

Understanding Enhancements to Central Point Architecture for the SRX5000 Line

IN THIS SECTION

- [Understanding Central Point Session Limit Performance Enhancements | 47](#)

Previously, for the SRX5000 line of services gateways, the central point was a bottleneck in device performance and scaling. When more Services Processing Cards (SPCs) were integrated into the system, the overall processing power increased linearly, but the system connections per second (cps) remained constant and could not be improved because of the single centralized point in the system. This severely impacted the overall system utilizations in both capacity and cps.

Starting with Junos OS Release 15.1X49-D30 and Junos OS Release 17.3R1, on SRX5000 line devices, the central point architecture is enhanced to handle higher connections per second (cps). The new central point architecture prevents data packets from going through the central point by off-loading session management functionalists to the Services Processing Unit (SPU). Therefore, data packets are directly forwarded from the network processing unit to the SPU instead of going through the central point.

The central point architecture is divided into two modules, the application central point and the distributed central point. The application central point is responsible for global resource management and loading balancing, while the distributed central point is responsible for traffic identification (global session matching). The application central point functionality runs on the dedicated central point SPU, while the distributed central point functionality is distributed to the rest of the SPUs. Now the central point sessions are no longer on the dedicated central point SPU, but with distributed central point on other flow SPUs.

NOTE: The central point for SRX5000 line refers to the application central point, or the distributed central point or both, with respect to global resource management and load

balancing, it refers to the application central point, whereas with respect to traffic identification and session management, it refers to the distributed central point (sometimes referred to the SPU as well).

NOTE: The SNMP log and SNMP trap were generated by the central point with rate limit. Now, the SNMP log and SNMP trap are generated by the SPU or central point. As there is more than one SPU, the number of SNMP log and traps generated are more. To verify the number of connections per second (CPS) on the device run `SNMP MIB walk nxJsNodeSessionCreationPerSecond` command. The SNMP polling mechanism calculates the CPS value based on the average number of CPS in the past 96 seconds. So, if the CPS is not constant, the number of CPS reported is inaccurate.

Understanding Central Point Session Limit Performance Enhancements

Starting in Junos OS 15.1X49-D70 and Junos OS Release 17.3R1, a new session connection (conn-tag) tag option is available to allow you to add a flow filter to further distinguish GRPS tunneling protocol, user plane (GTP-U) flow sessions and Stream Control Transmission Protocol (SCTP) flow sessions.

The flow session connection tuple consists of a 32-bit connection tag that is used to uniquely identify GTP-U sessions and SCTP sessions that are not distinguishable by the six part tuple only. You can configure the system to include the session connection tag tuple to identify GTP-U sessions and SCTP sessions by adding the session connection tag to the standard six tuples that identify a session. The system determines the DCP for GTP-U/SCTP by hashing the session connection tag.

The central point architecture distributes GTP-U traffic handled by a gateway GPRS support node (GGSN) and SGSN pair on all SPUs by switching to tunnel endpoint identifier (TEID)-based hash distribution. To handle load-balancing issues, tag-based hash distribution is used to ensure even distribution of SCTP traffic from different associations among all SPUs. (The connection tag for GTP-U is the TEID and for SCTP is the vTag.)

Understanding Central Point Architecture Flow Support for GTP and SCTP

IN THIS SECTION

- [Understanding the Flow Session Connection Filter Option | 50](#)

Starting in Junos OS Release 15.1X49-D40 and Junos OS Release 17.3R1, the central point architecture provides enhanced support for GPRS tunneling protocol, control (GTP-C), GPRS tunneling protocol, user plane (GTP-U), and Stream Control Transmission Protocol (SCTP).

The central point architecture, which is supported on the SRX5400, SRX5600, and SRX5800 devices, is enhanced to address the GTP-C message rate-limiting to protect gateway GPRS support node (GGSN) from GTP-C message flood, to prevent GTP-C packet drop issues during SGSN handover, and to distribute GTP-U traffic handled by a GGSN and SGSN pair on all SPUs by switching to tunnel endpoint identifier (TEID)-based hash distribution. Use the `enable-gtpu-distribution` command to enable or disable GTP-U session distribution. By default, the `enable-gtpu-distribution` command is disabled.

Connection-tag to flow session tuple is introduced to resolve GTP/SCTP load balance issue. All session including Distributed CP (DCP) session and SPU session are modified to accommodate connection-tag. The session creation have following tuple: `src-ip`, `dst-ip`, `src-port`, `dst-port`, `protocol`, `session-token` and `connection tag`.

The GTP ALG requires GTP-C sessions to be fixed by hashing GGSN IP addresses. The GTP ALG deny GTP-C session creation if the first packet is of uncertain direction, which will cause packet drop. To prevent the GTP-C packets from being dropped, a new flow session is created and the GTP-C traffic is allowed to pass even if the GGSN or SGSN direction is not determined. Later, the GGSN IP is determined using the correct SPU to create the flow session and age out the old session. The intermittent packets hitting the old session will be forwarded to the new SPU and be processed on the new session.

To handle load-balancing issues, tag-based hash distribution is used to ensure even distribution of GTP-U/SCTP traffic among all SPUs. A 32-bit connection tag is introduced that uniquely identifies the GTP-U and the SCTP sessions. The connection tag for GTP-U is the TEID and for SCTP is the `vTag`. The default connection-tag is 0. The connection tag remains 0 if it is not used by the sessions. Flow will determine connection tag for GTP-U/SCTP sessions and distribute them by hashing connection tag.

A SCTP association is a connection between two SCTP endpoints. Each SCTP endpoint identifies the association with a tag. During association setup (4-way handshakes), two SCTP endpoints exchange their own tags for packet receiving. During 4-way handshake, the receiver of INIT/INIT-ACK records the

value of itag, and places into the vtag field of every SCTP packet that transmit within this association. Then the peer uses the vtag to validate the sender of this packet.

Flow sessions created after CP-Lite as follows:

SPU is selected by hash(tag), the Client to Server traffic is handled on hash (tagB) SPU then forwarded to hash (tagA) SPU. Server to Client traffic is handled on hash (tagA) SPU directly.

1. After receive INIT packet, on hash (tagA) SPU:

DCP-session A1: client=> server, SCTP, Conn ID: 0x0;

Session A1: client=> server, SCTP, Conn ID: 0x0;

On hash (tagB) SPU: no session.

2. After receive INIT-ACK packet, on hash (tagA) SPU:

DCP-session A1: client=> server, SCTP, Conn ID: 0x0;

DCP-session A2: server => client, SCTP, Conn ID: tagA;

Session A1: client=> server, SCTP, Conn ID: 0x0;

Session A2: server => client, SCTP, Conn ID: tagA;

On hash (tagB) SPU: no session.

3. After receive COOKIE-ECHO packet, on hash (tagA) SPU:

DCP-session A1: client=> server, SCTP, Conn ID: 0x0;

DCP-session A2: server => client, SCTP, Conn ID: tagA;

Session A1: client=> server, SCTP, Conn ID: 0x0;

Session A2: server => client, SCTP, Conn ID: tagA;

Session A3: client=> server, SCTP, Conn ID: tagB;

On hash (tagB) SPU:

DCP-session: client => server, SCTP, Conn ID: tag B

4. After receive COOKIE-ACK packet, flow sessions have no change.

5. After handshake succeeds, HEARBEAT will be send on all paths.

Understanding the Flow Session Connection Filter Option

Starting in Junos OS 15.1X49-D70 and Junos OS Release 17.3R1, a new session connection (conn-tag) tag option is available to allow you to add a flow filter to further distinguish GRPS tunneling protocol, user plane (GTP-U) flow sessions and Stream Control Transmission Protocol (SCTP) flow sessions.

The flow session connection tuple consists of a 32-bit connection tag that is used to uniquely identify GTP-U sessions and SCTP sessions that are not distinguishable by the six part tuple only. You can configure the system to include the session connection tag tuple to identify GTP-U sessions and SCTP sessions by adding the session connection tag to the standard six tuples that identify a session. The system determines the DCP for GTP-U/SCTP by hashing the session connection tag.

The central point architecture distributes GTP-U traffic handled by a gateway GPRS support node (GGSN) and SGSN pair on all SPUs by switching to tunnel endpoint identifier (TEID)-based hash distribution. To handle load-balancing issues, tag-based hash distribution is used to ensure even distribution of SCTP traffic from different associations among all SPUs. (The connection tag for GTP-U is the TEID and for SCTP is the vTag.)

Release History Table

Release	Description
15.1X49-D70	Starting in Junos OS 15.1X49-D70 and Junos OS Release 17.3R1, a new session connection (conn-tag) tag option is available to allow you to add a flow filter to further distinguish GRPS tunneling protocol, user plane (GTP-U) flow sessions and Stream Control Transmission Protocol (SCTP) flow sessions.
15.1X49-D70	Starting in Junos OS 15.1X49-D70 and Junos OS Release 17.3R1, a new session connection (conn-tag) tag option is available to allow you to add a flow filter to further distinguish GRPS tunneling protocol, user plane (GTP-U) flow sessions and Stream Control Transmission Protocol (SCTP) flow sessions.
15.1X49-D40	Starting in Junos OS Release 15.1X49-D40 and Junos OS Release 17.3R1, the central point architecture provides enhanced support for GPRS tunneling protocol, control (GTP-C), GPRS tunneling protocol, user plane (GTP-U), and Stream Control Transmission Protocol (SCTP).
15.1X49-D30	Starting with Junos OS Release 15.1X49-D30 and Junos OS Release 17.3R1, on SRX5000 line devices, the central point architecture is enhanced to handle higher connections per second (cps).

RELATED DOCUMENTATION

| [Flow-Based Sessions](#) | 52

2

CHAPTER

Flow-Based Sessions

[Flow-Based Sessions | 52](#)

[TCP Sessions | 59](#)

[ECMP Flow-Based Forwarding | 72](#)

[Flow-Based Performance | 83](#)

[Flow Distribution and Packet-Ordering | 87](#)

[PowerMode | 96](#)

[Unified Policies Support for Flow | 99](#)

[TAP Mode for Flow Sessions | 104](#)

[Flow Management in SRX Series Devices Using VRF Routing Instance | 108](#)

Flow-Based Sessions

IN THIS SECTION

- [Understanding Session Characteristics for SRX Series Firewalls | 52](#)
- [Example: Controlling Session Termination for SRX Series Firewalls | 54](#)
- [Clearing Sessions for SRX Series Services Gateways | 56](#)
- [Configuring the Timeout Value for Multicast Flow Sessions | 57](#)

The Junos OS caches the session information that is triggered by the first packet of the flow. The cached session is used by subsequent packets of that same flow and the reverse flow of that session using the flow module, which is integrated into the forwarding path.

Understanding Session Characteristics for SRX Series Firewalls

IN THIS SECTION

- [Understanding Aggressive Session Aging | 53](#)

Sessions are created, based on routing and other classification information, to store information and allocate resources for a flow. Sessions have characteristics, some of which you can change, such as when they are terminated. For example, you might want to ensure that a session table is never entirely full to protect against an attacker's attempt to flood the table and thereby prevent legitimate users from starting sessions.

Depending on the protocol and service, a session is programmed with a timeout value. For example, the default timeout for TCP is 1800 seconds. The default timeout for UDP is 60 seconds.

If no traffic uses the session before the service timeout, the session is aged out and freed to a common resource pool for reuse. You can affect the life of a session in the following ways:

- You can specify circumstances for terminating sessions by using any of the following methods:

- Age out sessions based on how full the session table is
- Set an explicit timeout for aging out TCP sessions
- Configure a TCP session to be invalidated when it receives a TCP RST (reset) message
- Configure the `fin-invalidate-session` statement to terminate sessions when either session endpoint sends a FIN(ish) message to its peer.

When the peer endpoint receives the packet with the FIN flag set, it sends an ACK(nowlege) message. Typically, tearing down a session using this method involves transmission of a pair of FIN-ACK messages from each session.

- You can configure sessions to accommodate other systems as follows:
 - Disable TCP packet security checks
 - Change the maximum segment size

Understanding Aggressive Session Aging

The session table is a limited resource for SRX Series Firewalls. If the session table is full, any new sessions will be rejected by the device.

The aggressive session-aging mechanism accelerates the session timeout process when the number of sessions in the session table exceeds the specified high-watermark threshold. This mechanism minimizes the likelihood that the SRX Series Firewalls will reject new sessions when the session table becomes full.

Configure the following parameters to perform aggressive session aging:

- *high-watermark*—The device performs aggressive session aging when the number of sessions in the session table exceeds the *high-watermark* threshold.
- *low-watermark*—The device exits aggressive session aging and returns to normal when the number of sessions in the session table dips below the *low-watermark* threshold.
- *early-ageout*—During aggressive session aging, the sessions with an age-out time lower than the *early-ageout* threshold are marked as invalid.

On SRX1400, SRX3400, SRX3600, SRX5600, and SRX5800 devices, the SPU checks the session table, locates the sessions for which the timeout value is lower than the early-ageout time value, and then marks them as invalid. (Platform support depends on the Junos OS release in your installation.)

Example: Controlling Session Termination for SRX Series Firewalls

IN THIS SECTION

- Requirements | 54
- Overview | 54
- Configuration | 55
- Verification | 56

This example shows how to terminate sessions for SRX Series Firewalls based on aging out after a certain period of time, or when the number of sessions in the session table is full or reaches a specified percentage. You specify a timeout value or the number of sessions in the session table.

Requirements

Before you begin, understand the circumstances for terminating sessions.

Overview

You can control session termination in certain situations—for example, after receiving a TCP FIN Close or receiving an RST message, when encountering ICMP errors for UDP, and when no matching traffic is received before the service timeout. When sessions are terminated, their resources are freed up for use by other sessions.

In this example, you configure the following circumstances to terminate the session:

- A timeout value of 20 seconds.

NOTE: The minimum value you can configure for TCP session initialization is 4 seconds. The default value is 20 seconds; if required you can set the TCP session initialization value to less than 20 seconds.

- An explicit timeout value of 280 seconds, which changes the TCP session timeout during the three-way handshake.

The command sets the initial TCP session timeout to 280 in the session table during the TCP three-way handshake. The timer is initiated when the first SYN packet is received, and reset with each packet during the three-way handshake. Once the three-way handshake is completed, the session

timeout is reset to the timeout defined by the specific application. If the timer expires before the three-way handshake is complete, the session is removed from the session table.

- Any session that receives a TCP RST (reset) message is invalidated.

Configuration

IN THIS SECTION

- [Procedure | 55](#)

Procedure

Step-by-Step Procedure

To control session termination for SRX Series Firewalls:

The following example requires you to navigate various levels in the configuration hierarchy. For instructions on how to do that, see *Using the CLI Editor in Configuration Mode* in the [CLI User Guide](#).

To control session termination for SRX Series Firewalls:

1. Specify an age-out value for the session.

```
[edit security flow]
user@host# set aging early-ageout 20
```

2. Configure an aging out value.

```
[edit security flow]
user@host# set tcp-session tcp-initial-timeout 280
```

3. Invalidate any session that receives a TCP RST message.

```
[edit security flow]
user@host# set tcp-session rst-invalidate-session
```

4. If you are done configuring the device, commit the configuration.

```
[edit ]
user@host# commit
```

Verification

To verify the configuration is working properly, enter the `show security flow` command.

Clearing Sessions for SRX Series Services Gateways

IN THIS SECTION

- [Terminating Sessions for SRX Series Services Gateways | 56](#)
- [Terminating a Specific Session for SRX Series Services Gateways | 57](#)
- [Using Filters to Specify the Sessions to Be Terminated for SRX Series Services Gateways | 57](#)

You can use the `clear` command to terminate sessions. You can clear all sessions, including sessions of a particular application type, sessions that use a specific destination port, sessions that use a specific interface or port, sessions that use a certain IP protocol, sessions that match a source prefix, and resource manager sessions.

Terminating Sessions for SRX Series Services Gateways

You can use the following command to terminate all sessions except tunnel and resource manager sessions. The command output shows the number of sessions cleared. Be aware that this command terminates the management session through which the `clear` command is issued.

```
user@host> clear security flow session all
```

Terminating a Specific Session for SRX Series Services Gateways

You can use the following command to terminate the session whose session ID you specify.

```
user@host> clear security flow session session-identifier 40000381
```

Using Filters to Specify the Sessions to Be Terminated for SRX Series Services Gateways

You can terminate one or more sessions based on the filter parameter you specify for the `clear` command. The following example uses the protocol as a filter.

```
user@host> clear security flow session protocol 89
```

Configuring the Timeout Value for Multicast Flow Sessions

You can configure the timeout value for multicast flow sessions by configuring a custom application and associating the application with a policy.

Multicast flow sessions have one template session and one or more leaf sessions. Because these sessions are linked together, they can have only one timeout value. The timeout value for multicast flow sessions is determined by considering the timeout values configured in the leaf session policies and the IP protocol timeout values. The highest of these timeout values is selected as the multicast flow session timeout.

If no leaf session timeout values are configured, the IP protocol timeout value is automatically used as the timeout value for the multicast flow session. The IP protocol timeout is the default and is not configurable.

Configuring leaf session timeouts can be especially helpful for multicast streams that have a longer packet interval than the default IP protocol timeout. For example, multicast streams with a packet interval of more than 60 seconds would experience premature aging-out of flow sessions and packet drops with the UDP timeout value, which is always 60 seconds. For such streams, you can configure a higher leaf session timeout value and prevent packet drop.

To set the leaf session timeout value, configure a custom application and associate the application with a policy:

1. Create a custom application, specify its properties, and specify bypassing the application type.

```
[edit]
user@host# edit applications application my-udp
```

```
[edit applications application my-udp]
user@host# set protocol udp
user@host# set destination-port 5000
user@host# set application-protocol ignore
```

2. Set the timeout value for the application protocol.

```
[edit applications application my-udp]
user@host# set inactivity-timeout 500
```

3. Create a policy.

```
[edit]
user@host# edit security policies from-zone vr-zone-1 to-zone junos-host policy my-policy
```

```
[edit security policies from-zone vr-zone-1 to-zone junos-host policy my-policy]
user@host# set match source-address 192.0.2.1
user@host# set match destination-address any
```

4. Associate the custom application (with the configured timeout) to the policy.

```
[edit security policies from-zone vr-zone-1 to-zone junos-host policy my-policy]
user@host# set match application my-udp
user@host# set then permit
```

5. If you are done configuring the device, commit the configuration.

```
[edit]
user@host# commit
```

6. To verify the updated session timeout value, enter the **show security flow session** command.

```

user@host> show security flow session destination-prefix 203.0.113.0

Session ID: 2363, Policy name: N/A, Timeout: 498, Valid
  In: 192.0.2.1/17767-->203.0.113.0/5000;udp, If: ge-0/0/1.0, Pkts:0, Bytes:0
  Out: 203.0.113.0/5000-->192.0.2.1/17767/17767;udp, If:.local..4, Pkts:0, Bytes:0

Session ID: 2364, Policy name: my-policy/4, Timeout: -1, Valid
  In: 192.0.2.1/17767-->203.0.113.0/5000;udp, If:ge-0/0/1.0, Pkts:1011, Bytes:258816
  Out: 203.0.113.0/5000-->192.0.2.1/17767;udp, If:ppe0.32769, Pkts:0, Bytes:0
Total sessions: 2

```

In this output, the session ID 2363 section displays a template session. A timeout value of 498 indicates that the template session timeout value is ticking down from the configured value of 500 seconds.

The session ID 2364 section displays a leaf session. The timeout value of -1 essentially indicates that the session will not age out unless the template session ages out.

In this example, the configured leaf session timeout value of 500 seconds is the highest timeout value and is accepted as the template session timeout value for the multicast flow session.

RELATED DOCUMENTATION

[ECMP Flow-Based Forwarding | 72](#)

[Flow-Based Performance | 83](#)

[Flow Distribution and Packet-Ordering | 87](#)

TCP Sessions

IN THIS SECTION

- [Understanding TCP Session Checks per Policy | 60](#)
- [Example: Configuring TCP Packet Security Checks Per Policy | 61](#)

- [Example: Disabling TCP Packet Security Checks for SRX Series Services Gateways | 63](#)
- [Example: Setting the Maximum Segment Size for All TCP Sessions for SRX Series Firewalls | 65](#)
- [TCP Out-of-State Packet Drop Logging Overview | 67](#)
- [Understanding How Preserving Incoming Fragmentation Characteristics Can Improve Throughput | 70](#)

To send data over TCP in a network, a three-way handshake session establishment process is followed. There is a process to start a session, and there is also a process to terminate the TCP session. This topic helps you to understand the process involved in processing a TCP session.

Understanding TCP Session Checks per Policy

IN THIS SECTION

- [Disabling TCP Packet Security Checks | 61](#)

By default, the TCP SYN check and sequence check options are enabled on all TCP sessions. The Junos operating system (Junos OS) performs the following operations during TCP sessions:

- Checks for SYN flags in the first packet of a session and rejects any TCP segments with non- SYN flags that attempt to initiate a session.
- Validates the TCP sequence numbers during stateful inspection.

The TCP session check per-policy feature enables you to configure SYN and sequence checks for each policy. Currently, the TCP options flags, no-sequence-check and no-syn-check, are available at a global level to control the behavior of services gateways. To support per-policy TCP options, the following two options are available:

- `sequence-check-required`: The `sequence-check-required` value overrides the global value `no-sequence-check`.
- `syn-check-required`: The `syn-check-required` value overrides the global value `no-syn-check`.

To configure per-policy TCP options, you must turn off the respective global options; otherwise, the commit check will fail. If global TCP options are disabled and SYN flood protection permits the first

packet, then the per-policy TCP options will control whether SYN and/or sequence checks are performed.

NOTE:

- The per-policy `syn-check-required` option will not override the behavior of the `set security flow tcp-session no-syn-check-in-tunnel` CLI command.
- Disabling the global SYN check reduces the effectiveness of the device in defending against packet flooding.



CAUTION: Disabling the global SYN check and enforcing the SYN check after policy search will greatly impact the number of packets that the router can process. This in turn will result in intense CPU operations. When you disable global SYN check and enable per-policy SYN check enforcement, you should be aware of this performance impact.

Disabling TCP Packet Security Checks

On an SRX Series Firewall, you can disable security checks on TCP packets to ensure interoperability with hosts and devices with faulty TCP implementations.

The `no-sequence-check` option disables TCP sequence checks. It also increases the throughput.

The `set security flow tcp-session no-sequence-check` command disables the TCP sequence checks on all TCP sessions in default or hash-based modes.

Example: Configuring TCP Packet Security Checks Per Policy

IN THIS SECTION

- [Requirements | 62](#)
- [Overview | 62](#)
- [Configuration | 62](#)
- [Verification | 63](#)

This example shows how to configure TCP packet security checks for each policy in the device.

Requirements

Before you begin, you must disable the `tcp options`, `tcp-syn-check`, and `tcp-sequence-check` that are configured at global level. .

Overview

The SYN and sequence check options are enabled by default on all TCP sessions. In environments that need to support large file transfers, or that run nonstandard applications, it might be necessary to configure sequence and sync checks differently for each policy. In this example, you configure sequence and sync check for policy `pol1`.

Configuration

IN THIS SECTION

- [Procedure | 62](#)

Procedure

Step-by-Step Procedure

To configure TCP packet security checks at the policy level:

1. Configure the checking for the TCP SYN bit before creating a session.

```
[edit]
user@host# set security policies from-zone Zone-A to-zone Zone-B policy pol1 then permit tcp-
options syn-check-required
```

2. Configure the checking for sequence numbers in TCP segments during stateful inspection.

```
[edit]
user@host# set security policies from-zone Zone-A to-zone Zone-B policy pol1 then permit tcp-
options sequence-check-required
```

3. If you are done configuring the device, commit the configuration.

```
[edit]  
user@host# commit
```

Verification

To verify that the configuration is working properly, enter the `show security policies detail` command.

Example: Disabling TCP Packet Security Checks for SRX Series Services Gateways

IN THIS SECTION

- [Requirements | 63](#)
- [Overview | 63](#)
- [Configuration | 64](#)
- [Verification | 64](#)

This example shows how to disable TCP packet security checks in the device.

Requirements

Before you begin, understand the circumstances for disabling TCP packet security checks. .

Overview

Junos OS provides a mechanism for disabling security checks on TCP packets to ensure interoperability with hosts and devices with faulty TCP implementations. During `no-SYN-check` the Junos OS does not look for the TCP SYN packet for session creation. `No-sequence-check` disables TCP sequence checking validation. Also, increases throughput. `SYN-check` and `sequence-check` are enabled by default. The `set security flow` command disables TCP SYN checks and TCP sequence checks on all TCP sessions thus reduces security. This may be required in scenarios with customers like big transfer files, or with applications that do not correctly work with standards.

Configuration

IN THIS SECTION

- Procedure | 64

Procedure

Step-by-Step Procedure

The following example requires you to navigate various levels in the configuration hierarchy. For instructions on how to do that, see *Using the CLI Editor in Configuration Mode* in the [CLI User Guide](#).

To disable TCP packet security checks:

1. Disable the checking of the TCP SYN bit before creating a session.

```
[edit security flow]
user@host# set tcp-session no-syn-check
```

2. Disable the checking of sequence numbers in TCP segments during stateful inspection.

```
[edit security flow]
user@host# set tcp-session no-sequence-check
```

3. If you are done configuring the device, commit the configuration.

```
[edit ]
user@host# commit
```

Verification

To verify the configuration is working properly, enter the `show security flow` command.

Example: Setting the Maximum Segment Size for All TCP Sessions for SRX Series Firewalls

IN THIS SECTION

- Requirements | 65
- Overview | 65
- Configuration | 66
- Verification | 67

This example shows how to set the maximum segment size for all TCP sessions for SRX Series Firewalls.

Requirements

Before you begin, understand the circumstances for setting the maximum segment size.

Overview

You can terminate all TCP sessions by changing the TCP maximum segment size (TCP-MSS). To diminish the likelihood of fragmentation and to protect against packet loss, you can use the `tcp-mss` to specify a lower TCP MSS value. This applies to all TCP SYN packets traversing the router's ingress interfaces whose MSS value is higher than the one you specify.

If the DF bit is set, it will not fragment the packet and Junos OS will send ICMP error type 3 code 4 packet to the application server (Destination Unreachable; Fragmentation Needed and DF set). This ICMP error message contains the correct MTU (as defined in `tcp-mss`) to be used by the application server, which should receive this message and adjust the packet size accordingly. This is specifically required with VPNs, as IPsec has added packet overhead; thus `tcp-mss` must be lowered appropriately.

NOTE: When running SRX Series Firewalls in packet mode, you use the `set system internet-options tcp-mss` to adjust the TCP-MSS value. All ports are affected by the TCP-MSS configuration; you cannot exclude a particular port. When running SRX Series Firewalls in flow mode, although you can use the `set system internet-options tcp-mss`, we recommend using only the `set security flow tcp-mss` to adjust the TCP-MSS value. If both statements are configured, the lower of the two values will take effect.

Configuration

IN THIS SECTION

- Procedure | 66
- Results | 66

Procedure

Step-by-Step Procedure

To configure the maximum segment size for all TCP sessions:

1. Set the TCP maximum segment size for all TCP sessions.

```
[edit security flow]
user@host# set tcp-mss all-tcp mss 1300
```

2. If you are done configuring the device, commit the configuration.

```
[edit ]
user@host# commit
```

Results

From configuration mode, confirm your configuration by entering the `show security flow` command. If the output does not display the intended configuration, repeat the configuration instructions in this example to correct it.

For brevity, this `show` command output includes only the configuration that is relevant to this example. Any other configuration on the system has been replaced with ellipses (...).

```
[edit]
user@host# show security flow
...
tcp-mss{
  all-tcp{
```

```
    mss 1300;  
  }  
}  
...
```

Verification

To verify the configuration is working properly, enter the `show configuration security flow` command from operational mode.

```
user@host> show configuration security flow  
tcp-mss{  
  all-tcp{  
    mss 1300;  
  }  
}
```

TCP Out-of-State Packet Drop Logging Overview

IN THIS SECTION

- [Understanding TCP Out-of-State Packet Drop Logging | 68](#)
- [Supported TCP Out-of-State Logging Features | 69](#)

Within any packet-switched network, when demand exceeds available capacity, the packets are queued up to hold the excess packets until the queue fills, and then the packets are dropped. When TCP operates across such a network, it takes any corrective actions to maintain error-free end-to-end communications.

Flow modules already support generating RTLOG for session-based events like session creation and session close. SRX Series Firewalls now support the generation of RTLOG for packet-based events like packet drop without a session existing.

SRX Series Firewalls support logging of unsynchronized TCP out-of-state packets that are dropped by the flow module.

The TCP out-of-state packet drop logging feature avoids any packet loss and enables packet recovery by logging the out-of-sync packets for error free communication, and prevents the database servers from going out of sync. This feature is built on top of the security log (RTLOG) facility.

TCP out-of-state packet drop logging supports capturing of TCP packet drop logs under the following conditions:

- **Session ages out**—When there are cloud applications running on top of long TCP sessions, and when these applications do not refresh the TCP sessions after the session ages out, the TCP packets are dropped. This feature supports logging of these dropped TCP packets.
- **Unsynchronized first packets due to attacks or asymmetric routes**—When you deploy SRX Series Firewalls at two sites, and when routing sometimes forces asymmetric traffic, the synchronization (SYN) packet is seen at one site but the synchronization acknowledgment (SYN_ACK) packets are seen at another site.

This means that the SRX Series Firewall sees a TCP ACK packet for which it does not have a matching state table entry. This might occur because the connection was inactive for a period of time or the connections tables were flushed (for example, because of a policy installation or restart).

The SYN_ACK packets that are seen at another site in this case were denied by the SRX Series Firewall but were not logged. This feature supports logging of the denied SYN_ACK packets.

- **Other out-of-state conditions (like TCP sequence check fail and synchronization packet received in FIN state)**—When an SRX Series Firewall detects a sequence failure, if the device is in TCP four-way close state but receives SYN packets, or if there is a three-way handshake failure, the SRX Series Firewall drops the TCP packets and these dropped packets are logged.

NOTE: The unsynchronized TCP out-of-state packet drop log is a packet-based log, not a session-based log.

TCP out-of-state packet drop logging is designed with a throttle mechanism to protect CPU from being attacked, and within each throttle interval some logs can be dropped.

Only TCP out-of-state packets dropped by Flow module are logged. TCP packets dropped by TCP-proxy and IDP are not logged.

Understanding TCP Out-of-State Packet Drop Logging

To understand the implementation of TCP out-of-state packet drop logging, consider that you deploy SRX Series Firewalls at two sites and that routing sometimes forces asymmetrical traffic, where the SYN packet is seen at one site but the SYN_ACK packet is seen at another site. The SYN_ACK packet in this case would be denied but not logged. The TCP out-of-state packet drop logging feature provides visibility into these unsynchronized packet drops.

Consider the scenario where databases within the data center keep their TCP sockets open, with no keepalives being sent. If no data is being transmitted, the SRX Series Firewall will timeout the sessions. Although the databases will send some data through that TCP socket, when the traffic reaches the SRX Series Firewall, the session is no longer there and the packet is dropped, but not logged. These out-of-state TCP packets that are dropped are now logged by the SRX Series Firewall.

Supported TCP Out-of-State Logging Features

TCP out-of-state logging supports the following features:

- A packet filter component to filter target traffic.
- A throttle component to protect CPU from being overloaded by log messages.
- Flexibility to change the log generation rate.

Packet Filter Component

The logging filter leverages the current flow trace filter. It provides different ways to filter traffic. You must configure the filters to generate packet logs, otherwise logs will not be triggered.

This filter functionality avoids enabling logs unexpectedly. The maximum filters supported are 64.

Use the `set security flow packet-log packet-filter <filter-name>` command to enable the related filter components you want.

Throttle Component

Logging every TCP out-of-state packet can overload the device when traffic is heavy or when an attack occurs. If the CPU is idle and you want to log as many messages as possible, then this could lead to CPU overload.

The throttle mechanism allows you to configure the throttle interval from the CLI, so you can protect your CPU from being overloaded.

A hash table is introduced to map your logged data. The hash key is generated with the source-IP address, destination-IP address, source port, and destination port.

Within each throttle interval, only a limited number (more than one) of messages will be sent to RTLOG. The remaining log messages will be throttled.

The default throttle interval is 1 second. The throttle interval (at the millisecond level) needs to be configured as a power of two or zero (0, 1, 2, 4, 8, 16 ... 2^N).

When the throttle interval is configured as 0, no throttle mechanism will be involved. This is suitable for scenarios where traffic is very light and you want to record all the packet drop logs.

Configuration of the throttle interval as 2^N makes the throttle mechanism lockless and provides good log capture performance.

Flexibility for Changing the Log Generation Rate

Based on the throttle interval set, the log generation rate can be modified and managed.

This means that within each 32-millisecond (ms) interval, a limited number of logs could be generated and the remaining could be dropped. We recommend that you configure the interval as (0, 1, 2, 4, 8, 16, 32 ... 2^N).

If the input value is not aligned to 2^N , it will be aligned to 2^N automatically during flow processing. For example, if you configure a 10-ms interval it will be aligned to an 8-ms interval automatically.

Understanding How Preserving Incoming Fragmentation Characteristics Can Improve Throughput

This topic covers the benefits of using the SRX Series Firewall to preserve the characteristics of incoming packet fragments.

When data is sent from one host to another, it is transmitted as a series of packets. Performance is improved and network resources are conserved when packets of the largest size can transit the path from the source node to the destination node without being fragmented at any link in the datapath. When a packet must be fragmented into smaller packets to transit a link in the path because the packet is larger than that of the maximum transmission unit (MTU) established for that link, each of the resulting fragments must contain packet header information, in addition to the payload, or data. The increased overhead can lower throughput and degrade network performance. Also, the packet fragments must be reassembled at the destination node, which consumes additional network resources.

On the other hand, network resources are wasted when a host sends packets that are much smaller than the path MTU (path maximum transmission unit), resulting in suboptimal throughput. The path MTU discovery process works to discover the optimal MTU size for fragments that transit the datapath from the source node to the destination node for a session. The optimal packet size, then, is that of the path MTU. Fragmentation occurs when the size of a packet exceeds the path MTU.

If application-layer services are configured on the SRX Series Firewall, packet fragments at the ingress interface must be reassembled before the services can be applied and the content inspected. These reassembled packet fragments must be broken down again before the data is transmitted out the egress interface. Normally, it is the MTU size of the egress interface that determines the size of fragments transmitted out the SRX Series Firewall to the next link. It could be the case that the egress MTU size on the SRX Series Firewall is larger than the path MTU, which, again, would result in packet fragmentation

in the datapath, reducing performance or causing packet drop. Packet fragments must be small enough to transit every link in the path from source to destination.

By default, the SRX Series Firewall uses the MTU size configured for the egress interface to determine the size for packet fragments it transmits. However, if you enable the feature for preserving incoming fragment characteristics, the SRX Series Firewall detects and saves the size of incoming packet fragments.

To diminish the likelihood of packet fragmentation in the datapath, the SRX Series Firewall keep track of and adjust the egress MTU for that flow. It identifies the maximum size of all incoming fragments. It uses that information in conjunction with the existing MTU of the egress interface to determine the correct MTU size for fragmented packets sent out the egress interface. The SRX Series Firewall compares the two numbers. It takes the smaller number and uses it for the egress interface MTU size.

Configure the device using the `set security flow preserve-incoming-frag-size` command to enable the feature that takes into account the size of incoming packet fragments.

[Table 6 on page 71](#) summarizes how the SRX Series egress MTU size is determined.

Table 6: How the Final Egress MTU Size for Fragments Exiting the SRX Series Firewall Is Determined

Incoming Fragment Size	Existing Egress MTU Size	Final Egress MTU Size
If the largest fragment is	<i>smaller</i> than the existing egress MTU size	largest incoming fragment size is used.
If the largest fragment is	larger than the existing egress MTU size	existing egress interface MTU is used.

NOTE: This feature is supported on SRX Series Firewalls. It supports through-traffic and traffic exiting a tunnel. It applies to both IPv4 and IPv6 traffic.

The following two considerations affect fragment size:

- For stream-based applications, such as Content Security and ALG, the applications themselves could change or reassemble packets even if there were no fragments received. In this case, the existing egress interface MTU is used.
- When a path MTU discovery packet is delivered to a session, the path MTU for that session is reset to the value established by the path MTU packet.

Release History Table

Release	Description
15.1X49-D100	Configure the device using the set security flow preserve-incoming-frag-size command to enable the feature that takes into account the size of incoming packet fragments.

RELATED DOCUMENTATION

[Flow-Based Performance | 83](#)

[Flow Distribution and Packet-Ordering | 87](#)

ECMP Flow-Based Forwarding

IN THIS SECTION

- [Understanding ECMP Flow-Based Forwarding | 72](#)
- [Example: Configuring ECMP Flow-Based Forwarding | 76](#)

This topic provides a brief overview of equal-cost multipath (ECMP) for forwarding and reverse side traffic on Junos OS SRX Series Firewalls and vSRX Virtual Firewall instances. For comprehensive coverage of the ECMP implementation on Junos OS SRX Series Firewalls and vSRX Virtual Firewall instances.

Understanding ECMP Flow-Based Forwarding

IN THIS SECTION

- [ECMP Implementation for Junos OS SRX Series Firewalls and vSRX Virtual Firewall Instances | 74](#)
- [ECMP for Reverse Traffic | 75](#)

Equal-cost multipath (ECMP) is a network routing strategy that allows for traffic of the same session, or flow—that is, traffic with the same source and destination—to be transmitted across multiple paths of equal cost. It is a mechanism that allows you to load balance traffic and increase bandwidth by fully utilizing otherwise unused bandwidth on links to the same destination.

When forwarding a packet, the routing technology must decide which next-hop path to use. In making a determination, the device takes into account the packet header fields that identify a flow. When ECMP is used, next-hop paths of equal cost are identified based on routing metric calculations and hash algorithms. That is, routes of equal cost have the same preference and metric values, and the same cost to the network. The ECMP process identifies a set of routers, each of which is a legitimate equal cost next hop towards the destination. The routes that are identified are referred to as an ECMP set. Because it addresses only the next hop destination, ECMP can be used with most routing protocols.

An equal-cost multipath (ECMP) set is formed when the routing table contains multiple next-hop addresses for the same destination with equal cost. (Routes of equal cost have the same preference and metric values.) If there is an ECMP set for the active route, Junos OS uses a hash algorithm to choose *one* of the next-hop addresses in the ECMP set to install in the forwarding table.

You can configure Junos OS so that multiple next-hop entries in an ECMP set are installed in the forwarding table. On Juniper Networks devices, per-flow load balancing can be performed to spread traffic across multiple paths between routing devices. On Juniper Networks security devices, source and destination IP addresses and protocols are examined to determine individual traffic flows. Packets for the same flow are forwarded on the same interface; the interface does not change when there are additions or changes to the ECMP set. This is important for features such as source NAT, where the translation is performed only during the first path of session establishment for IDP, ALG, and route-based VPN tunnels. If a packet arrives on a given interface in an ECMP set, the security device ensures that reverse traffic is forwarded through the same interface.

NOTE: ECMP flow-based forwarding on security devices applies to IPv4 and IPv6 unicast traffic flows. Starting with Junos OS Release 15.1X49-D60, ECMP flow-based forwarding of IPv6 unicast traffic is supported on all SRX Series Firewalls and vSRX Virtual Firewall instances. Multicast flow is not supported.

On Juniper Networks security devices, the maximum number of next-hop addresses in an ECMP set that can be installed in the forwarding table is 16. If there are more than 16 next-hop addresses in an ECMP set, only the first 16 addresses are used.

In a *chassis cluster* deployment, a *local* interface is an interface that is on the same node as the interface on which a packet arrives, and a *remote* interface is an interface that is on the other chassis cluster node. If an ECMP route has both local and remote interfaces in a chassis cluster, then the local interface is favored for the next hop.

If a next-hop address is no longer part of the ECMP set or if it is removed from the routing table because of a route change, a flow that uses the next hop is rerouted and the session is not affected. Rerouting of the flow also occurs if there is a configuration change that takes away the next-hop address or if an administrator takes down the next-hop interface without deleting it. If a next-hop address is removed from the routing table because the interface is deleted or the session is intentionally cleared, the session is killed without being rerouted.

NOTE: We recommend that interfaces in an ECMP set be in the same security zone. If a flow is rerouted and the rerouted flow uses an interface in a different security zone than the original route, the session is killed.

To configure ECMP flow-based forwarding on Juniper Networks security devices, first define a load-balancing routing policy by including one or more `policy-statement` configuration statements at the `[edit policy-options]` hierarchy level, with the action `load-balance per-packet`. Then apply the routing policy to routes exported from the routing table to the forwarding table. To do this, include the `forwarding-table` and `export` configuration statements at the `[edit routing-options]` hierarchy level.

ECMP Implementation for Junos OS SRX Series Firewalls and vSRX Virtual Firewall Instances

You can configure ECMP for SRX Series Firewalls and vSRX Virtual Firewall instances to implement per-flow load balancing to spread traffic across multiple paths between routing devices. Routes of equal cost have the same preference and metric values. These devices examine the source IP address, the destination IP address, and the protocol to determine individual traffic flows. Traffic with the same source IP address, destination IP address, and protocol number that is permitted by a security policy is forwarded to the same next hop. Junos OS on these devices uses the flow information in its hashing logic.

For Junos OS SRX Series Firewalls and vSRX Virtual Firewall instances, an ECMP set is formed when the routing table contains multiple next-hop addresses for the same destination with equal cost. ECMP allows for multiple next-hop entries in an ECMP set to be installed in the forwarding table. Packets for the same flow are forwarded on the same interface; the interface does not change when there are additions or changes to the ECMP set.

If there is an ECMP set for the active route, Junos OS uses a hash algorithm to choose *one* of the next-hop addresses in the ECMP set to install in the forwarding table.

NOTE: ECMP flow-based forwarding on SRX Series Firewalls and vSRX Virtual Firewall instances applies to IPv4 and IPv6 unicast traffic flows. Starting in Junos OS Release 15.1X49-D60 and

Junos OS Release 17.3R1, ECMP flow-based forwarding of IPv6 unicast traffic is supported on all SRX Series Firewalls and vSRX Virtual Firewall instances. Multicast flow is not supported.

ECMP for Reverse Traffic

Starting in Junos OS Release 17.3, if you enable ECMP support for reverse traffic, the SRX Series Firewall uses a hash algorithm to determine the interface to use for reverse traffic in a flow. This process is similar to asymmetric routing in which a packet traverses from a source to a destination in one path and takes a different path when it returns to the source.

If you do not enable this feature, the SRX Series Firewall selects a route in the ECMP set to the incoming interface for reverse traffic, which is the default behavior.

You use the `allow-reverse-ecmp` configuration statement in the `[edit security flow]` hierarchy to configure ECMP flow-based forwarding to use a hash algorithm in selecting a route in the ECMP set for reverse traffic transit. That is, if you enable this function, rather than selecting a route to the incoming interface, the SRX Series Firewall uses a hash algorithm to select a route in the ECMP set for reverse traffic.

Because the ECMP flow-based policy is zone-based, ECMP reverse lookup support ensures that the egress interface used for reverse traffic is in the same zone as the ingress interface used for arriving traffic.

NOTE: Interfaces in an ECMP set must be in the same security zone. If the egress interface zone is different from the ingress interface zone, a session can be created but the packets will be dropped.



CAUTION: If you decide to enable reverse ECMP, be aware of the following condition and take action to avoid it: When ECMP flow-based forwarding is used, the SRX Series Firewall could cause upstream devices to see only one-way traffic of a session. Problems might ensue for upstream devices that maintain session state, for example, for TCP-proxy and SYN-proxy. The issue is similar to asynchronous routing behavior.

Example: Configuring ECMP Flow-Based Forwarding

IN THIS SECTION

- Requirements | 76
- Overview | 76
- Configuration | 77
- Verification | 82

This example shows how to configure ECMP flow-based forwarding.

Requirements

No special configuration beyond device initialization is required before configuring this feature.

Overview

IN THIS SECTION

- Topology | 76

This example configures three static ECMP routes on an SRX Series Firewall. Each static route uses a different next-hop router to reach the destination server. The interfaces towards the routers are assigned to the untrust security zone. This example creates a load-balancing routing policy named `load-balancing-policy` and applies the policy to all routes exported from the routing table to the forwarding table.

Topology

[Figure 10 on page 77](#) shows the topology used in this example.

Figure 10: ECMP Routes

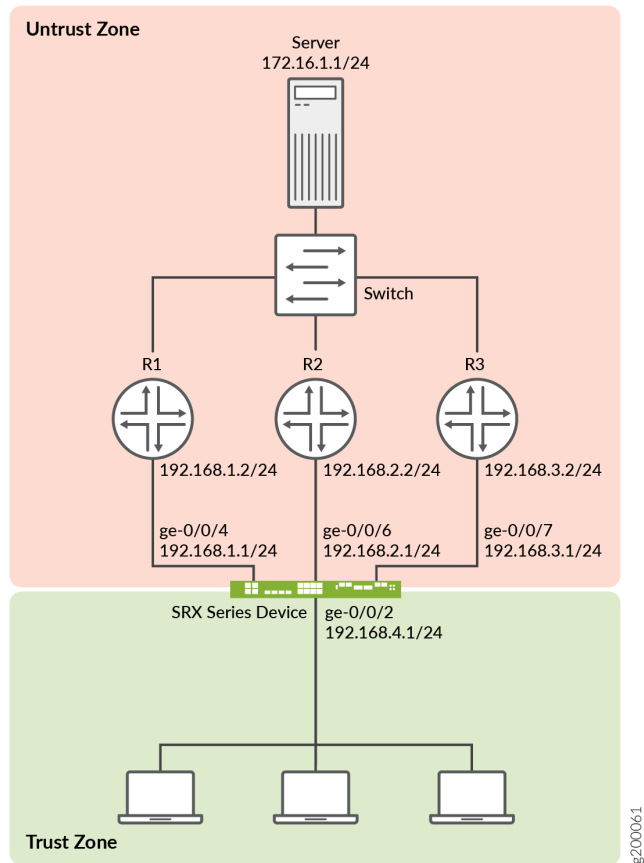

Configuration

IN THIS SECTION

- [CLI Quick Configuration | 78](#)
- [Procedure | 78](#)

CLI Quick Configuration

To quickly configure this example, copy the following commands, paste them into a text file, remove any line breaks, change any details necessary to match your network configuration, and then copy and paste the commands into the CLI at the [edit] hierarchy level.

```
## Interfaces ##
set interfaces ge-0/0/2 unit 0 family inet address 192.168.4.1/24
set interfaces ge-0/0/4 unit 0 family inet address 192.168.1.1/24
set interfaces ge-0/0/6 unit 0 family inet address 192.168.2.1/24
set interfaces ge-0/0/7 unit 0 family inet address 192.168.3.1/24
## Static routes ##
set routing-options static route 172.16.1.0/24 next-hop 192.168.1.2
set routing-options static route 172.16.1.0/24 next-hop 192.168.2.2
set routing-options static route 172.16.1.0/24 next-hop 192.168.3.2
## Security zones, address book entry, and policy ##
set security zones security-zone trust interfaces ge-0/0/2
set security zones security-zone untrust interfaces ge-0/0/4
set security zones security-zone untrust interfaces ge-0/0/6
set security zones security-zone untrust interfaces ge-0/0/7
set security address-book global address FTP-servers 172.16.1.0/24
set security policies from-zone trust to-zone untrust policy permit-ftp match source-address any
set security policies from-zone trust to-zone untrust policy permit-ftp match destination-
address FTP-servers
set security policies from-zone trust to-zone untrust policy permit-ftp match application junos-
ftp
set security policies from-zone trust to-zone untrust policy permit-ftp then permit
## ECMP routing policy ##
set policy-options policy-statement load-balancing-policy then load-balance per-packet
set routing-options forwarding-table export load-balancing-policy
```

Procedure

Step-by-Step Procedure

The following example requires you to navigate various levels in the configuration hierarchy.

To configure ECMP flow-based forwarding:

1. Configure interfaces.

```
[edit interaces]
user@host# set ge-0/0/2 unit 0 family inet address 192.168.4.1/24
user@host# set ge-0/0/4 unit 0 family inet address 192.168.1.1/24
user@host# set ge-0/0/6 unit 0 family inet address 192.168.2.1/24
user@host# set ge-0/0/7 unit 0 family inet address 192.168.3.1/24
```

2. Configure static routes.

```
[edit routing-options]
user@host# set static route 172.16.1.0/24 next-hop 192.168.1.2
user@host# set static route 172.16.1.0/24 next-hop 192.168.2.2
user@host# set static route 172.16.1.0/24 next-hop 192.168.3.2
```

3. Create the trust and untrust security zones, and include the related interfaces.

```
[edit security]
user@host# set zones security-zone trust interfaces ge-0/0/2
user@host# set zones security-zone untrust interfaces ge-0/0/4
user@host# set zones security-zone untrust interfaces ge-0/0/6
user@host# set zones security-zone untrust interfaces ge-0/0/7
```

4. Configure an address book entry for the server subnet.

This entry is used in the security policy.

```
[edit security address-book]
user@host# set global address FTP-servers 172.16.1.0/24
```

5. Configure a security policy.

```
[edit security policies from-zone trust to-zone untrust]
user@host# set policy permit-ftp match source-address any
user@host# set policy permit-ftp match destination-address FTP-servers
user@host# set policy permit-ftp match application junos-ftp
user@host# set policy permit-ftp then permit
```

6. Create a load-balancing routing policy.

```
[edit policy-options]
user@host# set policy-statement load-balancing-policy then load-balance per-packet
```

7. Apply the routing policy to all routes exported from the routing table to the forwarding table.

```
[edit routing-options]
user@host# set forwarding-table export load-balancing-policy
```

Results

From configuration mode, confirm your configuration by issuing the `show interfaces`, `show security`, `show policy-options`, and `show routing-options` commands. If the output does not display the intended configuration, repeat the instructions in this example to correct the configuration.

```
[edit]
user@host# show interfaces
ge-0/0/2 {
  unit 0 {
    family inet {
      address 192.168.4.1/24;
    }
  }
}
ge-0/0/4 {
  unit 0 {
    family inet {
      address 192.168.1.1/24;
    }
  }
}
ge-0/0/6 {
  unit 0 {
    family inet {
      address 192.168.2.1/24;
    }
  }
}
```



```
ge-0/0/7 {
  unit 0 {
    family inet {
      address 192.168.3.1/24;
    }
  }
}
user@host# show security
address-book {
  global {
    address FTP-servers 172.16.1.0/24;
  }
}
policies {
  from-zone trust to-zone untrust {
    policy permit-ftp {
      match {
        source-address any;
        destination-address FTP-servers;
        application junos-ftp;
      }
      then {
        permit;
      }
    }
  }
}
zones {
  security-zone trust {
    interfaces {
      ge-0/0/2.0;
    }
  }
  security-zone untrust {
    interfaces {
      ge-0/0/4.0;
      ge-0/0/6.0;
      ge-0/0/7.0;
    }
  }
}
user@host# show policy-options
policy-statement load-balancing-policy {
```

```

    then {
        load-balance per-packet;
    }
}

```

```

[edit]
user@host# show routing-options
static {
    route 172.16.1.0/24 next-hop [ 192.168.1.2 192.168.2.2 192.168.3.2 ];
}
forwarding-table {
    export load-balancing-policy;
}

```

If you are done configuring the device, enter `commit` from configuration mode.

Verification

IN THIS SECTION

- [Verifying the Forwarding Table | 82](#)

Verifying the Forwarding Table

Purpose

Verify that the route information for all ECMP routes appears in the forwarding table.

Action

From operational mode, enter the `show route forwarding-table destination 172.16.1.0` command.

```

user@host> show route forwarding-table destination 172.16.1.0
Routing table: default.inet
Internet:
Destination      Type RtRef Next hop          Type Index NhRef Netif
172.16.1.0/24    user  0          ulst 262142  2

```

	192.168.1.2	ucst	560	2	ge-0/0/4.0
	192.168.2.2	ucst	561	2	ge-0/0/6.0
	192.168.3.2	ucst	562	2	ge-0/0/7.0
	...				

Meaning

The output shows a next hop type of `ulst`, which means the route has multiple eligible next hops. Packets destined for the 172.16.1.0 network can use any next hop in the list.

Release History Table

Release	Description
15.1X49-D60	Starting with Junos OS Release 15.1X49-D60, ECMP flow-based forwarding of IPv6 unicast traffic is supported on all SRX Series Firewalls and vSRX Virtual Firewall instances. Multicast flow is not supported.
15.1X49-D60	Starting in Junos OS Release 15.1X49-D60 and Junos OS Release 17.3R1, ECMP flow-based forwarding of IPv6 unicast traffic is supported on all SRX Series Firewalls and vSRX Virtual Firewall instances. Multicast flow is not supported.

RELATED DOCUMENTATION

[Flow-Based Sessions](#) | 52

[Flow Distribution and Packet-Ordering](#) | 87

Flow-Based Performance

IN THIS SECTION

- [Expanding Session Capacity by Device](#) | 84
- [Verifying the Current Session Capacity](#) | 86

This topics explains about the performance of the session capacity. Expanding the session capacity and reverting back to the default session capacity.

Expanding Session Capacity by Device

IN THIS SECTION

- [Expanding Session Capacity on an SRX3400 or SRX3600 Device | 85](#)
- [Reverting to Default Session Capacity on an SRX5800 Device | 85](#)

To take advantage of the processing potential of a fully loaded SRX5600, SRX5800 device, or vSRX Virtual Firewall, you can expand the maximum number of concurrent sessions for these devices.

[Table 7 on page 84](#) shows the maximum number of concurrent sessions allowed on these devices by default and with expanded capacity. Platform support depends on the Junos OS release in your installation.

Table 7: Maximum Central Point Session Increases

SRX Series Devices	Maximum Concurrent Sessions on a Fully Loaded System	
	Default	With Expanded Capacity
SRX3400	2.25 million	3 million
SRX3600	2.25 million	6 million
SRX5400	42 million	Expansion not available
SRX5600	114 million	Expansion not available
SRX5800	258 million	Expansion not available

Table 7: Maximum Central Point Session Increases (Continued)

SRX Series Devices	Maximum Concurrent Sessions on a Fully Loaded System	
	Default	With Expanded Capacity
SPC2	6 million	Expansion not available
SPC3	25 million	Expansion not available

The method used for expanding session capacity depends on the device:

- Central point session license installation and validation on an SRX3400 or SRX3600 device
- CLI optimization option on an SRX5800 device

Expanding Session Capacity on an SRX3400 or SRX3600 Device

Expanding session capacity on an SRX3400 or SRX3600 device requires validation of a central point session license on the device.

1. Obtain the central point session license key and install the license on the device..
2. Reboot the device to implement the expanded session capacity.

Reverting to Default Session Capacity on an SRX5800 Device

Reverting to the default session capacity on an SRX5800 device requires a CLI configuration change.

1. Enter the following command at the CLI configuration prompt to reestablish the default session capacity value:

```
user@host# set security gprs gtp enable
```

2. Commit the configuration.

```
user@host# commit
```

3. Reboot the device to implement the new value.

Verifying the Current Session Capacity

IN THIS SECTION

- Purpose | 86
- Action | 86
- Meaning | 87

Purpose

The central point session summary includes the maximum sessions setting for the device. From this value you can determine if the session capacity has been modified as you expected.

Action

To verify the current setting of the central point session capacity, enter the following CLI command.

```
user@host> show security flow cp-session summary
```

```
DCP Flow Sessions on FPC10 PIC0:
```

```
Valid sessions: 0
```

```
Pending sessions: 0
```

```
Invalidated sessions: 0
```

```
Sessions in other states: 0
```

```
Total sessions: 0
```

```
DCP Flow Sessions on FPC10 PIC1:
```

```
Valid sessions: 2
```

```
Pending sessions: 0
```

```
Invalidated sessions: 0
```

```
Sessions in other states: 0
```

```
Total sessions: 2
```

```
Maximum sessions: 7549747
```

```
Maximum inet6 sessions: 7549747
```

DCP Flow Sessions on FPC10 PIC2:

Valid sessions: 2

Pending sessions: 0

Invalidated sessions: 0

Sessions in other states: 0

Total sessions: 2

Maximum sessions: 7549747

Maximum inet6 sessions: 7549747

DCP Flow Sessions on FPC10 PIC3:

Valid sessions: 1

Pending sessions: 0

Invalidated sessions: 0

Sessions in other states: 0

Total sessions: 1

Maximum sessions: 7549747

Maximum inet6 sessions: 7549747

Meaning

The `Maximum sessions` value reflects the current session capacity on your device. A value of 14000000 means that the SRX5800 device is configured for the expanded number of central point sessions.

Flow Distribution and Packet-Ordering

IN THIS SECTION

- [Understanding Load Distribution in SRX5000 Line Devices | 88](#)
- [Understanding Packet-Ordering Function on SRX5000 Line Devices | 91](#)
- [Understanding Session Distribution on SRX5000 Line Devices in Adaptive Mode | 94](#)

This topic describes about the load distribution and the packet ordering on SRX5000 Line devices.

Understanding Load Distribution in SRX5000 Line Devices

IN THIS SECTION

- [Calculating SPU ID | 89](#)
- [Hash-Based Forwarding on the SRX5K-MPC, SRX5K-MPC3-40G10G \(IOC3\), and the SRX5K-MPC3-100G10G \(IOC3\) | 89](#)

The load distribution algorithm, which is supported on the SRX5800, SRX5600, and SRX5400 devices, is adjusted based on session capacity and processing power. (Actual platform support depends on the Junos OS release in your installation.)

Hash-based session distribution uses a hash table. The SPU session weight table is used to assign an SPU ID to each hash index in the session distribution hash table. This way, the number of sessions created on each SPU using hash-based distribution is proportional to the SPU's weight in the SPU session weight table. Each NPU also keeps an identical SPU session weight table and session distribution hash table that it uses to select an SPU to forward packets that do not match an NPU session.

In the event of a SPU failure, the Routing Engine will reset all of the cards on the dataplane including IOCs and NPCs in order to maintain hash table consistency for session distribution.

In hash-based session distribution, weights are based on session capacity. We recommend the hash session distribution mode when high session capacity is required.

NOTE: Load distribution on SRX5000 line devices is always hash-based.

Insertion and removal of SPCs causes recalculation of the SPU session weight table at central point initialization time because the chassis must reboot after insertion.

Starting in Junos OS Release 15.1X49-D30, the central point architecture is enhanced to handle higher concurrent sessions and connections per second (cps) for the SRX5000 line device.

The central point architecture enhancements prevent data packets from going through the central point by offloading traffic management to SPUs. The system session capacity is extended, as the session limit on the central point is removed.

Calculating SPU ID

The SPU ID for a device equipped with SRX3K-SPC-1-10-40, SRX5K-SPC-2-10-40, or SRX5K-SPC3 Services Processing Card (SPC) is calculated as follows:

$$\text{SPU ID} = (\text{FPC ID} \times 4) + \text{PIC ID}$$

The SRX3K-SPC-1-10-40, SRX5K-SPC-2-10-40, and SRX5K-SPC3 contains two PICs per card, four PICs per card (FPC), and two PICs per card respectively. For example, a device contains 2 cards in slot 1 (FPC ID 0) and slot 2 (FPC ID 1), the expected SPU IDs are as follows:

- For SPC1: (0, 1) and (4, 5), total 4 SPUs in 2 cards.
- For SPC2: (0, 1, 2, 3) and (4, 5, 6, 7), total 8 SPUs in 2 cards.
- For SPC3: (0, 1) and (4, 5), total 4 SPUs in 2 cards.

For FPC1 (the second card) and PIC1 (the second PIC in the card), the SPU ID is calculated as:

$$\begin{aligned} \text{SPU ID} &= (\text{FPC ID} \times 4) + \text{PIC ID} \\ &= (1 \times 4) + 1 \\ &= 4 + 1 \\ &= 5 \end{aligned}$$

Use this convention while referring the SPU ID for CLI and SNMP.

Hash-Based Forwarding on the SRX5K-MPC, SRX5K-MPC3-40G10G (IOC3), and the SRX5K-MPC3-100G10G (IOC3)

On these SRX Series Firewalls, a packet goes through a series of events involving different components as it progresses from ingress to egress processing. With the datapath packet forwarding feature, you can obtain quick delivery of I/O traffic over the SRX 5000 line of devices.

The SRX5K-MPC, SRX5K-MPC3-40G10G (IOC3), and SRX5K-MPC3-100G10G (IOC3) are interface cards supported on the SRX5400, SRX5600, and SRX5800 devices. The Modular Port Concentrator (MPC) provides load-balancing services for Services Processing Units (SPUs) by using the hash-based forwarding method.

In hash-based forwarding, the packet might be forwarded by the MPC to a selected SPU (DCP) instead of the central point. This approach enhances session scaling and prevents overloading of the central point.

Hash value calculation involves the following steps:

- For IPv4 packets, the hash-based forwarding module generates the hash value based on Layer 3 and Layer 4 information, depending on different Layer 4 protocol types.
- For Stream Control Transmission Protocol (SCTP), TCP, UDP, Authentication Header (AH), edge service provider (ESP), and Internet Control Message Protocol (ICMP) protocols, the hash module utilizes Layer 4 information to generate the hash value. For any other protocols, only Layer 3 information is used in hash generation.
- For IPv4 fragment packets, the hash value is calculated using only the Layer 3 information. This also applies to the first fragment of the packet.
- For non-IP packets, the hash-based forwarding module uses the Layer 2 information to calculate the hash value.

Once a hash value is calculated according to the packet's Layer 2, Layer 3, or Layer 4 information, an SPU ID is assigned to each hash index in the session distribution hash table.

NOTE: The SRX5K-MPC (IOC2), SRX5K-MPC3-40G10G (IOC3), and SRX5K-MPC3-100G10G (IOC3) can only be used on SRX5400, SRX5600, and SRX5800 devices that are configured for hash-based session distribution.

When the hash-based session distribution mode is enabled, the system changes its behavior to high-session-capacity-based mode when the SRX5K-MPC, SRX5K-MPC3-40G10G (IOC3), and SRX5K-MPC3-100G10G (IOC3) are installed on the device.

NOTE: On SRX5000 line devices with an SRX5K-MPC, SRX5K-MPC3-40G10G (IOC3), or SRX5K-MPC3-100G10G (IOC3) installed, during a system or an SPU reboot, when the hash-based session distribution mode is enabled, traffic will pass only when all SPUs are up after the reboot.

The MPCs on the IOC3 provide load-balancing services for SPUs by performing hash-based datapath packet forwarding to interconnect with all existing IOCs and SPCs.

The IOC3 processes ingress and egress packets. The IOC3 parses the ingress packet and sends it to the SPU for further security processing, including flow session lookup, zone and policy check, VPN, ALG, and so on.

The IOC3 manages packet data memory and fabric queuing for packet lookup and encapsulation functions.

NOTE: Starting with Junos OS Release 15.1X49-D10 and Junos OS Release 17.3R1, hash-based session distribution is the default mode for the SRX5400, SRX5600, and SRX5800 devices. Selection of hash keys depends on application protocols.

Starting with Junos OS Release 17.4R1, traffic is hashed and distributed to different SPUs by the IOC, based on a hash-based session distribution algorithm. This enhancement provides an even hash distribution among all SPUs by using a larger fixed-length hash table. In earlier Junos OS releases, the traffic distribution was uneven among all SPUs due to a fixed-length hash table.

The IOC3 sets up a security flow table (IPv4 and IPv6) including key, result table, and packet memory.

The following functions are provided with the flow table:

- Flow lookup
- Flow insertion and deletion
- Security flow aging out
- Security flow statistics

Understanding Packet-Ordering Function on SRX5000 Line Devices

IN THIS SECTION

- [Changing Packet-Ordering Mode on SRX5000 Line Devices | 92](#)

The packet-ordering function, which is supported on the SRX5400, SRX5600, and SRX5800, devices and vSRX Virtual Firewall, improves the performance of the device by activating the built-in packet-ordering function of the Packet Ordering Engine on the XLP processor on the application central point.

Two types of the packet ordering modes are supported: hardware and software.

If the packet-ordering function is set to *hardware*, the load-balancing thread (LBT) and the packet-ordering thread (POT) are offloaded to the packet ordering engine and resources are freed to perform packet processing. If the packet-ordering function is set to *software*, the load-balancing thread (LBT) and the packet-ordering thread (POT) are running on the SPU. By default, packet-ordering mode using the

Packet Ordering Engine (hardware) is enabled on the device. You can disable it with a configuration change that requires a reboot.

The flow thread receives the packets, processes them, and sends or drops them. For packets that require no ordering, the flow thread notifies the Network Acceleration Engine (NAE) egress to send or drop the packets. For packets that require ordering, the flow thread notifies the Packet Ordering Engine to dequeue the packets from the ordering list and to send or drop the packets in order.

Changing Packet-Ordering Mode on SRX5000 Line Devices

The packet-ordering functionality using the Packet Ordering Engine is supported on SRX5400, SRX5800 and SRX5600 devices with next-generation SPCs. (Platform support depends on the Junos OS release in your installation.) By default, packet-ordering mode using the Packet Ordering Engine is enabled. To disable the packet-ordering functionality using the Packet Ordering Engine, you must update the packet-ordering mode on the device.

The following packet ordering modes are supported:

- **software**—Disables the packet-ordering mode using the Packet Ordering Engine.
- **hardware**—Enables the packet-ordering mode using the Packet Ordering Engine. This is the default option.

To disable the packet-ordering mode using the Packet Ordering Engine:

1. Enter the following command at the CLI configuration prompt to specify the packet-ordering mode.

```
[edit]
user@host# set security forwarding-process application-services packet-ordering-mode software
```

2. Use the `show security forwarding-process` command to review your configuration.

```
[edit]
user@host# show security forwarding-process
application-services{
    packet-ordering-mode software;
}
```

3. Check your changes to the configuration before committing.

```
[edit]  
user@host# commit check
```

```
warning: System packet ordering mode changed, reboot is required to take effect.  
If you have deployed a cluster, be sure to reboot all nodes.  
configuration check succeeds
```

4. Commit the configuration.

```
[edit]  
user@host# commit
```

```
warning: System packet ordering mode changed, reboot is required to take effect.  
If you have deployed a cluster, be sure to reboot all nodes.  
commit complete
```

5. Reboot the device at an appropriate time.

6. Use the `show security flow status` command to verify the packet-ordering mode.

```
user@host> show security flow status  
  
Flow forwarding mode:  
  Inet forwarding mode: flow based  
  Inet6 forwarding mode: drop  
  MPLS forwarding mode: drop  
  ISO forwarding mode: drop  
Flow trace status  
  Flow tracing status: off  
Flow session distribution  
  Distribution mode: RR-based  
Flow packet ordering  
  Ordering mode: Software (reboot needed to change to Software)
```

Understanding Session Distribution on SRX5000 Line Devices in Adaptive Mode

Starting in Junos OS Release 15.1X49-D30 and Junos OS Release 17.3R1, adaptive mode session distribution was replaced by enhancements to the central point architecture.

Adaptive mode session distribution is implemented on the SRX5000 line devices running in mixed mode prior to Junos OS Release 15.1X49-D30 and Junos OS Release 17.1R1. Adaptive mode session distribution maximizes use of system resources by taking into account a Services Processing Unit's (SPU) capacity and its available resources. It is enabled only on SRX5000 line devices running in XLR/XLP mixed mode, that is in chassis deployments in which different types of SPUs are used in different combinations. If an SRX5800, SRX5600, or SRX5400 device contains a mix of next-generation services processing cards (SPCs) and existing SPCs, then adaptive mode session distribution is assumed as the default. For SRX5000 line devices not running in mixed mode, hash-based load balancing is the default.

A Services Processing Card (SPC) contains one or more SPUs each of which processes the packets of a flow according to the security features and other services configured for sessions distributed to it by the central point (CP). An SPU's CPU load changes from time to time. To fully utilize changing available capacity and adapt session distribution accordingly, in adaptive mode the system assigns a weight to all SPUs dynamically. It is the weight of the SPUs that determine the session distribution.

Each SPU sends its CPU usage information to the central point (CP) periodically. The central point checks these values, calculates the weight every 1 second, and distributes the sessions in such a way as to maximize overall system performance. In other words, In adaptive mode, session distribution is based on a *dynamic* weighted assignment system that is calculated in real time allowing for full capacity utilization of the CPUs of all SPUs, regardless of their type.

It is the dynamic calculation of weights that distinguishes adaptive mode session distribution from weighted round-robin (WRR) session distribution. While WRR differentiates SPUs and their CPU capacity by calculating and assigning weights to the different types of SPUs, the calculation and assignment is static, that is, it is done only once, at initialization. Adaptive mode improves on the fixed ratio session distribution process of WRR. WRR leads to underutilization of system resources because session processing limits are set based only on the type of SPU and its CPU capacity, not taking into account its available processing power.

For adaptive mode session distribution, the following formula is used to calculate the weight assigned to an SPU:

$$W_i = \text{Sum}(W_{1-n}) * C_i * S_i / \text{Sum}(C_{1-n} * S_{1-n})$$

Where:

- W_i — weight assigned to the SPU.
- $\text{Sum}(W_{1-n})$ — Total weight of system. This values is constant.

- n —total number of SPUs.
- C_i —available CPU computational power of the SPU.
- S_i —available session capacity of SPU.

In adaptive mode, when the CPU usage on one SPU is high, fewer sessions are distributed to that SPU. The following examples explain the calculation.

Consider a device with two SPUs. Each SPU's session capacity is 1 million.

For a certain time:

- When SPU1 has 500,000 sessions on it, CPU usage of it is 10 percent:
 - Available CPU capacity of SPU1 (C_1) = $1 - 10$ percent = 90 (percent).
 - Available session capacity of SPU1 (S_1) = $1 - 500,000/1M = 50$ (percent).
- When SPU2 has 400,000 sessions on it, CPU usage of it is 20 percent:
 - Available capacity of SPU2 (C_2) = $1 - 20$ percent = 80 (percent).
 - Available session capacity of SPU2 (S_2) = $1 - 400,000/1M = 60$ (percent).

If the weight of the whole system is 100, the separate weight values for each SPU are:

- Weight of SPU1 (W_1) = $100 * 90 * 50 / (50 * 90 + 80 * 60) = 48$
- Weight of SPU2 (W_2) = $100 * 80 * 60 / (50 * 90 + 80 * 60) = 52$

For the incoming sessions, 48 percent of sessions are allocated to SPU1 while 52 percent of packets are allocated to SPU2.

The weighted numbers might take effect on the system within a short period before the central point checks the runtime usage information and adjusts the weights to a new value.

Release History Table

Release	Description
17.4R1	Starting with Junos OS Release 17.4R1, traffic is hashed and distributed to different SPUs by the IOC, based on a hash-based session distribution algorithm. This enhancement provides an even hash distribution among all SPUs by using a larger fixed-length hash table. In earlier Junos OS releases, the traffic distribution was uneven among all SPUs due to a fixed-length hash table.
15.1X49-D30	Starting in Junos OS Release 15.1X49-D30, the central point architecture is enhanced to handle higher concurrent sessions and connections per second (cps) for the SRX5000 line device.

15.1X49-D30	Starting in Junos OS Release 15.1X49-D30 and Junos OS Release 17.3R1, adaptive mode session distribution was replaced by enhancements to the central point architecture.
15.1X49-D10	Starting with Junos OS Release 15.1X49-D10 and Junos OS Release 17.3R1, hash-based session distribution is the default mode for the SRX5400, SRX5600, and SRX5800 devices. Selection of hash keys depends on application protocols.

RELATED DOCUMENTATION

[Flow-Based Sessions | 52](#)

[TCP Sessions | 59](#)

[ECMP Flow-Based Forwarding | 72](#)

PowerMode

IN THIS SECTION

- [PowerMode | 96](#)
- [PowerMode IPsec | 97](#)
- [Understanding PMI First Path and Fast Path Processing | 97](#)
- [Switching between PMI First Path and Fast Path Processing | 98](#)
- [Fragmentation for Incoming IP Packets | 98](#)
- [Fragmentation for Outgoing IP Packets | 99](#)
- [NP session support | 99](#)

PowerMode

PowerMode is a new default dataplane framework that introduces an optimized fast-path allowing for higher throughput and lower latency on SRX Series Firewalls. PowerMode is able to accelerate IPsec operations and generic TCP and UDP flows in the same manner as Express Path on Trio-Based platforms.

In Junos OS Release 21.3R1, the feature has the following limitations:

- Non-IP protocol.
- IP protocols which are not TCP, UDP, ESP, SCTP and GTP.
- Multicast sessions.
- Egress Logical Tunnel (LT) interfaces and cross-lsys traffic.
- Sessions that require TCP-Proxy.
- Firewall Filters.
- Mac learning and transparent mode.
- Active/Active HA clusters when the sessions are transiting the fabric link known as Z-mode traffic.

NOTE: SRX Series Firewalls with PMI supports only flow-based CoS (Class of Service).

SEE ALSO

| [power-mode-disable](#) | 362

PowerMode IPsec

PowerMode IPsec (PMI) is a new mode of operation for SRX4100, SRX4200, SRX4600, SRX5400, SRX5600, SRX5800, and vSRX Virtual Firewall instances to improve IPsec performance. Starting with Junos OS Release 19.1R1, the PMI is enhanced to handle the incoming and outgoing fragment packets using first path or fast path processing.

Enable the PMI process by using the `set security flow power-mode-ipsec` command. To verify that the packets are leveraging PMI, use the `show security flow pmi statistics` command.

Understanding PMI First Path and Fast Path Processing

In a PMI first path processing:

- The incoming first path packet is delivered to flow to create session.

- The incoming fragment packets are delivered to flow for reassembling.
- The incoming packets are delivered to flow for advanced security service processing.

In a PMI fast path processing, the PMI driver is used:

- To encrypt and send out the incoming clear text directly.
- To decrypt and send out the incoming ESP packets directly with session match.

Switching between PMI First Path and Fast Path Processing

The first path processing involves more features and instructions, while the PMI fast path processing provides better performance. In a PMI session, the packet processing switches between first path and fast path based on the packets flow in the session.

- The PMI session with both fragment and non-fragment packets are processed by first path.
- When the session only has non-fragmented packets, the session will switch from first path to fast path processing.

NOTE: On SRX5400, SRX5600, and SRX5800 devices, switching happens after the NP session timeout.

Fragmentation for Incoming IP Packets

To support fragmentation for incoming IP packets for PMI, following steps are used in first path:

- PMI transmits all the fragmented IP packets in a session to the flow module for processing.
- PMI transmits all the non-fragmented IP packets in the same session to the flow module for packet ordering.
- The Flow module completes reassembly of fragmented packets and transmits the packets back to PMI for encryption.

Fragmentation for Outgoing IP Packets

To support fragmentation for outgoing IP packets for PMI, following steps are used:

- PMI detects clear text packets that requires fragmentation during session lookup and delivers packets to the flow module.
- Flow module does fragmentation for outgoing packets.
- PMI encrypts the packets before transmitting them.

NP session support

On SRX4100, SRX4200, and vSRX Virtual Firewall devices, fragment and non-fragment packets are hashed to the same CPU core for processing. Hence, NP session is not supported.

On SRX5400, SRX5600, and SRX5800 devices with SPC3, fragment and non-fragment packets are hashed to different CPU cores for processing. Hence, NP session is supported to deliver fragment or non-fragment packets to the same core for ordering.

NOTE: If a PMI session or non-PMI session has no NP session installed due to limited NP session capacity then the packet ordering for this PMI session may not be available.

Release History Table

Release	Description
19.1R1	Starting with Junos OS Release 19.1R1, the PMI is enhanced to handle the incoming and outgoing fragment packets using first path or fast path processing.

Unified Policies Support for Flow

IN THIS SECTION

- [Flow First Path for Unified Policies | 100](#)

- [Understanding Flow Fast Path | 101](#)
- [Configuring the Session Log for the Default Security Policy | 102](#)
- [Configuring the Session Timeout for the Default Security Policy | 103](#)

Starting in Junos OS Release 18.2R1, unified policies are supported on SRX Series Firewalls, allowing granular control and enforcement of dynamic Layer 7 applications within the security policy. Unified policies are the security policies that enable you to use dynamic applications as match conditions as part of the existing 5-tuple or 6-tuple (5-tuple with user firewall) match conditions to detect application changes over time.

Unified policies allow you to use dynamic application as a policy match criteria in the application. On applying Application Identification (AppID) to the traffic, the AppID checks several packets and identifies the application. After the application is identified, the final policy is applied to the session. The policy actions such as permit, deny, reject, or redirect are applied to the traffic as per the policy.

During the initial policy lookup phase, which occurs prior to a dynamic application being identified, if there are multiple policies in the potential policy list, the SRX Series Firewall applies the default security policy until a more explicit match has occurred. The policy that best matches the application is the final policy.

For more information on unified policies, See [[Unified Security Policies, Application Identification Support for Unified Policies](#), and [Understanding IDP Policy Support for Unified Policies](#).]

Flow First Path for Unified Policies

When the device examines the first packet of a flow, it determines the corresponding security policy, and performs a security policy lookup. During this process following cases are observed:

- If the traffic matches a legacy security policy or the final policy, the session is created.
- If there are multiple policies in the potential policy list and there is a security policy conflict, then the default security policy is applied.
- If there are multiple policies in the potential policy list, and the policy action does not permit the traffic, then the session is closed. A log message is generated to indicate the reason for the session closure. The default security policy is required during policy conflict stage, because each policy in the potential policy list has different configuration values for MSS, TCP SYN check, session timeout interval, and so on. In this case, when the default security policy is applied, all the values configured

in that policy are applied. When a default security policy is matched, the policy actions are applied for the session.

NOTE:

- The default security policy is system-defined policy. This policy cannot be deleted.
- The default policy is created on every logical system level, similar to the global default policy.
- The session timeout interval and session log values are leveraged from the default security policy and default values such as TCP-MSS and TCP SYN are leveraged from the flow configuration.

- When a default policy is applied, a potential metadata for the policy action is allocated. The potential metadata is updated according to the potential policy list.

NOTE:

- Having a default security policy helps in resolving in the potential policy list.
- There can be many sessions matching the default security policy; however, the application services defined in the policy for the permitted traffic can be different. The security flow information for each session is saved.
- When an SRX Series Firewall is operating in chassis cluster mode, the information is synchronized from the primary node to the secondary node along with the flow session and the chassis cluster real time objects (RTO).

- When the final application is identified, the security policy matching with the final application is applied. The subsequent packets are processed according to the final policy.

Understanding Flow Fast Path

After the first packet in a flow has traversed the device and a session has been established for it, it undergoes fast path processing. When the device examines a security flow session with default policy, it performs a security policy lookup and following cases are observed:

- If the existing Application Identification requires an update, the policy lookup process is repeated. The process is repeated until an explicit policy is returned and replaced in the security flow session. If an implicit policy is returned, the traffic is denied and the session is closed.

- When the final application is identified, the final policy matching the traffic is applied. If the policy actions in the default and the final policy are similar, the final policy replaces the default policy in the security flow session. If the policy actions in the default and the final policy are different, default policy is retained and the security flow session is closed.

NOTE: When the final and the default policy with a deny action is matched, the security flow session is closed.

- To update a session, the session timeout, log, or counter configuration in the final policy is used.

Configuring the Session Log for the Default Security Policy

The default security policy is required to manage policy conflicts in the potential policy list. You can set the session logs for the required sessions in default security policy configurations:

You can enable logging at the end of a session and at the beginning of the session with the following commands:

1. Generate a Session_Create log for policies entering the global pre-id-default-policy.

[edit]

```
user@host# set security policies pre-id-default-policy then log session-init
```



CAUTION: Configuring session-init logging for the pre-id-default-policy can generate a large amount of logs. Each session that enters the SRX that initially matches the pre-id-default-policy will generate an event. We recommend only using this option for troubleshooting purposes.

2. Generate a Session_Close log for policies which close without exiting the global pre-id-default-policy.

[edit]

```
user@host# set security policies pre-id-default-policy then log session-close
```

We recommend enabling session-close logging within the pre-id-default-policy. This will ensure that security logs are generated by the SRX if a flow is unable to leave the pre-id-default-policy. These events are generally a result of Juniper Networks Deep Packet Inspection (JDPI) being unable to classify

traffic properly. The events might also indicate potential attempts at evading the application identification (AppID) engine.

Configuring the Session Timeout for the Default Security Policy

You can set the session timeout for the required sessions in default security policy configurations. You can specify the timeout values for UDP, TCP, ICMP, and ICMP6 sessions using the `set security policies pre-id-default-policy then session-timeout` command:

- Specify the timeout value in seconds for the TCP session:

```
[edit]
user@host# set security policies pre-id-default-policy then session-timeout tcp 1200
```

- Specify the timeout value in seconds for the UDP session:

```
[edit]
user@host# set security policies pre-id-default-policy then session-timeout udp 60
```

- Specify the timeout value in seconds for the ICMP session:

```
[edit]
user@host# set security policies pre-id-default-policy then session-timeout icmp 60
```

- Specify the timeout value in seconds for the ICMP6 session:

```
[edit]
user@host# set security policies pre-id-default-policy then session-timeout icmp6 120
```

Release History Table

Release	Description
18.2R1	Starting in Junos OS Release 18.2R1, unified policies are supported on SRX Series Firewalls, allowing granular control and enforcement of dynamic Layer 7 applications within the security policy. Unified policies are the security policies that enable you to use dynamic applications as match conditions as part of the existing 5-tuple or 6-tuple (5-tuple with user firewall) match conditions to detect application changes over time.

RELATED DOCUMENTATION

| [Flow-Based Sessions](#) | 52

TAP Mode for Flow Sessions

IN THIS SECTION

- [Understanding TAP Mode Support for Security Flow Sessions](#) | 104
- [Example: Configuring Security Flow Sessions in TAP mode](#) | 105

In TAP mode, an SRX Series Firewall will be connected to a mirror port of the switch, which provides a copy of the traffic traversing the switch. An SRX Series Firewall in TAP mode processes the incoming traffic from TAP interface and generates a security log to display the information on threats detected, application usage, and user details.

Understanding TAP Mode Support for Security Flow Sessions

Starting in Junos OS Release 18.3R1, TAP mode supports security flow sessions. The security flow session configuration remains the same as non-TAP mode. When you configure a device to operate in TAP mode, the device generates a security log information to display the information on threats detected, application usage, and user details according to the incoming traffic. TAP mode is enabled in flow status when there is a configured TAP interface.

Traffic with and without VLAN can be received by TAP interface. By default, on all devices, the `FLOW SYN-check` and `sequence-check` options are disabled at `[set security]` hierarchy level.

Starting in Junos OS Release 20.1R1, TAP mode can be used to inspect at most two levels of embedding IP-IP tunnels and one level of embedding GRE tunnel by de-encapsulating the outer and inner IP header and creating flow sessions. You can configure up to eight TAP interfaces on an SRX Series Firewall.

Example: Configuring Security Flow Sessions in TAP mode

IN THIS SECTION

- [Requirements | 105](#)
- [Overview | 105](#)
- [Configuration | 106](#)
- [Verification | 107](#)

This example shows how to configure security flow sessions when the SRX Series Firewall is configured in TAP mode.

Requirements

This example uses the following hardware and software components:

- An SRX Series Firewall
- Junos OS Release 19.1R1

Overview

In this example, you configure the security flow sessions when the SRX Series Firewall is configured in TAP mode. Sessions are created when a TCP SYN packet is received and permitted by the security policy.

Configuration

IN THIS SECTION

- [CLI Quick Configuration | 106](#)
- [Procedure | 106](#)
- [Results | 107](#)

CLI Quick Configuration

To quickly configure this example, copy the following commands, paste them into a text file, remove any line breaks, change any details necessary to match your network configuration, copy and paste the commands into the CLI at the [edit] hierarchy level, and then enter commit from configuration mode.

```
set security flow tcp-session no-syn-check
set security flow tcp-session no-sequence-check
```

Procedure

Step-by-Step Procedure

The following example requires you to navigate various levels in the configuration hierarchy. For instructions on how to do that, see *Using the CLI Editor in Configuration Mode* in the [CLI User Guide](#).

To configure security flow sessions in TAP mode:

1. Configure the security flow session.

```
user@host#set security flow tcp-session no-syn-check
user@host# set security flow tcp-session no-sequence-check
```

Results

From configuration mode, confirm your configuration by entering the `show security flow` command. If the output does not display the intended configuration, repeat the instructions in this example to correct the configuration.

```
[edit]
user@host# show security flow
  tcp-session {
    no-syn-check;
    no-sequence-check;
  }
```

If you are done configuring the device, enter `commit` from configuration mode.

Verification

IN THIS SECTION

- [Verifying Security Session Configuration in TAP Mode | 107](#)

To confirm that the configuration is working properly, perform these tasks:

Verifying Security Session Configuration in TAP Mode

Purpose

Verify information about security sessions.

Action

From operational mode, enter the `show security flow session` command.

```
user@host> show security flow session
node0:
-----

Flow Sessions on FPC4 PIC0:
```

Total sessions: 0

Flow Sessions on FPC4 PIC1:

Total sessions: 0

Meaning

Displays information about all currently active security sessions on the device in TAP mode.

SEE ALSO

| [TAP Mode Support Overview for UTM](#)

Release History Table

Release	Description
20.1R1	Starting in Junos OS Release 20.1R1, TAP mode can be used to inspect at most two levels of embedding IP-IP tunnels and one level of embedding GRE tunnel by de-encapsulating the outer and inner IP header and creating flow sessions.

Flow Management in SRX Series Devices Using VRF Routing Instance

IN THIS SECTION

- [Virtual Routing and Forwarding Instances in SD-WAN Deployments | 109](#)
- [Flow Management Using VRF Routing Instance | 110](#)
- [Virtual Routing and Forwarding Groups | 110](#)
- [Flow Processing using Virtual Routing and Forwarding Group | 116](#)

Virtual Routing and Forwarding Instances in SD-WAN Deployments

Virtual routing and forwarding (VRF) instances are required to separate the routes of each tenant from the route of other tenants and from other network traffic. SRX Series Firewalls use VRF instances for segmenting networks for increased security and improved manageability in SD-WAN deployments. For example, you can create distinct routing domains called tenants to segment large corporate networks and segment traffic to support multiple customer networks. Each tenant has its own routing table, which enables the support for overlapping IP subnets. VRF can be used to manage routes and to forward traffic based on independent forwarding tables in VRF for a specific tenant.

In an SD-WAN deployments, a provider edge (PE) router can be both a hub device and a spoke device that receives and forwards MPLS traffic. A customer edge (CE) router is an SRX Series Firewall that interacts with a PE router to transmit VPN traffic using VRF routing instances. The VRF instances forward each customer VPN traffic and each VRF instance contains one label to represent all the customer traffic that flows through that VRF.

Different sites that connect to a spoke-side SRX Series Firewall can belong to the same tenant or to the same VRF routing instance. These sites send the IP traffic that is intended to reach either public Internet or remote tenant sites.

When the traffic reaches the spoke-side SRX Series Firewall, the device identifies the VRF instance from the LAN interfaces that are connected to those sites. After security processing on this traffic, the traffic finds a route to the destination in that VRF routing table. If the destination is MPLS over next-hop-based generic routing encapsulation (GRE), the SRX Series Firewall adds a corresponding MPLS label and forwards the packet to the hub-side device.

At the hub-side device, after receiving MPLS over GRE tunneled traffic, the SRX Series Firewall associates the MPLS label to identify the corresponding VRF routing instance. After security processing of the traffic is complete, the device identifies whether the destination is on public Internet or reachable via MPLS next-hop.

If the destination is public Internet, Network Address Translation (NAT) converts VRF private IP address to a public IP address and establish the session. If the destination is a type of MPLS next-hop, corresponding MPLS label is added and the packet is forwarded to the remote spoke using a GRE overlay tunnel.

At the remote spoke side, after receiving the MPLS over GRE tunnel traffic, the device identifies the corresponding VRF routing-instance using the MPLS labels. Using that VRF routing instance, the SRX Series Firewall finds the correct destination LAN interface in that VRF to forward the packet to the destination.

Flow Management Using VRF Routing Instance

An SRX Series Firewall flow creates sessions based on 5-tuple data (source IP address, destination IP address, source port number, destination port number, and protocol number) along with interface tokens of input interface and output interface of traffic. For example, the routing instance VRF-1 and the routing instance VRF-2 have the same 5-tuple traffic that can enter and exit through the same physical GRE tunnel. When these overlapping IP addresses from the same tunnel enter or exit through the SRX Series Firewall, then SRX Series Firewall flow cannot install multiple sessions in the database because of the conflict in session information. Additional information is required for the SRX Series Firewall to differentiate sessions during the installation.

Starting in Junos OS Release 15.1X49-D160, SRX Series Firewalls can use VRF information from the MPLS-tagged packets in the session key to differentiate sessions. To differentiate sessions from different VRF instances, flow uses VRF identification numbers to the existing session key to identify each VRF instance. This session key is used as one of the matching criteria during session look-up.

You can use the following matching criteria along with existing 5-tuple matching conditions in a security policy to permit or deny traffic based on given VRF:

- **Source VRF**—This is the VRF routing instance associated with the incoming interface of the packet. When an incoming MPLS packet containing a label arrives at an SRX Series Firewall, the device decodes the label, and maps the label to the incoming interface.
- **Destination VRF**—This is the VRF routing instance associated with the final route to the destination. During the first packet processing for a new session, flow needs a destination route for routing a packet to the next-hop device or interface. Flow searches the initial routing table from either the incoming interface or from a separate RTT table until it finds the final next-hop device or interface. Once the final route entry is found, and if that route points to an MPLS next-hop device, then the destination VRF is assigned to the routing instance in which the final route is found.

Virtual Routing and Forwarding Groups

IN THIS SECTION

- [Understanding VRF groups | 112](#)
- [Types of VRF groups | 113](#)
- [VRF Movement | 113](#)
- [VRF group-ID | 114](#)

- [Configuring VRF groups | 114](#)
- [VRF group Operations | 115](#)

SD-WAN enterprise network is composed of multiple L3VPN networks as shown in [Figure 11 on page 111](#).

Figure 11: Multiple L3VPNs

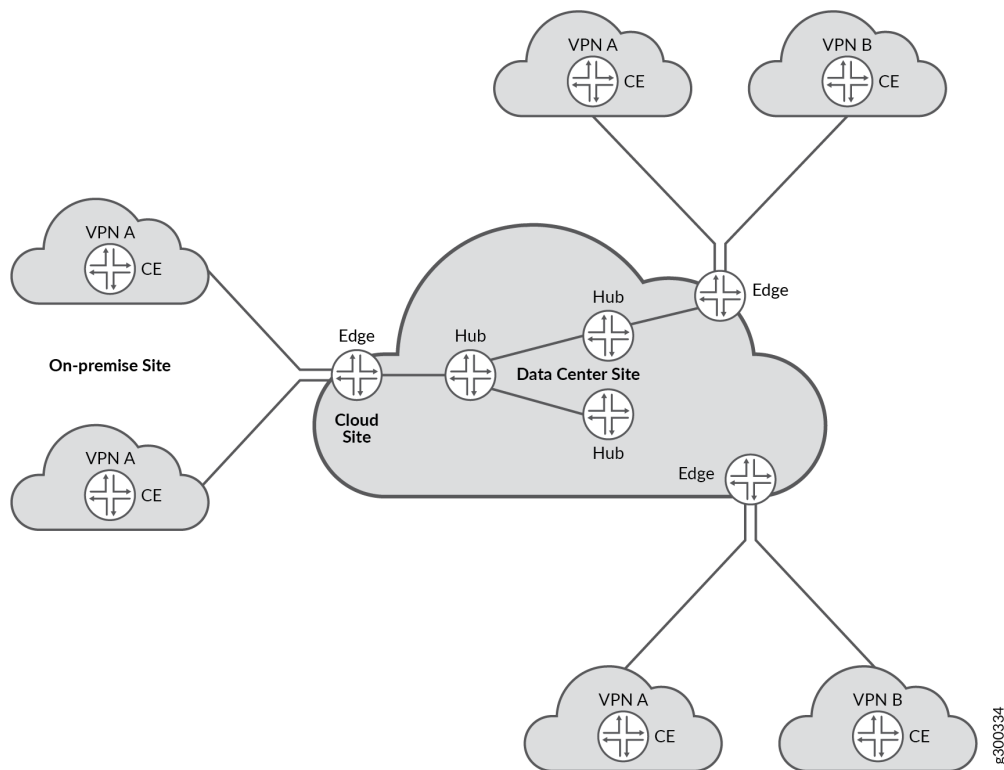

L3VPN networks are identified at a site (CPE device) as a set of VRF instances. The VRF instances at a site belonging to a L3VPN network at a site are used for application policy based forwarding. SRX flow session handling has enhanced to support mid-stream traffic switching between these VRF instances based on application based steering policies. The VRF instances which are logically part of a given L3VPN network can be configured as a VRF group. Existing firewall, NAT configuration commands have been enhanced to support operations on VRF group.

The [Figure 12 on page 112](#) describes how traffic steering within an L3VPN is done across multiple VRFs based on APBR policies.

Figure 12:

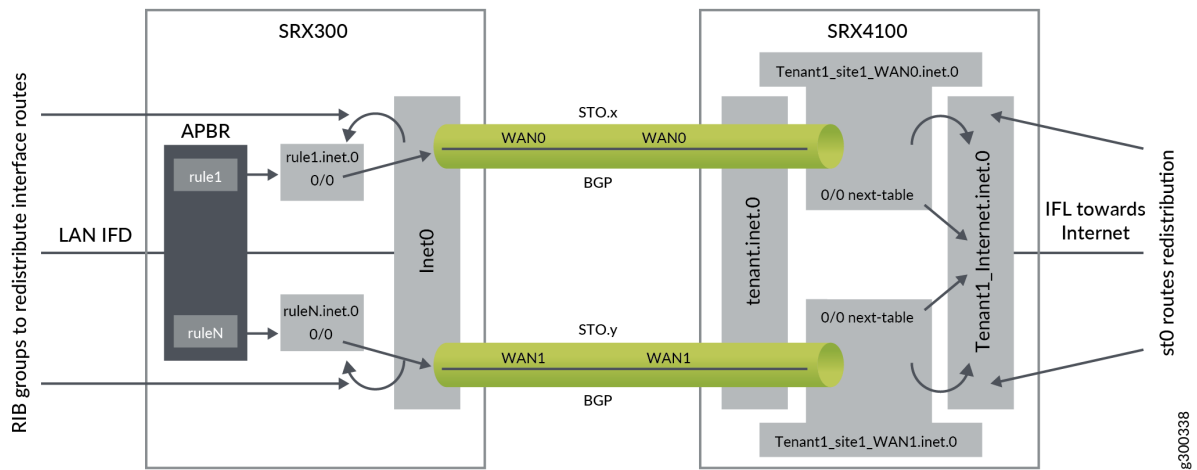

When you configure the VRF groups using VRF instances, a VRF group-ID is generated. These VRF groups are used in the following modules to control SD-WAN L3VPN:

- **Security Policy** - For policy control.
- **Flow** - To search policies based on VRF group names, along with source or destination zone, source or destination IP address, and protocol. Hence, sessions are created using VRF groups as one of differentiator.
- **NAT** - To support NAT rules based on VRF group names.
- **ALG** - To create ALG sessions using VRF groups as one of differentiator.

The functionality of the VRF groups:

- It allows a session to switch between two MPLS VRFs.
- When the VRF instances are part of the same VRF group, security features such as flow, policy, NAT, or ALG modules treat the VRF instances similarly.
- When you configure the VRF groups using VRF instances, a VRF group-ID is generated. This group-ID is stored in session for identifying the VRF group of a particular VRF instance.

Understanding VRF groups

VRF group is introduced to support L3VPN MPLS based sessions in SD-WAN network. It is used to control the MPLS L3VPN traffic in policy, flow, NAT and ALG modules when there are overlapping or no overlapping IP network addresses in the MPLS L3VPN network.

If the traffic pass between non MPLS L3VPN networks, VRF groups are not configured. When VRF groups are not configured, the VRF group-ID will be zero or the policy will use the option any for VRF group.

The purpose of VRF groups is:

- To differentiate L3VPN sessions between MPLS L3VPN network.
- To have policy and NAT control between MPLS L3VPN network.

Types of VRF groups

There are two important VRF group in L3VPN network are:

- Source-VRF group
- Destination-VRF group

To understand which VRF instances can be grouped together for Source-VRF group or Destination-VRF group, use the following information:

- **Source-VRF instances**—List of VRF instances that negotiates different MPLS paths to the same inbound destination.
- **Destination-VRF instances**— List of VRF instances that contain the destination routes for a given L3VPN traffic.

NOTE: If the traffic is initiated in the opposite direction, the VRF groups switch roles with respect to the direction of the traffic.

VRF Movement

From [Figure 13 on page 114](#), the initial traffic flow for a session establishment is from left to right. The traffic enters GRE-Zone1, then enters Source-VRF group (A) and passes through Destination-VRF group (A') before it exits through GRE_Zone2.

Similarly, the policy search is initiated from GRE_Zone1->Source-VRF group(A)->Destination-VRF group->(A')->GRE_Zone2 and the flow sessions is set-up, using Source-VRF group (A) and Destination-VRF group (A) as an additional key values in sessions. When the flow sessions are done using VRF groups, traffic can switch (re-route) from one VRF to another VRF within Group.

Figure 13: VRF Movement within VRF Group

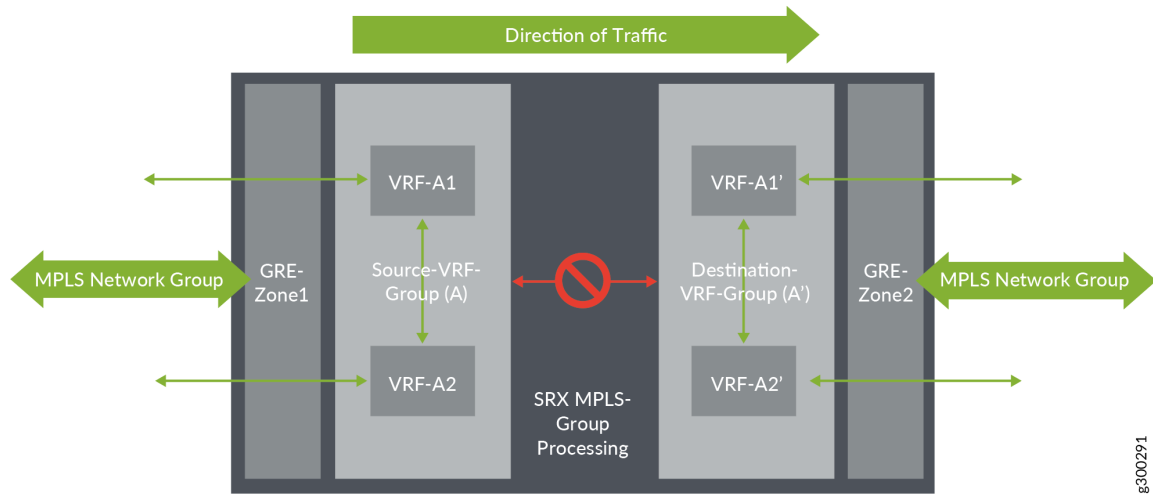

VRF group-ID

For storing the VRF group-ID, a 16-bits number is used in a session key data structure.

Configuring VRF groups

To configure a VRF group, use the following steps:

- List the VRF instances that needs to be grouped.
- Assign a name to the VRF group.
- Apply the VRF instances and the VRF group name in the CLI command set `security l3vpn vrf-group group-name vrf vrf1 vrf vrf2`

The source and destination VRF groups are configured separately based on different context.

- **Source VRF group**—The source VRF group for routing-instance is associated with MPLS packet. When the device receives a MPLS packet, the packet is decoded and mapped to LSI interface. The LSI interface contains the routing table information that helps in identifying the VRF group details.
- **Destination VRF group**—During first-path flow processing of packet for a new session, the destination route information is required to route the packet to the next-hop or interface. Flow searches the routing table to get the route information. When the received route information points to MPLS as next-hop, then the VRF of this route is used to identify the destination VRF group.

NOTE: The source and destination VRF groups are same in some cases when you prefer to control all the related VRFs in a L3VPN network.

VRF group Operations

IN THIS SECTION

- [Adding VRF to a VRF group | 115](#)
- [Removing VRF from a VRF group | 115](#)
- [Modifying VRF group | 116](#)
- [Removing VRF group | 116](#)

When a VRF group is configured, a Group-ID is created which is unique for different VRF groups. You can perform different operations such as adding, removing, or modifying a VRF to a VRF group.

Adding VRF to a VRF group

When a VRF is added to a VRF group, the corresponding VRF group-ID is assigned to the VRF. When you add a VRF to VRF group, remember the following:

- A VRF can be added to only one VRF group. It cannot be a part of multiple VRF groups.
- A maximum of 32 VRFs are be configured in a VRF group.
- When a VRF is added, it impacts the existing session and a new session is created as per policy.
- When new sessions are created after adding a new VRF to VRF group, the sessions use the new VRF group-ID of the new VRF.

Removing VRF from a VRF group

When a VRF is removed from a VRF group, the VRF group-ID of that VRF group changes to zero but the VRF will still be available in the device. When you remove a VRF from a VRF group, it impacts the existing sessions in two ways:

- **Impacting existing sessions**—When a VRF is removed from the VRF group, the existing session is removed and a new session will be created as per policy

- **Match Traffic**—When a VRF is removed from VRF group, the VRF group-ID for that VRF changes to zero and hence will not match the session. The packet drops and a new session is created as per policy.

When a VRF is removed from the VRF group, the new session that is processed using the impacted VRF installs a new VRF group-ID. This VRF group-ID will be zero, or a new Group-ID is created if you add the VRF to a new VRF group

Modifying VRF group

Modifying a VRF group involves the following operations:

- **Changing VRF group name:** When you change the VRF group name, the policy module scans the existing sessions to verify if the new VRF group name matches the existing rules.
- **Adding VRF to VRF group:** When a VRF is added to a VRF group, the corresponding VRF group-ID is assigned to the VRF.
- **Removing VRF from VRF group:** When a VRF is removed from a VRF group, the VRF group-ID of that VRF changes to zero and still the VRF will be available in the device.

Removing VRF group

When you remove a VRF group using CLI, a session scan will be performed on the existing sessions to match the VRF group that is removed. If the session match the removed VRF group, then that session is removed from the device by setting an invalid timeout. For sessions that does not match the removed VRF-Group-ID are not impacted.

RELATED DOCUMENTATION

| [Flow Processing using Virtual Routing and Forwarding Group](#)

Flow Processing using Virtual Routing and Forwarding Group

IN THIS SECTION

- [First Path Processing using VRF Group | 117](#)
- [Fast Path Processing using VRF Group | 118](#)

- Example: Configuring a Security Policy to Permit VRF-Based Traffic from an IP Network to MPLS Network using VRF Group | 119
- Example: Configuring a Security Policy to Permit VRF-Based Traffic from MPLS Network to an IP Network using VRF Group | 125
- Example: Configuring a Security Policy to Permit VRF-Based Traffic from Public IP Network to MPLS Network using VRF Group | 130
- Example: Configuring a Security Policy to Permit VRF-Based Traffic from MPLS Network to Public IP Network to using VRF Group | 138
- Example: Configuring a Security Policy to Permit VRF-Based Traffic from MPLS Network to MPLS Network without NAT using VRF Group | 146
- Example: Configuring a Security Policy to Permit VRF-Based Traffic from MPLS Network to MPLS Network using NAT and VRF Group | 151
- Multicast Support in SD-WAN Deployments | 159

First Path Processing using VRF Group

To process a packet, the first path processing performs the following:

- **MPLS Decoder**—When flow receives a MPLS or non-MPLS packet, the packet is processed to retrieve the details of the incoming packet, interface, and routing-instance of the incoming interface.
- **FBF configuration**—When you configure FBF rules to re-direct the incoming packets to different routing-instance, the FBF rule finds the routing-instance information and pass the FBF routing-instance information instead of packet incoming interface routing-instance. This FBF VRF should be a part of VRF group to control the L3VPN network.
- **Initialize Routing-Table**—When the flow receives the packet, the initial routing-table for the packet is created. If the FBF configuration matches the firewall filters, then the routing-instance information from FBF is used for route look-up. Else, flow uses the incoming interface routing-instance information for route look-up.
- **Finding Source VRF group**—If the incoming packet is from MPLS network, then the packet is mapped to the VRF instance of source VRF group. If the incoming packet is not MPLS packet, then the source VRF group id is zero.
- **Destination NAT using VRF group**—Flow checks if the destination IP needs NAT translation. Destination NAT supports two types of match criteria for VRF:
 - NAT rule search using VRF routing-group.
 - NAT rule result using VRF routing-instance and NAT information.

- **Destination Route**—The route look-up which is done in initial route table is used to identify the outgoing interface and destination-VRF information. This information is used in policy search and session installation.
- **Final next-hop**—The first step in finding destination route is to find final the next-hop of the pointed route. Using this next-hop, flow will check if the next-hop points to MPLS network or not. If it is not pointing to MPLS network, the destination VRF group will be zero.
- **Destination VRF group**— When the destination VRF is identified, the destination VRF Group-ID is initialized. If the destination VRF is not assigned to any group, it is set to zero.
- **First Path Policy Search**—Flow performs policy search to check if the packet needs to be permitted or denied. Flow gathers the 5-tuple policy-key information and VRF information and this information is used by policy search module to find the appropriate VRF policy.
- **Source NAT using VRF group**—Flow session does source NAT using source VRF group NAT rule search. Source-NAT supports two types of NAT search criteria.
 - Source-NAT rule search using VRF group.
 - Static-NAT rule search using VRF group or VRF instance.
- **Static NAT using VRF group or VRF instance**—Static NAT supports routing-group in rule-set and routing-instance in rule with VRF type.
 - When static NAT matches as destination NAT translation for a given IP packet, the VRF routing-group will be one of the match criteria and the VRF routing-instance will be used as destination routing table.
 - When static NAT matches as source NAT translation for a given IP packet, the VRF routing-instance will be one of the match criteria.
- **Session Installation using VRF group**—During session installation process, source VRF group-ID is stored in forward-wing indicating that the wing points MPLS network. The destination VRF group-ID that is found from route look-up is stored in reverse-wing indicating that the wing points MPLS network.
- **Re-routing using VRF group**—Once the session is established using VRF group information, re-route is initiated if the interface is down or initial route is not available. These changed routes should be part of same VRF group (Source-VRF group/Destination-VRF group), in which the session is initially established on either side. Else, traffic will not match session and future traffic of session might get dropped or create new sessions as per policy.

Fast Path Processing using VRF Group

The fast path processing performs the following steps to process a packet.

- **MPLS Decoder**—When a packet MPLS or non-MPLS packet is received, the packet undergoes MPLS processing. When the processing is complete, the flow receives the details of the incoming packet, interface, and routing-instance of the incoming interface.
- **FBF configuration**—When you configure FBF rules to re-direct the incoming packets to different routing-instance, the FBF rule finds the routing-instance information and pass the FBF routing-instance information instead of packet incoming interface routing-instance. This FBF VRF should be a part of VRF group to control the L3VPN network.
- **Session look-up using VRF Group-ID**—During session look-up process, flow checks whether to pass the VRF Group-ID in session key for look-up. If the incoming interface is MPLS, flow will pass the VRF Group-ID information of the mapped VRF routing-instance to session key along with other key tuple information. If the incoming interface is not MPLS, the VRF Group-ID will be zero.
- **Session Route change**—If the route changes for session in mid-stream, flow checks for the new VRF that belongs to this route. If the new VRF Group-ID differs from the VRF Group-ID of the session, then the route will not be processed and the future packets are dropped. Hence, for re-routing the new route should belong to a VRF that belongs to session VRF Group.
- **VRF Group policy change**—When VRF group session policy is changed due to policy attributes such as zone/interface/IP/Source-VRF group/Destination-VRF group, the policy will be re-matched for the same session by supplying policy 5-tuple along with source VRF group and destination VRF group values to check if the policy is valid or not. Upon re-match, if policy does not match the session information, then the session terminates.
- **VRF session display**—Source-VRF Group and Destination-VRF Group are displayed in session output display to differentiate different VRF group for the same tuple.
- **High Availability**—High availability is supported with no behavior change when additional VRF group-ID information is synchronized to the HA peer node for differentiating different VRF group in the session

Example: Configuring a Security Policy to Permit VRF-Based Traffic from an IP Network to MPLS Network using VRF Group

IN THIS SECTION

- [Requirements | 120](#)
- [Overview | 120](#)
- [Configuration | 121](#)

This example shows how to configure a security policy to permit traffic from a private IP network to MPLS network using VRF group.

Requirements

- Supported SRX Series Firewall with Junos OS Release 15.1X49-D170 or later. This configuration example is tested for Junos OS Release 15.1X49-D170.

Overview

In Junos OS, security policies enforce rules for transit traffic, in terms of what traffic can pass through the device and the actions that need to take place on the traffic as it passes through the device. In Figure 4, an SRX Series Firewall is deployed in an SD-WAN to permit the traffic from a private IP network to MPLS network using VRF group.

Figure 14: Traffic from Private Network to MPLS

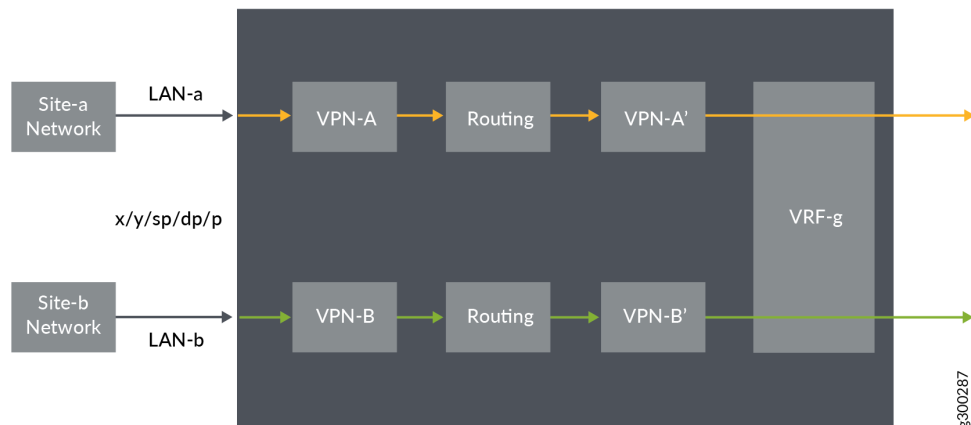

This configuration example shows how to:

- Permit traffic from IP network (LAN-a) to VRF group
- Permit traffic from IP network (LAN-b) to VRF group

Configuration

IN THIS SECTION

- [Verification | 124](#)

Procedure

CLI Quick Configuration

To quickly configure this example, copy the following commands, paste them into a text file, remove any line breaks, change any details necessary to match your network configuration, copy and paste the commands into the CLI at the [edit] hierarchy level, and then enter `commit` from configuration mode.

```

set security l3vpn vrf-group vpn-A vrf VRF-A1
set security l3vpn vrf-group vpn-A vrf VRF-A2
set security l3vpn vrf-group vpn-A1 vrf VRF-A11
set security l3vpn vrf-group vpn-A1 vrf VRF-A21
set security l3vpn vrf-group vpn-B vrf VRF-B1
set security l3vpn vrf-group vpn-B vrf VRF-B2
set security l3vpn vrf-group vpn-B1 vrf VRF-B11
set security l3vpn vrf-group vpn-B1 vrf VRF-B21
set security policies from-zone LAN-a_Zone to-zone GRE_Zone policy vrf-a_policy match source-
address any
set security policies from-zone LAN-a_Zone to-zone GRE_Zone policy vrf-a_policy match
destination-address any
set security policies from-zone LAN-a_Zone to-zone GRE_Zone policy vrf-a_policy match
application any
set security policies from-zone LAN-a_Zone to-zone GRE_Zone policy vrf-a_policy match
destination-l3vpn-vrf-group vpn-A1
set security policies from-zone LAN-a_Zone to-zone GRE_Zone policy vrf-a_policy then permit
set security policies from-zone LAN-b_Zone to-zone GRE_Zone policy vrf-b_policy match source-
address any
set security policies from-zone LAN-b_Zone to-zone GRE_Zone policy vrf-b_policy match
destination-address any
set security policies from-zone LAN-b_Zone to-zone GRE_Zone policy vrf-b_policy match
application any
set security policies from-zone LAN-b_Zone to-zone GRE_Zone policy vrf-b_policy match

```

```
destination-l3vpn-vrf-group vpn-B1
set security policies from-zone LAN-b_Zone to-zone GRE_Zone policy vrf-b_policy then permit
```

Step-by-Step Procedure

The following example requires you to navigate various levels in the configuration hierarchy. For instructions on how to do that, see *Using the CLI Editor in Configuration Mode* in the [CLI User Guide](#).

1. Create VRF group vpn-A with VRF instances A1 and A2

```
[edit security]
user@host# set l3vpn vrf-group vpn-A vrf VRF-A1
user@host# set l3vpn vrf-group vpn-A vrf VRF-A2
```

2. Create VRF group vpn-A1 with VRF instances A11, and A21

```
[edit security]
user@host# set l3vpn vrf-group vpn-A1 vrf VRF-A11
user@host# set l3vpn vrf-group vpn-A1 vrf VRF-A21
```

3. Create VRF group vpn-B with VRF instances B1 and B2

```
[edit security]
user@host# set l3vpn VRF group vpn-B vrf VRF-B1
user@host# set l3vpn VRF group vpn-B vrf VRF-B2
```

4. Create VRF group vpn-B1 with VRF instances B11 and B21

```
[edit security]
user@host# set l3vpn vrf-group vpn-B1 vrf VRF-B11
user@host# set l3vpn vrf-group vpn-B1 vrf VRF-B21
```

5. Create a security policy to permit vrf-a traffic.

```
[edit security policies from-zone LAN-a_Zone to-zone GRE_Zone]
user@host# set policy vrf-a_policy match source-address any
user@host# set policy vrf-a_policy match destination-address any
user@host# set policy vrf-a_policy match application any
```

```

user@host# set policy vrf-a_policy match destination-l3vpn-vrf-group vpn-A1
user@host# set policy vrf-a_policy then permit

```

6. Create a security policy to permit vrf-b traffic.

```

[edit security policies from-zone LAN-a_Zone to-zone GRE_Zone]
user@host# set policy vrf-b_policy match source-address any
user@host# set policy vrf-b_policy match destination-address any
user@host# set policy vrf-b_policy match application any
user@host# set policy vrf-b_policy match destination-l3vpn-vrf-group vpn-B1
user@host# set policy vrf-b_policy then permit

```

Results

From configuration mode, confirm your configuration by entering the `show security policies` command. If the output does not display the intended configuration, repeat the configuration instructions in this example to correct it.

```

[edit]
user@host# show security policies
from-zone LAN-a_Zone to-zone GRE_Zone {
  policy vrf-a_policy {
    match {
      source-address any;
      destination-address any;
      application any;
      source-l3vpn-VRF group vpn-A1;
    }
    then {
      permit;
    }
  }
}
from-zone LAN-b_Zone to-zone GRE_Zone {
  policy vrf-b_policy {
    match {
      source-address any;
      destination-address any;
      application any;
      source-l3vpn-VRF group vpn-B1;
    }
  }
}

```

```

    then {
        permit;
    }
}
}

```

If you are done configuring the device, enter `commit` from configuration mode.

Verification

IN THIS SECTION

- [Verifying Policy Configuration | 124](#)

Verifying Policy Configuration

Purpose

Verify information about security policies.

Action

From operational mode, enter the `show security policies` command to display a summary of all the security policies configured on the device.

```

user@root> show security policies
Default policy: permit-all
From zone: LAN-a_Zone, To zone: GRE_Zone
  Policy: vrf-a_policy, State: enabled, Index: 4, Scope Policy: 0, Sequence number: 1
    Source L3VPN vrf-group: vpn-A1
    destination L3VPN VRF Group: any
    Source addresses: any
    Destination addresses: any
    Applications: any
    Action: permit
From zone: LAN-b_Zone, To zone: GRE_Zone
  Policy: vrf-b_policy, State: enabled, Index: 5, Scope Policy: 0, Sequence number: 2
    Source L3VPN vrf-group: vpn-B1
    destination L3VPN VRF Group: any
    Source addresses: any

```

Destination addresses: any
Applications: any
Action: permit

Example: Configuring a Security Policy to Permit VRF-Based Traffic from MPLS Network to an IP Network using VRF Group

IN THIS SECTION

- [Requirements | 125](#)
- [Overview | 125](#)
- [Configuration | 126](#)

This example shows how to configure a security policy to permit traffic from MPLS to IP network using the VRF group.

Requirements

- Supported SRX Series Firewall with Junos OS Release 15.1X49-D170 or later. This configuration example is tested for Junos OS Release 15.1X49-D170.
- Configure network interfaces on the device. See [Interfaces User Guide for Security Devices](#).

Overview

In Junos OS, security policies enforce rules for transit traffic, in terms of what traffic can pass through the device and the actions that need to take place on the traffic as it passes through the device. In Figure 5, an SRX Series Firewall is deployed in an SD-WAN to permit traffic from a MPLS network to private network using VRF group.

Figure 15: Traffic Permit from MPLS to Private Network

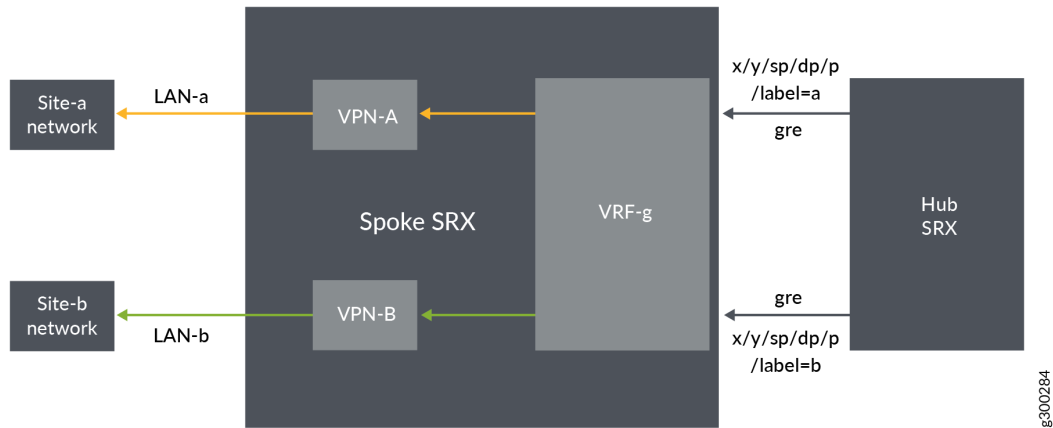

This configuration example shows how to:

- Permit traffic from GRE MPLS to LAN-a
- Permit traffic from GRE MPLS to LAN-b

Configuration

IN THIS SECTION

- [Verification | 129](#)

Procedure

CLI Quick Configuration

To quickly configure this example, copy the following commands, paste them into a text file, remove any line breaks, change any details necessary to match your network configuration, copy and paste the commands into the CLI at the [edit] hierarchy level, and then enter `commit` from configuration mode.

```
set security l3vpn vrf-group vpn-A vrf VRF-A1
set security l3vpn vrf-group vpn-A vrf VRF-A2
```

```

set security l3vpn vrf-group vpn-B vrf VRF-B1
set security l3vpn vrf-group vpn-B vrf VRF-B2
set security policies from-zone GRE_Zone to-zone LAN-a_Zone policy vrf-a_policy match source-
address any
set security policies from-zone GRE_Zone to-zone LAN-a_Zone policy vrf-a_policy match
destination-address any
set security policies from-zone GRE_Zone to-zone LAN-a_Zone policy vrf-a_policy match
application any
set security policies from-zone GRE_Zone to-zone LAN-a_Zone policy vrf-a_policy match source-
l3vpn-vrf-group vpn-A
set security policies from-zone GRE_Zone to-zone LAN-a_Zone policy vrf-a_policy then permit
set security policies from-zone GRE_Zone to-zone LAN-b_Zone policy vrf-b_policy match source-
address any
set security policies from-zone GRE_Zone to-zone LAN-b_Zone policy vrf-b_policy match
destination-address any
set security policies from-zone GRE_Zone to-zone LAN-b_Zone policy vrf-b_policy match
application any
set security policies from-zone GRE_Zone to-zone LAN-b_Zone policy vrf-b_policy match source-
l3vpn-vrf-group vpn-B
set security policies from-zone GRE_Zone to-zone LAN-b_Zone policy vrf-b_policy then permit

```

Step-by-Step Procedure

The following example requires you to navigate various levels in the configuration hierarchy. For instructions on how to do that, see *Using the CLI Editor in Configuration Mode* in the [CLI User Guide](#).

1. Create VRF group vpn-A with VRF instances A1 and A2.

```

[edit security]
user@host# set l3vpn vrf-group vpn-A vrf VRF-A1
user@host# set l3vpn vrf-group vpn-A vrf VRF-A2

```

2. Create VRF group vpn-B with VRF instances B1 and B2.

```

[edit security]
user@host# set l3vpn vrf-group vpn-B vrf VRF-B1
user@host# set l3vpn vrf-group vpn-B vrf VRF-B2

```

3. Create a security policy to permit VRF-a traffic.

```
[edit security policies from-zone GRE_Zone to-zone LAN-a_Zone]
user@host# set policy vrf-a_policy match source-address any
user@host# set policy vrf-a_policy match destination-address any
user@host# set policy vrf-a_policy match application any
user@host# set policy vrf-a_policy match source-l3vpn-vrf-group vpn-A
user@host# set policy vrf-a_policy then permit
```

4. Create a security policy to permit VRF-b traffic.

```
[edit security policies from-zone GRE_Zone to-zone LAN-b_Zone]
user@host# set policy vrf-b_policy match source-address any
user@host# set policy vrf-b_policy match destination-address any
user@host# set policy vrf-b_policy match application any
user@host# set policy vrf-b_policy match destination-l3vpn-vrf-group vpn-B
user@host# set policy vrf-b_policy then permit
```

Results

From configuration mode, confirm your configuration by entering the `show security policies` command. If the output does not display the intended configuration, repeat the configuration instructions in this example to correct it.

```
[edit]
user@host# show security policies
from-zone GRE_Zone to-zone LAN-a_Zone {
  policy vrf-a_policy {
    match {
      source-address any;
      destination-address any;
      application any;
      destination-l3vpn-vrf-group vpn-A;
    }
    then {
      permit;
    }
  }
}
from-zone GRE_Zone to-zone LAN-b_Zone {
  policy vrf-b_policy {
```



```

    match {
        source-address any;
        destination-address any;
        application any;
        destination-l3vpn-vrf-group vpn-B;
    }
    then {
        permit;
    }
}
}
}

```

If you are done configuring the device, enter `commit` from configuration mode.

Verification

IN THIS SECTION

- [Verifying Policy Configuration | 129](#)

Verifying Policy Configuration

Purpose

Verify information about security policies.

Action

From operational mode, enter the `show security policies` command to display a summary of all the security policies configured on the device.

```

user@root> show security policies
Default policy: permit-all
From zone: GRE_Zone, To zone: LAN-a_Zone
Policy: vrf-a_policy, State: enabled, Index: 4, Scope Policy: 0, Sequence number: 1
  Source L3VPN VRF-Group: any
  destination L3VPN VRF Group: vpn-A
  Source addresses: any
  Destination addresses: any
  Applications: any

```

```

Action: permit
From zone: GRE_Zone, To zone: LAN-b_Zone
Policy: vrf-b_policy, State: enabled, Index: 5, Scope Policy: 0, Sequence number: 2
Source L3VPN VRF Group: any
destination L3VPN VRF-Group: vpn-B
Source addresses: any
Destination addresses: any
Applications: any
Action: permit

```

Example: Configuring a Security Policy to Permit VRF-Based Traffic from Public IP Network to MPLS Network using VRF Group

IN THIS SECTION

- [Requirements | 130](#)
- [Overview | 130](#)
- [Configuration | 131](#)
- [Verification | 136](#)

This example describes how to configure the destination NAT rule to translate incoming public IP network to MPLS network using VRF group.

Requirements

- Understand how SRX Series Firewalls work in an SD-WAN deployment for NAT.
- Understand Virtual Routing and Forwarding Instances. See ["Virtual Routing and Forwarding Instances in SD-WAN Deployments"](#) on page 109.

Overview

In Figure 6, an SRX Series Firewall is configured with destination NAT rule to translate incoming public IP network to per VRF based destination routing table and IP. The SRX Series Firewall is configured with two VRF groups, vpn-A and vpn-B.

Figure 16: Traffic Permit from Public Network to MPLS

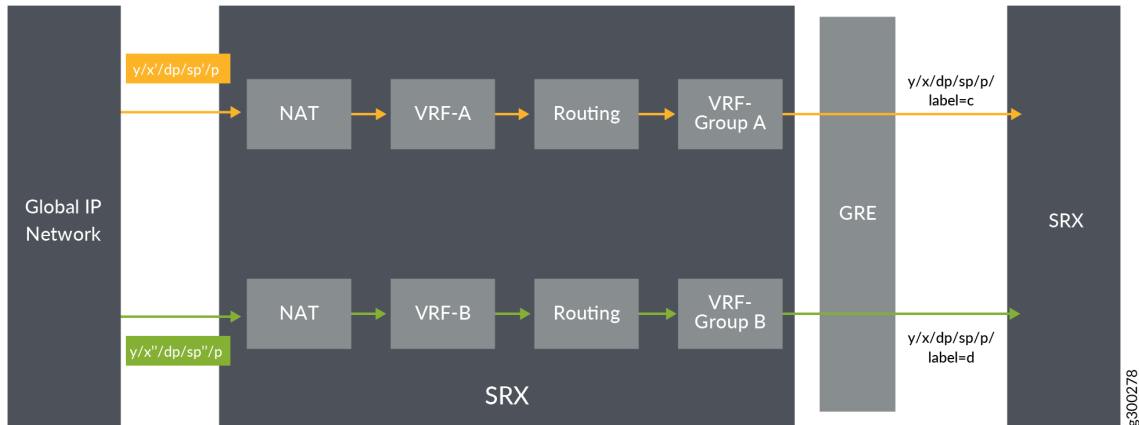

Configuration

IN THIS SECTION

- Procedure | 131
- Results | 134

Procedure

CLI Quick Configuration

To quickly configure this example, copy the following commands, paste them into a text file, remove any line breaks, change any details necessary to match your network configuration, copy and paste the commands into the CLI at the [edit] hierarchy level, and then enter `commit` from configuration mode.

```
set security l3vpn vrf-group vpn-A vrf VRF-A1
set security l3vpn vrf-group vpn-A vrf VRF-A2
set security l3vpn vrf-group vpn-B vrf VRF-B1
set security l3vpn vrf-group vpn-B vrf VRF-B2
set security nat destination pool vrf-a_p routing-instance VRF-a
set security nat destination pool vrf-a_p address 192.168.1.200
```

```

set security nat destination rule-set rs from interface ge-0/0/1.0
set security nat destination rule-set rs rule vrf-a_r match destination-address 203.0.113.200
set security nat destination rule-set rs rule vrf-a_r then destination-nat pool vrf-a_p
set security nat destination pool vrf-b_p routing-instance VRF-b
set security nat destination pool vrf-b_p address 192.168.1.201
set security nat destination rule-set rs from interface ge-0/0/1.1
set security nat destination rule-set rs rule vrf-b_r match destination-address 203.0.113.201
set security nat destination rule-set rs rule vrf-b_r then destination-nat pool vrf-b_p
set security policies from-zone GE_Zone to-zone GRE_Zone policy vrf-a_policy match source-
address any
set security policies from-zone GE_Zone to-zone GRE_Zone policy vrf-a_policy match destination-
address any
set security policies from-zone GE_Zone to-zone GRE_Zone policy vrf-a_policy match application
any
set security policies from-zone GE_Zone to-zone GRE_Zone policy vrf-a_policy match source-l3vpn-
vrf-group vpn-A
set security policies from-zone GE_Zone to-zone GRE_Zone policy vrf-a_policy then permit
set security policies from-zone GE_Zone to-zone GRE_Zone policy vrf-b_policy match source-
address any
set security policies from-zone GE_Zone to-zone GRE_Zone policy vrf-b_policy match destination-
address any
set security policies from-zone GE_Zone to-zone GRE_Zone policy vrf-b_policy match application
any
set security policies from-zone GE_Zone to-zone GRE_Zone policy vrf-b_policy match source-l3vpn-
vrf-group vpn-B
set security policies from-zone GE_Zone to-zone GRE_Zone policy vrf-b_policy then permit

```

Step-by-Step Procedure

The following example requires you to navigate various levels in the configuration hierarchy. For instructions on how to do that, see *Using the CLI Editor in Configuration Mode* in the [CLI User Guide](#).

To configure destination NAT mapping for a single VRF:

1. In Layer 3 VPNs create a VRF group vpn-A with VRF instances A1 and A2.

```

[edit security]
user@host#set l3vpn vrf-group vpn-A vrf VRF-A1
user@host#set l3vpn vrf-group vpn-A vrf VRF-A2

```

2. Create another VRF group vpn-B with VRF instances B1 and B2.

```
[edit security]
user@host# set l3vpn vrf-group vpn-B vrf VRF-B1
user@host# set l3vpn vrf-group vpn-B vrf VRF-B2
```

3. Specify a destination NAT IP address pool.

```
[edit security nat destination]
user@host# set pool vrf-a_p address 192.168.1.200
user@host# set pool vrf-b_p address 192.168.1.201
```

4. Assign the routing instance to the destination pool.

```
[edit security nat destination]
user@host# set pool vrf-a_p routing-instance VRF-a
user@host# set pool vrf-b_p routing-instance VRF-b
```

5. Create a destination NAT rule set.

```
[edit security nat destination]
user@host# set rule-set rs from routing-group vpn-A
user@host# set rule-set rs from routing-group vpn-B
user@host# set rule-set rs from interface ge-0/0/1.0
user@host# set rule-set rs from interface ge-0/0/1.1
```

6. Configure a rule that matches packets and translates the destination IP address to an IP address in the destination NAT IP address pool.

```
[edit security nat destination]
user@host# set rule-set rs rule vrf-a_r match destination-address 203.0.113.200
user@host# set rule-set rs rule vrf-a_r then destination-nat pool vrf-a_p
user@host# set rule-set rs rule vrf-b_r match destination-address 203.0.113.201
user@host# set rule-set rs rule vrf-b_r then destination-nat pool vrf-b_p
```

7. Create a security policy to permit VRF-a traffic.

```
[edit security policies from-zone GE_Zone to-zone GRE_Zone]
user@host# set policy vrf-a_policy match source-address any
user@host# set policy vrf-a_policy match destination-address any
user@host# set policy vrf-a_policy match application any
user@host# set policy vrf-a_policy match destination-l3vpn-vrf-group vpn-A
user@host# set policy vrf-a_policy then permit
```

8. Create a security policy to permit VRF-b traffic.

```
[edit security policies from-zone GE_Zone to-zone GRE_Zone]
user@host# set policy vrf-b_policy match source-address any
user@host# set policy vrf-b_policy match destination-address any
user@host# set policy vrf-b_policy match application any
user@host# set policy vrf-b_policy match destination-l3vpn-vrf-group vpn-B
user@host# set policy vrf-b_policy then permit
```

Results

From configuration mode, confirm your configuration by entering the `show security nat` and `show security policies` commands. If the output does not display the intended configuration, repeat the configuration instructions in this example to correct it.

```
[edit]
user@host# show security nat
  destination {
    pool vrf-a_p {
      routing-instance {
        VRF-a;
      }
      address 192.168.1.200/32;
    }
    pool vrf-b_p {
      routing-instance {
        VRF-b;
      }
      address 192.168.1.201/32;
    }
  }
rule-set rs {
```

```

from interface [ ge-0/0/1.0 ge-0/0/1.1 ];
rule vrf-a_r {
    match {
        destination-address 203.0.113.200/32;
    }
    then {
        destination-nat {
            pool {
                vrf-a_p;
            }
        }
    }
}
rule vrf-b_r {
    match {
        destination-address 203.0.113.201/32;
    }
    then {
        destination-nat {
            pool {
                vrf-b_p;
            }
        }
    }
}
}
}

```

[edit]

user@host# **show security policies**

```

from-zone GE_Zone to-zone GRE_Zone {
    policy vrf-a_policy {
        match {
            source-address any;
            destination-address any;
            application any;
            destination-l3vpn-vrf-group vpn-A;
        }
        then {
            permit;
        }
    }
}

```

```

}
policy vrf-b_policy {
  match {
    source-address any;
    destination-address any;
    application any;
    destination-l3vpn-vrf-group vpn-B;
  }
  then {
    permit;
  }
}

```

If you are done configuring the device, enter `commit` from configuration mode.

Verification

IN THIS SECTION

- [Verifying Destination NAT Rule Usage and Security Policies | 136](#)

Verifying Destination NAT Rule Usage and Security Policies

Purpose

Verify that there is traffic matching the destination NAT rule.

Action

From operational mode, enter the `show security nat destination rule all` command. In the Translation hits field, verify whether there is traffic that matches the destination NAT rule.

```

user@host> show security nat destination rule all
Total destination-nat rules: 2
Total referenced IPv4/IPv6 ip-prefixes: 2/0
Destination NAT rule: vrf-a_r          Rule-set: rs
  Rule-Id                : 1
  Rule position          : 1

```



```

From interface           : ge-0/0/1.0
Destination addresses    : 203.0.113.200 - 203.0.113.200
Action                   : vrf-a_p
Translation hits         : 0
  Successful sessions    : 0
  Failed sessions       : 0
Number of sessions      : 0
  Destination NAT rule   : vrf-b_r
Rule-set                 : rs
Rule-Id                  : 2
Rule position            : 2
From interface           : ge-0/0/1.1
Destination addresses    : 203.0.113.201 - 203.0.113.201
Action                   : vrf-b_p
Translation hits         : 0
  Successful sessions    : 0
  Failed sessions       : 0
Number of sessions      : 0

```

From operational mode, enter the `show security policies` command to display a summary of all the security policies configured on the device.

```

user@root> show security policies
Default policy: permit-all
From zone: GE_Zone, To zone: GRE_Zone
Policy: vrf-a_policy, State: enabled, Index: 4, Scope Policy: 0, Sequence number: 1
  Source L3VPN VRF Group: any
  destination L3VPN VRF-Group: vpn-A
  Source addresses: any
  Destination addresses: any
  Applications: any
  Action: permit
From zone: GE_Zone, To zone: GRE_Zone
Policy: vrf-b_policy, State: enabled, Index: 5, Scope Policy: 0, Sequence number: 2
  Source L3VPN VRF Group: any
  destination L3VPN VRF-Group: vpn-B
  Source addresses: any
  Destination addresses: any
  Applications: any
  Action: permit

```

Example: Configuring a Security Policy to Permit VRF-Based Traffic from MPLS Network to Public IP Network to using VRF Group

IN THIS SECTION

- Requirements | 138
- Overview | 138
- Configuration | 139
- Verification | 144

This example describes how to configure the routing group to translate per VRF group network traffic to global IP pool.

Requirements

- Understand how SRX Series Firewalls work in an SD-WAN deployment for NAT.
- Understand Virtual Routing and Forwarding Instances. See "[Virtual Routing and Forwarding Instances in SD-WAN Deployments](#)" on page 109.

Overview

In Figure 7, an SRX Series Firewall is configured with routing group to permit VRF group network traffic from MPLS to global IP pool. The SRX Series Firewall is configured with two VRF groups, vpn-A and vpn-B.

Figure 17: Traffic Permit from MPLS to Public Network

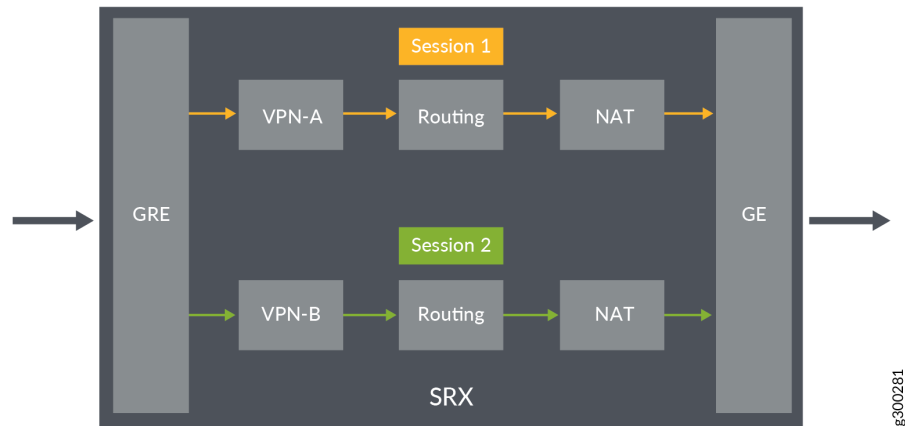

Configuration

IN THIS SECTION

- Procedure | 139
- Results | 142

Procedure

CLI Quick Configuration

To quickly configure this example, copy the following commands, paste them into a text file, remove any line breaks, change any details necessary to match your network configuration, copy and paste the commands into the CLI at the [edit] hierarchy level, and then enter `commit` from configuration mode.

```
set security l3vpn vrf-group vpn-A vrf VRF-A1
set security l3vpn vrf-group vpn-A vrf VRF-A2
set security l3vpn vrf-group vpn-B vrf VRF-B1
set security l3vpn vrf-group vpn-B vrf VRF-B2
set security nat source pool vrf-a_p address 203.0.113.200
set security nat source rule-set vrf-a_rs from routing-group vpn-A
```

```

set security nat source rule-set vrf-a_rs to zone GE_Zone
set security nat source rule-set vrf-a_rs rule rule1 match source-address 192.168.1.200
set security nat source rule-set vrf-a_rs rule rule1 then source-nat pool vrf-a_p
set security nat source pool vrf-b_p address 203.0.113.201
set security nat source rule-set vrf-b_rs from routing-group vpn-B
set security nat source rule-set vrf-b_rs to zone GE_Zone
set security nat source rule-set vrf-b_rs rule rule2 match source-address 192.168.1.201
set security nat source rule-set vpn-b_rs rule rule2 then source-nat pool vrf-b_p
set security policies from-zone GRE_Zone to-zone GE_Zone policy vrf-a_policy match source-
address any
set security policies from-zone GRE_Zone to-zone GE_Zone policy vrf-a_policy match destination-
address any
set security policies from-zone GRE_Zone to-zone GE_Zone policy vrf-a_policy match application
any
set security policies from-zone GRE_Zone to-zone GE_Zone policy vrf-a_policy match source-l3vpn-
vrf-group vpn-A
set security policies from-zone GRE_Zone to-zone GE_Zone policy vrf-a_policy then permit
set security policies from-zone GRE_Zone to-zone GE_Zone policy vrf-b_policy match source-
address any
set security policies from-zone GRE_Zone to-zone GE_Zone policy vrf-b_policy match destination-
address any
set security policies from-zone GRE_Zone to-zone GE_Zone policy vrf-b_policy match application
any
set security policies from-zone GRE_Zone to-zone GE_Zone policy vrf-b_policy match source-l3vpn-
vrf-group vpn-B
set security policies from-zone GRE_Zone to-zone GE_Zone policy vrf-b_policy then permit

```

Step-by-Step Procedure

The following example requires you to navigate various levels in the configuration hierarchy. For instructions on how to do that, see *Using the CLI Editor in Configuration Mode* in the [CLI User Guide](#).

To configure source NAT mapping for a single VRF:

1. In Layer 3 VPNs create a VRF group vpn-A with VRF instances A1 and A2.

```

[edit security]
user@host#set l3vpn vrf-group vpn-A vrf VRF-A1
user@host#set l3vpn vrf-group vpn-A vrf VRF-A2

```

2. Create another VRF group vpn-B with VRF instances B1 and B2.

```
[edit security]
user@host# set l3vpn vrf-group vpn-B vrf VRF-B1
user@host# set l3vpn vrf-group vpn-B vrf VRF-B2
```

3. Specify a source NAT IP address pool.

```
[edit security nat source]
user@host# set pool vrf-a_p address 192.168.1.200
user@host# set pool vrf-b_p address 192.168.1.201
```

4. Create a source NAT rule set.

```
[edit security nat source]
user@host# set rule-set rs from routing-group vpn-A
user@host# set rule-set rs from routing-group vpn-B
user@host# set rule-set rs to zone GE_Zone
```

5. Configure a rule that matches packets and translates per VRF group network traffic to global IP pool.

```
[edit security nat source]
user@host# set rule-set rs rule vrf-a_r match destination-address 203.0.113.200
user@host# set rule-set rs rule vrf-a_r then destination-nat pool vrf-a_p
user@host# set rule-set rs rule vrf-b_r match destination-address 203.0.113.201
user@host# set rule-set rs rule vrf-b_r then destination-nat pool vrf-b_p
```

6. Create a security policy to permit vpn-A traffic.

```
[edit security policies from-zone GRE_Zone to-zone GE_Zone]
user@host# set policy vrf-a_policy match source-address any
user@host# set policy vrf-a_policy match destination-address any
user@host# set policy vrf-a_policy match application any
user@host# set policy vrf-a_policy match destination-l3vpn-vrf-group vpn-A
user@host# set policy vrf-a_policy then permit
```

7. Create a security policy to permit vpn-B traffic.

```
[edit security policies from-zone GRE_Zone to-zone GE_Zone]
user@host# set policy vrf-b_policy match source-address any
user@host# set policy vrf-b_policy match destination-address any
user@host# set policy vrf-b_policy match application any
user@host# set policy vrf-b_policy match destination-l3vpn-vrf-group vpn-B
user@host# set policy vrf-b_policy then permit
```

Results

From configuration mode, confirm your configuration by entering the `show security nat` and `show security policies` commands. If the output does not display the intended configuration, repeat the configuration instructions in this example to correct it.

```
[edit]
user@host# show security nat
  source {
    pool vrf-a_p {
      address {
        203.0.113.200/32;
      }
    }
    pool vrf-b_p {
      address {
        203.0.113.201/32;
      }
    }
  }
  rule-set vrf-a_rs {
    from routing-group vpn-A;
    to zone GE_Zone1;
    rule rule1 {
      match {
        source-address 192.168.1.200/32;
      }
      then {
        source-nat {
          pool {
            vrf-a_p;
          }
        }
      }
    }
  }
```

```

    }
  }
  rule-set vrf-b_rs {
    from routing-group vpn-B;
    to zone GE_Zone;
    match {
      source-address 192.168.1.201/32;
    }
    then {
      source-nat {
        pool {
          vrf-b_p;
        }
      }
    }
  }
}
}
}
}

```

```

[edit]
user@host# show security policies
from-zone GRE_Zone to-zone GE_Zone {
  policy vrf-a_policy {
    match {
      source-address any;
      destination-address any;
      application any;
      destination-l3vpn-vrf-group vpn-A;
    }
    then {
      permit;
    }
  }
  policy vrf-b_policy {
    match {
      source-address any;
      destination-address any;
      application any;
      destination-l3vpn-vrf-group vpn-B;
    }
    then {

```

```

        permit;
    }
}
}

```

If you are done configuring the device, enter `commit` from configuration mode.

Verification

IN THIS SECTION

- [Verifying Destination NAT Rule Usage and Security Policies | 144](#)

Verifying Destination NAT Rule Usage and Security Policies

Purpose

Verify that there is traffic matching the source NAT rule.

Action

From operational mode, enter the `show security nat source rule all` command. In the Translation hits field, verify whether there is traffic that matches the source NAT rule.

```

user@host> show security nat source rule all
Total source-nat rules: 2
Total referenced IPv4/IPv6 ip-prefixes: 2/0
Source NAT rule                : vrf-a_r
Rule-set: rs
Rule-Id                        : 1
Rule position                  : 1
From routing-group            : vpn-A To zone                : GE_Zone1
Source addresses                : 203.0.113.200 - 203.0.113.200
Action                         : vrf-a_p
Translation hits               : 0
  Successful sessions          : 0
  Failed sessions              : 0
Number of sessions             : 0

```



```

Source NAT rule                               : vrf-b_r
Rule-set: rs
  Rule-Id                                     : 2
  Rule position                               : 2
  From routing-group                         : vpn-A
  To zone                                     : GE_Zone
  Destination addresses                      : 203.0.113.201 - 203.0.113.201
  Action                                      : vrf-b_p
  Translation hits                           : 0
    Successful sessions                      : 0
    Failed sessions                         : 0
  Number of sessions                        : 0

```

From operational mode, enter the `show security policies` command to display a summary of all the security policies configured on the device.

```

user@root> show security policies
Default policy: permit-all
From zone: GRE_Zone, To zone: GE_Zone
  Policy: vrf-a_policy, State: enabled, Index: 4, Scope Policy: 0, Sequence number: 1
    Source L3VPN VRF Group: any
    destination L3VPN VRF Group: vpn-A
    Source addresses: any
    Destination addresses: any
    Applications: any
    Action: permit
From zone: GRE_Zone, To zone: GE_Zone
  Policy: vrf-b_policy, State: enabled, Index: 5, Scope Policy: 0, Sequence number: 2
    Source L3VPN VRF Group: any
    destination L3VPN VRF Group: vpn-B
    Source addresses: any
    Destination addresses: any
    Applications: any
    Action: permit

```

Example: Configuring a Security Policy to Permit VRF-Based Traffic from MPLS Network to MPLS Network without NAT using VRF Group

IN THIS SECTION

- Requirements | 146
- Overview | 147
- Configuration | 147
- Verification | 150

This example describes how to configure the routing group to permit traffic between MPLS networks without using NAT.

Figure 18: Traffic between MPLS Networks

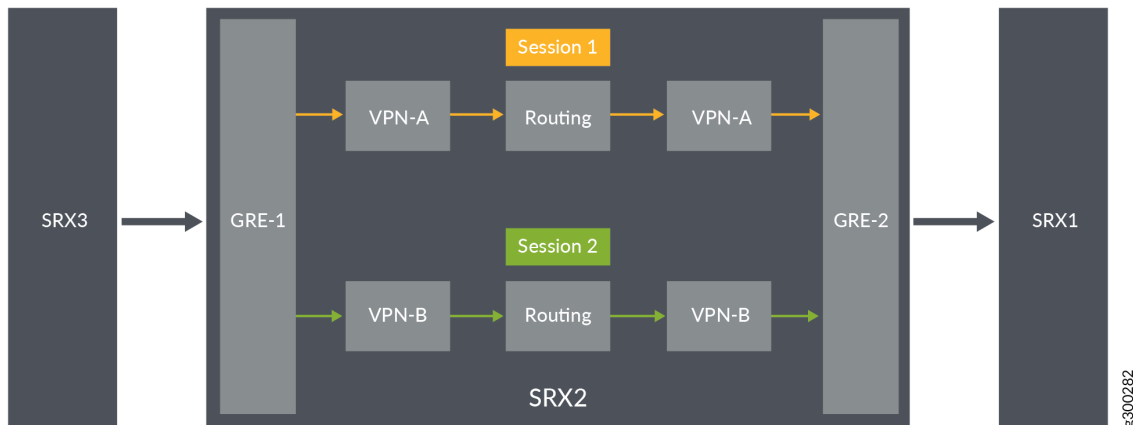

Requirements

- Understand how SRX Series Firewalls work in an SD-WAN deployment for NAT.
- Understand Virtual Routing and Forwarding Instances. See "[Virtual Routing and Forwarding Instances in SD-WAN Deployments](#)" on page 109.

Overview

In [Figure 18 on page 146](#), an SRX Series Firewall is configured with routing group to permit traffic between MPLS networks without using NAT. The SRX Series Firewall is configured with two VRF groups, vpn-A and vpn-B.

Configuration

IN THIS SECTION

- [Procedure | 147](#)
- [Results | 149](#)

Procedure

CLI Quick Configuration

To quickly configure this example, copy the following commands, paste them into a text file, remove any line breaks, change any details necessary to match your network configuration, copy and paste the commands into the CLI at the [edit] hierarchy level, and then enter `commit` from configuration mode.

```

set security l3vpn vrf-group vpn-A vrf VRF-A1
set security l3vpn vrf-group vpn-A vrf VRF-A2
set security l3vpn vrf-group vpn-A1 vrf VRF-A11
set security l3vpn vrf-group vpn-A1 vrf VRF-A12
set security l3vpn vrf-group vpn-B vrf VRF-B1
set security l3vpn vrf-group vpn-B vrf VRF-B2
set security l3vpn vrf-group vpn-B1 vrf VRF-B11
set security l3vpn vrf-group vpn-B1 vrf VRF-B12
set security policies from-zone GRE-1_Zone to-zone GRE-2_Zone policy vrf-a_policy match source-
address any
set security policies from-zone GRE-1_Zone to-zone GRE-2_Zone policy vrf-a_policy match
destination-address any
set security policies from-zone GRE-1_Zone to-zone GRE-2_Zone policy vrf-a_policy match
application any
set security policies from-zone GRE-1_Zone to-zone GRE-2_Zone policy vrf-a_policy match source-
l3vpn-vrf-group vpn-A1
set security policies from-zone GRE-1_Zone to-zone GRE-2_Zone policy vrf-a_policy then permit

```

```

set security policies from-zone GRE-1_Zone to-zone GRE-2_Zone policy vrf-b_policy match source-
address any
set security policies from-zone GRE-1_Zone to-zone GRE-2_Zone policy vrf-b_policy match
destination-address any
set security policies from-zone GRE-1_Zone to-zone GRE-2_Zone policy vrf-b_policy match
application any
set security policies from-zone GRE-1_Zone to-zone GRE-2_Zone policy vrf-b_policy match source-
l3vpn-vrf-group vpn-B1
set security policies from-zone GRE-1_Zone to-zone GRE-2_Zone policy vrf-b_policy then permit

```

Step-by-Step Procedure

The following example requires you to navigate various levels in the configuration hierarchy. For information about navigating the CLI, see *Using the CLI Editor in Configuration Mode* in the [CLI User Guide](#).

To configure source NAT mapping for a single VRF:

1. In Layer 3 VPNs create a VRF group vpn-A with VRF instances A1 and A2.

```

[edit security]
user@host#set l3vpn vrf-group vpn-A vrf VRF-A1
user@host#set l3vpn vrf-group vpn-A vrf VRF-A2

```

2. In Layer 3 VPNs create a VRF group vpn-A1 with VRF instances A11 and A12.

```

[edit security]
user@host#set l3vpn vrf-group vpn-A1 vrf VRF-A11
user@host#set l3vpn vrf-group vpn-A1 vrf VRF-A12

```

3. Create another VRF group vpn-B with VRF instances B1 and B2.

```

[edit security]
user@host#set l3vpn vrf-group vpn-B vrf VRF-B1
user@host#set l3vpn vrf-group vpn-B vrf VRF-B2

```

4. Create another VRF group vpn-B1 with VRF instances B11 and B12.

```
[edit security]
user@host# set l3vpn vrf-group vpn-B1 vrf VRF-B11
user@host# set l3vpn vrf-group vpn-B1 vrf VRF-B12
```

5. Create a security policy to permit vpn-A1 traffic.

```
[edit security policies from-zone GRE-1_Zone to-zone GRE-2_Zone]
user@host# set policy vrf-a_policy match source-address any
user@host# set policy vrf-a_policy match destination-address any
user@host# set policy vrf-a_policy match application any
user@host# set policy vrf-a_policy match destination-l3vpn-vrf-group vpn-A1
user@host# set policy vrf-a_policy then permit
```

6. Create a security policy to permit vpn-B1 traffic.

```
[edit security policies from-zone GRE-1_Zone to-zone GRE-2_Zone]
user@host# set policy vrf-b_policy match source-address any
user@host# set policy vrf-b_policy match destination-address any
user@host# set policy vrf-b_policy match application any
user@host# set policy vrf-b_policy match destination-l3vpn-vrf-group vpn-B1
user@host# set policy vrf-b_policy then permit
```

Results

From configuration mode, confirm your configuration by entering the `show security policies` command. If the output does not display the intended configuration, repeat the configuration instructions in this example to correct it.

```
[edit]
user@host# show security policies
from-zone GRE-1_Zone to-zone GRE-2_Zone {
  policy vrf-a_policy {
    match {
      source-address any;
      destination-address any;
      application any;
      destination-l3vpn-vrf-group vpn-A1;
    }
  }
}
```

```
    }
    then {
        permit;
    }
}
policy vrf-b_policy {
    match {
        source-address any;
        destination-address any;
        application any;
        destination-l3vpn-vrf-group vpn-B1;
    }
    then {
        permit;
    }
}
}
```

If you are done configuring the device, enter `commit` from configuration mode.

Verification

IN THIS SECTION

- [Verifying Security Policies | 150](#)

Verifying Security Policies

Purpose

Verify that configuration output of security policies.

Action

From operational mode, enter the `show security policies` command to display a summary of all the security policies configured on the device.

```
user@root> show security policies
Default policy: permit-all
From zone: GRE-1_Zone, To zone: GRE-2_Zone
  Policy: vrf-a_policy, State: enabled, Index: 4, Scope Policy: 0, Sequence number: 1
    Source L3VPN VRF Group: any
    destination L3VPN VRF-Group: vpn-A1
    Source addresses: any
    Destination addresses: any
    Applications: any
    Action: permit
From zone: GRE-1_Zone, To zone: GRE-2_Zone
  Policy: vrf-b_policy, State: enabled, Index: 5, Scope Policy: 0, Sequence number: 2
    Source L3VPN VRF Group: any
    destination L3VPN VRF-Group: vpn-B1
    Source addresses: any
    Destination addresses: any
    Applications: any
    Action: permit
```

Example: Configuring a Security Policy to Permit VRF-Based Traffic from MPLS Network to MPLS Network using NAT and VRF Group

IN THIS SECTION

- [Requirements | 152](#)
- [Overview | 152](#)
- [Configuration | 152](#)
- [Verification | 158](#)

This example describes how to configure the routing group and permit traffic between MPLS networks using NAT.

Figure 19: Traffic Permit between MPLS Networks with NAT

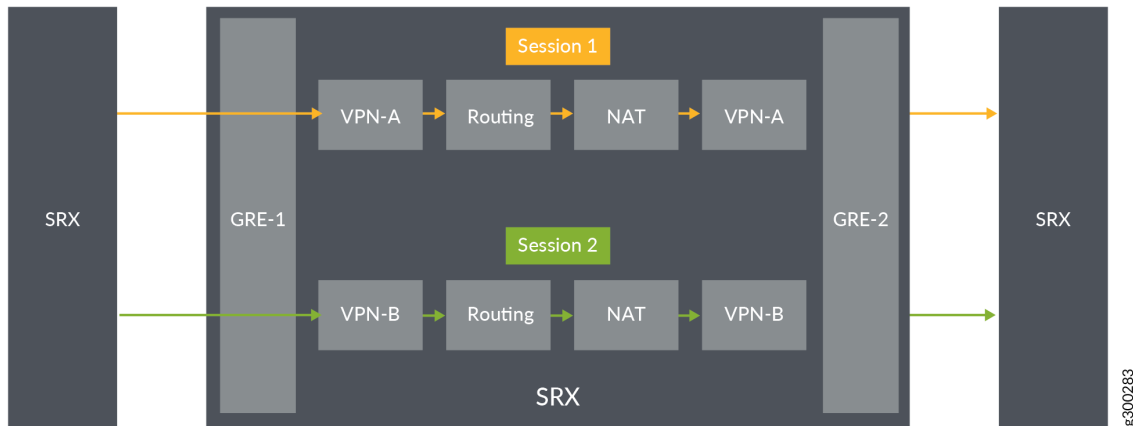

Requirements

- Understand how SRX Series Firewalls work in an SD-WAN deployment for NAT.
- Understand Virtual Routing and Forwarding Instances. See "[Virtual Routing and Forwarding Instances in SD-WAN Deployments](#)" on page 109.

Overview

In [Figure 19 on page 152](#), an SRX Series Firewall is configured the routing group and permit traffic between MPLS networks using NAT. The SRX Series Firewall is configured with the VRF groups, vpn-A, vpn-A1, vpn-B, and vpn-B1.

Configuration

IN THIS SECTION

- Procedure | [153](#)
- Results | [156](#)

Procedure

CLI Quick Configuration

To quickly configure this example, copy the following commands, paste them into a text file, remove any line breaks, change any details necessary to match your network configuration, copy and paste the commands into the CLI at the [edit] hierarchy level, and then enter `commit` from configuration mode.

```

set security l3vpn vrf-group vpn-A vrf VRF-A1
set security l3vpn vrf-group vpn-A vrf VRF-A2
set security l3vpn vrf-group vpn-A1 vrf VRF-A11
set security l3vpn vrf-group vpn-A1 vrf VRF-A12
set security l3vpn vrf-group vpn-B vrf VRF-B1
set security l3vpn vrf-group vpn-B vrf VRF-B2
set security l3vpn vrf-group vpn-B1 vrf VRF-B11
set security l3vpn vrf-group vpn-B1 vrf VRF-B12
set security nat source pool vrf-a_p address 203.0.113.200
set security nat source rule-set vrf-a_rs from routing-group vpn-A
set security nat source rule-set vrf-a_rs to routing-group vpn-A1
set security nat source rule-set vrf-a_rs rule rule1 match source-address 192.168.1.200
set security nat source rule-set vrf-a_rs rule rule1 then source-nat pool vrf-a_p
set security nat source pool vrf-b_p address 203.0.113.201
set security nat source rule-set vrf-b_rs from routing-group vpn-B
set security nat source rule-set vrf-b_rs to routing-group vpn-B1
set security nat source rule-set vrf-b_rs rule rule2 match source-address 192.168.1.201
set security nat source rule-set vrf-b_rs rule rule2 then source-nat pool vrf-b_p
set security policies from-zone GRE-1_Zone to-zone GRE-2_Zone policy vrf-a_policy match source-
address any
set security policies from-zone GRE-1_Zone to-zone GRE-2_Zone policy vrf-a_policy match
destination-address any
set security policies from-zone GRE-1_Zone to-zone GRE-2_Zone policy vrf-a_policy match
application any
set security policies from-zone GRE-1_Zone to-zone GRE-2_Zone policy vrf-a_policy match source-
l3vpn-vrf-group vpn-A1
set security policies from-zone GRE-1_Zone to-zone GRE-2_Zone policy vrf-a_policy then permit
set security policies from-zone GRE-1_Zone to-zone GRE-2_Zone policy vrf-b_policy match source-
address any
set security policies from-zone GRE-1_Zone to-zone GRE-2_Zone policy vrf-b_policy match
destination-address any
set security policies from-zone GRE-1_Zone to-zone GRE-2_Zone policy vrf-b_policy match
application any
set security policies from-zone GRE-1_Zone to-zone GRE-2_Zone policy vrf-b_policy match source-

```

```

13vpn-vrf-group vpn-B1
set security policies from-zone GRE-1_Zone to-zone GRE-2_Zone policy vrf-b_policy then permit

```

Step-by-Step Procedure

The following example requires you to navigate various levels in the configuration hierarchy. For information about navigating the CLI, see *Using the CLI Editor in Configuration Mode* in the [CLI User Guide](#).

To configure source NAT mapping for a single VRF:

1. In Layer 3 VPNs create a VRF group vpn-A with VRF instances A1 and A2.

```

[edit security]
user@host#set 13vpn vrf-group vpn-A vrf VRF-A1
user@host#set 13vpn vrf-group vpn-A vrf VRF-A2

```

2. In Layer 3 VPNs create a VRF group vpn-A1 with VRF instances A11 and A12.

```

[edit security]
user@host#set 13vpn vrf-group vpn-A1 vrf VRF-A11
user@host#set 13vpn vrf-group vpn-A1 vrf VRF-A12

```

3. Create another VRF group vpn-B with VRF instances B1 and B2.

```

[edit security]
user@host#set 13vpn vrf-group vpn-B vrf VRF-B1
user@host#set 13vpn vrf-group vpn-B vrf VRF-B2

```

4. Create another VRF group vpn-B1 with VRF instances B11 and B12.

```

[edit security]
user@host#set 13vpn vrf-group vpn-B1 vrf VRF-B11
user@host#set 13vpn vrf-group vpn-B1 vrf VRF-B12

```

5. Specify a source NAT IP address pool.

```
[edit security nat source]
user@host# set pool vrf-a_p address 192.168.1.200
user@host# set pool vrf-b_p address 192.168.1.201
```

6. Create a source NAT rule set.

```
[edit security nat source]
user@host# set rule-set rs from routing-group vpn-A
user@host# set rule-set rs from routing-group vpn-B
user@host# set rule-set rs to routing-group vpn-A1
user@host# set rule-set rs to routing-group vpn-B1
```

7. Configure a rule that matches packets and translates per VRF group network traffic to global IP pool.

```
[edit security nat source]
user@host# set rule-set rs rule vrf-a_rs match destination-address 203.0.113.200
user@host# set rule-set rs rule vrf-a_rs then destination-nat pool vrf-a_p
user@host# set rule-set rs rule vrf-b_rs match destination-address 203.0.113.201
user@host# set rule-set rs rule vrf-b_rs then destination-nat pool vrf-b_p
```

8. Create a security policy to permit vpn-A1 traffic.

```
[edit security policies from-zone GRE-1_Zone to-zone GRE-2_Zone]
user@host# set policy vrf-a_policy match source-address any
user@host# set policy vrf-a_policy match destination-address any
user@host# set policy vrf-a_policy match application any
user@host# set policy vrf-a_policy match destination-l3vpn-vrf-group vpn-A1
user@host# set policy vrf-a_policy then permit
```

9. Create a security policy to permit vpn-B1 traffic.

```
[edit security policies from-zone GRE-1_Zone to-zone GRE-2_Zone]
user@host# set policy vrf-b_policy match source-address any
user@host# set policy vrf-b_policy match destination-address any
user@host# set policy vrf-b_policy match application any
```

```
user@host# set policy vrf-b_policy match destination-l3vpn-vrf-group vpn-B1
user@host# set policy vrf-b_policy then permit
```

Results

From configuration mode, confirm your configuration by entering the `show security nat` and `show security policies` commands. If the output does not display the intended configuration, repeat the configuration instructions in this example to correct it.

```
[edit]
user@host# show security nat
source {
  pool vrf-a_p {
    address {
      203.0.113.200/32;
    }
  }
  pool vrf-b_p {
    address {
      203.0.113.201/32;
    }
  }
  rule-set vrf-a_rs {
    from routing-group vpn-A;
    to routing-group vpn-A1;
    rule rule1 {
      match {
        source-address 192.168.1.200/32;
      }
      then {
        source-nat {
          pool {
            vrf-a_p;
          }
        }
      }
    }
  }
  rule-set vrf-b_rs {
    from routing-group vpn-B;
    to routing-group vpn-B1;
    match {
```

Verification

IN THIS SECTION

- [Verifying Security Policies | 158](#)

Verifying Security Policies

Purpose

Verify that there is traffic matching the source NAT rule.

Action

From operational mode, enter the `show security nat source rule all` command. In the Translation hits field, verify whether there is traffic that matches the destination NAT rule.

```

user@host> show security nat source rule all
Total source-nat rules: 2
Total referenced IPv4/IPv6 ip-prefixes: 2/0
Source NAT rule           : vrf-a_r
Rule-set                   : rs
  Rule-Id                   : 1
  Rule position              : 1
  From routing-group        : vpn-A
  To zone                    : GE_Zone1
  Source addresses           : 203.0.113.200 - 203.0.113.200
  Action                     : vrf-a_p
  Translation hits           : 0
    Successful sessions      : 0
    Failed sessions         : 0
  Number of sessions        : 0
Source NAT rule           : vrf-b_r
Rule-set                   : rs
  Rule-Id                   : 2
  Rule position              : 2
  From routing-group        : vpn-A
  To zone                    : GE_Zone

```

```

Destination addresses      : 203.0.113.201 - 203.0.113.201
Action                    : vrf-b_p
Translation hits          : 0
  Successful sessions      : 0
  Failed sessions         : 0
Number of sessions        : 0

```

From operational mode, enter the `show security policies` command to display a summary of all the security policies configured on the device.

```

user@root> show security policies
Default policy: permit-all
From zone: GRE-1_Zone, To zone: GRE-2_Zone
  Policy: vrf-a_policy, State: enabled, Index: 4, Scope Policy: 0, Sequence number: 1
    Source L3VPN VRF Group: any
    destination L3VPN VRF Group: vpn-A1
    Source addresses: any
    Destination addresses: any
    Applications: any
    Action: permit
From zone: GRE-1_Zone, To zone: GRE-2_Zone
  Policy: vrf-b_policy, State: enabled, Index: 5, Scope Policy: 0, Sequence number: 2
    Source L3VPN VRF Group: any
    destination L3VPN VRF Group: vpn-B1
    Source addresses: any
    Destination addresses: any
    Applications: any
    Action: permit

```

Multicast Support in SD-WAN Deployments

Starting in Junos OS Release 21.2R1, we've added support for multicast traffic on SRX Series Firewalls in Provider Edge (PE) for SD-WAN deployments. The support for multicast traffic is available when the security device is operating with forwarding option set as flow-based in the `set security forwarding-options family mpls mode hierarchy`. See [forwarding-options \(Security\)](#).

Limitations

- Support for multicast traffic not available when the device is operating with forwarding option set as packet-based.
- Support for multicast traffic available for only hub-and-spoke topology with IP-over-MPLS-over-GRE and IP-over-MPLS-over-GRE-over-IPsec

- Support for multicast traffic does not introduce any changes or address any limitations related to multicast VPN (MVPN) data forwarding functionality. See [Limiting Routes to Be Advertised by an MVPN VRF Instance](#).

RELATED DOCUMENTATION

NAT for VRF Routing Instance

Understanding ALG Support for VRF Routing Instance

Configuring Security Policies for a VRF Routing Instance

3

CHAPTER

Flow-Based Processing for IPv6

[IPv6 Flow-Based Processing](#) | 162

[Understanding Path MTU Messages for IPv6 Packets](#) | 177

[IPv6 Flow-Based Processing Overview](#) | 179

IPv6 Flow-Based Processing

IN THIS SECTION

- [IPv6 Advanced Flow | 162](#)
- [Understanding IPv6 Flow Processing on SRX5400, SRX5600, and SRX5800 devices | 164](#)
- [Enabling Flow-Based Processing for IPv6 Traffic | 167](#)
- [Flow-Based Processing for IPv6 Traffic on Security Devices | 169](#)
- [Using Filters to Display IPv6 Session and Flow Information for SRX Series Services Gateways | 171](#)

This topic covers information on flow processing for IPv6 traffic and IPv6 sessions.

IPv6 Advanced Flow

IN THIS SECTION

- [Understanding Sessions for IPv6 Flow | 164](#)

IPv6 advanced flow adds IPv6 support for firewall, NAT, NAT-PT, multicast (local link and transit), IPsec, IDP, JSF framework, TCP Proxy, and Session manager on SRX Series Firewalls. MIBs are not used in the IPv6 flow.

In order to avoid the impact on the current IPv4 environment, IPv6 security is used. If IPv6 security is enabled, extended sessions and gates are allocated. The existing address fields and gates are used to store the index of extended sessions or gates. If IPv6 security is disabled, IPv6 security-related resources are not allocated.

New logs are used for IPv6 flow traffic to prevent impact on performance in the existing IPv4 system.

The behavior and implementation of the IPv6 advanced flow are the same as those of IPv4 in most cases.

The implementations of sessions, gates, ip-actions, processing of multithread, distribution, locking, synchronization, serialization, ordering, packet queuing, asynchronous messaging, IKE traffic issues, sanity check, and queues for IPv6 are similar to IPv4 implementations.

Some of the differences are explained below:

- **Header Parse** IPv6 advanced flow stops parsing the headers and interprets the packet as the corresponding protocol packet if it encounters the following extension headers:

- TCP/UDP
- ESP/AH
- ICMPv6

IPv6 advanced flow continues parsing headers if it encounters the following extension headers:

- Hop-by-Hop
- Routing and Destination, Fragment

IPv6 advanced flow interprets the packets as an unknown protocol packet if it encounters the extension header **No Next Header**

- **Sanity Checks**— IPv6 advanced flow supports the following sanity checks:
 - TCP length
 - UDP length
 - Hop-by-hop
 - IP data length error
 - Layer 3 sanity checks (for example, IP version and IP length)
 - **ICMPv6 Packets** In IPv6 advanced flow, the ICMPv6 packets share the same behavior as normal IPv6 traffic with the following exceptions:
 - Embedded ICMPv6 packet
 - Path MTU message
- **Host Inbound and Outbound Traffic** IPv6 advanced flow supports all route and management protocols running on the Routing Engine (RE), including OSPF v3, RIPng, Telnet, and SSH. Note that no flow label is used in the flow.
- **Tunnel Traffic** IPv6 advanced flow supports the following tunnel types:
 - IPv4 IP-IP

- IPv4 GRE
- IPv4 IPsec
- Dual-stack lite
- **Events and Logs** The following logs are for IPv6-related flow traffic:
 - RT_FLOW_IPVX_SESSION_DENY
 - RT_FLOW_IPVX_SESSION_CREATE
 - RT_FLOW_IPVX_SESSION_CLOSE

Understanding Sessions for IPv6 Flow

This topic gives an overview of flow-based sessions.

Most packet processing occurs in the context of a flow, including management of policies, zones, and most screens. A session is created for the first packet of a flow for the following purposes:

- To store most of the security measures to be applied to the packets of the flow.
- To cache information about the state of the flow. For example, logging and counting information for a flow is cached in its session. (Also, some stateful firewall screens rely on threshold values that pertain to individual sessions or across all sessions.)
- To allocate resources required for features for the flow.
- To provide a framework for features such as Application Layer Gateways (ALGs).

Understanding IPv6 Flow Processing on SRX5400, SRX5600, and SRX5800 devices

This topic introduces the architecture for the SRX5400, SRX5600, and SRX5800 devices. Flow processing on these devices is similar to that on branch SRX Series Firewalls.

These devices include I/O cards (IOCs) and Services Processing Cards (SPCs) that each contain processing units that process a packet as it traverses the device. These processing units have different responsibilities.

- A Network Processing Unit (NPU) runs on an IOC. An IOC has one or more NPUs. An NPU processes packets discretely and performs basic flow management functions.

When an IPv6 packet arrives at an IOC, the packet flow process begins.

- The NPU performs the following IPv6 sanity checks for the packet:
 - For the IPv6 basic header, it performs the following header checks:
 - Version. It verifies that the header specifies IPv6 for the version.
 - Payload length. It checks the payload length to ensure that the combined length of the IPv6 packet and the Layer 2 header is shorter than the Layer 2 frame length.
 - Hop limit. It checks to ensure that the hop limit does not specify 0 (zero).
 - Address checks. It checks to ensure that the source IP address does not specify ::0 or FF::00 and that the destination IP address does not specify ::0 or ::1.
 - The NPU performs IPv6 extension header checks, including the following:
 - Hop-by-hop options. It verifies that this is the first extension header to follow the IPv6 basic header.
 - Routing extension. It verifies that there is only one routing extension header.
 - Destination options. It verifies that no more than two destination options extension headers are included.
 - Fragment. It verifies that there is only one fragment header.

NOTE: The NPU treats any other extension header as a Layer 4 header.

- The NPU performs Layer 4 TCP, UDP, and ICMP6 protocol checks, including the following:
 - UDP. It checks to ensure that IP Payload Length packets, other than a first-fragment packet, are at least 8 bytes long.
 - TCP. It checks to ensure that IP Payload Length packets, other than a first-fragment packet, are at least 20 bytes long.
 - ICMPv6. It checks to ensure that IP Payload Length packets, other than a first-fragment packet, are at least 8 bytes long.
- If the packet specifies a TCP or a UDP protocol, the NPU creates a tuple from the packet header data using the following information:
 - Source IP address
 - Destination IP address
 - Source port

- Destination port
- Protocol
- Virtual router identifier (VRID)

The device looks up the VRID from a VRID table.

- For Internet Control Message Protocol version 6 (ICMPv6) packets, the tuple contains the same information as used for the TCP and the UDP search key, except for the source and destination port fields. The source and destination port fields are replaced with the following information extracted from the ICMPv6 packet:
 - For ICMP error packets: The pattern "0x00010001"
 - For ICMP information packets: The type, or code, field identifier
- For packets with an Authentication Header (AH) or an Encapsulating Security Payload (ESP) header, the search key is the same as that used for the TCP and the UDP tuple, except for the source and destination port fields. In this case, the security parameter index (SPI) field value is used instead of the source and destination ports. For Encapsulating Security Payload (ESP) header and Authentication Header (AH), before enhancements to the central point architecture it is hashed by the 3-tuple and the security parameter index (SPI) field, after enhancements to the central point architecture it is hashed by an IP pair.
- If a session exists for the packet's flow, the NPU sends the packet to the SPU that manages the session.
- If a matching session does not exist,
 - The NPU sends the packet information to the central point, which creates a pending session.
 - The central point selects an SPU to process the packet and create sessions for it.
 - The SPU then sends session creation messages to the central point and the ingress and egress NPUs, directing them to create a session for the packet flow.
- A central point, which can run on a dedicated SPU, or share the resources of one if there is only one SPU. A central point takes care of arbitration and allocation of resources, and it distributes sessions in an intelligent way. The central point assigns an SPU to be used for a particular session when the SPU processes the first packet of its flow.
- For SRX5000 line devices, the central point architecture is divided into two modules—the application central point and the distributed central point (DCP). The App-CP is responsible for global resource management and loading balancing, while DCP is responsible for traffic identification (global session matching). The App-CP functionality runs on the dedicated central point SPU, while the DCP functionality is distributed to the rest of the SPUs.

- One or more SPUs that run on a Services Processing Card (SPC). All flow-based services for a packet are executed on a single SPU, within the context of a session that is set up for the packet flow.

The SPC for SRX5000 line devices has two SPUs.

Several SPCs can be installed in a chassis.

Primarily, an SPU performs the following tasks:

- It manages the session and applies security features and other services to the packet.
- It applies packet-based stateless firewall filters, classifiers, and traffic shapers.
- If a session does not already exist for a packet, the SPU sends a request message to the NPU that performed the search for the packet's session, to direct it to add a session for it.

These discrete, cooperating parts of the system store the information identifying whether a session exists for a stream of packets and the information against which a packet is matched to determine if it belongs to an existing session.

Enabling Flow-Based Processing for IPv6 Traffic

You have the following options for handling IPv6 traffic:

- Drop—Do not forward IPv6 packets.
- Packet-based forwarding—Do not create a session and process according to packet-based features only (includes firewall filters and class of service).
- Flow-based forwarding—Create a session and process according to packet-based features (including firewall filters and class of service) but also flow-based security features, such as screens and firewall security policy. This is the default behavior.

To enable flow-based processing for IPv6 traffic, modify the `mode` statement at the `[edit security forwarding-options family inet6]` hierarchy level:

```
security {
  forwarding-options {
    family {
      inet6 {
        mode flow-based;
      }
    }
  }
}
```

```

    }
}

```

The following example shows the CLI commands you use to configure forwarding for IPv6 traffic:

```

[edit]
user@host# set security forwarding-options family inet6 mode ?
Possible completions:
  drop          Disable forwarding
  flow-based    Enable flow-based forwarding
  packet-based  Enable packet-based forwarding

[edit]
user@host# set security forwarding-options family inet6 mode flow-based
user@host# show security forwarding-options
family {
  inet6 {
    mode flow-based;
  }
}

```

If you change the forwarding option mode for IPv6, you might need to perform a reboot to initialize the configuration change. [Table 8 on page 168](#) summarizes device status upon configuration change.

Table 8: Device Status Upon Configuration Change

Configuration Change	Commit Warning	Reboot Required	Impact on Existing Traffic Before Reboot	Impact on New Traffic Before Reboot
Drop to flow-based	Yes	Yes	Dropped	Dropped
Drop to packet-based	No	No	Packet-based	Packet-based
Flow-based to packet-based	Yes	Yes	None	Flow sessions created
Flow-based to drop	Yes	Yes	None	Flow sessions created
Packet-based to flow-based	Yes	Yes	Packet-based	Packet-based

Table 8: Device Status Upon Configuration Change (Continued)

Configuration Change	Commit Warning	Reboot Required	Impact on Existing Traffic Before Reboot	Impact on New Traffic Before Reboot
Packet-based to drop	No	No	Dropped	Dropped

Flow-Based Processing for IPv6 Traffic on Security Devices

Flow-based processing mode is required for security features such as zones, screens, and firewall policies to function. By default, the SRX Series Firewall is enabled for flow-based forwarding for IPv6 traffic on all devices, apart from the SRX300 Series and SRX550M devices that are set to drop mode. Starting with Junos OS Release 15.1X49-D70 and Junos OS Release 17.3R1, for the SRX1500 series, SRX4100, SRX4200, SRX5400, SRX5600, SRX5800 and vSRX Virtual Firewall devices, you do *not* need to reboot the device when you are switching modes between flow mode, packet mode, and drop mode. For SRX300 Series and SRX550M devices, you *must* reboot the device when switching between flow mode, packet mode, and drop mode.

SRX300 Series and the SRX550M Devices

When IPv6 is configured on SRX300 Series and the SRX550M devices, the default behavior is set to drop mode because of memory constraints. In this case, you must reboot the device after changing the processing mode from the drop mode default to flow-based processing mode or packet-based processing mode—that is, between modes on these devices.

NOTE: For drop mode processing, the traffic is dropped directly, it is not forwarded. It differs from packet-mode processing for which the traffic is handled but no security processes are applied.

To process IPv6 traffic on SRX300 Series and the SRX550M devices, you need to configure IPv6 addresses for the transit interfaces that receive and forward the traffic. For information about the inet6 protocol family and procedures for configuring IPv6 addresses for interfaces.

Configuring an SRX Series Device as a Border Router

When an SRX Series Firewall of any type is enabled for flow-based processing or drop mode, to configure the device as a border router you must change the mode to packet-based processing for MPLS. In this case, to configure the SRX Series Firewall to packet mode for MPLS, use the `set security forwarding-options family mpls mode packet-based` statement.

NOTE: As mentioned, for SRX300 Series and the SRX550M devices, whenever you change processing modes, you must reboot the device.

Enabling Flow-Based Processing for IPv6 Traffic on SRX300 Series and SRX550M Devices

To enable flow-based forwarding for IPv6 traffic on SRX300 Series and the SRX550M devices, modify the mode at the [edit security forwarding-options family inet6] hierarchy level:

```
security {
  forwarding-options {
    family {
      inet6 {
        mode flow-based;
      }
    }
  }
}
```

To configure forwarding for IPv6 traffic on SRX300 Series or an SRX500M device:

1. Change the forwarding option mode for IPv6 to flow-based.

```
[edit]
user@host# security forwarding-options family inet6 mode flow-based
```

2. Review your configuration.

```
[edit]
user@host# show security forwarding-options
  family {
    inet6 {
      mode flow-based;
    }
  }
```

3. Commit the configuration.

```
[edit]  
user@host# commit
```

4. Reboot the device.

NOTE: For SRX300 Series and SRX500M devices, the device discards IPv6 type 0 Routing Header (RH0) packets.

Using Filters to Display IPv6 Session and Flow Information for SRX Series Services Gateways

IN THIS SECTION

- [Purpose | 171](#)
- [Action | 172](#)

Purpose

You can display flow and session information about one or more sessions with the `show security flow session` command. IPv6 sessions are included in aggregated statistics.

You can use the following filters with the `show security flow session` command: `application`, `destination-port`, `destination-prefix`, `family`, `idp`, `interface`, `nat`, `protocol`, `resource-manager`, `session-identifier`, `source-port`, `source-prefix`, and `tunnel`.

NOTE: Except for the `session-identifier` filter, the output of all the other filters can be viewed in brief, summary, and extensive mode. Brief mode is the default mode. The output of the `session-identifier` filter can be viewed only in the brief mode.

You can use the same filter options with the `clear security flow session` command to terminate sessions.

Action

The following examples show how to use IPv6-related filters to display summaries and details for IPv6 sessions.

NOTE: Starting in Junos OS Release 15.1X49-D30 and Junos OS Release 17.3R1, many of these session summaries include CP session IDs.

Filtered summary report based on family

```
root> show security flow session summary family ?
Possible completions:
  inet          Show IPv4 sessions
  inet6        Show IPv6/IPv6-NATPT sessions

root> show security flow session summary family inet6
Flow Sessions on FPC10 PIC1:

Valid sessions: 2
Pending sessions: 0
Invalidated sessions: 0
Sessions in other states: 0
Total sessions: 2

Flow Sessions on FPC10 PIC2:

Valid sessions: 1
Pending sessions: 0
Invalidated sessions: 0
Sessions in other states: 0
Total sessions: 1

Flow Sessions on FPC10 PIC3:

Valid sessions: 0
Pending sessions: 0
Invalidated sessions: 1
Sessions in other states: 0
Total sessions: 1
```

Filtered detailed report based on family

```

root> show security flow session family ?
Possible completions:
  inet          Show IPv4 sessions
  inet6         Show IPv6/IPv6-NATPT sessions

root> show security flow session family inet6
Flow Sessions on FPC10 PIC1:
Total sessions: 0

Flow Sessions on FPC10 PIC2:
Total sessions: 0

Flow Sessions on FPC10 PIC3:

Session ID: 430000026, Policy name: default-policy-00/2, Timeout: 1794, Valid
  In: 2001:db8::10/64712 -> 2001:db8::4/21;tcp If: ge-7/1/0.0, Pkts: 8, Bytes: 562, CP Session
ID: 430000025
  Out: 2001:db8::4/21 --> 2001:db8::10/64712;tcp, If: ge-7/1/1.0, Pkts: 12, Bytes: 1014, CP
Session ID: 430000025
Total sessions: 1

```

Filtered brief report based on family

```

root> show security flow session family inet brief
Flow Sessions on FPC10 PIC1:

Session ID: 410000031, Policy name: default-policy-00/2, Timeout: 48, Valid
  In: 203.0.113.8/3 --> 198.51.100.11/43053;icmp, If: ge-7/1/0.0, Pkts: 1, Bytes: 84, CP Session
ID: 410000039
  Out: 198.51.100.11/43053 --> 203.0.113.8/3;icmp, If: ge-7/1/1.0, Pkts: 0, Bytes: 0, CP Session
ID: 410000039
Total sessions: 1

Flow Sessions on FPC10 PIC2:

Session ID: 420000034, Policy name: default-policy-00/2, Timeout: 48, Valid
  In: 203.0.113.8/4 --> 198.51.100.11/43053;icmp, If: ge-7/1/0.0, Pkts: 1, Bytes: 84, CP Session
ID: 420000041
  Out: 198.51.100.11/43053 --> 203.0.113.8/4;icmp, If: ge-7/1/1.0, Pkts: 0, Bytes: 0, CP

```

Session ID: 420000041

Total sessions: 1

Flow Sessions on FPC10 PIC3:

Session ID: 430000042, Policy name: default-policy-00/2, Timeout: 44, Valid

In: 203.0.113.8/2 --> 198.51.100.11/43053;icmp, If: ge-7/1/0.0, Pkts: 1, Bytes: 84, CP Session ID: 430000041

Out: 198.51.100.11/43053 --> 203.0.113.8/2;icmp, If: ge-7/1/1.0, Pkts: 0, Bytes: 0, CP Session ID: 430000041

Total sessions: 1

2001:dbf8::6:2/32

Filtered detailed report based on an IPv6 source-prefix

root> show security flow session source-prefix 2001:dbf8::

Flow Sessions on FPC10 PIC1:

Session ID: 410000066, Policy name: default-policy-00/2, Timeout: 2, Valid

In: 2001:dbf8::6:2/3 > 2001:dbf8:5::2/7214;icmp6, If: ge-7/1/0.0, Pkts: 1, Bytes: 104, CP Session ID: 410000076

Out: 2001:dbf8:5::2/7214 --> 2001:dbf8:5::2/323;icmp6, If: .local..0, Pkts: 1, Bytes: 104, CP Session ID: 410000076

Session ID: 410000068, Policy name: default-policy-00/2, Timeout: 2, Valid

In: 2001:dbf8::6:2/4 --> 2001:dbf8:5::2/7214;icmp6, If: ge-7/1/0.0, Pkts: 1, Bytes: 104, CP Session ID: 410000077

Out: 2001:dbf8:5::2/7214 --> 2001:dbf8::6:2/4;icmp6, If: .local..0, Pkts: 1, Bytes: 104, CP Session ID: 410000077

Total sessions: 2

Flow Sessions on FPC10 PIC2:

Session ID: 420000067, Policy name: default-policy-00/2, Timeout: 28, Valid

In: 2001:dbf8::6:2/4 --> 2001:dbf8:5::3/6702;icmp6, If: ge-7/1/0.0, Pkts: 1, Bytes: 104, CP Session ID: 420000080

Out: 2001:dbf8:5::3/6702 --> 2001:dbf8::6:2/4 ;icmp6, If: ge-7/1/1.0, Pkts: 0, Bytes: 0, CP Session ID: 420000080

Total sessions: 1

Flow Sessions on FPC10 PIC3:

```

Session ID: 430000077, Policy name: default-policy-00/2, Timeout: 28, Valid
  In: 2001:dbf8::6:2/3 --> 2001:dbf8:5::3/6702;icmp6, If: ge-7/1/0.0, Pkts: 1, Bytes: 104, CP
Session ID: 430000075
  Out: 2001:dbf8:5::3/6702 --> 2001:dbf8::6:2/3;icmp6, If: ge-7/1/1.0, Pkts: 0, Bytes: 0, CP
Session ID: 430000075

Session ID: 430000078, Policy name: default-policy-00/2, Timeout: 30, Valid
  In: 2001:dbf8::6:2/5 --> 2001:dbf8:5::3/6702, If: ge-7/1/0.0, Pkts: 1, Bytes: 104, CP Session
ID: 430000076
  Out: 2001:dbf8:5::3/6702 --> 2001:dbf8::6:2/5;icmp6, If: ge-7/1/1.0, Pkts: 0, Bytes: 0, CP
Session ID: 430000076

Session ID: 430000079, Policy name: default-policy-00/2, Timeout: 2, Valid
  In: 2001:dbf8::6:2/5 --> 2001:dbf8:5::1/7214;icmp6, If: ge-7/1/0.0, Pkts: 1, Bytes: 104, CP
Session ID: 430000077
  Out: 2001:dbf8:5::1/7214 --> 2001:dbf8::6:2/5;icmp6, If: .local..0, Pkts: 1, Bytes: 104, CP
Session ID: 430000077
Total sessions: 3

```

Multiple-filtered detailed report based on family, protocol and source-prefix

```

root> show security flow session family inet protocol icmp source-prefix 2001:db8::
Flow Sessions on FPC10 PIC1:

Session ID: 410000074, Policy name: default-policy-00/2, Timeout: 2, Valid
  In: 2001:dbf8::6:2/1 --> 2001:dbf8:8::2/26935;icmp, If: ge-7/1/0.0, Pkts: 1, Bytes: 84, CP
Session ID: 410000195
  Out: 2001:dbf8:8::2 --> 2001:dbf8::6:2/1;icmp, If: ge-7/1/1.0, Pkts: 1, Bytes: 84, CP Session
ID: 410000195
Total sessions: 1

Flow Sessions on FPC10 PIC2:

Session ID: 420000075, Policy name: default-policy-00/2, Timeout: 2, Valid
  In: 2001:dbf8::6:2/3 --> 2001:dbf8::6:2/26935;icmp, If: ge-7/1/0.0, Pkts: 1, Bytes: 84, CP
Session ID: 420000159
  Out: 2001:dbf8::6:2/26935 --> 2001:dbf8::6:2/3;icmp, If: ge-7/1/1.0, Pkts: 1, Bytes: 84, CP
Session ID: 420000159
Total sessions: 1

```

Flow Sessions on FPC10 PIC3:

```

Session ID: 430000085, Policy name: default-policy-00/2, Timeout: 2, Valid
  In: 2001:dbf8::6:2/4 --> 2001:dbf8::6:2/26935;icmp, If: ge-7/1/0.0, Pkts: 1, Bytes: 84, CP
Session ID: 430000083
  Out: 2001:dbf8::6:2/26935 --> 2001:dbf8::6:2/4;icmp, If: ge-7/1/1.0, Pkts: 1, Bytes: 84, CP
Session ID: 430000083
Total sessions: 1

```

Clearing all sessions, including IPv6 sessions

```

root> clear security flow session all
This command may terminate the current session too.
Continue? [yes,no] (no) yes

0 active sessions cleared
1 active sessions cleared
1 active sessions cleared
1 active sessions cleared

```

Clearing only IPv6 sessions

```

root> clear security flow session family ?
Possible completions:
  inet          Clear IPv4 sessions
  inet6         Clear IPv6/IPv6-NATPT sessions

root> clear security flow session family inet6
0 active sessions cleared
1 active sessions cleared
1 active sessions cleared
1 active sessions cleared

```

Release History Table

Release	Description
15.1X49-D70	By default, the SRX Series Firewall is enabled for flow-based forwarding for IPv6 traffic on all devices, apart from the SRX300 Series and SRX550M devices that are set to drop mode. Starting with Junos OS Release 15.1X49-D70 and Junos OS Release 17.3R1, for the SRX1500 series, SRX4100, SRX4200, SRX5400, SRX5600, SRX5800 and vSRX Virtual Firewall devices, you do <i>not</i> need to reboot the device when you are switching modes between flow mode, packet mode, and drop mode. For SRX300 Series and SRX550M devices, you <i>must</i> reboot the device when switching between flow mode, packet mode, and drop mode.
15.1X49-D30	Starting in Junos OS Release 15.1X49-D30 and Junos OS Release 17.3R1, many of these session summaries include CP session IDs.

RELATED DOCUMENTATION

| [IPv6 Flow-Based Processing Overview](#) | 179

Understanding Path MTU Messages for IPv6 Packets

This topic describes path maximum transmission unit (MTU) and explains how the flow module for SRX Series Firewalls processes and uses path MTU messages.

Every link has an MTU size that specifies the size of the largest packet the link can transmit. A larger MTU size means that fewer packets are required to transmit a certain amount of data. To achieve the best data transmission performance, IPv6 data packets sent from one node (the source) to another node (the destination) should be the largest possible size that can traverse the path between the nodes. (Larger and fewer packets constrain the cost of packet header processing and routing processes that can affect transmission performance.)

However, for a packet to successfully traverse the path from the source node to the destination node, the MTU size of the source node interface must be no larger than that of the smallest MTU size of all nodes on the path between the source and destination. This value is referred to as the path maximum transmission unit (path MTU). If a packet is larger than a link's MTU size, it is likely that the link will drop it. For IPv6, an intermediate node cannot fragment a packet.

IPv6 defines a standard mechanism called path MTU discovery that a source node can use to learn the path MTU of a path that a packet is likely to traverse. If any of the packets sent on that path are too large to be forwarded by a node along the path, that node discards the packet and returns an ICMPv6 Packet Too Big message. The source node can then adjust the MTU size to be smaller than that of the node that dropped it and sent the ICMPv6 message, and then retransmit the packet. A source node might receive Packet Too Big messages repeatedly until its packet traverses all nodes along the path successfully.

NOTE: On all SRX Series Firewalls, the Routing Engine cannot detect the path MTU of an IPv6 multicast address (with a large size packet).

After the path MTU size is determined and the appropriate MTU size is set, an outgoing packet might be routed along a different path with a node whose link MTU size is smaller than the path MTU size determined previously. In this case, the flow module engages the path MTU discovery process again.

When the flow module receives an ICMP Packet Too Big message with a destination address that belongs to it, it:

- If the packet is a transit one, the flow module searches for a session that matches the packet's embedded 5-tuple data. If it finds a matching session, it delivers the packet to it. If there is no matching session, it drops the packet.

When the flow module receives a packet, before it transmits it to the egress interface, it checks to determine if the MTU size of the egress interface is greater than the packet length.

- If the MTU size is greater than the packet length, it continues to process the packet.
- If the MTU size is less than the packet length, it drops the packet and sends an ICMPv6 Packet Too Big message to the source node.

NOTE: When *chassis cluster* is configured and the path MTU updates the MTU of the tunnel interface, the flow module does not synchronize the new MTU to peer nodes. The MTU size might be updated again by a larger packet on a peer node, which has no impact on packet transmission.

IPv6 Flow-Based Processing Overview

IN THIS SECTION

- [The IPv6 Packet Header and SRX Series Overview | 179](#)
- [Understanding IPv6 Packet Header Extensions | 180](#)
- [Understanding How SRX Series Firewalls Handle ICMPv6 Packets | 182](#)

Learn about how SRX Series Firewalls process IPv6 packets, IPv6 extension headers, and ICMPv6 packets.

The IPv6 Packet Header and SRX Series Overview

Every IPv6 packet has a minimum 40 bytes (320 bits) long basic packet header. The IPv6 packet header optionally have extension headers, which contains the supplementary information about the network devices.

For IPv6 packets, flow processing parses the extension headers and transport layer headers in the following way:

- If the software encounters a TCP, a UDP, an ESP, an AH, or an ICMPv6 header, it parses the header and assumes that the packet payload corresponds to the specified protocol type.
- If the software encounters a hop-by-hop header, a routing and destination header, or a fragment header, it continues to parse the next extension header.
- If it encounters the no-next-header extension header, the software detects that the packet is that of an unknown protocol (protocol equals 0).
- For other extension headers, the software parses the header and identifies the packet as belonging to the protocol indicated by the extension header.

Understanding IPv6 Packet Header Extensions

IPv6 extension headers contains supplementary information used by network devices (such as routers, switches, and endpoint hosts) to decide how to direct or process an IPv6 packet. The length of each extension header is an integer multiple of 8 octets. This allows subsequent extension headers to use 8-octet structures.

Any header followed by an extension header contains a Next Header value that identifies the extension header type. Extension headers may be placed between the IPv6 header and the upper-layer header in a packet. [Figure 20 on page 180](#) shows an IPv6 packet with the hop-by-hop options header. Similarly, an IPv6 header can carry zero, one, or more extension headers, each identified by the Next Header field of the preceding header. Extension headers always follow the basic IPv6 header in the order as shown in [Table 9 on page 180](#):

Figure 20: IPv6 Extension Header

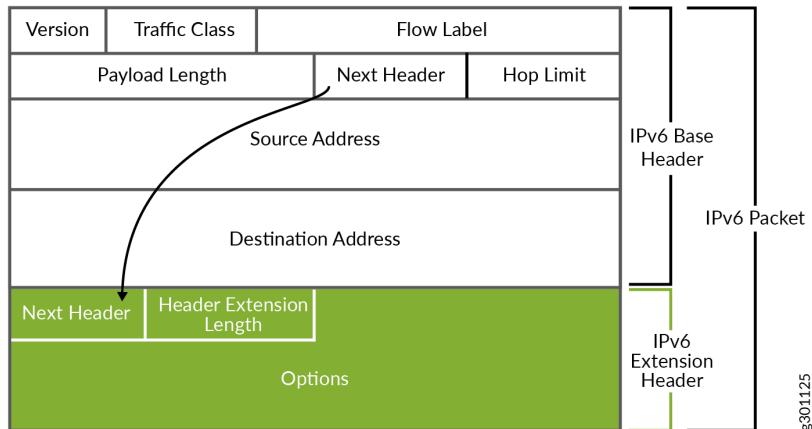

Table 9: IPv6 Extension Headers

Header Name	Purpose	Next Header Value
Hop-by-Hop Options	<p>Specifies delivery parameters at each hop on the path to the destination host.</p> <p>A hop-by-hop option can appear only following the IPv6 basic header. If it is used, it should be the first extension header. It cannot appear after another extension header.</p>	0

Table 9: IPv6 Extension Headers *(Continued)*

Header Name	Purpose	Next Header Value
Destination Options	Specifies packet delivery parameters for either intermediate destination devices or the final destination host. When a packet uses this header.	60
Routing	Defines strict source routing and loose source routing for the packet. (With strict source routing, each intermediate destination device must be a single hop away. With loose source routing, intermediate destination devices can be one or more hops away)	43
Fragment	Specifies how to perform IPv6 fragmentation and reassembly services. A source node uses the fragment extension header to tell the destination node the size of the packet that was fragmented so that the destination node can reassemble the packet.	44
Authentication	Provides authentication, data integrity, and anti-replay protection.	51
Encapsulating Security Payload	Provides data confidentiality, data authentication, and anti-replay protection for Encapsulated Security Payload (ESP) packets.	50
Destination IP Address	Identifies the host device, or interface on a node, to which the IPv6 packet is to be sent. The destination address may appear twice, the first instance after the hop limit following the source IP address and the second instance after the final extension header.	60

For information on IPv6, refer to [RFC2460](#).

SEE ALSO

| *IPv6 Overview*

Understanding How SRX Series Firewalls Handle ICMPv6 Packets

This topic explains Internet Control Message Protocol (ICMP), ICMP messages, and how Junos OS for SRX Series Firewalls uses them.

ICMP provides a framework for reporting packet processing errors, for diagnostic purposes, and for implementation-specific functions. ICMP error messages make it possible for one node to inform another node that something has gone wrong during the course of data transfer. When IP version 6 (IPv6) was defined, the differences between IP version 4 (IPv4) and it were significant enough to require a new version of ICMP.

Every ICMPv6 message is preceded by an IPv6 header and zero or more IPv6 extension headers. The ICMPv6 header is identified by a Next Header value of 58 in the immediately preceding header. This is different from the value used to identify ICMP for IPv4. All ICMPv6 error messages have 32 bits of type-specific data to help the packet recipient locate the embedded invoking packet.

Most ICMPv6 packets have the same characteristics and behavior as normal IPv6 packets, and the Junos OS flow module processes them through first path and fast-path processing in the same way that it does normal IPv6 packets. [Table 10 on page 183](#) shows the ICMPv6 embedded packet types that the flow module handles differently from normal ICMPv6 packets.

For these packets, the flow module uses a tuple that it creates from the embedded ICMPv6 packet to search for a matching session. It continues to process the packet without modifying the maximum transmission unit (MTU) until it finds a matching session, unless it receives an ICMPv6 Packet Too Big message for the interface. In this case, it modifies the MTU size for that interface. If the flow module does not find a matching session or if it cannot obtain a valid IPv6 header from the embedded payload, it drops the packet.

NOTE: A Packet Too Big message is the only kind of ICMPv6 packet that will cause the flow module to modify an interface.

Table 10: ICMPv6 Packets That Junos OS Handles Differently from Other ICMPv6 Packets

Message	Meaning
01-Destination Unreachable	<p>When a packet cannot be delivered because of a problem with the way it is being sent, it is useful to have a feedback mechanism that can tell the source about the problem, including the reason why delivery of the packet failed. For IPv6, the Destination Unreachable message serves this purpose.</p> <p>Each message includes a code that indicates the nature of the problem that caused the packet delivery to fail. It also includes all or part of the packet that could not be delivered, to help the source device resolve the problem.</p> <p>When the flow module encounters a Destination Unreachable ICMP packet whose embedded packet header data matches the 5-tuple data for a session, the software terminates the session.</p>
02-Packet Too Big	<p>When the flow module receives an ICMPv6 Packet Too Big message intended for it, the flow module sends the packet to the ICMP protocol stack on the Routing Engine to engage the path maximum transmission unit (path MTU) discovery process.</p> <p>If the Packet Too Big message does not pertain to the device but rather is a transit packet, the device attempts to match the embedded 5-tuple data with a session.</p> <ul style="list-style-type: none"> • If a matching session exists, the device delivers it to the source node. • If a matching session does not exist, the device drops the packet <p>NOTE: A Packet Too Big message is the only kind of ICMPv6 packet that will cause the flow module to modify an interface.</p>

Table 10: ICMPv6 Packets That Junos OS Handles Differently from Other ICMPv6 Packets (Continued)

Message	Meaning
03-Time Exceeded	When the flow module receives a packet that cannot be delivered because it has exceeded the hop count specified in the basic header hop-by-hop field, it sends this message to inform the packet's source node that the packet was discarded for this reason.
04-Parameter Problem	When the device finds a problem with a field in the IPv6 header or extension headers that makes it impossible for it to process the packet, the software discards it and sends this ICMPv6 message to the packet's source node, indicating the type and location of the problem.

4

CHAPTER

Monitoring Flow-Based Sessions and Establishing Parameters for Error Handling

Monitoring Security Flow Sessions | 186

Monitoring X2 Traffic | 203

Monitoring Security Flow Sessions

IN THIS SECTION

- [Monitoring Security Flow Sessions Overview | 186](#)
- [Understanding How to Obtain Session Information for SRX Series Firewalls | 187](#)
- [Displaying Global Session Parameters for All SRX Series Services Gateways | 189](#)
- [Displaying a Summary of Sessions for SRX Series Services Gateways | 190](#)
- [Displaying Session and Flow Information About Sessions for SRX Series Services Gateways | 190](#)
- [Displaying Session and Flow Information About a Specific Session for SRX Series Services Gateways | 191](#)
- [Using Filters to Display Session and Flow Information for SRX Series Services Gateways | 192](#)
- [Information Provided in Session Log Entries for SRX Series Services Gateways | 193](#)
- [Error Handling Extensions | 199](#)

This topic covers information for monitoring, displaying and verifying of flow sessions using operational mode commands. Thus, you can debug without having to commit or modify your running configuration.

Monitoring Security Flow Sessions Overview

Junos OS allows you to configure and start the monitoring of flow sessions using operational mode commands. Thus, you can debug without having to commit or modify your running configuration. This approach can be especially useful when you do not want to change the state of your device by committing the configuration to turn on trace options.

To configure flow session monitoring, you must define flow filters, specify the output file, and start monitoring. Flow session monitoring does not start unless a filter (at least one) and an output file are specified. Also, defining the filters themselves does not trigger monitoring. You have to explicitly use the `monitor security flow start` and `monitor security flow stop` commands to enable and disable monitoring, respectively.

- Define flow filters—Define the flow sessions that you want to monitor using combinations of match criteria, such as source address, destination address, source port, destination port, IP protocol number, name of the incoming or outgoing interface, and the logical system name. You can delete filters using the `clear monitor security flow filter` command.

NOTE: Unlike filters defined in the configuration mode, filters defined using operational mode commands are cleared when you reboot your system.

- Specify the output file—Create an output file in which the security flow monitoring information is to be saved. This file is saved in the `/var/log/` directory. You can view the contents of this file by using the `show log filename` command. Use the `monitor security flow file` command to specify output file characteristics, such as its maximum size, maximum number, and type.
- Start monitoring—Use the `monitor security flow start` command to start monitoring. Once monitoring starts, any traffic that matches the filters is saved in the specified output file in the `/var/log/` directory. The `basic-datapath` flag is the default flag and turns on as monitoring starts.

Use the `monitor security flow stop` command to stop monitoring. Once monitoring stops, the `basic-datapath` flag is cleared.

- Display monitoring flow information—Use the `show monitoring security flow` command to display details about the monitoring operation.

NOTE: You can configure flow session monitoring and debugging by using the monitoring operational mode commands and flow traceoptions configuration statements. These two operations cannot run in parallel. When you turn on security flow monitoring, the flow traceoption session is blocked and when the flow traceoption session is running, monitoring of the flow session is blocked.

Understanding How to Obtain Session Information for SRX Series Firewalls

You can obtain information about the sessions and packet flows active on your device, including detailed information about specific sessions. (The SRX Series Firewall also displays information about failed sessions.) You can display this information to observe activity and for debugging purposes. For example, you can use the `show security flow session` command:

- To display a list of incoming and outgoing IP flows, including services
- To show the security attributes associated with a flow, for example, the policies that apply to traffic belonging to that flow
- To display the session timeout value, when the session became active, for how long it has been active, and if there is active traffic on the session

NOTE: If an interface NAT is configured and sessions are set up with the NAT using that interface IP address, whenever the interface IP address changes, the sessions set up with NAT get refreshed and new sessions will be setup with new IP address. This you can verify using show security flow session CLI command.

Session information can also be logged if a related policy configuration includes the logging option. For the flow session log on all SRX Series Firewalls, policy configuration has been enhanced. Information on the packet incoming interface parameter in the session log for session-init and session-close and when a session is denied by a policy or by the application firewall is provided to meet Common Criteria (CC) Medium Robustness Protection Profiles (MRPP) compliance:

Policy configuration—To configure the policy for the session for which you want to log matches as log **session-init** or **session-close** and to record sessions in syslog:

- set security policies from-zone untrustZone to-zone trust zone policy policy13 match source-address extHost1
- set security policies from-zone untrustZone to-zone trustZone policy policy13 match application junos-ping
- set security policies from-zone untrustZone to-zone trustZone policy policy13 then permit
- set security policies from-zone untrustZone to-zone trustZone policy policy13 then log session-init
- set security policies from-zone untrustZone to-zone trustZone policy policy13 then log session-close

Example : Flow match policy13 will record the following information in the log:

```
<14>1 2010-09-30T14:55:04.323+08:00 mrpp-srx550-dut01 RT_FLOW -
RT_FLOW_SESSION_CREATE [junos@2626.192.0.2.1.40 source-address="192.0.2.1" source-port="1"
destination-address="198.51.100.12" destination-port="46384" service-name="icmp" nat-source-
address="192.0.2.1" nat-source-port="1" nat-destination-address="198.51.100.12" nat-destination-
port="46384" src-nat-rule-name="None" dst-nat-rule-name="None" protocol-id="1" policy-
name="policy1" source-zone-name="trustZone" destination-zone-name="untrustZone" session-
id-32="41" packet-incoming-interface="ge-0/0/1.0"] session created 192.0.2.1/1--
>198.51.100.12/46384 icmp 192.0.2.1/1-->198.51.100.12/46384 None None 1 policy1 trustZone
untrustZone 41 ge-0/0/1.0
```

```
<14>1 2010-09-30T14:55:07.188+08:00 mrpp-srx550-dut01 RT_FLOW - RT_FLOW_SESSION_CLOSE
[junos@2626.192.0.2.1.40 reason="response received" source-address="192.0.2.1" source-port="1"
destination-address="198.51.100.12" destination-port="46384" service-name="icmp" nat-source-
address="192.0.2.1" nat-source-port="1" nat-destination-address="198.51.100.12" nat-destination-
port="46384" src-nat-rule-name="None" dst-nat-rule-name="None" protocol-id="1" policy-
name="policy1" source-zone-name="trustZone" destination-zone-name="untrustZone" session-
id-32="41" packets-from-client="1" bytes-from-client="84" packets-from-server="1" bytes-from-
```

```
server="84" elapsed-time="0" packet-incoming-interface="ge-0/0/1.0"] session closed response
received: 192.0.2.1/1-->198.51.100.12/46384 icmp 192.0.2.1/1-->198.51.100.12/46384 None None
1 policy1 trustZone untrustZone 41 1(84) 1(84) 0 ge-0/0/1.0
```

Displaying Global Session Parameters for All SRX Series Services Gateways

IN THIS SECTION

- Purpose | 189
- Action | 189
- Meaning | 189

Purpose

Obtain information about configured parameters that apply to all flows or sessions.

Action

To view session information in the CLI, enter the following command:

```
user@host# show security flow
```

Meaning

The `show security flow` configuration command displays the following information:

- `allow-dns-reply`—Identifies if unmatched incoming Domain Name System (DNS) reply packets are allowed.
- `route-change-timeout`—If enabled, displays the session timeout value to be used on a route change to a nonexistent route.
- `tcp-mss`—Shows the current configuration for the TCP maximum segment size value to be used for all TCP packets for network traffic.

- `tcp-session`—Displays all configured parameters that control session parameters.
- `syn-flood-protection-mode`—Displays the SYN Proxy mode.

Displaying a Summary of Sessions for SRX Series Services Gateways

IN THIS SECTION

- [Purpose | 190](#)
- [Action | 190](#)

Purpose

Determine the kinds of sessions on your device, how many of each kind there are—for example, the number of unicast sessions and multicast sessions—the number of failed sessions, the number of sessions that are currently used and the maximum number of sessions that the device supports. This command also displays the details of the sessions that are currently used. For example, valid sessions, pending sessions, invalidated sessions and sessions in other states.

Action

To view session summary information in the CLI, enter the following CLI command:

```
user@host> show security flow session summary
```

Displaying Session and Flow Information About Sessions for SRX Series Services Gateways

IN THIS SECTION

- [Purpose | 191](#)

- [Action | 191](#)

Purpose

Display information about all sessions on your device, including the session ID, the virtual system the session belongs to, the Network Address Translation (NAT) source pool (if source NAT is used), the configured timeout value for the session and its standard timeout, and the session start time and how long the session has been active. The display also shows all standard flow information, including the direction of the flow, the source address and port, the destination address and port, the IP protocol, and the interface used for the session.

Action

To view session flow information in the CLI, enter the following command:

```
user@host> show security flow session
```

Displaying Session and Flow Information About a Specific Session for SRX Series Services Gateways

IN THIS SECTION

- [Purpose | 191](#)
- [Action | 192](#)

Purpose

When you know the session identifier, you can display all session and flow information for a specific session rather than for all sessions.

Action

To view information about a specific session in the CLI, enter the following command:

```
user@host> show security flow session session-identifier 40000381
```

Using Filters to Display Session and Flow Information for SRX Series Services Gateways

IN THIS SECTION

- [Purpose | 192](#)
- [Action | 192](#)

Purpose

You can display flow and session information about one or more sessions by specifying a filter as an argument to the `show security flow session` command. You can use the following filters: `application`, `destination-port`, `destination-prefix`, `family`, `idp`, `interface`, `nat`, `protocol`, `resource-manager`, `session-identifier`, `source-port`, `source-prefix` and `tunnel`. The device displays the information for each session followed by a line specifying the number of sessions reported on. Here is an example of the command using the `source-prefix` filter.

Action

To view information about selected sessions using filters in the CLI, enter the following command:

```
user@host> show security flow session source-prefix 10/8
```

Information Provided in Session Log Entries for SRX Series Services Gateways

Session log entries are tied to policy configuration. Each main session event—create, close, and deny—will create a log entry if the controlling policy has enabled logging.

Different fields are logged for session create, session close, and session deny events as shown in [Table 11 on page 193](#), [Table 12 on page 194](#), and [Table 13 on page 199](#). The same field name under each type indicates that the same information is logged, but each table is a full list of all data recorded for that type of session log.

The following table defines the fields displayed in session log entries.

Table 11: Session Create Log Fields

Field	Description
source-address	Source IP address of the packet that created the session.
source-port	Source port of the packet that created the session.
destination-address	Destination IP address of the packet that created the session.
destination-port	Destination port of the packet that created the session.
service-name	Application that the packet traversed (for example, “junos-telnet” for Telnet traffic during the session allowed by a policy that permits native Telnet).
nat-source-address	The translated NAT source address if NAT was applied; otherwise, the source address as above.
nat-source-port	The translated NAT source port if NAT was applied; otherwise, the source port as above.
nat-destination-address	The translated NAT destination address if NAT was applied; otherwise, the destination address as above.

Table 11: Session Create Log Fields (Continued)

Field	Description
nat-destination-port	The translated NAT destination port if NAT was applied; otherwise, the destination port as above.
src-nat-rule-name	The source NAT rule that was applied to the session (if any). If static NAT is also configured and applied to the session and if source address translation takes place, then this field shows the static NAT rule name.*
dst-nat-rule-name	The destination NAT rule that was applied to the session (if any). If static NAT is also configured and applied to the session and if destination address translation takes place, then this field shows the static NAT rule name.*
protocol-id	The protocol ID of the packet that created the session.
policy-name	The name of the policy that permitted the session creation.
session-id-32	The 32-bit session ID.

* Note that some sessions might have both destination and source NAT applied and the information logged.

Starting with Junos OS Release 12.1X47-D20 and Junos OS Release 17.3R1, the system log includes information about NAT rule type. Two new src-nat-rule-type and dst-nat-rule-type fields are introduced in the NAT rule session.

Table 12: Session Close Log Fields

Field	Description
reason	The reason the session was closed.
source-address	Source IP address of the packet that created the session.
source-port	Source port of the packet that created the session.

Table 12: Session Close Log Fields (Continued)

Field	Description
destination-address	Destination IP address of the packet that created the session.
destination-port	Destination port of the packet that created the session.
service-name	Application that the packet traversed (for example, "junos-telnet" for Telnet traffic during the session allowed by a policy that permits native Telnet).
nat-source-address	The translated NAT source address if NAT was applied; otherwise, the source address as above.
nat-source-port	The translated NAT source port if NAT was applied; otherwise, the source port as above.
nat-destination-address	The translated NAT destination address if NAT was applied; otherwise, the destination address as above.
nat-destination-port	The translated NAT destination port if NAT was applied; otherwise, the destination port as above.
src-nat-rule-name	The source NAT rule that was applied to the session (if any). If static NAT is also configured and applied to the session and if source address translation takes place, then this field shows the static NAT rule name.*
dst-nat-rule-name	The destination NAT rule that was applied to the session (if any). If static NAT is also configured and applied to the session and if destination address translation takes place, then this field shows the static NAT rule name.*
protocol-id	The protocol ID of the packet that created the session.

Table 12: Session Close Log Fields (Continued)

Field	Description
policy-name	The name of the policy that permitted the session creation.
session-id-32	The 32-bit session ID.
packets-from-client	The number of packets sent by the client related to this session.
bytes-from-client	The number of data bytes sent by the client related to this session.
packets-from-server	The number of packets sent by the server related to this session.
bytes-from-server	The number of data bytes sent by the server related to this session.
elapsed-time	The total session elapsed time from permit to close, given in seconds.
unset	<p>During the session creation, you can set the session close reason as unset.</p> <p>The session closes with the reason unset if the session installation on the control point is not successful. The reason for session installation varies, for example, nonavailability of memory for nonmanagement session installation.</p>
TCP CLIENT RST	The session was closed by a TCP reset packet sent to it from the client.
TCP SERVER RST	The session was closed by a TCP reset packet sent to it from the server.

Table 12: Session Close Log Fields (Continued)

Field	Description
TCP FIN	FIN received from either end.
response received	Response received for a packet request (for example, ICMP req-reply).
ICMP error	ICMP error received.
aged out	Session aged out was reached.
ALG	ALG errors closed the session (for example, remote access server (RAS) maximum limit reached).
HA	HA message closed the session.
idle Timeout	There was no traffic for the session before the configured age-out time was reached.
auth	Authentication failed.
IDP	IDP closed the session because of security module (SM) internal error.
synproxy failure	SYN proxy failure closed the session.
synproxy limit	Reason for failure in allocating minor session, need to free original session.
parent closed	Parent session closed.
CLI	Session cleared by a CLI .

Table 12: Session Close Log Fields *(Continued)*

Field	Description
CP NACK	CP NACK response received.
CP delete	CP ACK deletion closed the session.
policy delete	Corresponding policy marked for deletion.
fwd session	Session closed because of forwarding session deletion.
multicast route change	Session closed because multicast route changed.
first path reroute, session recreated	The first path is rerouted and session is re-created.
source NAT allocation failure	SPU received ACK message from the central point but failed to receive the DIP resource. Therefore this packet is dropped and the session is closed.
other	Session closed because of all other reasons (for example, the pim reg tun needed refreshing).
error create IKE pass-through template	IKE pass-through template creation errors.
IKE pass-through child session ageout	Session is deleted because the IKE pass through template session has no child.
sess timeout on pending state	Pending session closed because time out timer reached the pending state.
unknown	Session closed because of unknown reasons.

** Note that some sessions might have both destination and source NAT applied and the information logged.*

Table 13: Session Deny Log Fields

Field	Description
source-address	Source IP address of the packet that attempted to create the session.
source-port	Source port of the packet that attempted to create the session.
destination-address	Destination IP address of the packet that attempted to create the session.
destination-port	Destination port of the packet that attempted to create the session.
service-name	Application that the packet attempted to traverse.
protocol-id	The protocol ID of the packet that attempted to create the session.
icmp-type	The ICMP type if the denied packet was ICMP configured; otherwise, this field will be 0.
policy-name	The name of the policy that denied the session creation.

Error Handling Extensions

IN THIS SECTION

- [Understanding Chassis Manager FPC Fault Detection and Error Handling Enhancements | 200](#)

Understanding Chassis Manager FPC Fault Detection and Error Handling Enhancements

IN THIS SECTION

- Error Handling on IOCs and SPCs | 200
- Error Detection and Management | 200
- Error Detection Processes | 201
- Integration with Chassis Cluster | 202
- Wedge Detection, Reporting, and Management | 202

The Junos OS Routing Engine and microkernel error detection and management feature on the SRX5400, SRX5600, and SRX5800 devices enables the Routing Engine and the ukernel to accumulate and store the history of all reported error activity and counters for various severity levels. You can configure how errors are handled and specify the severity levels and the actions to perform when an error is detected and a threshold is reached. You can generate and display reports for encountered errors based on stored information.

Starting with Junos OS Release 15.1X49-D30 and Junos OS Release 17.3R1, error detection enhancements are provided that detect additional errors on IOCs and SPCs and provide enhanced error management. This implementation extends the error detection and management covered in the `show chassis fpc error` topic.

NOTE: This feature is not supported on Routing Engine version 1.

Error Handling on IOCs and SPCs

Starting with Junos OS Release 15.1-X49-D50 and Junos OS Release 17.3R1, the error management enhancements are supported on IOC2 and IOC3 I/O cards (IOCs) and SPC2 Services Processing Cards (SPCs). Some enhancement functions are particular to either the IOC2 and the IOC3 or the SPC2 FPCs, and the differences are called out in this topic.

Error Detection and Management

Error management entails:

- Detecting an error.

Junos OS monitors the chassis component state to detect a set of error conditions. A detected error can belong to one of the preconfigured error severity levels:

- Fatal
- Major
- Minor
- Identifying the action to take.

When an error occurs, the system identifies the action to take based on the severity level of the error and the thresholds set and met.

An FPC maintains a set of error counters for each error severity level. An error counter set consists of a counter that is cumulative across all errors and counters for individual errors and types. It is this information that is stored in the Routing Engine. Each occurrence counter is associated with an error occurrence threshold. There are two threshold levels: one based on the type and the other on severity.

- Executing the action.

For these enhancements, the preconfigured actions that you can direct the device to take when the Routing Engine's error occurrence count for a given security level reaches the configured threshold are:

- Reset
- Offline
- Alarm
- Get-state
- Log



CAUTION: Take care when setting the fault handling actions for SPC2 cards on the SRX5000 line of devices. Consider that if you set the fault handling action on an SPC2 card to offline or reset, when the card is either taken offline or the reboot occurs, the chassis daemon (chassisd) will reboot all of its FPC cards, both SPCs and IOCs—that is, the entire chassis will be rebooted.

Error Detection Processes

With these enhancements, the following error detection processes are enabled and supported:

- Error management on the Routing Engine version 2.

- Error management on ukernel modules on SPC2 cards.
- Error management on the IOC2 and IOC3 cards.
- Driver checks for datapath error detection of wedge conditions.

NOTE: Wedge condition detection for the Trinity Offload Engine driver is supported only on SPC2 cards. That is, it is not supported on the IOC2 and IOC3 cards.

- Wedge detection for host loopback.

NOTE: Wedge condition detection for host loopback is supported only on SPC2 cards. That is, it is not supported on the IOC2 and IOC3 cards.

- Chassis Manager fabric error detection.
- Control path error detections on IOC2 and IOC3 cards.

Integration with Chassis Cluster

In a chassis cluster environment, when an alarm is raised for the first time because of a major or a fatal error, a Redundancy Group 1 (RG1) switchover is triggered. This is the standard behavior on SRX Series Firewalls, and it remains unchanged. However, with these enhancements, the alarm is added to the default fault handling action list for a fatal error. Adding an alarm to the default fault handling list allows the chassis alarm to trigger the RG1 switchover as soon as the fatal error is detected.

Wedge Detection, Reporting, and Management

A wedge condition is caused by an error that blocks network traffic.

This feature detects several types of wedge conditions. It:

- Determines if the wedge is transient or irreversible.
- Records the wedge conditions in statistics and syslogs.
- Alerts network administrators to irreversible wedges by raising a chassis alarm on the Routing Engine.
- Verifies that the following datapath error detections are enabled for the IOC2, IOC3, and SPC2 cards:
 - Wedge detection for XM driver

- Wedge detection for LU driver
- Wedge detection for XL driver
- Wedge detection for TOE driver (SPC2 only)
- Wedge detection for host loopback (SPC2 only)

All datapath wedge conditions are detected and reported within 5 seconds. Each error detecting module records and reports the state and history of its identifiable wedge conditions.

Release History Table

Release	Description
15.1X49-D50	Starting with Junos OS Release 15.1-X49-D50 and Junos OS Release 17.3R1, the error management enhancements are supported on IOC2 and IOC3 I/O cards (IOCs) and SPC2 Services Processing Cards (SPCs).
15.1X49-D30	Starting with Junos OS Release 15.1X49-D30 and Junos OS Release 17.3R1, error detection enhancements are provided that detect additional errors on IOCs and SPCs and provide enhanced error management.
12.1X47-D20	Starting with Junos OS Release 12.1X47-D20 and Junos OS Release 17.3R1, the system log includes information about NAT rule type.

RELATED DOCUMENTATION

| [Monitoring X2 Traffic | 203](#)

Monitoring X2 Traffic

IN THIS SECTION

- [Understanding X2 Traffic Monitoring | 204](#)
- [Example: Configuring a Mirror Filter for X2 Traffic Monitoring | 208](#)

This topic covers X2 traffic monitoring on SRX Series Firewalls.

Understanding X2 Traffic Monitoring

IN THIS SECTION

- [X2 Traffic Monitoring Overview | 204](#)
- [Limitations of X2 Traffic Monitoring | 206](#)
- [X2 Traffic Terminology | 207](#)

In an LTE mobile network, SRX Series Firewalls act as secure gateways connecting Evolved Node Bs (eNodeBs) for signal handover, monitoring, and radio coverage. SRX Series Firewalls use IPsec tunnels to connect eNodeBs. The user plane and control plane traffic that flows from one eNodeB to the other eNodeB is called the X2 traffic.

X2 Traffic Monitoring Overview

The X2 traffic passing through IPsec tunnels is encrypted. Because of this, mobile network operators need a way to monitor X2 traffic so that they can debug handover issues across eNodeBs. The Junos OS implementation allows monitoring of the X2 traffic by snooping into the cleartext X2 traffic as it flows through the SRX Series Firewall coming out of one IPsec tunnel and going into the other IPsec tunnel—after traffic is decrypted and before it is encrypted again.

[Figure 21 on page 205](#) shows the flow of X2 traffic within the SRX Series Firewall. As the traffic reaches the SRX Series Firewall on one st0.x interface, it gets decrypted. Then it is encrypted and forwarded to the destination eNodeB through its dedicated st0.y interface. Snooping is performed on the decrypted X2 traffic on the SRX Series Firewall.

Figure 21: SRX Series Firewall in an LTE Mobile Network

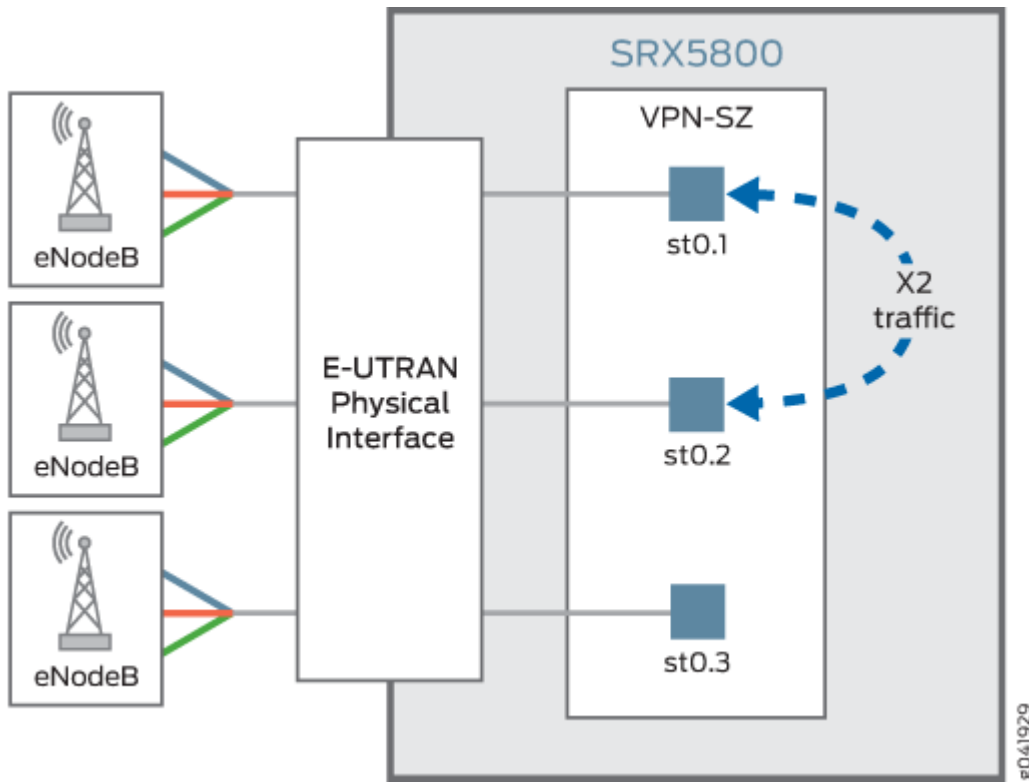
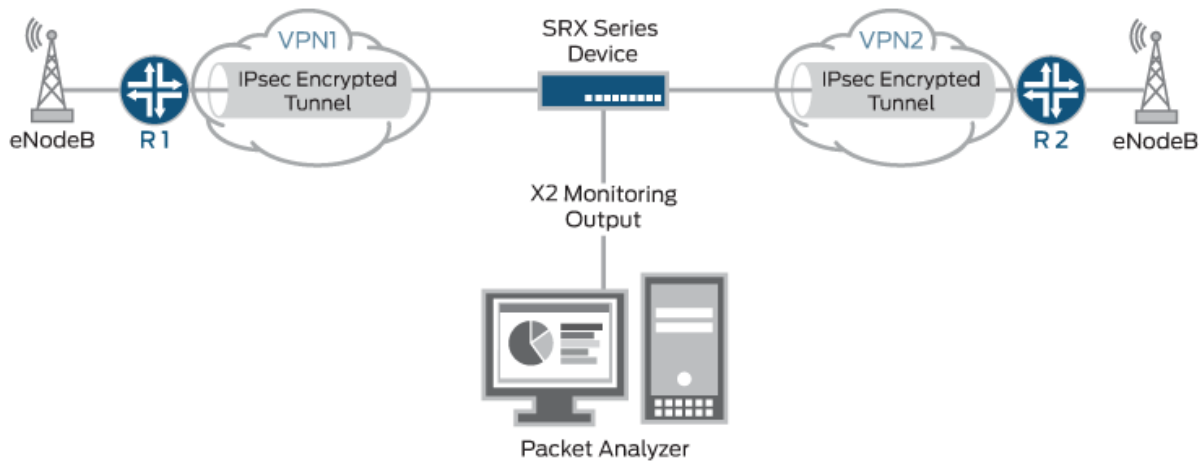

Figure 22 on page 206 shows a mobile operators network with an SRX Series Firewall providing IPsec tunnel connection between the two eNodeBs. The SRX Series Firewall is connected to a packet analyzer (also called a *sniffing* device) that is used for collecting and monitoring the X2 traffic. The IPsec tunnel from each eNodeB terminates on a dedicated secure tunnel interface on the SRX Series Firewall. Inbound traffic coming out of the IPsec tunnel is decrypted while outbound traffic leaving the device is encrypted.

Figure 22: Monitoring X2 Traffic



80041690

To monitor the X2 traffic, you can configure up to 15 different mirror filters that specify unique sets of parameters against which traffic is matched. The filtered packets are duplicated and sent to a physical interface. To allow the packet analyzer to capture the filtered packets, you specify the output interface on the SRX Series Firewall and the MAC address of the packet analyzer. Because the output interface is connected to the same Layer 2 network as the packet analyzer, once mirror filtering is turned on, the packet analyzer can collect and analyze the X2 traffic.

The SRX Series mirror filter feature is bidirectional, much like a session. X2 traffic flowing through an IPsec VPN that matches a mirror filter is mirrored and analyzed; traffic returning from those devices is also mirrored and analyzed.

Starting in Junos OS Release 18.4R1, if the output X2 interface of a mirror filter is configured for an st0 interface to filter traffic that you want to analyze, the packet is duplicated and encrypted by the IPsec tunnel bound to the st0 interface. This enhancement supports the SRX Series Firewalls to send traffic mirrored from a port on an IPsec tunnel. Mirrored traffic includes unmodified Layer 3 headers.

NOTE: Although there is no minimum required number of parameters for a mirror filter, please be mindful that if you specify too few criteria or accidentally commit an incomplete filter, an over-proportional amount of traffic flow through the system could be mirrored.

Limitations of X2 Traffic Monitoring

For X2 traffic in a chassis cluster setup, mirrored packets cannot traverse through the data link (fabric interface).

X2 Traffic Terminology

Table 14 on page 207 lists some X2 traffic related terms and their descriptions.

Table 14: X2 Traffic Terminology

Term	Description
Evolved packet core (EPC)	Main component of System Architecture Evolution (SAE) and is also known as the SAE core. The EPC supports the IP network and serves as the equivalent of a General Packet Radio Service (GPRS) network, using the mobility management entity (MME), Serving Gateway (SGW), and Packet Data Network Gateway (PGW) subcomponents.
Evolved Universal Terrestrial Radio Access Network (E-UTRAN)	A radio access network standard. E-UTRAN is a new air interface system. It provides higher data rates and lower latency and is optimized for packet data. It uses Orthogonal Frequency-Division Multiple Access (OFDMA) for the downlink and Single-carrier Frequency Division Multiple Access for the uplink.
Evolved Node B (eNodeB)	A device connected to the mobile phone network that communicates directly with mobile handsets, like a base transceiver station in Global System for Mobile Communications (GSM) networks. An eNodeB is controlled by a radio network controller (RNC).
Long Term Evolution (LTE)	A standard for wireless communication of high-speed data for mobile phones and data terminals. It increases the capacity and speed using a different radio interface and makes core network improvements.
X2 interface	A point-to-point logical interface between two eNodeBs with the E-UTRAN. It supports the exchange of signaling information between two eNodeBs and supports the forwarding of protocol data units (PDUs) to the respective tunnel endpoints.
X2 Application Protocol (X2AP)	Protocol used by the X2 interface. It is used for handling the user equipment mobility within the E-UTRAN and provides the following functions: <ul style="list-style-type: none"> • Manages mobility and load • Reports general error situations • Sets and resets the X2 interface • Updates the eNodeB configuration

Example: Configuring a Mirror Filter for X2 Traffic Monitoring

IN THIS SECTION

- Requirements | 208
- Overview | 208
- Configuration | 210
- Verification | 212

This example shows how to configure a mirror filter to monitor X2 traffic between two eNodeBs in an LTE mobile network.

Requirements

Before you begin:

- Understand X2 traffic monitoring. .
- Configure the interfaces, security zones, security policies, and the route-based VPN tunnels to allow data to be securely transferred between the SRX Series Firewall and the two eNodeBs.

Overview

As a network operator, you need a way to monitor the X2 traffic to debug any handover issues across eNodeBs. The mirror filter feature allows you to do that. Traffic coming out of an IPsec tunnel is decrypted, mirrored and analyzed, and then encrypted again to go into the outbound IPsec tunnel.

More specifically, traffic that matches a mirror filter is mirrored and sent to an output interface that is connected to a packet analyzer (also called a *sniffing* device). The packet analyzer analyzes the X2 traffic, allowing you to monitor it. Then the traffic is encrypted again before it is sent to the outbound IPsec tunnel.

The SRX Series mirror filter feature is bidirectional, much like a session. X2 traffic flowing through an IPSec VPN that matches a mirror filter is mirrored and analyzed; traffic returning from those devices is also mirrored and analyzed.

To use the mirror filter feature to monitor X2 traffic, you configure mirror filters. You can configure up to 15 different mirror filters to be used concurrently to filter for various kinds of traffic. Each mirror filter contains a set of parameters and their values against which traffic is matched.

NOTE: Although there is no minimum required number of parameters for a mirror filter, please be mindful that if you specify too few criteria or accidentally commit an incomplete filter, an over-proportional amount of traffic flow through the system could be mirrored.

A mirror filter can contain some or all of the following parameters to filter traffic:

- destination IP address prefix
- destination port
- IP protocol
- source IP address prefix
- source port
- incoming and outgoing interfaces

You also specify the output interface and the MAC address of the packet analyzer as part of the configuration.

In this example, an SRX Series Firewall uses IPsec tunnels to connect two eNodeBs in an LTE mobile network. The example configures a mirror filter called traffic-https.

Figure 23 on page 209 shows the SRX Series Firewall connecting to the eNodeBs using IPsec tunnels. The SRX Series Firewall is also connected to a packet analyzer.

Figure 23: Configuring Mirror Filters for X2 Traffic Monitoring

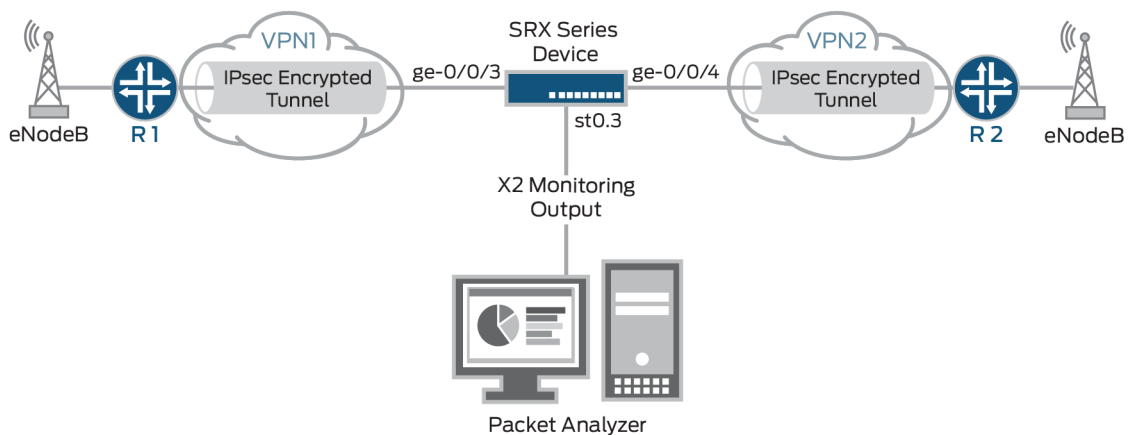

In this example, all HTTPS traffic is analyzed whose destination is to devices with IP addresses that have the prefix 203.0.113.0/24 and for which the destination port 443 is used, the default port for HTTPS traffic. Packets that match the traffic-https filter are *mirrored* and sent through the output interface ge-0/0/5 to the packet analyzer with the MAC address 00:50:56:87:20:5E. Returning traffic from these devices is also monitored.

NOTE: The output interface for mirror filter is that of the packet analyzer, which is why the HTTP protocol is used.

The output interface for the packet analyzer uses the HTTP protocol.

Configuration

IN THIS SECTION

- [Procedure | 210](#)

Procedure

CLI Quick Configuration

To quickly configure this example, copy the following commands, paste them into a text file, remove any line breaks, change any details necessary to match your network configuration, copy and paste the commands into the CLI at the [edit] hierarchy level, and then enter `commit` from configuration mode.

```
set security forwarding-options mirror-filter traffic-https
set security forwarding-options mirror-filter traffic-https destination-port 443
set security forwarding-options mirror-filter traffic-https destination-prefix 203.0.113.0/24
set security forwarding-options mirror-filter traffic-https protocol 6
set security forwarding-options mirror-filter traffic-http output interface ge-0/0/5
set security forwarding-options mirror-filter traffic-http output destination-mac
00:50:56:87:20:5E
```

Step-by-Step Procedure

The following example requires you to navigate various levels in the configuration hierarchy. For instructions on how to do that, see *Using the CLI Editor in Configuration Mode* in the [CLI User Guide](#).

To configure a mirror filter for monitoring X2 traffic:

1. Create a mirror filter called traffic-https.

```
[edit]
user@host# edit security forwarding-options mirror-filter traffic-https
```

2. Specify the mirror filter parameters against which traffic is matched.

```
[edit security forwarding-options mirror-filter traffic-https]
user@host# set destination-port 443
user@host# set destination-prefix 203.0.113.0/24
user@host# set protocol 6
```

3. Specify the output interface for the mirrored packets to be sent to the packet analyzer.

```
[edit security forwarding-options mirror-filter traffic-https]
user@host# set output interface ge-0/0/5
```

4. Specify the MAC address of the packet analyzer as a destination for all mirrored packets, that is, those packets that match the mirror filters.

```
[edit security forwarding-options mirror-filter traffic-https]
user@host# set output destination-mac 00:50:56:87:20:5E
```

Results

From configuration mode, confirm your configuration by entering the `show security forwarding-options` command. If the output does not display the intended configuration, repeat the configuration instructions in this example to correct it.

```
user@host# show security forwarding-options
  mirror-filter traffic-https {
    protocol 6;
    destination-port 443;
    destination-prefix 203.0.113.0/24;
    output {
      interface ge-0/0/5;
```

```
        destination-mac 00:50:56:87:20:5E;  
    }  
}
```

If you are done configuring the device, enter `commit` from configuration mode.

Verification

IN THIS SECTION

- [Verifying the Status of Mirror Filter | 212](#)

Confirm that the configuration is working properly.

Verifying the Status of Mirror Filter

Purpose

Verify that mirror filter is active or not.

Action

From operational mode, enter the `show security forward-options mirror-filter` command for the specific mirror filter.

```
user@host> show security forward-options mirror-filter traffic-https  
Security mirror status  
  
mirror-filter-name: traffic-https  
protocol: 6  
    destination-port: 443  
destination-prefix 203.0.113.0/24  
filter-counters: 2  
output-counters: 2
```

Meaning

The output provides the mirror filter status. It shows that a mirror filter called traffic-https is active. The traffic-https mirror filter specifies the protocol, destination prefix, and destination port that traffic must match in order for it to be mirrored and analyzed.

This output shows that two packets were mirrored.

5

CHAPTER

Packet Based Forwarding

[Packet-Based Forwarding | 215](#)

[Reverse Route Packet Mode using Virtual Router | 249](#)

[Express Path Overview | 252](#)

Packet-Based Forwarding

IN THIS SECTION

- [Understanding Packet-Based Processing | 215](#)
- [Understanding Selective Stateless Packet-Based Services | 216](#)
- [Selective Stateless Packet-Based Services Configuration Overview | 218](#)
- [Example: Configuring Selective Stateless Packet-Based Services for End-to-End Packet-Based Forwarding | 220](#)
- [Example: Configuring Selective Stateless Packet-Based Services for Packet-Based to Flow-Based Forwarding | 235](#)

An SRX Series Firewall operate in two different modes: packet mode and flow mode. In flow mode, SRX processes all traffic by analyzing the state or session of traffic. This is also called stateful processing of traffic. In packet mode, SRX processes the traffic on a per-packet basis. This is also known as stateless processing of traffic.

Understanding Packet-Based Processing

Packets that enter and exit a Juniper Networks device running Junos OS can undergo packet-based processing. Packet-based, or stateless, packet processing treats packets discretely. Each packet is assessed individually for treatment. Stateless packet-based forwarding is performed on a packet-by-packet basis without regard to flow or state information. Each packet is assessed individually for treatment.

[Figure 24 on page 216](#) shows the traffic flow for packet-based forwarding.

Figure 24: Traffic Flow for Packet-Based Forwarding

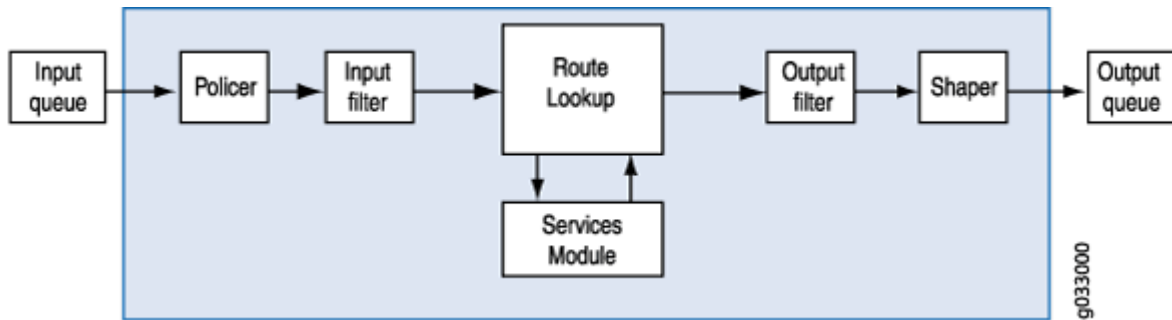

As packets enter the device, classifiers, filters and policers are applied to it. Next, the egress interface for the packet is determined through a route lookup. Once the egress interface for the packet is found, filters are applied and the packet is sent to the egress interface where it is queued and scheduled for transmission.

Packet-based forwarding does not require any information about either previous or subsequent packets that belong to a given connection, and any decision to allow or deny traffic is packet specific. This architecture has the benefit of massive scaling because it forwards packets without keeping track of individual flows or state.

Starting with Junos OS Release 15.1X49-D100, for the SRX100, SRX110, SRX210, SRX220, SRX240, SRX300, SRX320, SRX340, SRX345, SRX550M, and SRX650, the maximum capture size for packet captures is expanded to 1520 bytes to allow for captures of 1500 bytes of data and the 12-byte Juniper Ethernet header."

Understanding Selective Stateless Packet-Based Services

Selective stateless packet-based services allow you to use both flow-based and packet-based forwarding simultaneously on a system. You can selectively direct traffic that requires packet-based, stateless forwarding to avoid stateful flow-based forwarding by using stateless firewall filters, also known as access control lists (ACLs). The traffic not so directed follows the default flow-based forwarding path. Bypassing flow-based forwarding can be useful for traffic for which you explicitly want to avoid flow session-scaling constraints.

By default, Juniper Networks Security devices running Junos OS use flow-based forwarding. Selective stateless packet-based services allows you to configure the device to provide only packet-based processing for selected traffic based on input filter terms. Other traffic is processed for flow-based forwarding. Bypassing flow-based forwarding is useful for deployments where you want to avoid session-scaling constraints and session creation and maintenance costs.

When you configure the device for selective stateless packet-based processing, packets entering the system are treated differently depending on certain conditions:

- If a packet satisfies matching conditions specified in input filter terms, it is marked for packet mode and all configured packet mode features are applied to it. No flow-based security features are applied. It bypasses them.
- If a packet has not been flagged for packet-mode, it undergoes normal processing. All services except for MPLS can be applied to this traffic.

Figure 25 on page 217 shows traffic flow with selective stateless packet-based services bypassing flow-based processing.

Figure 25: Traffic Flow with Selective Stateless Packet-Based Services

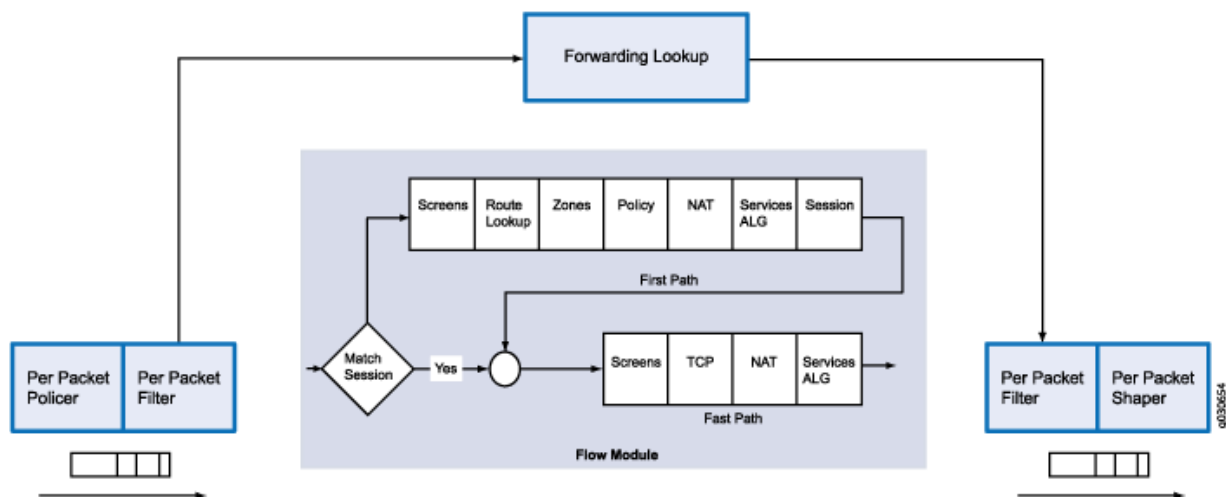

When the packet comes in on an interface, the input packet filters configured on the interface are applied.

- If the packet matches the conditions specified in the *firewall filter*, a packet-mode action modifier is set to the packet. The packet-mode action modifier updates a bit field in the packet key buffer—this bit field is used to determine if the flow-based forwarding needs to be bypassed. As a result, the packet with the packet-mode action modifier bypasses the flow-based forwarding completely. The egress interface for the packet is determined through a route lookup. Once the egress interface for the packet is found, filters are applied and the packet is sent to the egress interface where it is queued and scheduled for transmission.
- If the packet does not match the conditions specified in this filter term, it is evaluated against other terms configured in the filter. If, after all terms are evaluated, a packet matches no terms in a filter, the packet is silently discarded. To prevent packets from being discarded, you configure a term in the filter specifying an action to accept all packets.

A defined set of stateless services is available with selective stateless packet-based services:

- IPv4 routing (unicast and multicast protocols)
- *Class of service* (CoS)
- Link fragmentation and interleaving (LFI)
- Generic routing encapsulation (GRE)
- Layer 2 switching
- Multiprotocol Label Switching (MPLS)
- Stateless firewall filters
- Compressed Real-Time Transport Protocol (CRTP)

Although traffic requiring MPLS services must be processed in packet mode, under some circumstances it might be necessary to concurrently apply certain services to this traffic that can only be provided in flow mode, such as stateful inspection, NAT, and IPsec. To direct the system to process traffic in both flow and packet modes, you must configure multiple routing instances connected through a tunnel interface. One routing instance must be configured to process the packets in flow mode and the other routing instance must be configured to process the packets in packet mode. When you use a tunnel interface to connect routing instances, traffic between those routing instances is injected again into the forwarding path and it can then be reprocessed using a different forwarding method.

Selective Stateless Packet-Based Services Configuration Overview

This feature is supported on SRX300, SRX320, SRX340, SRX345, SRX550M, SRX1500, and vSRX Virtual Firewall devices. You configure selective stateless packet-based services using the stateless firewall filters, also known as access control lists (ACLs). You classify traffic for packet-based forwarding by specifying match conditions in the firewall filters and configure a `packet-mode` action modifier to specify the action. Once match conditions and actions are defined, firewall filters are applied to relevant interfaces.

To configure a firewall filter:

1. Define the address family—First define the address family of the packets that a firewall filter matches. To define the family name, specify `inet` to filter IPv4 packets. Specify `mpls` to filter MPLS packets. Specify `ccc` to filter Layer 2 switching cross-connects.
2. Define terms—Define one or more terms that specify the filtering criteria and the action to take if a match occurs. Each term consists of two components—match conditions and actions.

- Match conditions—Specify certain characteristics that the packet must match for the action to be performed. You can define various match conditions, such as the IP source address field, IP destination address field, and IP protocol field.
- Action—Specify what is to be done with the packet if it matches the match conditions. Possible actions are to accept, discard, or reject a packet; go to the next term; or take no action.

You can specify only one action (or omit it) in a term, but you can specify any combination of action modifiers with it. Action modifiers include a default accept action. For example, if you specify an action modifier and do not specify an action, the specified action modifier is implemented and the packet is accepted.

The `packet-mode` action modifier specifies traffic to bypass flow-based forwarding. Like other action modifiers, you can configure the `packet-mode` action modifier along with other actions, such as `accept` or `count`.

3. Apply firewall filters to interfaces—Apply the firewall filter to the interface to have the firewall filter take effect.

When the packet comes in on an interface, the input packet filters configured on the interface are applied. If the packet matches the specified conditions and `packet-mode` action is configured, the packet bypasses the flow-based forwarding completely.

When configuring filters, be mindful of the order of the terms within the firewall filter. Packets are tested against each term in the order in which it is listed in the configuration. When the first matching conditions are found, the action associated with that term is applied to the packet and the evaluation of the firewall filter ends, unless the `next term` action modifier is included. If the `next term` action is included, the matching packet is then evaluated against the next term in the firewall filter; otherwise, the matching packet is not evaluated against subsequent terms in the firewall filter.

When configuring firewall filters for selective stateless packet-based services:

- Accurately identify traffic that needs to bypass flow to avoid unnecessary packet drops.
- Make sure to apply the firewall filter with `packet-mode` action on all interfaces involved in the packet-based flow path.
- Make sure to configure host-bound TCP traffic to use flow-based forwarding—exclude this traffic when specifying match conditions for the firewall filter term containing the `packet-mode` action modifier. Any host-bound TCP traffic configured to bypass flow is dropped. Asynchronous flow-mode processing is not supported with selective stateless packet-based services.
- Configure input packet filters (not output) with the `packet-mode` action modifier.

NOTE: Nested firewall filters (configuring a filter within the term of another filter) are not supported with selective stateless packet-based services.

Some typical deployment scenarios where you can configure selective stateless packet-based services are as follows:

- Traffic flow between private LAN and WAN interfaces, such as for Intranet traffic, where end-to-end forwarding is packet-based
- Traffic flow between private LAN and not-so-secure WAN interfaces, where traffic uses packet-based and flow-based forwarding for secure and not so secure traffic respectively
- Traffic flow between the private LAN and WAN interface with failover to flow-based IPsec WAN when the private WAN link is down
- Traffic flow from flow-based LAN to packet-based MPLS WAN

Example: Configuring Selective Stateless Packet-Based Services for End-to-End Packet-Based Forwarding

IN THIS SECTION

- [Requirements | 220](#)
- [Overview | 221](#)
- [Configuration | 222](#)
- [Verification | 230](#)

This example shows how to configure selective stateless packet-based services for end-to-end packet-based forwarding. This feature is supported on the SRX300, SRX320, SRX340, SRX345, SRX550M, SRX1500, and vSRX Virtual Firewall devices

Requirements

Before you begin:

- Understand how to configure stateless firewall filters.

- Establish basic connectivity. .

Overview

In this example, you configure the IP addresses for the interfaces on each of the devices. For R0 it is 10.1.1.2/24 ; for R1 they are 10.1.1.1/24, 10.2.1.1/24, and 203.0.113.1/30; for R2 it is 203.0.113.2/30; and for R3 it is 10.2.1.2/24. You create static routes and associate next-hop addresses for the devices as follows: R0 is 10.1.1.2, R1 is 198.51.100.2, R2 is 203.0.113.1, and R3 is 10.2.1.1.

Then on device R1 you configure a zone called untrust and assign it to interface ge-0/0/3. You also create a zone called trust and assign interfaces ge-0/0/1 and ge-0/0/2 to it. You configure trust and untrust zones to allow all supported application services as inbound services. You allow traffic from any source address, destination address, and application to pass between the zones.

You then create the firewall filter bypass-flow-filter and define the terms bypass-flow-term-1 and bypass-flow-term-2 that match the traffic between internal interfaces ge-0/0/1 and ge-0/0/2 and that contain the packet-mode action modifier. You define the term accept-rest to accept all remaining traffic. Finally, you apply the firewall filter bypass-flow-filter to internal interfaces ge-0/0/1 and ge-0/0/2 (not on the external interface). As a result, all internal traffic bypasses flow-based forwarding and the traffic to and from the Internet does not bypass flow-based forwarding.

Figure 26 on page 221 shows the network topology used in this example.

Figure 26: Intranet Traffic Using End-to-End Packet-Based Services

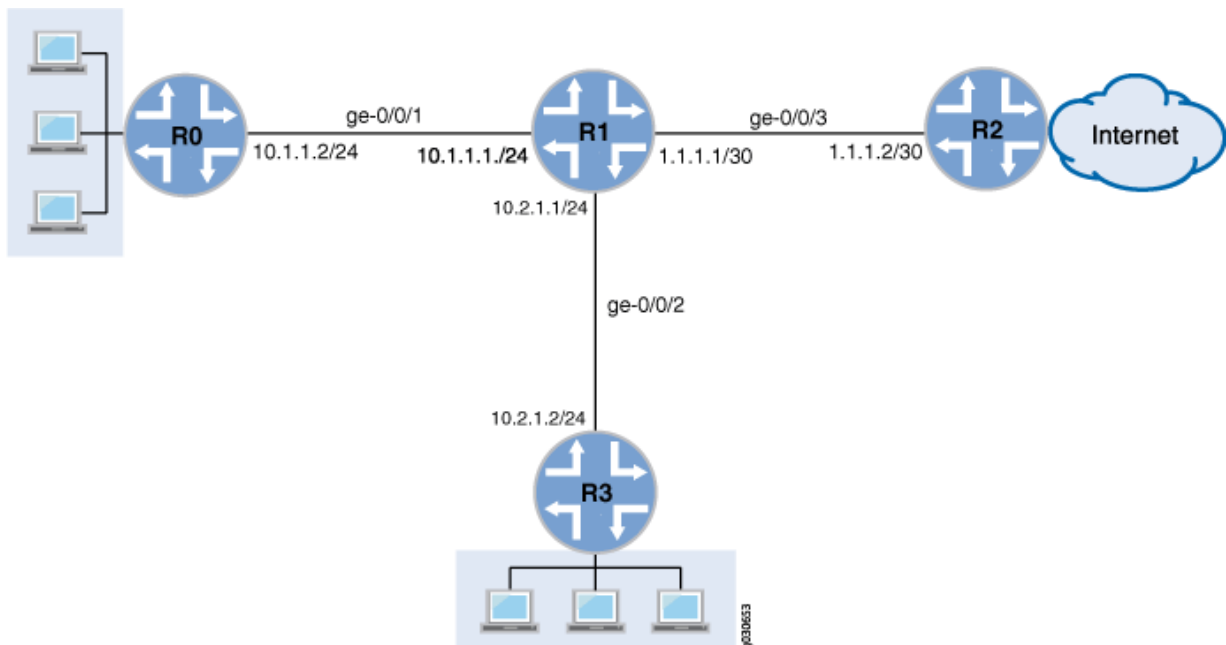

Your company's branch offices are connected to each other through a private WAN. For this internal traffic, packet forwarding is required because security is not an issue. Hence for this traffic, you decide to configure selective stateless packet-based services to bypass flow-based forwarding. The remaining traffic, to and from the Internet, uses flow-based forwarding.

Configuration

IN THIS SECTION

- [Procedure | 222](#)

Procedure

CLI Quick Configuration

To quickly configure this example, copy the following commands, paste them into a text file, remove any line breaks, change any details necessary to match your network configuration, and then copy and paste the commands into the CLI at the `[edit]` hierarchy level, and then enter `commit` from configuration mode.

```
{device R0}
[edit]
set interfaces ge-0/0/1 description "Internal 1" unit 0 family inet address 10.1.1.2/24
set routing-options static route 0.0.0.0/0 next-hop 10.1.1.1
```

```
{device R1}
set interfaces ge-0/0/1 description "Internal 1" unit 0 family inet address 10.1.1.1/24
set interfaces ge-0/0/2 description "Internal 2" unit 0 family inet address 10.2.1.1/24
set interfaces ge-0/0/3 description "Internet" unit 0 family inet address 203.0.113.1/30
set routing-options static route 0.0.0.0/0 next-hop 203.0.113.2
set security zones security-zone untrust interfaces ge-0/0/3
set security zones security-zone trust interfaces ge-0/0/1
set security zones security-zone trust interfaces ge-0/0/2
set security zones security-zone trust host-inbound-traffic system-services all
set security zones security-zone untrust host-inbound-traffic system-services all
set security policies from-zone trust to-zone untrust policy Internet-traffic match source-
address any destination-address any application any
set security policies from-zone trust to-zone untrust policy Internet-traffic then permit
set security policies from-zone untrust to-zone trust policy Incoming-traffic match source-
```

```

address any destination-address any application any
set security policies from-zone untrust to-zone trust policy Incoming-traffic then permit
set security policies from-zone trust to-zone trust policy Intrazone-traffic match source-
address any destination-address any application any
set security policies from-zone trust to-zone trust policy Intrazone-traffic then permit
set firewall family inet filter bypass-flow-filter term bypass-flow-term-1 from source-address
10.1.1.0/24
set firewall family inet filter bypass-flow-filter term bypass-flow-term-1 from destination-
address 10.2.1.0/24
set firewall family inet filter bypass-flow-filter term bypass-flow-term-1 then packet-mode
set firewall family inet filter bypass-flow-filter term bypass-flow-term-2 from source-address
10.2.1.0/24
set firewall family inet filter bypass-flow-filter term bypass-flow-term-2 from destination-
address 10.1.1.0/24
set firewall family inet filter bypass-flow-filter term bypass-flow-term-2 then packet-mode
set firewall family inet filter bypass-flow-filter term accept-rest then accept
set interfaces ge-0/0/1 description "Internal 1" unit 0 family inet filter input bypass-flow-
filer
set interfaces ge-0/0/2 description "Internal 2" unit 0 family inet filter input bypass-flow-
filer

```

```

{device R2}
set interfaces ge-0/0/3 description "Internet" unit 0 family inet address 10.1.1.2/30
set routing-options static route 0.0.0.0/0 next-hop 10.1.1.1

```

```

{device R3}
[edit]
set interfaces ge-0/0/2 description "Internal 2" unit 0 family inet address 10.21.1.2/24
set routing-options static route 0.0.0.0/0 next-hop 10.2.1.1

```

Step-by-Step Procedure

The following example requires you to navigate various levels in the configuration hierarchy. For instructions on how to do that, see *Using the CLI Editor in Configuration Mode* in the [CLI User Guide](#).

To configure selective stateless packet-based services for end-to-end packet-based forwarding:

1. Configure the IP addresses for the interfaces on devices R0, R1, R2, and R3.

```
{device R0}
[edit]
user@host# set interfaces ge-0/0/1 description "Internal 1" unit 0 family inet address 10.1.1.2/24
```

```
{device R1}
[edit]
user@host# set interfaces ge-0/0/1 description "Internal 1" unit 0 family inet address 10.1.1.1/24
user@host# set interfaces ge-0/0/2 description "Internal 2" unit 0 family inet address 10.2.1.1/24
user@host# set interfaces ge-0/0/3 description "Internet" unit 0 family inet address 203.0.113.1/30
```

```
{device R2}
[edit]
user@host# set interfaces ge-0/0/3 description "Internet" unit 0 family inet address 203.0.113.1/30
```

```
{device R3}
[edit]
user@host# set interfaces ge-0/0/2 description "Internal 2" unit 0 family inet address 10.2.1.2/24
```

2. Create static routes and associate the appropriate next-hop addresses for devices R0, R1, R2, and R3.

```
{device R0}
[edit]
user@host# set routing-options static route 0.0.0.0/0 next-hop 10.1.1.1
```

```
{device R1}
[edit]
user@host# set routing-options static route 0.0.0.0/0 next-hop 203.0.113.1
```

```
{device R2}
[edit]
user@host# set routing-options static route 0.0.0.0/0 next-hop 203.0.113.2
```

```
{device R3}
[edit]
user@host# set routing-options static route 0.0.0.0/0 next-hop 10.2.1.1
```

3. Configure security zones and assign interfaces.

```
{device R1}
[edit]
user@host# set security zones security-zone untrust interfaces ge-0/0/3
user@host# set security zones security-zone trust interfaces ge-0/0/1
user@host# set security zones security-zone trust interfaces ge-0/0/2
```

4. Configure application services for zones.

```
{device R1}
[edit]
user@host# set security zones security-zone trust host-inbound-traffic system-services all
user@host# set security zones security-zone untrust host-inbound-traffic system-services all
```

5. Configure a security policy

```
{device R1}
[edit]
user@host# set security policies from-zone trust to-zone untrust policy Internet-traffic match source-
address any destination-address any application any
user@host# set security policies from-zone trust to-zone untrust policy Internet-traffic then permit
user@host# set security policies from-zone untrust to-zone trust policy Incoming-traffic match source-
address any destination-address any application any
user@host# set security policies from-zone untrust to-zone trust policy Incoming-traffic then permit
user@host# set security policies from-zone trust to-zone trust policy Intrazone-traffic match source-
address any destination-address any application any
user@host# set security policies from-zone trust to-zone trust policy Intrazone-traffic then permit
```

6. Create a firewall filter and define terms for all the packet-based forwarding traffic.

```
{device R1}
[edit]
user@host# set firewall family inet filter bypass-flow-filter term bypass-flow-term-1 from source-
address 10.1.1.0/24
user@host# set firewall family inet filter bypass-flow-filter term bypass-flow-term-1 from destination-
address 10.2.1.0/24
user@host# set firewall family inet filter bypass-flow-filter term bypass-flow-term-1 then packet-mode
user@host# set firewall family inet filter bypass-flow-filter term bypass-flow-term-2 from source-
address 10.2.1.0/24
user@host# set firewall family inet filter bypass-flow-filter term bypass-flow-term-2 from destination-
address 10.1.1.0/24
user@host# set firewall family inet filter bypass-flow-filter term bypass-flow-term-2 then packet-mode
```

7. Specify another term for the remaining traffic.

```
{device R1}
[edit]
user@host# set firewall family inet filter bypass-flow-filter term accept-rest then accept
```

8. Apply the firewall filter to relevant interfaces.

```
{device R1}
[edit]
```

```

user@host# set interfaces ge-0/0/1 description "Internal 1" unit 0 family inet filter input bypass-flow-
filer
user@host# set interfaces ge-0/0/2 description "Internal 2" unit 0 family inet filter input bypass-flow-
filer

```

Results

From configuration mode, confirm your configuration by entering the `show interfaces`, `show routing-options`, and `show firewall` commands. If the output does not display the intended configuration, repeat the configuration instructions in this example to correct it.

```

{device R0}
[edit]
user@host# show interfaces
ge-0/0/1 {
  description "Internal 1"
  unit 0 {
    family inet {
      address 10.1.1.2/24
    }
  }
}

```

```

{device R0}
[edit]
user@host# show routing-options
static {
  route 0.0.0.0/0 next-hop 10.1.1.1;
}

```

```

{device R2}
[edit]
user@host# show interfaces
ge-0/0/3 {
  description "Internet"
  unit 0 {
    family inet {
      address 203.0.113.2/30;
    }
  }
}

```

```

    }
  }
}

```

```

{device R2}
[edit]
user@host# show routing-options
static {
    route 0.0.0.0/0 next-hop 203.0.113.1;
}

```

```

{device R3}
[edit]
user@host# show interfaces
ge-0/0/2 {
    description "Internal 2"
    unit 0 {
        family inet {
            address 10.2.1.2/24;
        }
    }
}

```

```

{device R3}
user@host# show routing-options
static {
    route 0.0.0.0/0 next-hop 10.2.1.1;
}

```

```

{device R1}
[edit]
user@host# show interfaces
ge-0/0/1 {
    description "internal 1"
    unit 0 {
        family inet {
            filter {

```

```

        input bypass-flow-filter;
    }
    address 10.1.1.1/24;
}
}
ge-0/0/2 {
    description "Internal 2"
    unit 0 {
        family inet {
            filter {
                input bypass-flow-filter;
            }
            address 10.2.1.1/24;
        }
    }
}
ge-0/0/3 {
    description "Internet"
    unit 0 {
        family inet {
            address 203.0.113.1/30;
        }
    }
}
{device R1}
[edit]
user@host# show routing-options
static {
    route 0.0.0.0/0 next-hop 203.0.113.1;
}
{device R1}
[edit]
user@host# show firewall
family inet {
    filter bypass-flow-filter {
        term bypass-flow-term-1 {
            from {
                source-address {
                    10.1.1.0/24;
                }
                destination-address {
                    10.2.1.0/24;
                }
            }
        }
    }
}

```

```

    }
  }
  then packet-mode;
}
term bypass-flow-term-2 {
  from {
    source-address {
      10.2.1.0/24;
    }
    destination-address {
      10.1.1.0/24;
    }
  }
  then packet-mode;
}
term accept-rest {
  then accept;
}
}
}
}

```

If you are done configuring the device, enter `commit` from configuration mode.

Verification

IN THIS SECTION

- [Verifying the End-to-End Packet-Based Configuration | 230](#)
- [Verifying Session Establishment on Intranet Traffic | 231](#)
- [Verifying Session Establishment on Internet Traffic | 233](#)

Confirm that the configuration is working properly.

Verifying the End-to-End Packet-Based Configuration

Purpose

Verify that the selective stateless packet-based services are configured.

Action

From configuration mode, enter the `show interfaces`, `show routing-options`, `show security zones`, `show security policies`, and `show firewall commands`.

Verify that the output shows the intended configuration of the firewall filter, interfaces, and policies.

Verify that the terms are listed in the order in which you want the packets to be tested. You can move terms within a firewall filter by using the `insert` command.

Verifying Session Establishment on Intranet Traffic

Purpose

Verify that sessions are established when traffic is transmitted to interfaces within the Intranet.

Action

To verify that sessions are established, perform the following tasks:

1. On device R1, enter the operational mode `clear security flow session all` command to clear all existing security flow sessions.
2. On device R0, enter the operational mode `ping` command to transmit traffic to device R3.
3. On device R1, with traffic transmitting from devices R0 to R3 through R1, enter the operational mode `show security flow session` command.

```
Flow Sessions on FPC10 PIC1:
```

```
Total sessions: 0
```

```
Flow Sessions on FPC10 PIC2:
```

```
Total sessions: 0
```

```
Flow Sessions on FPC10 PIC3:
```

```
Total sessions: 0
```

NOTE: To verify established sessions, make sure to enter the `show security flow session` command while the `ping` command is sending and receiving packets.

Starting in Junos OS Release 15.1X49-D30 and Junos OS Release 17.3R1, the session flow summaries include CP session IDs.

```
{device R0}
user@host> ping 192.0.2.2 -c 10
```

```
PING 192.0.2.2 (192.0.2.2) 56(84) bytes of data.
64 bytes from 192.0.2.2: icmp_seq=1 ttl=63 time=6.07 ms
64 bytes from 192.0.2.2: icmp_seq=2 ttl=63 time=4.24 ms
64 bytes from 192.0.2.2: icmp_seq=3 ttl=63 time=2.85 ms
64 bytes from 192.0.2.2: icmp_seq=4 ttl=63 time=6.14 ms
...
```

```
{device R1}
user@host>show security flow session
```

Flow Sessions on FPC10 PIC1:

```
Session ID: 41000077, Policy name: Internet-traffic/5, Timeout: 2, Valid
  In: 198.51.100.1/3 --> 192.0.2.2/32055;icmp, If: ge-7/1/0.0, Pkts: 1, Bytes: 84, CP Session
  ID: 410000198
  Out: 192.0.2.2/32055 --> 198.51.100.1/3;icmp, If: ge-7/1/1.0, Pkts: 1, Bytes: 84, CP Session
  ID: 410000198
Total sessions: 1
```

Flow Sessions on FPC10 PIC2:

```
Session ID: 42000079, Policy name: Internet-traffic/5, Timeout: 2, Valid
  In: 198.51.100.1/5 --> 192.0.2.2/32055;icmp, If: ge-7/1/0.0, Pkts: 1, Bytes: 84, CP Session
  ID: 420000163
  Out: 192.0.2.2/32055 --> 198.51.100.1/5;icmp, If: ge-7/1/1.0, Pkts: 1, Bytes: 84, CP Session
  ID: 420000163
Total sessions: 1
```

Flow Sessions on FPC10 PIC3:

```
Session ID: 430000090, Policy name: Internet-traffic/5, Timeout: 4, Valid
  In:198.51.100.1/7 --> 192.0.2.2/32055;icmp, If: ge-7/1/0.0, Pkts: 1, Bytes: 84, CP Session ID:
430000088
  Out: 192.0.2.2/32055 --> 198.51.100.1/7;icmp, If: ge-7/1/1.0, Pkts: 1, Bytes: 84, CP Session
ID: 430000088
Total sessions: 1
```

The output shows traffic transmitting from R0 to R3 and no sessions are established. In this example, you applied the `bypass-flow-filter` with the `packet-mode` action modifier on interfaces Internal 1 and Internal 2 for your company's Intranet traffic. This output verifies that the traffic between the two interfaces is correctly bypassing flow-based forwarding and hence no sessions are established.

Verifying Session Establishment on Internet Traffic

Purpose

Verify that sessions are established when traffic is transmitted to the Internet.

Action

To verify that traffic to the Internet is using flow-based forwarding and sessions are established, perform the following tasks:

1. On device R1, enter the operational mode `clear security flow session all` command to clear all existing security flow sessions.
2. On device R0, enter the operational mode `ping` command to transmit traffic to device R2.
3. On device R1, with traffic transmitting from R0 to R2 through R1, enter the operational mode `show security flow session` command.

NOTE: To verify established sessions, make sure to enter the `show security flow session` command while the `ping` command is sending and receiving packets.

```
{device R0}
user@host> ping 203.0.113.6
```

```
PING 203.0.113.6 (203.0.113.6): 56 data bytes
64 bytes from 203.0.113.6: icmp_seq=0 ttl=63 time=2.326 ms
64 bytes from 203.0.113.6: icmp_seq=1 ttl=63 time=2.569 ms
64 bytes from 203.0.113.6: icmp_seq=2 ttl=63 time=2.565 ms
64 bytes from 203.0.113.6: icmp_seq=3 ttl=63 time=2.563 ms
64 bytes from 203.0.113.6: icmp_seq=4 ttl=63 time=2.306 ms
64 bytes from 203.0.113.6: icmp_seq=5 ttl=63 time=2.560 ms
64 bytes from 203.0.113.6: icmp_seq=6 ttl=63 time=4.130 ms
64 bytes from 203.0.113.6: icmp_seq=7 ttl=63 time=2.316 ms
...
```

```
{device R1}
user@host> show security flow session
```

```
Flow Sessions on FPC10 PIC1:
Total sessions: 0

Flow Sessions on FPC10 PIC2:
Total sessions: 0

Flow Sessions on FPC10 PIC3:
Total sessions: 0
```

The output shows traffic transmitting from devices R0 to R1 and established sessions. In this example, you did not apply the `bypass-flow-filter` with the `packet-mode` action modifier on interface Internet for your company's Internet traffic. This output verifies that the traffic to the Internet is correctly using flow-based forwarding and hence sessions are established.

Transmit traffic from device R3 to R2 and use the commands in this section to verify established sessions.

Example: Configuring Selective Stateless Packet-Based Services for Packet-Based to Flow-Based Forwarding

IN THIS SECTION

- [Requirements | 235](#)
- [Overview | 235](#)
- [Configuration | 236](#)
- [Verification | 245](#)

This example shows how to configure selective stateless packet-based services for packet-based to flow-based forwarding. This feature is supported on SRX300, SRX320, SRX340, SRX345, SRX550M, SRX1500, and vSRX Virtual Firewall devices.

Requirements

Before you begin:

- Understand how to configure stateless firewall filters.
- Establish basic connectivity. .

Overview

In this example, you configure the IP addresses for the interfaces on each of the devices. For device R0 as 198.51.100.9/24; for R1 the are 198.51.100.10/24 and 203.0.113.5/24; and for R2 it is 203.0.113.9/24. On device R1, you set an internal service interface lt-0/0/0 between routing instances and configure a peer relationship between two virtual devices. You then create two security zones, Primary-VR-zone and Internet-VR-zone, assign related interfaces to them, and configure them to allow all supported applications and protocols.

Then you configure policies and specify that all packets are permitted. You configure a virtual device routing instance Internet-VR and assign interfaces for flow-based forwarding. You enable OSPF on devices R0, R1, and R2. On Device R2, you configure the filter bypass-flow-filter with the term bypass-flow-term that contains the packet-mode action modifier. Because you have not specified any match conditions, this filter applies to all traffic that traverses the interfaces on which it is applied.

Finally, on device R1 you apply the firewall filter bypass-flow-filter to internal interfaces ge-0/0/2.0 and lt-0/0/0.0. You do not apply the filter to the interfaces associated with the Internet-VR routing instance. As a result, all traffic that traverses the LAN interfaces associated with the primary routing instance uses

packet-based forwarding and all traffic that traverses the Internet-VR routing instance uses flow-based forwarding.

Figure 27 on page 236 shows the network topology used in this example.

Figure 27: Selective Stateless Packet-Based Services for Packet-Based Forwarding

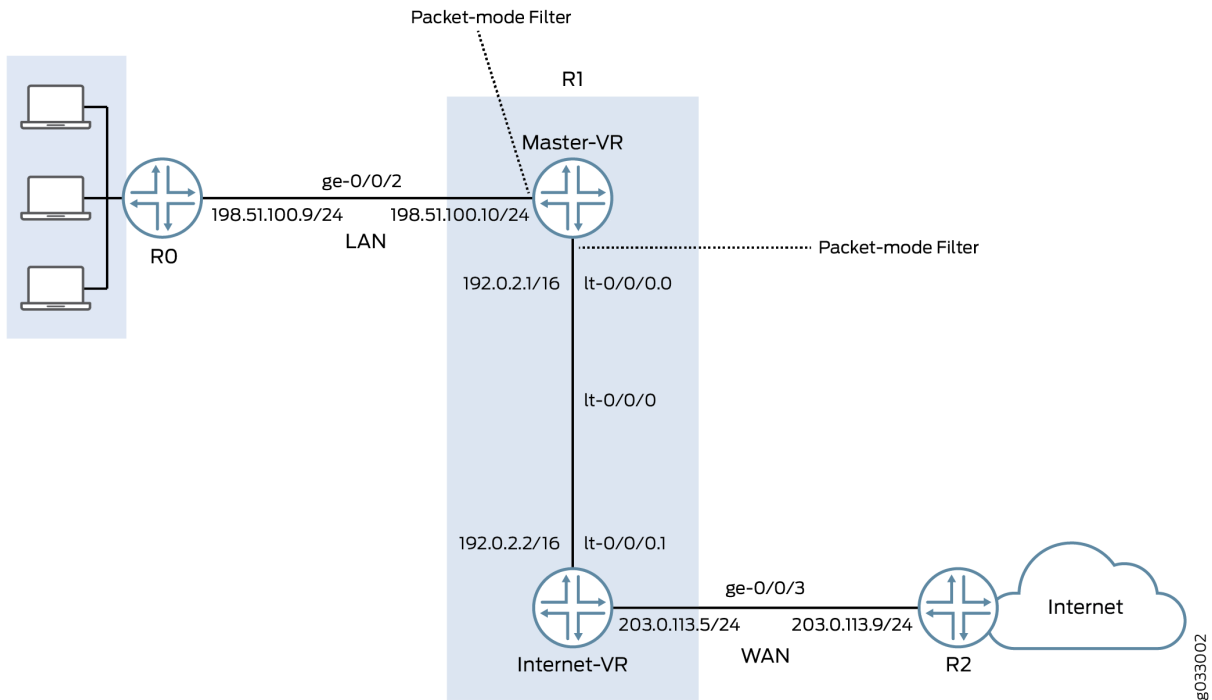

The interface facing the private LAN does not need any security services, but the interface facing the WAN needs security. In this example, you decide to configure both packet-based and flow-based forwarding for secure and not so secure traffic by configuring two routing instances—one handling the packet-based forwarding and the other handling the flow-based forwarding.

Configuration

IN THIS SECTION

- Procedure | 237

Procedure

CLI Quick Configuration

To quickly configure this example, copy the following commands, paste them into a text file, remove any line breaks, change any details necessary to match your network configuration, and then copy and paste the commands into the CLI at the [edit] hierarchy level, and then enter `commit` from configuration mode.

```
{device R0}
set interfaces description "Connect to Primary VR" ge-0/0/2 unit 0 family inet address
198.51.100.9/24
set protocols ospf area 0.0.0.0 interface ge-0/0/2.0
```

```
{device R1}
set interfaces description "Connect to R0" ge-0/0/2 unit 0 family inet address 198.51.100.10/24
set interfaces description "Connect to R2" ge-0/0/3 unit 0 family inet address 203.0.113.5/24
set interfaces lt-0/0/0 unit 0 encapsulation frame-relay dlci 100 peer-unit 1 family inet
address 192.0.2.1/16
set interfaces lt-0/0/0 unit 1 encapsulation frame-relay dlci 100 peer-unit 0 family inet
address 192.0.2.2/16
set security zones security-zone Primary-VR-zone host-inbound-traffic system-services all
set security zones security-zone Primary-VR-zone host-inbound-traffic protocols all
set security zones security-zone Primary-VR-zone interfaces ge-0/0/2.0
set security zones security-zone Primary-VR-zone interfaces lt-0/0/0.0
set security zones security-zone Internet-VR-zone host-inbound-traffic system-services all
set security zones security-zone Internet-VR-zone host-inbound-traffic protocols all
set security zones security-zone Internet-VR-zone interfaces ge-0/0/3.0
set security zones security-zone Internet-VR-zone interfaces lt-0/0/0.1
set security policies default-policy permit-all
set routing-instances Internet-VR instance-type virtual-router interface lt-0/0/0.1
set routing-instances Internet-VR instance-type virtual-router interface ge-0/0/3.0
set protocols ospf area 0.0.0.0 interface ge-0/0/2.0
set protocols ospf area 0.0.0.0 interface lt-0/0/0.0
set routing-instances Internet-VR protocols ospf area 0.0.0.0 interface lt-0/0/0.1
set routing-instances Internet-VR protocols ospf area 0.0.0.0 interface ge-0/0/3.0
set firewall family inet filter bypass-flow-filter term bypass-flow-term then accept
set firewall family inet filter bypass-flow-filter term bypass-flow-term then packet-mode
```

```
set interfaces ge-0/0/2 unit 0 family inet filter input bypass-flow-filter
set interfaces lt-0/0/0 unit 0 family inet filter input bypass-flow-filter
```

```
{device R2}
set interfaces description "Connect to Internet-VR" ge-0/0/3 unit 0 family inet address
203.0.113.9/24
set protocols ospf area 0.0.0.0 interface ge-0/0/3
```

Step-by-Step Procedure

The following example requires you to navigate various levels in the configuration hierarchy. For instructions on how to do that, see *Using the CLI Editor in Configuration Mode* in the [CLI User Guide](#).

To configure selective stateless packet-based services for end-to-end packet-based forwarding:

1. Configure the IP addresses for the interfaces.

```
{device R0}
[edit]
user@host# set interfaces description "Connect to Primary VR" ge-0/0/2 unit 0 family inet address
198.51.100.9/24
```

```
{device R1}
[edit]
user@host# set interfaces description "Connect to R0" ge-0/0/2 unit 0 family inet address
198.51.100.10/24
user@host# set interfaces description "Connect to R2" ge-0/0/3 unit 0 family inet address
203.0.113.5/24
```

```
{device R2}
[edit]
user@host# set interfaces description "Connect to Internet-VR" ge-0/0/3 unit 0 family inet address
203.0.113.9/24
```

2. Set an internal service interface between routing instances.

```
{device R1}
[edit]
user@host# set interfaces lt-0/0/0 unit 0 encapsulation frame-relay dlci 100 peer-unit 1 family inet
address 192.0.2.1/16
user@host# set interfaces lt-0/0/0 unit 1 encapsulation frame-relay dlci 100 peer-unit 0 family inet
address 192.0.2.2/16
```

3. Configure security zones.

```
{device R1}
[edit]
user@host# set security zones security-zone Primary-VR-zone host-inbound-traffic system-services all
user@host# set security zones security-zone Primary-VR-zone host-inbound-traffic protocols all
user@host# set security zones security-zone Primary-VR-zone interfaces ge-0/0/2.0
user@host# set security zones security-zone Primary-VR-zone interfaces lt-0/0/0.0
user@host# set security zones security-zone Internet-VR-zone host-inbound-traffic system-services all
user@host# set security zones security-zone Internet-VR-zone host-inbound-traffic protocols all
user@host# set security zones security-zone Internet-VR-zone interfaces ge-0/0/3.0
user@host# set security zones security-zone Internet-VR-zone interfaces lt-0/0/0.1
```

4. Configure policies.

```
{device R1}
[edit]
user@host# set security policies default-policy permit-all
```

5. Configure a virtual device routing instance.

```
{device R1}
[edit]
user@host# set routing-instances Internet-VR instance-type virtual-router interface lt-0/0/0.1
user@host# set routing-instances Internet-VR instance-type virtual-router interface ge-0/0/3.0
```

6. Enable OSPF on all interfaces in the network.

```
{device R0}
[edit]
user@host# set protocols ospf area 0.0.0.0 interface ge-0/0/2.0
```

```
{device R1 for Primary-VR}
[edit]
user@host# set protocols ospf area 0.0.0.0 interface ge-0/0/2.0
user@host# set protocols ospf area 0.0.0.0 interface lt-0/0/0.0
```

```
{device R1 for Internet-VR}
[edit]
user@host# set routing-instances Internet-VR protocols ospf area 0.0.0.0 interface lt-0/0/0.1
user@host# set routing-instances Internet-VR protocols ospf area 0.0.0.0 interface ge-0/0/3.0
```

```
{device R2}
[edit]
user@host# set protocols ospf area 0.0.0.0 interface ge-0/0/3
```

7. Create a firewall filter and define a term for packet-based forwarding traffic.

```
{device R1}
[edit]
user@host# set firewall family inet filter bypass-flow-filter term bypass-flow-term then accept
user@host# set firewall family inet filter bypass-flow-filter term bypass-flow-term then packet-mode
```

8. Apply the firewall filter to relevant interfaces.

```
{device R1}
[edit]
user@host# set interfaces ge-0/0/2 unit 0 family inet filter input bypass-flow-filter
user@host# set interfaces lt-0/0/0 unit 0 family inet filter input bypass-flow-filter
```

Results

From configuration mode, confirm your configuration by entering the `show interfaces`, `show protocols`, `show security`, `show routing-instances`, and `show firewall` commands. If the output does not display the intended configuration, repeat the configuration instructions in this example to correct it.

```
{device R0}
[edit]
user@host# show interfaces
ge-0/0/2 {
  description "Connect to Primary-VR"
  unit 0 {
    family inet {
      address 198.51.100.9/24
    }
  }
}
```

```
{device R0}
[edit]
user@host# show protocols
ospf {
  area 0.0.0.0/0 {
    interface ge-0/0/2.0;
  }
}
```

```
{device R2}
[edit]
user@host# show interfaces
ge-0/0/3 {
  description "Connect to Internet-VR"
  unit 0 {
    family inet {
      address 203.0.113.9/24;
    }
  }
}
```

```

}
}

```

```

{device R2}
[edit]
user@host# show protocols
ospf {
  area 0.0.0.0/0 {
    interface ge-0/0/3.0;
  }
}

```

```

{device R1}
[edit]
user@host# show interfaces
ge-0/0/2 {
  description "Connect to R0"
  unit 0 {
    family inet {
      filter {
        input bypass-flow-filter;
      }
      address 198.51.100.10/24;
    }
  }
}
lt-0/0/0 {
  unit 0 {
    encapsulation frame-relay;
    dlci 100;
    peer-unit 1;
    family inet {
      filter {
        input bypass-flow-filter
      }
      address 192.0.2.1/16;
    }
  }
  unit 1{
    encapsulation frame-relay;

```

```

        dlci 100;
        peer-unit 0;
        family inet {
            address 192.0.2.2/16 ;
        }
    }
}
{device R1}
[edit]
user@host# show protocols
ospf {
    area 0.0.0.0/0 {
        interface ge-0/0/2.0;
        interface lt-0/0/0.0;
    }
}
{device R1}
[edit]
user@host# show firewall
filter bypass-flow-filter {
    term bypass-flow-term {
        then {
            packet-mode;
            accept;
        }
    }
}
}

```

```

{device R1}
[edit]
user@host# show routing-instances
Internet-VR {
    instance-type virtual-router;
    interface lt-0/0/0.1;
    interface ge-0/0/3.0;
    protocols {
        ospf {
            area 0.0.0.0 {
                interface ge-0/0/3.0;
                lt-0/0/0.1;
            }
        }
    }
}

```

```

    }
  }
}

```

```

{device R1}
[edit]
user@host# show security
security zone Primary-VR-zone {
  host-inbound-traffic {
    system-services {
      all;
      {
        protocols {
          all;
        }
      }
    }
    interfaces {
      ge-0/0/2.0;
      lt-0/0/0.0;
    }
  }
}
security zone Internet-VR-zone {
  host-inbound-traffic {
    system-services {
      all;
      {
        protocols {
          all;
        }
      }
    }
    interfaces {
      ge-0/0/3.0;
      lt-0/0/0.1;
    }
  }
}
policies {
  default-policy {
    permit-all;
  }
}
}

```

If you are done configuring the device, enter `commit` from configuration mode.

Verification

IN THIS SECTION

- [Verifying the Packet-Based to Flow-Based Configuration | 245](#)
- [Verifying Session Establishment on LAN Traffic | 245](#)
- [Verifying Session Establishment on Internet Traffic | 247](#)

Confirm that the configuration is working properly.

Verifying the Packet-Based to Flow-Based Configuration

Purpose

Verify that the selective stateless packet-based services are configured for packet-based to flow-based forwarding.

Action

From configuration mode, enter the `show interfaces`, `show protocols`, `show security`, `show routing-instances`, and `show firewall` commands.

Verify that the output shows the intended configuration of the firewall filter, routing instances, interfaces, and policies.

Verify that the terms are listed in the order in which you want the packets to be tested. You can move terms within a firewall filter by using the `insert` command.

Verifying Session Establishment on LAN Traffic

Purpose

Verify that the sessions are established when traffic is transmitted on interfaces within the LAN.

Action

To verify that sessions are established, perform the following tasks:

1. On device R1, from operational mode enter the `clear security flow session all` command to clear all existing security flow sessions.
2. On device R0, from operational mode enter the `ping` command to transmit traffic to device Primary-VR.
3. On device R1, with traffic transmitting from devices R0 through R1, from operational mode enter the `show security flow session` command.

NOTE: To verify established sessions, ensure that you enter the `show security flow session` command while the `ping` command is sending and receiving packets.

```
{device R0}
user@host> ping 192.0.2.1
```

```
PING 192.0.2.1 (192.0.2.1): 56 data bytes
64 bytes from 192.0.2.1: icmp_seq=0 ttl=63 time=2.208 ms
64 bytes from 192.0.2.1: icmp_seq=1 ttl=63 time=2.568 ms
64 bytes from 192.0.2.1: icmp_seq=2 ttl=63 time=2.573 ms
64 bytes from 192.0.2.1: icmp_seq=3 ttl=63 time=2.310 ms
64 bytes from 192.0.2.1: icmp_seq=4 ttl=63 time=1.566 ms
64 bytes from 192.0.2.1: icmp_seq=5 ttl=63 time=1.569 ms
...
```

```
{device R1}
user@host> show security flow session
```

```
0 sessions displayed
```

The output shows traffic transmitting from R0 to Primary-VR and no sessions are established. In this example, you applied the `bypass-flow-filter` with the `packet-mode` action modifier on interfaces `ge-0/0/0` and `lt-0/0/0.0` for your company's LAN traffic. This output verifies that the traffic between the two interfaces is correctly bypassing flow-based forwarding and hence no sessions are established.

Verifying Session Establishment on Internet Traffic

Purpose

Verify that sessions are established when traffic is transmitted to the Internet.

Action

To verify that traffic to the Internet is using flow-based forwarding and sessions are established, perform the following tasks:

1. On device R1, from operational mode enter the `clear security flow session all` command to clear all existing security flow sessions.
2. On device R0, from operational mode enter the `ping` command to transmit traffic to device R2.
3. On device R1, with traffic transmitting from R0 to R2 through R1, from operational mode enter the `show security flow session` command.

```
root@host> show security flow session
Flow Sessions on FPC10 PIC1:
Total sessions: 0

Flow Sessions on FPC10 PIC2:
Total sessions: 0

Flow Sessions on FPC10 PIC3:
Total sessions: 0
```

NOTE: To verify established sessions, ensure that you enter the `show security flow session` command while the `ping` command is sending and receiving packets.

```
{device R0}
user@host> ping 192.0.2.1 -c 10
```

```
PING 60.0.0.1 (60.0.0.1) 56(84) bytes of data.
64 bytes from 192.0.2.1: icmp_seq=1 ttl=64 time=1.98 ms
64 bytes from 192.0.2.1: icmp_seq=2 ttl=64 time=1.94 ms
```

```
64 bytes from 192.0.2.1: icmp_seq=3 ttl=64 time=1.92 ms
64 bytes from 192.0.2.1: icmp_seq=4 ttl=64 time=1.89 ms
...
```

```
{device R1}
user@host> show security flow session
```

```
Session ID: 189900, Policy name: default-policy/2, Timeout: 2
  In: 198.51.100.9/0 --> 192.0.2.1/5924;icmp, If: lt-0/0/0.1
  Out: 192.0.2.1/5924 --> 198.51.100.9/0;icmp, If: ge-0/0/3.0

Session ID: 189901, Policy name: default-policy/2, Timeout: 2
  In: 198.51.100.9/1 --> 192.0.2.1/5924;icmp, If: lt-0/0/0.1
  Out: 192.0.2.1/5924 --> 198.51.100.9/1;icmp, If: ge-0/0/3.0

Session ID: 189902, Policy name: default-policy/2, Timeout: 4
  In: 198.51.100.9/2 --> 192.0.2.1/5924;icmp, If: lt-0/0/0.1
  Out: 192.0.2.1/5924 --> 198.51.100.9/2;icmp, If: ge-0/0/3.0

3 sessions displayed
```

The output shows traffic transmitting from devices R0 to R2 and established sessions. In this example, you did not apply the `bypass-flow-filter` with the `packet-mode` action modifier on routing instance Internet-VR for your company's Internet traffic. This output verifies that the traffic to the Internet is correctly using flow-based forwarding and hence sessions are established.

Note that sessions are established only when traffic is flowing between `lt-0/0/0.1` and `ge-0/0/3` and not when traffic is flowing between `ge-0/0/2` and `lt-0/0/0.0`.

Release History Table

Release	Description
15.1X49-D30	Starting in Junos OS Release 15.1X49-D30 and Junos OS Release 17.3R1, the session flow summaries include CP session IDs.

RELATED DOCUMENTATION

| [Express Path Overview](#) | 252

Reverse Route Packet Mode using Virtual Router

IN THIS SECTION

- [Understanding To-host Traffic on Virtual Router | 251](#)

During flow processing, when the traffic route between the server and client is changed, the traffic reroutes using the virtual router (VR). The VR used in rerouting is available in the interface or the filter-based forwarding (FBF). The behavior of the reroute is monitored using the `set security flow advanced-options reverse-route-packet-mode-vr` command.

NOTE: The `reverse-route-packet-mode-vr` command works on root logical system and is enabled globally.

When the reverse route option is enabled, there is no change in the packet flow. When the reverse route option is disabled, the route lookup uses the VR from the packet incoming interface. If the VR in the route is incorrectly configured, then the traffic between the server and client is dropped.

NOTE: The resolve reserve route in the flow first path is not configured as the VR information from the client to the server packet is not available.

For example, [Figure 28 on page 250](#) shows the behavior of the packet flow when the `reverse-route-packet-mode-vr` command is not configured. The client to server traffic uses the routing instance VR2 of incoming interface `ge-0/0/0.0` to route the traffic. The server to client traffic also uses the routing instance VR2 of incoming interface `ge-0/0/0.0` to route the traffic.

Figure 28: Reverse Route Disabled

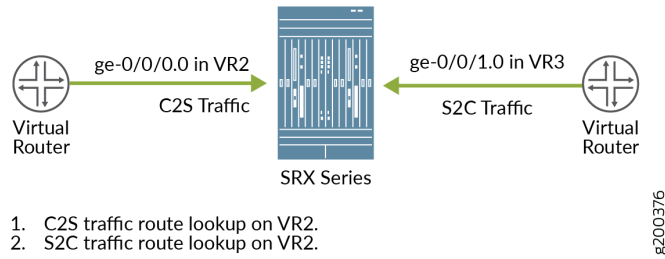

Figure 29 on page 250 shows the behavior of the packet flow when the `reverse-route-packet-mode-vr` command is configured using interface. The client to server traffic uses the routing instance VR2 of incoming interface `ge-0/0/0.0` to route the traffic. The server to client traffic uses the routing instance VR3 of interface `ge-0/0/1.0` to route the traffic.

Figure 29: Reverse Route Enabled with Interface

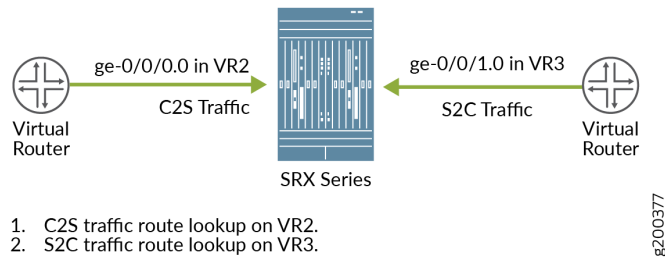
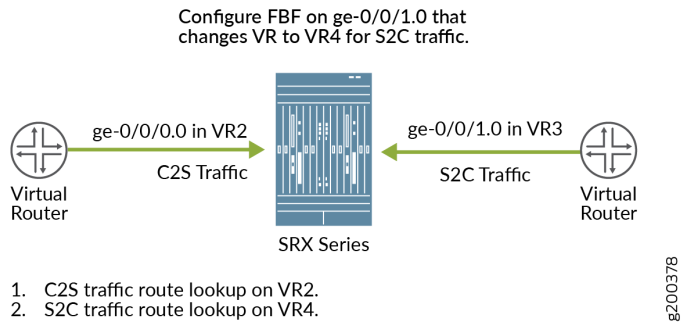

Figure 30 on page 251 shows the behavior of the packet flow when the `reverse-route-packet-mode-vr` command is configured using FBF. The client to server traffic uses the packet incoming interface `ge-0/0/0.0` in VR2 to route the traffic. Configuring FBF on the interface `ge-0/0/1.0` changes VR3 to VR4. The server to client traffic uses VR4 to route the traffic.

Figure 30: Reverse Route Enabled with FBF



Understanding To-host Traffic on Virtual Router

On a SRX Series Firewall, all the traffic that passes the firewall filter is referred as to-host traffic. The traffic from the firewall to the device is referred as the from-host traffic. The to-host traffic uses an egress interface and the from-host traffic uses an ingress interface. If both the interfaces are not in the same routing instance, there will be a session mismatched. To overcome this issue, the to-host and the from-host traffic choose interfaces that are available in the same routing instance.

Figure 31 on page 251 shows the to-host traffic using the routing instance VR5 of interface ge-0/0/0.0 and the routing instance VR6 of destination interface lo0.1.

Figure 31: To-host Traffic on VR

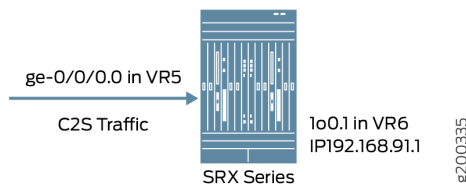

For example, if the to-host traffic uses a local interface (such as local...X) that is in routing instance 5 (VR5), and the from-host traffic uses the interface in routing instance 6 (VR6). The session output displaying the interface information of the to-host traffic is:

```
Session ID: 10000179, Policy name: pol1/4, Timeout: 2, Valid
  In: 192.168.90.1/4 --> 192.168.91.1/19050;icmp, Conn Tag: 0x0, If: xe-9/0/3.0, Pkts: 1, Bytes:
84, CP Session ID: 10000178
```

```
Out: 192.168.91.1/19050 --> 192.168.90.1/4;icmp, Conn Tag: 0x0, If: .local..5, Pkts: 1, Bytes:
84, CP Session ID: 10000178
```

NOTE: The session output displays the local interface of the to-host traffic as local....5.

To synchronize the to-host and from-host traffics, the to-host traffic uses traffic destination IP interface (lo0.1) that is available in VR6. As the from-host traffic is using the interface available in VR6, the session matches. The session output displaying the interface information of the to-host traffic is:

```
Session ID: 10000179, Policy name: pol1/4, Timeout: 2, Valid
  In: 192.168.90.1/4 --> 192.168.91.1/19050;icmp, Conn Tag: 0x0, If: xe-9/0/3.0, Pkts: 1, Bytes:
84, CP Session ID: 10000178
  Out: 192.168.91.1/19050 --> 192.168.90.1/4;icmp, Conn Tag: 0x0, If: .local..6, Pkts: 1, Bytes:
84, CP Session ID: 10000178
```

NOTE: The session output displays the local interface of the to-host traffic as local....6.

RELATED DOCUMENTATION

| [Packet-Based Forwarding](#) | 215

Express Path Overview

IN THIS SECTION

- [Automated Express Path](#) | 255
- [How does Express Path Process the Traffic?](#) | 255
- [Platforms That Support Express Path](#) | 256
- [How to Enable Express Path](#) | 257
- [Express Path Network Processor](#) | 257

- Express Path Packet Processing on IOC cards | 260
- Example: Configure Express Path on SRX5400, SRX5600, or SRX5800 Device with an IOC card | 262

Express Path (formerly known as *services offloading*) is a mechanism for processing fast-path packets in the network processor instead of in the Services Processing Unit (SPU). Express Path increases the performance by offloading certain traffic from SPU to network processors.

When you create an Express Path session on the network processor, subsequent packets of the flow match the session on the network processors. The network processor then processes and forwards the packet.

The network processor also manages additional processing such as TCP sequence check, time-to-live (TTL) processing, Network Address Translation (NAT), and Layer 2 header translation. The flow table on the IOC3 is managed by the SPU of the flow module. The SPU inserts and deletes flow entries in the flow table based on policy matching results. Express Path supports IPv6.

The figure shows the packet flow in Express Path.

Figure 32: Packet flow and Express Path

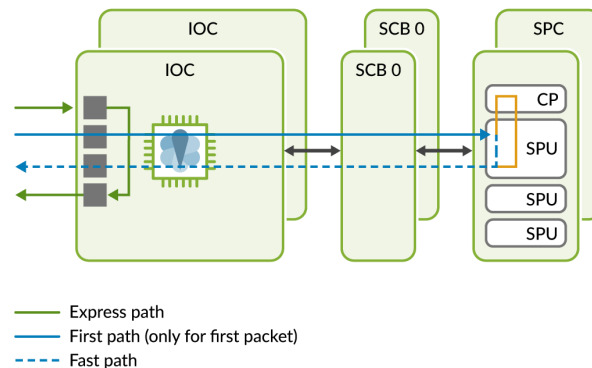

Benefits of Express Path

- Significantly improves single-flow and chassis-level performance.
- Reduces SPU utilization and latency.

Express Path Limitations

Express Path does not support:

- Features
 - Transparent Mode
 - Multicast session with more than one fan-out
 - Fragmented packets
 - IPsec VPN
 - Different MTU size values
- Application Layer Gateway (ALG) data traffic:
 - DNS
 - IKE and ESP
 - PPTP
 - SQL-NET
- IPv6
 - NAT
 - Transparent mode
 - Different MTU size values
 - Class of Service (CoS) on egress interfaces

Express path and packet offloading doesn't work when you use firewall filters to direct traffic into a virtual router,

If you enable Express Path on a device operating in chassis cluster mode:

- You cannot configure asymmetric I/O cards (IOC).
- If a child link from the LACP-enabled reth interface goes down, all traffic on this link is distributed to other active child links of the interface. If the child link comes up and rejoins the reth interface, then the existing traffic or sessions are not redistributed over this newly rejoined active child link. New sessions traverse through this link.
- If a new child link is added to the LACP-enabled reth interface, then the existing traffic or sessions are not redistributed over this new child link. New sessions traverse this link.

Automated Express Path

On SRX4600, SRX5400, SRX5600, and SRX5800 devices, Automated Express Path is by default enabled from Junos OS Release 21.2R1. When you upgrade to Junos Release 21.2R1 or later, you unlock free, unparalleled next-generation firewall performance, without any additional configuration or hardware investment. By default, an automated Express Path is enabled.

In Junos OS Release 21.2R1 to disable the Express Path per rule, use `set security policies from-zone [untrust] to-zone ptrust] policy [services-offload-pol1] then permit no-services-offload` command.

To revert to previous behavior by enabling services-offload per rule, use the `set security forwarding-options services-offload disable` command.

Automated Express Path supports the following features:

- Stateful Firewall
- Network Address Translation (NAT)
- Unified-Policies (with Dynamic-Applications and URL-Categories)
- User-Firewall
- Security Intelligence
- Intrusion Detection and Prevention (IDP)
- Enhanced Web-Filtering
- Application Layer Gateways (ALG)
- Screens (Anti-DDoS)

How does Express Path Process the Traffic?

When the first packet arrives at an interface, the network processor forwards it to the central point (CP). The central point in turn forwards the packet to the SPU. The SPU then creates a session on the network processor and verifies if the traffic qualifies for the Express Path session or a normal session.

If the traffic qualifies for Express Path processing, an Express Path session for the traffic is created in the SPU. The Express Path session processes the fast-path packets in the network processor, and the packets exit from the network processor.

If the traffic doesn't qualify for Express Path processing, the SPU creates a normal session. The normal session forwards packets from the network processor to the SPU for fast-path processing,

Platforms That Support Express Path

The SRX4600, SRX5400, SRX5600, and SRX5800 devices support Express Path.

[Table 15 on page 256](#) provides details about the Express Path support on different SRX Series cards.

Table 15: Express Path Support on SRX Series Firewall Cards

SRX Series Firewall	Card Name and Model Number	Earliest Supported Release
SRX5600, SRX5800	SRX5K-40GE-SFP	Junos OS Release 11.4
SRX5600, SRX5800	SRX5K-4XGE-XFP	Junos OS Release 11.4
SRX5600, SRX5800	SRX5K-FPC-IOC containing one of the following cards: <ul style="list-style-type: none"> SRX-IOC-16GE-TX SRX-IOC-4XGE-XFP SRX-IOC-16GE-SFP 	Junos OS Release 11.4
SRX5400, SRX5600, SRX5800	SRX5K-MPC containing one of the following MICs: <ul style="list-style-type: none"> SRX-MIC-10XGE-SFFP SRX-MIC-2X40GE-OSFP SRX-MIC-1X100GE-CFP SRX-MIC-20GE-SFP 	Junos OS Release 12.3X48-D10
SRX5400, SRX5600, SRX5800	SRX5K-MPC3 (IOC3) containing one of the following MPCs: <ul style="list-style-type: none"> SRX5K-MPC3-40G10G (24x10GE + 6x40GE MPC) SRX5K-MPC3-100G10G (2x100GE + 4x10GE MPC) 	Junos OS Release 15.1X49-D10
SRX5400, SRX5600, SRX5800	SRX5K-IOC4-10G (IOC4) SRX5K-IOC4-MRAT	Junos OS Release 19.3R1

Table 15: Express Path Support on SRX Series Firewall Cards (Continued)

SRX Series Firewall	Card Name and Model Number	Earliest Supported Release
SRX4600	Not Applicable	Junos OS Release 19.2R1

How to Enable Express Path

NOTE: Express Path is automated from Junos OS Release 21.2R1.

To configure the Express Path mode:

- On an SRX5000 line device with IOC or flex IOC cards, use the `set chassis fpc fpc-number pic pic-number services-offload` command.
- On an SRX5000 line device with Modular Port Concentrator (MPC), enable NP cache on the IOC using the `set chassis fpc fpc-number np-cache` command.
- On SRX4600 device, the `np-cache` option is enabled by default. Hence, the `set chassis fpc fpc-number np-cache` command is not applicable.

If you do not use express path, do not configure it in any security policies.

Express Path Network Processor

IN THIS SECTION

- [Wing Statistics Counter | 259](#)
- [Sessions per Wing Statistics | 259](#)

On SRX4600, SRX5400, SRX5600, and SRX5800 devices with network processor, when all the plugins including packet plugins and stream plugins ignore a session, we service offload the session and then install the session on the network processor. When the packet plugin ignores the session, we mark the

ignore flags. When the streaming plugin ignores the session, we mark the ignore flags and short-circuit the TCP-T and TCP-I. We then install the session on the network processor to offload the session.

The I/O card (IOC) network processor processes the fast-path packets without going through the switch fabric or the SPU. This reduces the packet-processing latency.

Each flow entry has a per-wing counter in the Express Path network processor. The counter captures the number of bytes that the network processor sends out over the wing.

The behavior of the network processor in different scenarios is as follows:

- **First-path flow**—The first-path flow is the same as the current network processor flow process. When the first packet arrives at the network processor, the network processor parses the TCP or the UDP packet to extract a 5-tuple key and then performs session lookup in the flow table. The network processor then forwards the first packet to the central point. The central point cannot find a match at this time because this is the first packet. The central point and the SPU create a session and match it against user-configured policies to determine if the session is a normal session or a services-offload session.

If you specify the session to be managed with Express Path the SPU creates a session entry in the network processor flow table. This enables the Express Path flag in the session entry table; otherwise, the SPU creates a normal session entry in the network processor without the Express Path flag.

- **Fast-path flow**—After you create the session entry in the network processor, subsequent packets of the session will match the session entry table.
 1. If the Express Path flag is not set, then the network processor forwards the packet to the SPU specified in the session entry table. The packet goes through the normal flow process.
 2. If the network processor finds the services-offload flag in the session entry table, it will process the packet locally and send the packet out directly.
 3. The fast-forwarding function on the network processor supports one-fanout multicast sessions. The egress port in the session must also be associated with the same network processor as the ingress port. All other multicast cases need to be managed as normal sessions.
- **NAT process**—The SPU is responsible for mapping between the internal IP address or port and the external IP address or port. When the first packet of the session arrives, the SPU allocates the IP address or port mapping and stores the information in the network processor session entry. If the NAT flag is set, the network processor modifies the packet.
- **Session age-out**—To improve traffic throughput for services-offload sessions, a copy of a packet is sent to the SPU at every predefined time period to reduce the packet processing demand on the SPU. To limit the number of packet copies sent to the SPU, a timestamp is implemented for each service-offload session. The network processor calculates the elapsed time since the last session

match. If the elapsed time is greater than the predefined time period, then the network processor sends a copy of the packet to the SPU and updates the session timestamp.

- **Session termination and deletion**—If the network processor receives an IP packet with a FIN (finished data) or an RST (reset connection) flag, it forwards the packet to the SPU. The SPU then deletes the session cache on the network processor. The network processor continues to receive and forward any packets to the SPU during state transition.

Wing Statistics Counter

In Express Path, the network processor provides the option for each flow entry to keep a per-wing bytes counter. The counter captures the number of bytes that the network processor sends out over the wing.

When you enable the counter, the network processor searches its flow entry (a session wing) for every ingress packet. If the packet belongs to an established flow entry, the network processor increases the byte counter of the flow entry in the packet. The network processor periodically copies a packet (copy-packet) of each flow entry to its associated SPU, allowing the SPU to maintain the session. The network processor sends flow-byte counter values in the header of copy-packet packets. The SPU accumulates and keeps per-wing statistics counters.

You cannot change the statistics configuration during the life cycle of a live session. Disabling or enabling the per-wing statistics configuration while a session is alive at the network processor invalidates the session statistics on the current session. The new session statistics can be valid only after the configuration changes are committed. Network processor per-wing counters cannot be cleared. On SRX5800 devices with the SRX5K-MPC (IOC2), the SRX 5K-MPC3 (IOC3), and the SRX5K-IOC4-10G (IOC4) the wing statistics counter configuration is enabled, by default, On SRX4600 devices, enable the wing statistics counter.

Sessions per Wing Statistics

The network processor has a larger static RAM (SRAM) to accommodate session resources, thus hosting more sessions per PIC. [Table 16 on page 259](#) displays the total number of session wings, including both Express Path and non-Express Path. On SRX4600 devices, the IMIX throughput is 400Gbps.

Table 16: Total Number of Sessions per Wing in Network Processor Express Path Configuration Mode

Total Number of Wings		Number of Express Path UDP Wings		Number of Express Path TCP Wings	
Cards and SRX Series Firewall	Non-Express Path Mode Sessions	Without Statistics	With Statistics	Without Statistics	With Statistics

Table 16: Total Number of Sessions per Wing in Network Processor Express Path Configuration Mode (Continued)

Total Number of Wings		Number of Express Path UDP Wings		Number of Express Path TCP Wings	
SRX5000 line device SRX5K-MPC (IOC2)	1.8 million	1.8 million	1.8 million	1.8 million	1.8 million
SRX5000 line device SRX5K-MPC3 (IOC3)	20 million	20 million	20 million	20 million	20 million
SRX5000 line device SRX5K-IOC4	10 million	10 million	10 million	10 million	10 million
SRX4600	20 million	20 million	20 million	20 million	20 million

Express Path Packet Processing on IOC cards

Express Path on the IOC cards is based on processing fast-path packets through the network processor chipset instead of in the SPU to offload some basic firewall functions to the IOC card.

If you've enabled the Express Path feature, then the IOC card provides lower latency and also supports higher throughput by removing the overload on the SPU. The IOC card supports both intra-card traffic flow and inter-card traffic flow. To achieve the best latency results, both the ingress port and egress port of a traffic flow needs to be on the same XM chip of the IOC card.

The IOC card supports 240Gbps FPC and uses third generation Network Processing (NP) line of chipsets. This latest lookup and queuing chip is optimized for higher capacity. IOC card is compatible with SCB2 and SCB3, the earlier SCB is not supported.

You cannot power on all four PICs in the IOC card simultaneously because of power and thermal constrain. Power on a maximum of two PICs either in even or odd order. You can use the `set chassis fpc <slot> pic <pic> power off` command to choose the PIC to power on.

The system log messages are:

- XMCHIP_CMERROR_DDRIF_INT_REG_CHKSUM_ERR_MINOR
- XMCHIP_CMERROR_DDRIF_INT_REG_CHKSUM_ERR_MAJOR

The error messages indicate that the XM chip on a Flexible PIC Concentrator (FPC) has detected a checksum error, which is causing packet drops. The following error threshold values classify the error as a major error or a minor error:

- Minor error → 5 errors per second
- Major error → 255 errors per second (maximum count)

In the data plane, the IOC card parses packets and looks them up in the flow table. If the IOC card finds a match in the flow table, then it forwards packets based on the instructions given in the flow table. The IOC card can perform NAT, encapsulate the Layer 2 (L2) header, and forward the packets out of the egress interface. The egress interface can be located on the same IOC card (intra-card case) or another IOC card (inter-card case).

When the IOC card receives the first packet, it does not match any existing fast-forward session. The default hash-based forwarding is performed to send the first packet to the SPU. The SPU then creates the security session. If the SPU finds that the traffic is qualified for fast forwarding, and the related IOC card supports fast forwarding, it will install fast-forward session to the IOC card. If fast forwarding cannot be applied to the traffic, no session message is sent, and the IOC card uses the default hash-based forwarding to forward the packets to the SPU.

In fast-forward IOC card processing, if a fast-forward session is matched, the packet can be directly forwarded according to the session flow result. The IOC card takes all the necessary actions, for example, forwarding the packet, TTL checking and decreasing NAT translation, and Layer 2 header encapsulation.

In addition, the XL chip sends one copy of the forwarding packet to the SPU at a predefined time. This copy is used to refresh the SPU session, detect the current XL chip state, and so on. The SPU consumes this packet and does not forward it, because the real packet has been processed and transmitted.

Figure 33: IOC3 Intra-PFE Express Path

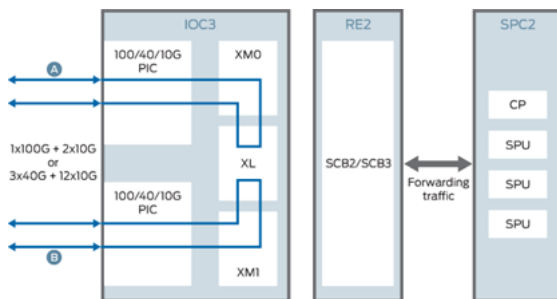

Figure 34: IOC3 Inter-PFE Express Path

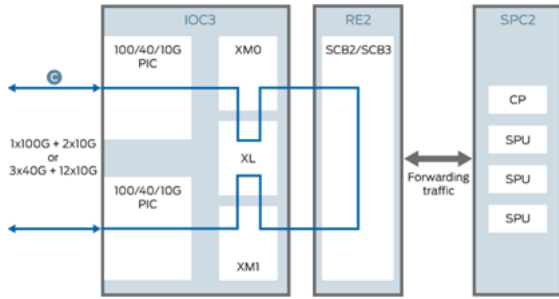
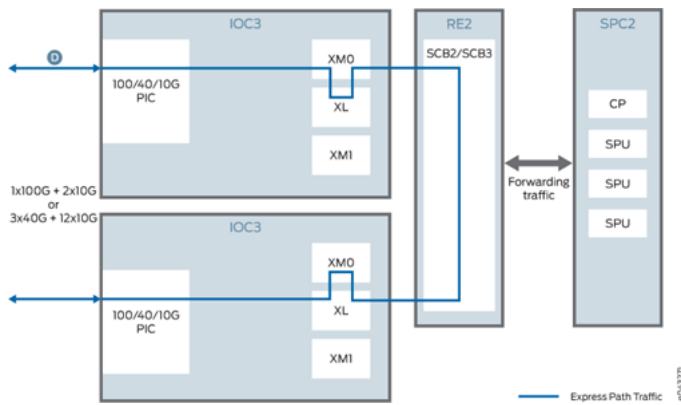

Figure 35: Inter-IOC3 Express Path



Example: Configure Express Path on SRX5400, SRX5600, or SRX5800 Device with an IOC card

This example shows how to configure Express Path on an IOC card on SRX5400, SRX5600, or SRX5800 device.

Express Path is a mechanism for processing fast-path packets in the network instead of in the Services Processing Unit (SPU). This method reduces the long packet-processing latency that arises when packets are forwarded from network processors to SPUs for processing and back to IOCs for transmission.

Starting in Junos OS Release 15.1X49-D40, the configuration is valid for IPv6 traffic, earlier to this release it was supported for IPv4 traffic only.

Requirements

This example uses the following hardware and software components:

- One SRX5400, SRX5600, or SRX5800 device with an IOC card

- Junos OS Release 15.1X49-D40 or later for SRX Series Firewalls

NOTE: Express Path is automated from Junos OS Release 21.2R1.

Overview

In this example, you configure Express Path on IOC card on an SRX5000 line device for IPv6 traffic.

You configure two interfaces on the IOC card and assign IPv6 addresses to them. Then you enable flow-based processing for IPv6 traffic. Next, you set up zones and add interfaces to them. Then you provide communication between the two different zones by configuring a security policy to allow traffic between two zones. You also enable Express Path in security policies to specify whether the traffic qualifies for Express Path

Configuration

Procedure

CLI Quick Configuration

To quickly configure this example, copy the following commands, paste them into a text file, remove any line breaks, change any details necessary to match your network configuration, copy and paste the commands into the CLI at the `[edit]` hierarchy level, and then enter `commit` from configuration mode.

```
[edit]
set interfaces et-2/1/0 unit 0 family inet6 address 2001:db8::4:12/32
set interfaces et-2/3/0 unit 0 family inet6 address 2001:db8::6:11/32
set security forwarding-options family inet mode flow-based
set security forwarding-options family inet6 mode flow-based
set zones security-zone zone-1 host-inbound-traffic system-services all
set zones security-zone zone-1 host-inbound-traffic protocols all
set zones security-zone zone-1 interfaces et-2/1/0.0
set zones security-zone zone-2 host-inbound-traffic system-services all
set zones security-zone zone-2 host-inbound-traffic protocols all
set zones security-zone zone-2 interfaces et-2/3/0.0
security policies from-zone zone-2 to-zone zone-1 policy express-path-policy-2 match source-
address any
security policies from-zone zone-2 to-zone zone-1 policy express-path-policy-2 match
destination- address any
security policies from-zone zone-2 to-zone zone-1 policy express-path-policy-2 match application
any
```

```

security policies from-zone zone-2 to-zone zone-1 policy express-path-policy-2 then permit then
permit services-offload
security policies from-zone zone-1 to-zone zone-2 policy express-path-policy-1 match source-
address any
security policies from-zone zone-1 to-zone zone-2 policy express-path-policy-1 match
destination- address any
security policies from-zone zone-1 to-zone zone-2 policy express-path-policy-1 match application
any
security policies from-zone zone-1 to-zone zone-2 policy express-path-policy-1 then permit then
permit services-offload
set chassis fpc 2 np-cache

```

Step-by-Step Procedure

To configure Express Path on SRX5400, SRX5600, or SRX5800 Line Device with an IOC card:

1. Configure the Ethernet interface and assign an IPv6 address to it.

```

[edit]
set interfaces et-2/1/0 unit 0 family inet6 address 2001:db8::4:12/32
set interfaces et-2/3/0 unit 0 family inet6 address 2001:db8::6:11/32

```

2. Enable flow-based processing for IPv6 traffic.

```

[edit]
set security forwarding-options family inet mode flow-based
set security forwarding-options family inet6 mode flow-based

```

3. Configure security zones, add interfaces, and allow all system services and interfaces. Configure a security zone and specify the types of traffic and protocols that are allowed on interface et-2/1/0.0.

```

[edit]
set zones security-zone zone-1 host-inbound-traffic system-services all
set zones security-zone zone-1 host-inbound-traffic protocols all
set zones security-zone zone-1 interfaces et-2/1/0.0

```

4. Configure security zones, add interfaces, and allow all system services and interfaces. Configure a security zone and specify the types of traffic and protocols that are allowed on interface et-2/3/0.0.

```
[edit]
set zones security-zone zone-2 host-inbound-traffic system-services all
set zones security-zone zone-2 host-inbound-traffic protocols all
set zones security-zone zone-2 interfaces et-2/3/0.0
```

5. Create a policy and specify the match criteria for that policy. The match criteria specify that the device can allow traffic from any source to any destination, and on any application. Enable Express Path in the security policy.

NOTE: You can specify the wildcard any-ipv6 for the source and destination address match criteria to include only IPv6 addresses. Specifying any option for the source and destination address match criteria to include both IPv4 and IPv6 addresses.

```
[edit]
security policies from-zone zone-2 to-zone zone-1 policy express-path-policy-2 match source-
address any
security policies from-zone zone-2 to-zone zone-1 policy express-path-policy-2 match
destination- address any
security policies from-zone zone-2 to-zone zone-1 policy express-path-policy-2 match
application any
security policies from-zone zone-2 to-zone zone-1 policy express-path-policy-2 then permit
then permit services-offload
```

```
[edit]
security policies from-zone zone-1 to-zone zone-2 policy express-path-policy-1 match source-
address any
security policies from-zone zone-1 to-zone zone-2 policy express-path-policy-1 match
destination- address any
security policies from-zone zone-1 to-zone zone-2 policy express-path-policy-1 match
application any
security policies from-zone zone-1 to-zone zone-2 policy express-path-policy-1 then permit
then permit services-offload
```

6. Set the Express Path mode on IOC card.

```
[edit]
set chassis fpc 2 np-cache
```

Results

From configuration mode, confirm your configuration by entering the show chassis command. If the output does not display the intended configuration, repeat the instructions in this example to correct the configuration.

```
from-zone zone-1 to-zone zone-2 { policy express-path-policy--1 {
match {
source-address any; destination-address any; application any;
}
then {
permit {
services-offload;
}
}
}
}
from-zone express-path-policy--2 { policy policy-2 {
match {
source-address any; destination-address any; application any;
}
then {
permit {
services-offload;
}
}
}
}
```

If you are done configuring the device, enter commit from configuration mode.

Verify the Configuration of an IOC card for Express Path

Purpose

Verify that the IOC card was configured properly for Express Path.

Action

From operational mode, enter the show chassis fpc pic-status command

```

Slot 1      Online   SRX5k SPC II
PIC  0      Online   SPU Cp
PIC  1      Online   SPU Flow
PIC  2      Online   SPU Flow
PIC  3      Online   SPU Flow
Slot 2      Online   SRX5k IOC3 2CGE+4XGE
PIC  0      Online   2x 10GE SFP+- np-cache/services-offload
PIC  1      Online   1x 100GE CFP2- np-cache/services-offload
PIC  2      Online   2x 10GE SFP+- np-cache/services-offload
PIC  3      Online   1x 100GE CFP2- np-cache/services-offload
Slot 3      Online   SRX5k IOC3 24XGE+6XLG
PIC  0      Offline  12x 10GE SFP+
PIC  1      Offline  12x 10GE SFP+
PIC  2      Online   3x 40GE QSFP+- np-cache/services-offload
PIC  3      Online   3x 40GE QSFP+- np-cache/services-offload
Slot 4      Offline  SRX5k IOC3 24XGE+6XLG

```

Meaning

The output provides the status of PICs with Express Path enabled on them.

Verifying All Active Sessions on the Device

Purpose

Display information about all currently active Express Path sessions on the device.

Action

From operational mode, enter the show security flow session services-offload command.

```
Flow Sessions on FPC1 PIC1:
```

```

Session ID: 50000002, Policy name: express-path-policy-2/5, Timeout: 60, Valid
In: 2001:db8::4:12/32 --> 2001:db8::6:11/32;udp, If: et-2/3/0.0, Conn ID: 0x0, Pkts: 181 29505,
Bytes: 1740432530, CP Session ID: 50000002
Out: 2001:db8::6:11/32 --> 2001:db8::4:12/32;udp, If: et-2/1/0.0, Conn ID: 0x0, Pkts: 18 129505,
Bytes: 1740432530, CP Session ID: 50000002
Total sessions: 1

```

Meaning

The output provides the policy details for sessions on which Express Path was enabled.



CHAPTER

Configuration Statements

aging | 272

all-tcp | 273

allow-dns-reply | 275

allow-embedded-icmp | 276

allow-reverse-ecmp | 278

application-services (Security Forwarding Process) | 279

apply-to-half-close-state | 282

cpu (resource-manager) | 283

destination-header | 285

destination-port (Security Forwarding Options) | 287

destination-prefix (Security Forwarding Options) | 293

early-ageout | 294

error | 295

fin-invalidate-session | 299

flow (Security Flow) | 302

force-ip-reassembly | 308

forwarding-process | 310

fpc error | 313

gre-in | 315

gre-out | 317

gre-performance-acceleration (Security Flow) | 319

high-watermark | 320

hop-by-hop-header | 322

icmpv6-malformed | 324

idle-timeout (System Services) | 325

inline-tap | 327

interface-in (Security Forwarding Options) | 329

interface-out (Security Forwarding Options) | 330

ipv4-template (Services) | 331

ipv6-extension-header | 333

ipv6-extension-header-limit | 335

ipv6-malformed-header | 337

ipv6-template (Services) | 338

low-latency | 340

low-watermark | 341

maximize-idp-sessions | 343

mirror-filter (Security Forwarding Options) | 345

mode (Security Forwarding Options) | 347

no-sequence-check | 350

np-cache (Flexible PIC Concentrator) | 351

output (Security Forwarding Options) | 353

packet-filter | 355

packet-log (Security Flow) | 357

packet-ordering-mode (Application Services) | 359

pending-sess-queue-length | 361

power-mode-disable | 362

pre-id-default-policy | 364

preserve-incoming-fragment-size | 367

propagate-settings | 369

protocol (Security Forwarding Options) | 370

resource-manager | 372

reverse-route-packet-mode-vr | 374

route-change-timeout | 375

rst-invalidate-session | 377

rst-sequence-check | 379

security-service (Security Forwarding Options) | 380

services-memory (resource-manager) | 382

session-memory (resource-manager) | 384

sampling | 386

services-offload | 388

session (System Services) | 390

session-limit (System Services) | 392

source-port (Security Forwarding Options) | 393

source-prefix (Security Forwarding Options) | 399

syn-flood-protection-mode | 400

tcp-initial-timeout | 402

tcp-mss (Security Flow) | 404

tcp-seq-ooo-window (Security Forwarding Options) | 406

tcp-session | 408

tcp-session-install-interval (Security Forwarding Options) | 410

time-wait-state | 411

traceoptions (Security) | 413

traceoptions (Security Flow) | 416

transport (Security Log) | 421

weight (Security) | 423

aging

IN THIS SECTION

- [Syntax | 272](#)
- [Hierarchy Level | 272](#)
- [Description | 272](#)
- [Options | 273](#)
- [Required Privilege Level | 273](#)
- [Release Information | 273](#)

Syntax

```
aging {  
    early-ageout seconds;  
    high-watermark percent;  
    low-watermark percent;  
}
```

Hierarchy Level

```
[edit security flow]
```

Description

The session aging mechanism accelerates the session time-out process when the percentage of entries in the session table exceeds the high-watermark setting, and then stops when the percentage of entries in the session table falls below the low-watermark setting.

Options

The remaining statements are explained separately. See the [CLI Explorer](#).

Required Privilege Level

security—To view this in the configuration.

security-control—To add this to the configuration.

Release Information

Statement introduced in Junos OS Release 8.5.

RELATED DOCUMENTATION

| [Understanding Traffic Processing on Security Devices | 2](#)

all-tcp

IN THIS SECTION

- [Syntax | 274](#)
- [Hierarchy Level | 274](#)
- [Description | 274](#)
- [Options | 274](#)
- [Required Privilege Level | 274](#)
- [Release Information | 274](#)

Syntax

```
all-tcp mss value;
```

Hierarchy Level

```
[edit security flow tcp-mss]
```

Description

Set the TCP maximum segment size (MSS) value to enable MSS override for all TCP packets in network traffic.

Options

mss value—TCP MSS value.

- **Range:** 64 through 65,535 bytes

Required Privilege Level

security—To view this in the configuration.

security-control—To add this to the configuration.

Release Information

Statement introduced in Junos OS Release 8.5.

RELATED DOCUMENTATION

[tcp-mss \(Security Flow\) | 404](#)

[Understanding Traffic Processing on Security Devices | 2](#)

allow-dns-reply

IN THIS SECTION

- [Syntax | 275](#)
- [Hierarchy Level | 275](#)
- [Description | 275](#)
- [Required Privilege Level | 276](#)
- [Release Information | 276](#)

Syntax

```
allow-dns-reply;
```

Hierarchy Level

```
[edit security flow]
```

Description

Allow an incoming Domain Name Service (DNS) reply packet without a matched request. By default, if an incoming UDP first-packet has dst-port 53, the device checks the DNS message packet header to verify that the query bit (QR) is 0, which denotes a query message. If the QR bit is 1, which denotes a

response message, the device drops the packet, does not create a session, and increments the illegal packet flow counter for the interface. Using the `allow-dns-reply` directs the device to skip the check.

Required Privilege Level

security—To view this in the configuration.

security-control—To add this to the configuration.

Release Information

Statement introduced in Junos OS Release 8.5.

RELATED DOCUMENTATION

[Understanding Traffic Processing on Security Devices | 2](#)

allow-embedded-icmp

IN THIS SECTION

- [Syntax | 277](#)
- [Hierarchy Level | 277](#)
- [Description | 277](#)
- [Required Privilege Level | 277](#)
- [Release Information | 277](#)

Syntax

```
allow-embedded-icmp;
```

Hierarchy Level

```
[edit security flow]
```

Description

Allow ICMP error packets to pass through the device even when there is no session match for the embedded packet. Once enabled, all packets encapsulated in ICMP pass through and no policy affects this behavior. This feature is useful when you have asymmetric routing in your network and you want to use traceroute and other ICMP applications on your device.

The default behavior is to inspect the IP packet which is embedded in the ICMP error packet. If the embedded packet is part of an existing session, the ICMP packet is allowed to pass through. If there is no match, it is dropped. Without the `allow-embedded-icmp` option configured, the default behavior applies.

Required Privilege Level

security—To view this in the configuration.

security-control—To add this to the configuration.

Release Information

Statement introduced in Junos OS Release 12.3X48-D10.

RELATED DOCUMENTATION

[Understanding Traffic Processing on Security Devices | 2](#)

allow-reverse-ecmp

IN THIS SECTION

- [Syntax | 278](#)
- [Hierarchy Level | 278](#)
- [Description | 278](#)
- [Required Privilege Level | 279](#)
- [Release Information | 279](#)

Syntax

```
allow-reverse-ecmp
```

Hierarchy Level

```
[edit security flow]
```

Description

Enable ECMP support for reverse traffic. In this case, Junos OS for SRX Series Firewalls and vSRX Virtual Firewall instances use a hash algorithm to determine the interface to use for reverse traffic in a flow. This process is similar to asymmetric routing in which a packet traverses from a source to a destination in one path and takes a different path when it returns to the source.

If you do not enable this feature, the software selects a route in the ECMP set to the incoming interface for reverse traffic, which is the default behavior.

Required Privilege Level

security—To view this in the configuration.

security-control—To add this to the configuration.

Release Information

Statement introduced in Junos OS Release 17.3.

RELATED DOCUMENTATION

[Understanding ECMP Flow-Based Forwarding | 72](#)

[Understanding ECMP Flow-Based Forwarding for Reverse Traffic on SRX Series Devices and vSRX Instances](#)

application-services (Security Forwarding Process)

IN THIS SECTION

- [Syntax | 280](#)
- [Hierarchy Level | 280](#)
- [Description | 280](#)
- [Options | 281](#)
- [Required Privilege Level | 281](#)
- [Release Information | 281](#)

Syntax

```
application-services {
  enable-gtpu-distribution;
  inline-fpga-crypto (disabled | enabled);
  maximize-alg-sessions;
  maximize-idp-sessions {
    weight (firewall | idp);
  }
  packet-ordering-mode (Application Services) {
    (hardware | software);
  }
}
```

Hierarchy Level

```
[edit security forwarding-process]
```

Description

You can configure SRX4100, SRX4200, SRX5400, SRX5600, and SRX5800 devices to switch from an integrated firewall mode to maximize Intrusion Detection and Prevention (IDP) mode to run IDP processing in tap mode and increase the capacity of processing with the `maximize-idp-sessions` option. Inline tap mode can only be configured if the forwarding process mode is set to `maximize-idp-sessions`, which ensures stability and resiliency for firewall services. You also do not need a separate tap or span port to use inline tap mode. When you maximize IDP, you are decoupling IDP processes from firewall processes, allowing the device to support the same number of firewall and IDP sessions, also run the IDP processing in tap mode.

You can configure maximum Application Layer Gateway (ALG) sessions by using the `maximize-alg-sessions` option. The session capacity number for Real-Time Streaming Protocol (RTSP), FTP, and Trivial File Transfer Protocol (TFTP) ALG varies per flow SPU. For SRX5000 line devices the session capacity is 10,240 per flow SPU. You must reboot the device (and its peer in chassis cluster mode) for the

configuration to take effect. The `maximize-alg-sessions` option now enables you to increase defaults as follows:

- TCP proxy connection capacity: 40,000 per flow SPU

Flow session capacity is reduced to half per flow SPU; therefore the aforementioned capacity numbers will not change on central point flow.

Enable GPRS tunneling protocol. GTP-U session distribution is a UE (User equipment) based distribution, generating tunnel based GTP-U session and distributing them across SPUs on a UE basis.

Before 15.1X49-D40, GTP-U sessions are distributed by GGSN IP address always.

15.1X49-D40 onward, the GTP-U distribution is disabled and fat GTP-U sessions are distributed as normal UDP.

Use the `enable-gtpu-distribution` command to enable GTP-U session distribution.

Use the `inline-fpga-crypto` (disabled | enabled) to enable or disable inline FPGA crypto

Options

The remaining statements are explained separately. See the [CLI Explorer](#).

Required Privilege Level

`security`—To view this in the configuration.

`security-control`—To add this to the configuration.

Release Information

Statement introduced in Junos OS Release 9.6. Statement updated in Junos OS Release 10.4. Statement updated in Junos OS Release 15.1X49-D40 with the `enable-gtpu-distribution` option. Statement updated in Junos OS Release 20.4R1 with the `inline-fpga-crypto` (disabled | enabled) option.

RELATED DOCUMENTATION

| [Understanding Traffic Processing on Security Devices](#) | 2

apply-to-half-close-state

IN THIS SECTION

- [Syntax](#) | 282
- [Hierarchy Level](#) | 282
- [Description](#) | 282
- [Required Privilege Level](#) | 283
- [Release Information](#) | 283

Syntax

```
apply-to-half-close-state;
```

Hierarchy Level

```
[edit security flow tcp-session time-wait-state]
```

Description

Configure the TCP session timeout in a half-closed state. This enables the system to apply the configured session timeout on receiving only one FIN packet (either client-to-server or server-to-client). When this is not configured, the default behavior takes effect—applying the configured TCP session timeout on receiving both the FIN packets. The default session timeout remains 150 seconds.

Required Privilege Level

security—To view this in the configuration.

security-control—To add this to the configuration.

Release Information

Statement introduced in Junos OS Release 12.1X46-D10.

RELATED DOCUMENTATION

[Understanding Traffic Processing on Security Devices | 2](#)

cpu (resource-manager)

IN THIS SECTION

- [Syntax | 283](#)
- [Hierarchy Level | 284](#)
- [Description | 284](#)
- [Options | 284](#)
- [Required Privilege Level | 285](#)
- [Release Information | 285](#)

Syntax

```
cpu {  
  disable-management;  
  match {
```

```

        threshold threshold;
    }
    then {
        alarm;
        drop-cps;
        drop-flows;
        log;
        max-session-setup-rate max-session-setup-rate;
    }
}

```

Hierarchy Level

[edit security resource-manager]

Description

Configure resource manager cpu options to control cpu load. Resource manager takes protective action when the traffic load reaches the threshold.

Options

- `disable-management`-Disables the cpu management. By default, cpu management is on.
- `match threshold`-Configure the threshold limit to let resource-manager take actions. The range is 1 to 100 percent.
- `drop-cps`-This is default action when the CPU usage crosses the default or configured threshold. This configuration drops the packets which do not have an existing associated session.
- `max-session-setup-rate`-This throttles new session creation to the specified rate when the cpu threshold is exceeded.
- `drop-flows`-When you mark a session as a drop-flow, it bypasses the first path for each new packet, which matches the original drop session for next 4 seconds only. This configuration drops the packets that match the drop-flows.

- `log`-This configuration logs messages when the resource threshold is exceeded and falls back under the threshold.
- `alarm`-This configuration sends an SNMP Trap when the CPU load exceeds the threshold.

Required Privilege Level

`security`—To view this in the configuration.

`security-control`—To add this to the configuration.

Release Information

Statement introduced in Junos OS Release 20.4R1.

RELATED DOCUMENTATION

| [Understanding Traffic Processing on Security Devices](#) | 2

destination-header

IN THIS SECTION

- [Syntax](#) | 286
- [Hierarchy Level](#) | 286
- [Description](#) | 286
- [Options](#) | 286
- [Required Privilege Level](#) | 287
- [Release Information](#) | 287

Syntax

```
destination-header {
    ILNP-nonce-option;
    home-address-option;
    line-identification-option;
    tunnel-encapsulation-limit-option;
    user-defined-option-type low | <to high>;
}
```

Hierarchy Level

```
[edit security screen ids-option screen-name ip ipv6-extension-header]
```

Description

Define the IPv6 destination header screen option.

Options

ILNP-nonce-option	Enable the Identifier-Locator Network Protocol nonce screen option.
home-address-option	Enable the home address screen option.
line-identification-option	Enable the line identification screen option.
tunnel-encapsulation-limit-option	Enable the tunnel encapsulation limit screen option.
user-defined-header-type <i>low</i> <to <i>high</i>>	Define the type of header range. <ul style="list-style-type: none"> • Range: 1 through 255.

Required Privilege Level

security—To view this in the configuration.

security-control—To add this to the configuration.

Release Information

Statement introduced in Junos OS Release 12.1X46-D10.

RELATED DOCUMENTATION

Understanding IPv6 Support for Screens

[ipv6-extension-header](#) | 333

[hop-by-hop-header](#) | 322

destination-port (Security Forwarding Options)

IN THIS SECTION

- [Syntax](#) | 287
- [Hierarchy Level](#) | 288
- [Description](#) | 288
- [Required Privilege Level](#) | 292
- [Release Information](#) | 292

Syntax

```
destination-port port-number;
```

Hierarchy Level

```
[edit security forwarding-options mirror-filter filter-name]
```

Description

Specify a Transmission Control Protocol (TCP) or User Datagram Protocol (UDP) destination port number to be matched for mirroring. You can specify a numeric value or one of the text synonyms listed in [Table 17 on page 288](#).

Table 17: Ports Supported by Services Interfaces

Port Name	Corresponding Port Number
afs	1483
bgp	179
biff	512
bootpc	68
bootps	67
cmd	514
cvspserver	2401
dhcp	67
domain	53
eklogin	2105

Table 17: Ports Supported by Services Interfaces (Continued)

Port Name	Corresponding Port Number
ekshell	2106
excc	512
finger	79
ftp	21
ftp-data	20
http	80
https	443
ident	113
imap	143
kerberos-sec	88
klogin	543
kpasswd	761
krb-prop	754
krbupdate	760
kshell	544

Table 17: Ports Supported by Services Interfaces (Continued)

Port Name	Corresponding Port Number
ldap	389
ldp	646
login	513
mobileip-agent	434
mobileip-mn	435
msdp	639
netbios-dgm	138
netbios-ns	137
netbios-ssn	139
nfsd	2049
nntp	119
ntalk	518
ntp	123
pop3	110
pptp	1723

Table 17: Ports Supported by Services Interfaces (Continued)

Port Name	Corresponding Port Number
printer	515
radacct	1813
radius	1812
rip	520
rkinit	2108
smtp	25
snmp	161
snmp-trap	162
snpp	444
socks	1080
ssh	22
sunrpc	111
syslog	514
tacacs	49
tacacs-ds	65

Table 17: Ports Supported by Services Interfaces (Continued)

Port Name	Corresponding Port Number
talk	517
telnet	23
tftp	69
timed	525
who	513
xdmcp	177

Required Privilege Level

security—To view this in the configuration.

security-control—To add this to the configuration.

Release Information

Statement introduced in Junos OS Release 12.1X46-D10.

RELATED DOCUMENTATION

[mirror-filter \(Security Forwarding Options\) | 345](#)

[show security forwarding-options mirror-filter | 819](#)

destination-prefix (Security Forwarding Options)

IN THIS SECTION

- [Syntax | 293](#)
- [Hierarchy Level | 293](#)
- [Description | 293](#)
- [Required Privilege Level | 293](#)
- [Release Information | 294](#)

Syntax

```
destination-prefix destination-prefix;
```

Hierarchy Level

```
[edit security forwarding-options mirror-filter filter-name]
```

Description

Specify the destination IP prefix or address to be matched for mirroring.

Required Privilege Level

security—To view this in the configuration.

security-control—To add this to the configuration.

Release Information

Statement introduced in Junos OS Release 12.1X46-D10.

RELATED DOCUMENTATION

[mirror-filter \(Security Forwarding Options\) | 345](#)

[show security forwarding-options mirror-filter | 819](#)

early-ageout

IN THIS SECTION

- [Syntax | 294](#)
- [Hierarchy Level | 294](#)
- [Description | 295](#)
- [Options | 295](#)
- [Required Privilege Level | 295](#)
- [Release Information | 295](#)

Syntax

```
early-ageout seconds;
```

Hierarchy Level

```
[edit security flow aging]
```

Description

Define the value before the device aggressively ages out a session from its session table.

Options

seconds —Amount of time that elapses before the device aggressively ages out a session.

- **Range:** 1 through 65,535 seconds
- **Default:** 20 seconds

Required Privilege Level

security—To view this in the configuration.

security-control—To add this to the configuration.

Release Information

Statement introduced in Junos OS Release 8.5.

RELATED DOCUMENTATION

| [Understanding Traffic Processing on Security Devices | 2](#)

error

IN THIS SECTION

● [Syntax | 296](#)

- [Hierarchy Level | 296](#)
- [Description | 296](#)
- [Options | 297](#)
- [Required Privilege Level | 299](#)
- [Release Information | 299](#)

Syntax

```
error {  
    (fatal | major | minor) {  
        threshold threshold number;  
        action (alarm | disable-pfe | offline-pic | log | get-state |offline | reset);  
    }  
}
```

Hierarchy Level

[edit chassis]

[edit chassis fpc slot-number]

Description

Configure the threshold at which FPC errors will take the action you configure to be performed by the device.

Some devices include an internal framework for detecting and correcting FPC errors that can have the potential to affect services. You can classify FPC errors according to severity, set an automatic recovery action for each severity, and set a threshold (the number of times the error must occur before the action is triggered).

However, the alarm is added to the default fault handling action list for a fatal error. Adding an alarm to the default fault handling list will allow the chassis alarm to trigger the RG1 switchover as soon as the fatal error is detected.

Starting with Junos OS Release 15.1-X49-D50 and Junos OS Release 17.3R1, this feature supports I/O cards (IOCs) and Services Processing Cards (SPCs) on the Junos OS SRX5000 line of devices. The following cards are supported:

- IOC2
- IOC3
- SPC2



CAUTION: Take care when setting the fault handling actions for SPC2 cards on the SRX5000 line of devices. Consider that if you set the fault handling action on an SPC2 card to offline or reset, when the card is either taken offline or the reboot occurs, the chassis daemon (chassisd) will reboot all of its FPC cards, both SPCs and IOCs—that is, the entire chassis will be rebooted.

Options

You can configure the threshold for the following severity levels:

NOTE: You cannot change the severity level of an error.

- `fatal`—Fatal error on the FPC. An error that results in the blockage of a considerable amount of traffic across modules is a fatal error. (default: raise an alarm and reset the FPC)
- `major`—Major error on the FPC. An error that results in continuing loss of packet traffic but does not affect other modules is a major error. (default: get the current state of the FPC and raise an alarm)
- `minor`—Minor error on the FPC. An error that results in the loss of a small number of packets but is fully recoverable is a minor error. (default: write a log for the event.)
- `threshold threshold-value`—Configure the threshold value at which to take action. If the severity level of the error is fatal, the action is carried out only once when the total number of errors exceeds the threshold value. If the severity level of the error is major, the action is carried out once after the occurrence exceeds the threshold. If the severity level is minor, the action is carried out as many times as the value specified by the threshold. For example, when the severity level is minor, and you have configured the threshold value as 10, the action is carried out after the tenth occurrence.

NOTE: You can set the threshold value to 0 for errors with a severity level of minor. This implies that no action is taken for that error. You cannot set the threshold value to 0 for errors with a severity level of major or fatal.

Reset and offline are not listed as default actions for the minor error level for safety purposes.

The alarm and reset default action is included in the implementation for the SRX5000 line of devices. It is required to trigger the RG1 switchover in a chassis cluster environment when an FPC fatal error occurs and the alarm being raised is a major alarm.

Default: The error count for fatal and major actions is 1. The default error count for minor actions is 10.

[Table 18 on page 298](#) shows the range of values for each error level.

Table 18: Value Ranges for Error Levels

Error Level	Default Threshold	Value Range
Fatal	1	1 through 1024
Major	1	1 through 1024
Minor	10	0 through 1024

The available detection and recovery actions are as follows:

- `alarm`—Raise an alarm.
- `disable-pfe`—Disable the Packet Forwarding Engine interfaces on the FPC.
- `get-state`—Get the current state of the FPC.
- `log`—Generate a log for the event.
- `offline`—Take the FPC offline.
- `offline-pic`—Take the PIC (installed in the FPC) offline.
- `reset`—Reset the FPC.

Required Privilege Level

<code>interface</code>	To view this in the configuration.
<code>interface-control</code>	To add this to the configuration.

Release Information

Statement introduced in Junos OS Release 15.1X49-D40.

RELATED DOCUMENTATION

[fpc error | 313](#)

fin-invalidate-session

IN THIS SECTION

- [Syntax | 299](#)
- [Hierarchy Level | 300](#)
- [Description | 300](#)
- [Required Privilege Level | 301](#)
- [Release Information | 302](#)

Syntax

```
fin-invalidate-session;
```

Hierarchy Level

[edit security flow tcp-session]

Description

Invalidates a TCP session after the 4-way or 3-way handshake completes, with each session endpoint signalling conclusion of the session independently. New incoming SYN packets will need to establish a new TCP session.

When either session endpoint wants to terminate the session, it sends a FIN(ish) message. When the other session endpoint receives the packet with the FIN flag set, it sends an ACK(nowledge) message. Typically, tearing down a session involves transmission of a pair of FIN-ACK messages from each session endpoint.

After the side that sent the first FIN responds with the final ACK, it waits for a time-out period to expire before closing the connection. During the time-out period, the local port cannot be used for new connections. The time-out period protects against delayed packets from the terminating session being delivered during subsequent connections.

NOTE: On SRX Series Firewalls with `fin-invalidate-session` configured the invalidation of the session occurs immediately whereas without `fin-invalidate-session` configured the session is set to time out 2 seconds after the 4-way or 3-way handshake completes.

Table 19 on page 300 shows the sequence of packets for a 4-way handshake to terminate a session. In this case, the client signals the server that it is terminating the session. The server responds with an ACK message signaling acknowledgement of the client's FIN message. The ACK is followed immediately by a FIN message that the server sends to the client, signaling that it is terminating the session connection on its end. Finally, the client sends an ACK message to the server signalling that it received the server's FIN message.

Table 19: Terminating a Session with a 4-Way Handshake

Step	Client	Server
1.	FIN	

2.		ACK
3.		FIN <ul style="list-style-type: none"> • Sets session timer to 150 seconds.
4.	ACK <ul style="list-style-type: none"> • Sets session timer to 2 seconds. 	

A session can be terminated by a 3-way handshake. In this case, the client sends a FIN message to the server. The server responds with message that combines the FIN and ACK messages. The sequence of packet exchange for a three-way handshake session close is as follows:

Step	Client	Server
1.	FIN	
2.		FIN/ ACK <ul style="list-style-type: none"> • sets session timer to 150 seconds
3.	ACK <ul style="list-style-type: none"> • sets session timer to 2 seconds 	

Required Privilege Level

security—To view this in the configuration.

security-control—To add this to the configuration.

Release Information

Statement introduced in Junos OS Release 10.4 R13.

RELATED DOCUMENTATION

[Understanding Traffic Processing on Security Devices](#) | 2

flow (Security Flow)

IN THIS SECTION

- [Syntax](#) | 302
- [Hierarchy Level](#) | 306
- [Description](#) | 306
- [Options](#) | 306
- [Required Privilege Level](#) | 308
- [Release Information](#) | 308

Syntax

```
flow {
  advanced-options {
    drop-matching-link-local-address;
    drop-matching-reserved-ip-address;
    reverse-route-packet-mode-vr;
  }
  aging {
    early-ageout seconds;
    high-watermark percent;
    low-watermark percent;
  }
}
```

```

allow-dns-reply;
allow-embedded-icmp;
Configuring Access Lists for SNMP Access over Routing Instances;
enable-reroute-uniform-link-check {
    nat;
}
enhanced-routing-mode;
ethernet-switching {
    block-non-ip-all;
    bpdu-vlan-flooding;
    bypass-non-ip-unicast;
    no-packet-flooding {
        no-trace-route;
    }
}
force-ip-reassembly;
gre-performance-acceleration;
ipsec-performance-acceleration (Security Flow);
load-distribution {
    session-affinity {
        ipsec;
    }
}
mcast-buffer-enhance;
multicast-nh-resolve-retry multicast-nh-resolve-retry-value;
no-local-favor-ecmp;
packet-log (Security Flow) {
    enable;
    packet-filter name {
        conn-tag conn-tag;
        destination-port (afs | bgp | biff | bootpc | bootps | cmd | cvspserver | dhcp |
domain | eklogin | ekshell | exec | finger | ftp | ftp-data | http | https | ident | imap |
kerberos-sec | klogin | kpasswd | krb-prop | krbupdate | kshell | ldap | ldap | login | mobileip-
agent | mobilip-mn | msdp | netbios-dgm | netbios-ns | netbios-ssn | nfsd | nntp | ntalk | ntp |
pop3 | pptp | printer | radacct | radius | range | rip | rkinit | smtp | snmp | snmptrap | snpp
| socks | ssh | sunrpc | syslog | tacacs | tacacs-ds | talk | telnet | tftp | timed | who |
xdmcp | zephyr-clt | zephyr-hm | zephyr-srv);
        destination-prefix destination-prefix;
        interface interface;
        logical-system logical-system;
        protocol (ah | egp | esp | gre | icmp | icmp6 | igmp | ipip | number | ospf | pim |
rsvp | sctp | tcp | udp);
        source-port (afs | bgp | biff | bootpc | bootps | cmd | cvspserver | dhcp | domain |

```

```

eklogin | ekshell | exec | finger | ftp | ftp-data | http | https | ident | imap | kerberos-sec
| klogin | kpasswd | krb-prop | krbupdate | kshell | ldap | ldp | login | mobileip-agent |
mobilip-mn | msdp | netbios-dgm | netbios-ns | netbios-ssn | nfsd | nntp | ntalk | ntp | pop3 |
pptp | printer | radacct | radius | range | rip | rkinit | smtp | snmp | snmptrap | snpp | socks
| ssh | sunrpc | syslog | tacacs | tacacs-ds | talk | telnet | tftp | timed | who | xdmcp |
zephyr-clt | zephyr-hm | zephyr-srv);
    source-prefix source-prefix;
}
    throttle-interval milliseconds;
}
pending-sess-queue-length (high | moderate | normal);
power-mode-ipsec;
preserve-incoming-fragment-size;
route-change-timeout seconds;
strict-packet-order;
syn-flood-protection-mode (syn-cookie | syn-proxy);
sync-icmp-session;
tcp-mss (Security Flow) {
    all-tcp {
        mss mss;
    }
    gre-in {
        mss mss;
    }
    gre-out {
        mss mss;
    }
    ipsec-vpn (Security Flow) {
        mss mss;
    }
}
tcp-session {
    fin-invalidate-session;
    maximum-window (128K | 1M | 256K | 512K | 64K);
    no-sequence-check;
    no-syn-check;
    no-syn-check-in-tunnel;
    rst-invalidate-session;
    rst-sequence-check;
    strict-syn-check;
    tcp-initial-timeout seconds;
    time-wait-state {
        (session-ageout | session-timeout seconds);
    }
}

```



```

        apply-to-half-close-state;
    }
}
traceoptions (Security Flow) {
    file <filename> <files files> <match match> <size size> <(world-readable | no-world-
readable)>;
    flag name;
    no-remote-trace;
    packet-filter name {
        conn-tag conn-tag;
        destination-port (afs | bgp | biff | bootpc | bootps | cmd | cvspserver | dhcp |
domain | eklogin | ekshell | exec | finger | ftp | ftp-data | http | https | ident | imap |
kerberos-sec | klogin | kpasswd | krb-prop | krbupdate | kshell | ldap | ldp | login | mobileip-
agent | mobilip-mn | msdp | netbios-dgm | netbios-ns | netbios-ssn | nfsd | nntp | ntalk | ntp |
pop3 | pptp | printer | radacct | radius | range | rip | rkinit | smtp | snmp | snmptrap | snpp
| socks | ssh | sunrpc | syslog | tacacs | tacacs-ds | talk | telnet | tftp | timed | who |
xdmcp | zephyr-clt | zephyr-hm | zephyr-srv);
        destination-prefix destination-prefix;
        interface interface;
        logical-system logical-system;
        protocol (ah | egp | esp | gre | icmp | icmp6 | igmp | ipip | number | ospf | pim |
rsvp | sctp | tcp | udp);
        source-port (afs | bgp | biff | bootpc | bootps | cmd | cvspserver | dhcp | domain |
eklogin | ekshell | exec | finger | ftp | ftp-data | http | https | ident | imap | kerberos-sec
| klogin | kpasswd | krb-prop | krbupdate | kshell | ldap | ldp | login | mobileip-agent |
mobilip-mn | msdp | netbios-dgm | netbios-ns | netbios-ssn | nfsd | nntp | ntalk | ntp | pop3 |
pptp | printer | radacct | radius | range | rip | rkinit | smtp | snmp | snmptrap | snpp | socks
| ssh | sunrpc | syslog | tacacs | tacacs-ds | talk | telnet | tftp | timed | who | xdmcp |
zephyr-clt | zephyr-hm | zephyr-srv);
        source-prefix source-prefix;
    }
    rate-limit rate-limit;
    trace-level {
        (brief | detail | error);
    }
}
}
}

```

Hierarchy Level

[edit security]

Description

Determine how the device manages packet flow. The device can regulate packet flow in the following ways:

Options

advanced-options	Flow configuration advanced options. <ul style="list-style-type: none"> • Values: <ul style="list-style-type: none"> • drop-matching-link-local-address—Drop matching link local address. • drop-matching-reserved-ip-address—Drop matching reserved source IP address. • reverse-route-packet-mode-vr—Allow reverse route lookup with packet mode vr.
allow-dns-reply	Allow unmatched incoming DNS reply packet.
allow-embedded-icmp	Allow embedded ICMP packets not matching a session to pass through.
allow-reverse-ecmp	Allow reverse ECMP route lookup.
enable-reroute-uniform-link-check	Enable reroute check with uniform link. <ul style="list-style-type: none"> • Values: <ul style="list-style-type: none"> • nat—Enable NAT check.
enhanced-routing-mode	Enable enhanced route scaling.
force-ip-reassembly	Force to reassemble IP fragments.

gre-performance-acceleration	Accelerate the GRE traffic performance.
ipsec-performance-acceleration	Accelerate the IPSec traffic performance.
mcast-buffer-enhance	Allow to hold more packets during multicast session creation.
multicast-nh-resolve-retry	<p>You can use this command configure the multicast route next-hop resolve attempts. When a multicast route next-hop resolve is unsuccessful, the SRX Series Firewall attempts to resolve the next-hop route based on the specified retry counts.</p> <ul style="list-style-type: none"> • Default: 0 • Range: 0 through 20
no-local-favor-ecmp	Does not prefer local node in HA ECMP route lookup.
pending-sess-queue-length	<p>Maximum queued length per pending session.</p> <ul style="list-style-type: none"> • Values: <ul style="list-style-type: none"> • high—Maximum number of queued sessions. • moderate—Allow more queued sessions than normal. • normal—Normal number of sessions queued.
power-mode-ipsec	Enable power mode ipsec processing.
preserve-incoming-fragment-size	Preserve incoming fragment size for egress MTU.
route-change-timeout	<p>Timeout value for route change to nonexistent route (seconds).</p> <ul style="list-style-type: none"> • Default: 6 • Range: 6 through 1800
strict-packet-order	You can use this command to maintain multicast traffic order and resolve packet drop issue.
syn-flood-protection-mode	<p>TCP SYN flood protection mode.</p> <ul style="list-style-type: none"> • Values: <ul style="list-style-type: none"> • syn-cookie—Enable SYN cookie protection. • syn-proxy—Enable SYN proxy protection.

sync-icmp-session Allow icmp sessions to sync to peer node.

Required Privilege Level

security—To view this statement in the configuration.

security-control—To add this statement to the configuration.

Release Information

Statement modified in Junos OS Release 9.5. The `power-mode-ipsec` option added in Junos OS Release 18.3R1 for vSRX Virtual Firewall instances, in Junos OS Release 18.4R1 for SRX4100 and SRX4200 devices, and in Junos OS Release 18.2R2 for SRX5400, SRX5600, and SRX5800 devices. The `multicast-nh-resolve-retry` and the `strict-packet-order` options are added in Junos OS Release 20.2R2 for SRX345 and SRX1500 devices. The `gre-performance-acceleration` option added in Junos OS Release 21.1R1.

RELATED DOCUMENTATION

[Understanding Traffic Processing on Security Devices](#)

[Understanding Session Characteristics for SRX Series Services Gateways](#)

[Understanding Packet Flow in Logical Systems for SRX Series Devices](#)

force-ip-reassembly

IN THIS SECTION

- [Syntax | 309](#)
- [Hierarchy Level | 309](#)
- [Description | 309](#)
- [Required Privilege Level | 309](#)

Syntax

```
force-ip-reassembly;
```

Hierarchy Level

```
[edit security flow]
```

Description

Reassemble all IP fragmented packets before forwarding.

This option is disabled by default. You can disable this option by deleting this flag from the CLI.

Force reassembly happens when all the fragment packets are received, and the session has been created (first path) or session has been matched (fast path) in the session SPU when you configure `force-ip-reassembly` command.

Required Privilege Level

security—To view this in the configuration.

security-control—To add this to the configuration.

Release Information

Statement introduced in Junos OS Release 11.2.

RELATED DOCUMENTATION

[Understanding Traffic Processing on Security Devices](#) | 2

forwarding-process

IN THIS SECTION

- [Syntax](#) | 310
- [Hierarchy Level](#) | 311
- [Description](#) | 311
- [Options](#) | 312
- [Required Privilege Level](#) | 312
- [Release Information](#) | 312

Syntax

```
forwarding-process {  
    application-services (Security Forwarding Process) {  
        enable-gtpu-distribution;  
        inline-fpga-crypto (disabled | enabled);  
        maximize-alg-sessions;  
        maximize-idp-sessions {  
            inline-tap;  
            weight (Security) {  
                firewall;  
                idp {  
                }  
            }  
        }  
    }  
}
```

```

    }
  }
  maximize-persistent-nat-capacity;
  packet-ordering-mode (hardware | software);
}
enhanced-services-mode;
}

```

Hierarchy Level

```
[edit security]
```

Description

You can configure SRX5400, SRX5600, and SRX5800 devices to switch from an integrated firewall mode to maximize Intrusion Detection and Prevention (IDP) mode to run IDP processing in tap mode and increase the capacity of processing with the `maximize-idp-sessions` option. Inline tap mode can only be configured if the forwarding process mode is set to `maximize-idp-sessions`, which ensures stability and resiliency for firewall services. You also do not need a separate tap or span port to use inline tap mode. When you maximize IDP, you are decoupling IDP processes from firewall processes, allowing the device to support the same number of firewall and IDP sessions, also run the IDP processing in tap mode.

You can configure maximum Application Layer Gateway (ALG) sessions by using the `maximize-alg-sessions` option. By default, the session capacity number for Real-Time Streaming Protocol (RTSP), FTP, and Trivial File Transfer Protocol (TFTP) ALG sessions is 10,000 per flow Services Processing Unit (SPU). You must reboot the device (and its peer in chassis cluster mode) for the configuration to take effect. The `maximize-alg-sessions` option now enables you to increase defaults as follows:

- RTSP, FTP, and TFTP ALG session capacity: 25,000 per flow SPU
- TCP proxy connection capacity: 40,000 per flow SPU

NOTE: Flow session capacity is reduced to half per flow SPU; therefore the aforementioned capacity numbers will not change on central point flow.

Enable GPRS tunneling protocol, user plane(GTP-U) session distribution to distribute GTP-U traffic handled by a Gateway GPRS Support Node (GGSN) and a Serving GPRS Support Node (SGSN) pair on all Services Processing Units (SPUs). You can configure tunnel-base distribution to distribute GTP-U traffic to multiple SPUs by the `enable-gtpu-distribution` option on SRX5400, SRX5600, and SRX5800 devices , which helps to resolve the GTP-U fat session issue. Also, `enable-gtpu-distribution` command is must for enabling stateful GTP-U inspection.

Options

`enhanced-services-mode`

Enable enhanced application services mode.

When Enhanced Service Mode is enabled, resources such as MBUF, JBUF, SERVICE-MEM, TCP-PROXY TCB, SZ-INFO and user heap are increased in size and Layer 4 session numbers are reduced by half.

The remaining statements are explained separately. See the [CLI Explorer](#).

Required Privilege Level

`security`—To view this in the configuration.

`security-control`—To add this to the configuration.

Release Information

Statement introduced in Junos OS Release 9.6. This statement is supported.

Option `enhanced-services-mode` introduced in Junos OS Release 20.3R1 on vSRX Virtual Firewall 3.0.

RELATED DOCUMENTATION

[application-services \(Security Forwarding Process\) | 279](#)

[Understanding Traffic Processing on Security Devices | 2](#)

fpc error

IN THIS SECTION

- [Syntax | 313](#)
- [Hierarchy Level | 313](#)
- [Description | 314](#)
- [Options | 314](#)
- [Required Privilege Level | 315](#)
- [Release Information | 315](#)

Syntax

```
fpc slot number {  
  error {  
    (fatal | major | minor) {  
      threshold threshold-value;  
      action (alarm | disable-pfe | offline-pic | log | get-state |offline | reset);  
    }  
  }  
}
```

Hierarchy Level

[edit chassis]

Description

Configure the threshold at which FPC errors will take the action you configure to be performed by the device.

Some devices include an internal framework for detecting and correcting FPC errors that can have the potential to affect services. For each FPC on the device, you can classify errors according to severity, set an automatic recovery action for each severity, and set a threshold (the number of times the error must occur before the action is triggered).

Options

- `fatal`—Fatal error on the FPC. An error that results in the blockage of a considerable amount of traffic across modules is a fatal error.
- `major`—Major error on the FPC. An error that results in continuing loss of packet traffic but does not affect other modules is a major error.
- `minor`—Minor error on the FPC. An error that results in the loss of a small number of packets but is fully recoverable is a minor error.
- `threshold threshold-value`—Configure the threshold value at which to take action. If the severity level of the error is fatal, the action is carried out only once when the total number of errors exceeds the threshold value. If the severity level of the error is major, the action is carried out once after the occurrence exceeds the threshold. If the severity level is minor, the action is carried out as many times as the value specified by the threshold. For example, when the severity level is minor, and you have configured the threshold value as 10, the action is carried out after the tenth occurrence.

NOTE: You can set the threshold value to 0 for errors with a severity level of minor. This implies that no action is taken for that error. You cannot set the threshold value to 0 for errors with a severity level of major or fatal.

Default: The error count for fatal and major actions is 1. The default error count for minor actions is 10.

Range: 0–429,496,729

The available detection and recovery actions are as follows:

- `alarm`—Raise an alarm.

- `disable-pfe`—Disable the Packet Forwarding Engine interfaces on the FPC.
- `get-state`—Get the current state of the FPC.
- `log`—Generate a log for the event.
- `offline`—Take the FPC offline.
- `offline-pic`—Take the PIC (installed in the FPC) offline.
- `reset`—Reset the FPC.

Required Privilege Level

`routing`—To view this in the configuration.

`routing-control`—To add this to the configuration.

Release Information

Statement introduced in Junos OS Release 15.1X49-D40. This command is supported.

RELATED DOCUMENTATION

| [error](#) | [295](#)

gre-in

IN THIS SECTION

- [Syntax](#) | [316](#)
- [Hierarchy Level](#) | [316](#)
- [Description](#) | [316](#)

- Options | 316
- Required Privilege Level | 317
- Release Information | 317

Syntax

```
gre-in {  
    mss value;  
}
```

Hierarchy Level

```
[edit security flow tcp-mss]
```

Description

Enable and specify the TCP maximum segment size (TCP MSS) for Generic Routing Encapsulation (GRE) packets that are coming out from an IPsec VPN tunnel. If the device receives a GRE-encapsulated TCP packet with the SYN bit and TCP MSS option set and the TCP MSS option specified in the packet exceeds the TCP MSS specified by the device, the device modifies the TCP MSS value accordingly. By default, a TCP MSS for GRE packets is not set.

Options

`mss value`—TCP MSS for GRE packets. Value is optional.

- **Range:** 64 through 63535 bytes
- **Default:** 1320 bytes, if no value is specified

Required Privilege Level

security—To view this in the configuration.

security-control—To add this to the configuration.

Release Information

Statement introduced in Junos OS Release 8.5.

RELATED DOCUMENTATION

[Understanding Traffic Processing on Security Devices | 2](#)

gre-out

IN THIS SECTION

- [Syntax | 318](#)
- [Hierarchy Level | 318](#)
- [Description | 318](#)
- [Options | 318](#)
- [Required Privilege Level | 318](#)
- [Release Information | 319](#)

Syntax

```
gre-out {  
    mss value;  
}
```

Hierarchy Level

```
[edit security flow tcp-mss]
```

Description

Enable and specify the TCP maximum segment size (TCP MSS) for Generic Routing Encapsulation (GRE) packets that are going into an IPsec VPN tunnel. If the device receives a GRE-encapsulated TCP packet with the SYN bit and TCP MSS option set and the TCP MSS option specified in the packet exceeds the TCP MSS specified by the device, the device modifies the TCP MSS value accordingly. By default, a TCP MSS for GRE packets is not set.

Options

`mss value`—TCP MSS for GRE packets. Value is optional.

- **Range:** 64 through 65,535 bytes
- **Default:** 1320 bytes

Required Privilege Level

`security`—To view this in the configuration.

`security-control`—To add this to the configuration.

Release Information

Statement introduced in Junos OS Release 8.5.

RELATED DOCUMENTATION

[Understanding Traffic Processing on Security Devices](#) | 2

gre-performance-acceleration (Security Flow)

IN THIS SECTION

- [Syntax](#) | 319
- [Hierarchy Level](#) | 319
- [Description](#) | 320
- [Required Privilege Level](#) | 320
- [Release Information](#) | 320

Syntax

```
gre-performance-acceleration;
```

Hierarchy Level

```
[edit security flow]
```

Description

Enables GRE performance acceleration. This helps to accelerate GRE traffic performance.

Required Privilege Level

security—To view this statement in the configuration.

security-control—To add this statement to the configuration.

Release Information

Statement introduced in Junos OS Release 21.1R1 for SRX Series and NFX Series.

RELATED DOCUMENTATION

| [show security flow status](#) | 808

high-watermark

IN THIS SECTION

- [Syntax](#) | 321
- [Hierarchy Level](#) | 321
- [Description](#) | 321
- [Options](#) | 321
- [Required Privilege Level](#) | 321
- [Release Information](#) | 321

Syntax

```
high-watermark percent;
```

Hierarchy Level

```
[edit security flow aging]
```

Description

Sets the point at which the aggressive aging-out process begins.

Options

percent —Percentage of session-table capacity at which aggressive aging-out starts.

- **Range:** 1 through 100 percent
- **Default:** 100 percent

Required Privilege Level

security—To view this in the configuration.

security-control—To add this to the configuration.

Release Information

Statement introduced in Junos OS Release 8.5.

RELATED DOCUMENTATION

[Understanding Traffic Processing on Security Devices | 2](#)

hop-by-hop-header

IN THIS SECTION

- [Syntax | 322](#)
- [Hierarchy Level | 322](#)
- [Description | 323](#)
- [Options | 323](#)
- [Required Privilege Level | 323](#)
- [Release Information | 323](#)

Syntax

```
hop-by-hop-header {  
    CALIPSO-option;  
    RPL-option;  
    SFM-DPD-option;  
    jumbo-payload-option;  
    quick-start-option;  
    router-alert-option;  
    user-defined-option-type low | <to high>;  
}
```

Hierarchy Level

```
[edit security screen ids-option screen-name ip ipv6-extension-header]
```

Description

Define the IPv6 hop-by-hop screen option.

Options

CALIPSO-option	Enable the Common Architecture Label IPv6 Security Option.
RPL-option	Enable the Routing Protocol for Low-Power and Lossy Networks screen option.
SMF-DPD-option	Enable the Simplified Multicast Forwarding IPv6 Duplicate Packet Detection screen option.
jumbo-payload-option	Enable the IPv6 jumbo payload screen option.
quick-start-option	Enable the IPv6 quick start screen option.
router-alert-option	Enable the IPv6 router alert screen option.
user-defined-header-type <i>low</i> <to <i>high</i>>	Define the type of header range. <ul style="list-style-type: none"> • Range: 1 through 255.

Required Privilege Level

security—To view this in the configuration.

security-control—To add this to the configuration.

Release Information

Statement introduced in Junos OS Release 12.1X46-D10.

RELATED DOCUMENTATION

Understanding IPv6 Support for Screens

[ipv6-extension-header](#) | 333

[destination-header](#) | 285

icmpv6-malformed

IN THIS SECTION

- [Syntax](#) | 324
- [Hierarchy Level](#) | 324
- [Description](#) | 325
- [Options](#) | 325
- [Required Privilege Level](#) | 325
- [Release Information](#) | 325

Syntax

```
icmpv6-malformed;
```

Hierarchy Level

```
[edit security screen ids-option screen-name icmp]
```

Description

Enable the ICMPv6 malformed intrusion detection service (IDS) option.

Options

This has no options.

Required Privilege Level

security—To view this in the configuration.

security-control—To add this to the configuration.

Release Information

Statement introduced in Junos OS Release 12.1X46-D10.

RELATED DOCUMENTATION

Understanding IPv6 Support for Screens

[ipv6-extension-header](#) | 333

idle-timeout (System Services)

IN THIS SECTION

- [Syntax](#) | 326
- [Hierarchy Level](#) | 326

- Description | 326
- Options | 326
- Required Privilege Level | 327
- Release Information | 327

Syntax

```
idle-timeout;
```

Hierarchy Level

```
[edit system services web-management session]
```

Description

Configure in minutes the idle-timeout parameter for web-management sessions. The idle-timeout parameter, which applies to all sessions, specifies the length of time a session can be idle before it is terminated. The web-management feature allows you to configure the device using the J-Web interface.

You can also configure the maximum allowed number of concurrent web management sessions using the session-limit parameter.

Options

idle-timeout

minutes

- **Default:** 30
- **Range:** 1 to 1440

Required Privilege Level

system—To view this in the configuration.

system-control—To add this to the configuration.

Release Information

Statement introduced in Junos OS Release 9.0.

RELATED DOCUMENTATION

Firewall User Authentication Overview

Dynamic VPN Overview

inline-tap

IN THIS SECTION

- [Syntax | 327](#)
- [Hierarchy Level | 328](#)
- [Description | 328](#)
- [Required Privilege Level | 328](#)
- [Release Information | 328](#)

Syntax

```
inline-tap;
```

Hierarchy Level

```
[edit security forwarding-process application-services maximize-idp-sessions]
```

Description

Enable IDP inline tap mode. The inline tap feature provides passive, inline detection of application layer threats for traffic matching security policies which have the IDP application service enabled. When a device is in inline tap mode, packets pass through firewall inspection and are also copied to the independent IDP module.

This statement is supported in SRX1500, SRX 5800, SRX 5600, and SRX 5400 devices and vSRX Virtual Firewall.

Required Privilege Level

security—To view this in the configuration.

security-control—To add this to the configuration.

Release Information

Statement introduced in Junos OS Release 10.2.

RELATED DOCUMENTATION

[Understanding Traffic Processing on Security Devices | 2](#)

interface-in (Security Forwarding Options)

IN THIS SECTION

- [Syntax | 329](#)
- [Hierarchy Level | 329](#)
- [Description | 329](#)
- [Required Privilege Level | 329](#)
- [Release Information | 330](#)

Syntax

```
interface-in interface-name;
```

Hierarchy Level

```
[edit security forwarding-options mirror-filter filter-name]
```

Description

Specify the incoming logical interface to be matched for mirroring.

Required Privilege Level

security—To view this in the configuration.

security-control—To add this to the configuration.

Release Information

Statement introduced in Junos OS Release 12.1X46-D10.

RELATED DOCUMENTATION

[mirror-filter \(Security Forwarding Options\) | 345](#)

[show security forwarding-options mirror-filter | 819](#)

interface-out (Security Forwarding Options)

IN THIS SECTION

- [Syntax | 330](#)
- [Hierarchy Level | 330](#)
- [Description | 331](#)
- [Required Privilege Level | 331](#)
- [Release Information | 331](#)

Syntax

```
interface-out interface-name;
```

Hierarchy Level

```
[edit security forwarding-options mirror-filter filter-name]
```

Description

Specify the outgoing logical interface to be matched for mirroring.

Required Privilege Level

security—To view this in the configuration.

security-control—To add this to the configuration.

Release Information

Statement introduced in Junos OS Release 12.1X46-D10.

RELATED DOCUMENTATION

[mirror-filter \(Security Forwarding Options\) | 345](#)

[show security forwarding-options mirror-filter | 819](#)

ipv4-template (Services)

IN THIS SECTION

- [Syntax | 332](#)
- [Hierarchy Level | 332](#)
- [Description | 332](#)
- [Required Privilege Level | 332](#)
- [Release Information | 332](#)

Syntax

```
ipv4-template;
```

Hierarchy Level

```
[edit services flow-monitoring version9 template template-name]
```

Description

Specify that the flow monitoring version 9 template is used only for IPv4 records.

Required Privilege Level

services—To view this in the configuration.

services-control—To add this to the configuration.

Release Information

Statement introduced in Junos OS Release 10.4.

RELATED DOCUMENTATION

[Understanding Traffic Processing on Security Devices | 2](#)

Understanding Interfaces

ipv6-extension-header

IN THIS SECTION

- [Syntax | 333](#)
- [Hierarchy Level | 334](#)
- [Description | 334](#)
- [Options | 334](#)
- [Required Privilege Level | 335](#)
- [Release Information | 335](#)

Syntax

```
ipv6-extension-header {  
    AH-header;  
    ESP-header  
    HIP-header;  
    destination-header {  
        ILNP-nonce-option;  
        home-address-option;  
        line-identification-option;  
        tunnel-encapsulation-limit-option;  
        user-defined-option-type low | <to high>;  
    }  
    fragment-header;  
    hop-by-hop-header {  
        CALIPSO-option;  
        RPL-option;  
        SFM-DPD-option;  
        jumbo-payload-option;  
        quick-start-option;  
        router-alert-option;  
        user-defined-option-type low | <to high>;  
    }  
    mobility-header;
```

```

no-next-header;
routing-header;
shim6-header
user-defined-option-type low | <to high>;
}

```

Hierarchy Level

```
[edit security screen ids-option screen-name ip]
```

Description

Define the IPv6 extension header for the intrusion detection service (IDS).

Options

AH-header	Enable the IPv6 Authentication Header screen option.
ESP-header	Enable the IPv6 Encapsulating Security Payload header screen option.
HIP-header	Enable the IPv6 Host Identify Protocol header screen option.
fragment-header	Enable the IPv6 fragment header screen option.
mobility-header	Enable the IPv6 mobility header screen option.
no-next-header	Enable the IPv6 no next header screen option.
routing-header	Enable the IPv6 routing header screen option.
shim6-header	Enable the IPv6 shim header screen option.
user-defined-header-type <i>low</i> <to <i>high</i>>	<p>Define the type of header range.</p> <ul style="list-style-type: none"> • Range: 0 through 255.

The remaining statements are explained separately. See the [CLI Explorer](#).

Required Privilege Level

security—To view this in the configuration.

security-control—To add this to the configuration.

Release Information

Statement introduced in Junos OS Release 12.1X46-D10.

RELATED DOCUMENTATION

Understanding IPv6 Support for Screens

[hop-by-hop-header](#) | 322

[destination-header](#) | 285

ipv6-extension-header-limit

IN THIS SECTION

- [Syntax](#) | 336
- [Hierarchy Level](#) | 336
- [Description](#) | 336
- [Options](#) | 336
- [Required Privilege Level](#) | 336
- [Release Information](#) | 336

Syntax

```
ipv6-extension-header-limit limit;
```

Hierarchy Level

```
[edit security screen ids-option screen-name ip]
```

Description

Define the IPv6 extension header number limit for screen options. The screen blocks packets that have more than the defined number of extension headers.

Options

limit Set the number of IPv6 extension headers that can pass through the screen.

- **Range:** 0 through 32.

Required Privilege Level

security—To view this in the configuration.

security-control—To add this to the configuration.

Release Information

Statement introduced in Junos OS Release 12.1X46-D10.

RELATED DOCUMENTATION

Understanding IPv6 Support for Screens

[ipv6-extension-header](#) | 333

ipv6-malformed-header

IN THIS SECTION

- [Syntax](#) | 337
- [Hierarchy Level](#) | 337
- [Description](#) | 338
- [Options](#) | 338
- [Required Privilege Level](#) | 338
- [Release Information](#) | 338

Syntax

```
ipv6-malformed-header;
```

Hierarchy Level

```
[edit security screen ids-option screen-name ip]
```

Description

Enable the IPv6 malformed header intrusion detection service (IDS) option. The screen will not pass any communication using the subnet 2001:db8 :: / 32.

Options

This has no options.

Required Privilege Level

security—To view this in the configuration.

security-control—To add this to the configuration.

Release Information

Statement introduced in Junos OS Release 12.1X46-D10.

RELATED DOCUMENTATION

Understanding IPv6 Support for Screens

[ipv6-extension-header](#) | 333

ipv6-template (Services)

IN THIS SECTION

● [Syntax](#) | 339

- Hierarchy Level | 339
- Description | 339
- Required Privilege Level | 339
- Release Information | 339

Syntax

```
ipv6-template;
```

Hierarchy Level

```
[edit services flow-monitoring version9 template template-name]
```

Description

Specify that the flow monitoring version 9 template is used only for IPv6 records.

Required Privilege Level

services—To view this in the configuration.

services-control—To add this to the configuration.

Release Information

Statement introduced in Junos OS Release 12.1X45-D10.

RELATED DOCUMENTATION

[Understanding Traffic Processing on Security Devices | 2](#)

Understanding Interfaces

low-latency

IN THIS SECTION

- [Syntax | 340](#)
- [Hierarchy Level | 340](#)
- [Description | 340](#)
- [Required Privilege Level | 341](#)
- [Release Information | 341](#)

Syntax

```
low-latency
```

Hierarchy Level

```
[edit chassis fpc fpc-slot-number pic pic-slot-number services-offload]
```

Description

Enables the low-latency mode on the selected NP-IOC. Low-latency is not enabled by default. The low latency allows you to configure the mode of the network processor's traffic manager (TM) on the egress

path. If low latency is enabled, the network processor is initialized without the traffic manager, thus reducing the overall latency in the Express Path (formerly known as services offloading).

NOTE: Because all SRX Series CoS functions are supported by the traffic manager, CoS functions are not supported when low latency is enabled.

Required Privilege Level

security—To view this in the configuration.

security-control—To add this to the configuration.

Release Information

Statement introduced in Junos OS Release 12.1X44-D10.

RELATED DOCUMENTATION

[Understanding Traffic Processing on Security Devices | 2](#)

Example: Configuring Low Latency

low-watermark

IN THIS SECTION

- [Syntax | 342](#)
- [Hierarchy Level | 342](#)
- [Description | 342](#)
- [Options | 342](#)
- [Required Privilege Level | 342](#)

Syntax

```
low-watermark percent;
```

Hierarchy Level

```
[edit security flow aging]
```

Description

Set the point at which the aggressive aging-out process ends.

Options

percent —Percentage of session-table capacity at which aggressive aging-out ends.

- **Range:** 0 through 100 percent
- **Default:** 100 percent

Required Privilege Level

security—To view this in the configuration.

security-control—To add this to the configuration.

Release Information

Statement introduced in Junos OS Release 8.5.

RELATED DOCUMENTATION

[Understanding Traffic Processing on Security Devices](#) | 2

maximize-idp-sessions

IN THIS SECTION

- [Syntax](#) | 343
- [Hierarchy Level](#) | 343
- [Description](#) | 344
- [Options](#) | 344
- [Required Privilege Level](#) | 344
- [Release Information](#) | 344

Syntax

```
maximize-idp-sessions {  
    weight (Security) (equal | firewall | idp);  
}
```

Hierarchy Level

```
[edit security forwarding-process application-services]
```

Description

If you are deploying IDP policies, you can tune the device to increase IDP session capacity. By using the provided commands to change the way the system allocates resources, you can achieve a higher IDP session capacity. See `weight` for information about the options provided.

This statement is supported on SRX1500, SRX 5800, SRX 5600, and SRX 5400 devices and vSRX Virtual Firewall.

NOTE: The IDP session capacity is restricted to 100,000 sessions per SPU.

Options

The remaining statements are explained separately. See [CLI Explorer](#).

Required Privilege Level

`security`—To view this in the configuration.

`security-control`—To add this to the configuration.

Release Information

Statement introduced in Junos OS Release 9.6.

RELATED DOCUMENTATION

[Understanding Traffic Processing on Security Devices | 2](#)

mirror-filter (Security Forwarding Options)

IN THIS SECTION

- [Syntax | 345](#)
- [Hierarchy Level | 345](#)
- [Description | 346](#)
- [Options | 347](#)
- [Required Privilege Level | 347](#)
- [Release Information | 347](#)

Syntax

```
mirror-filter filter-name {  
    destination-port port-number;  
    destination-prefix destination-prefix;  
    interface-in interface-name;  
    interface-out interface-name;  
    output (Security Forwarding Options) {  
        destination-mac mac-address;  
        interface interface-name;  
    }  
    protocol protocol;  
    source-port port-number;  
    source-prefix set source-prefix;  
}
```

Hierarchy Level

[edit security forwarding-options]

Description

Configure a mirror filter for filtering X2 packets to be mirrored and sent to a packet analyzer.

As a network operator, you need a way to monitor X2 traffic to debug any handover issues across eNodeBs. The mirror filter feature allows you to do that. Traffic coming out of an IPsec tunnel is decrypted, mirrored and analyzed, and then encrypted again to go into the outbound IPsec tunnel.

To use the mirror filter feature to monitor X2 traffic, you configure mirror filters. You can configure up to 15 different mirror filters to be used concurrently to filter for various kinds of traffic. Each mirror filter contains a set of parameters and their values against which traffic is matched.

NOTE: The SRX Series mirror filter feature is bidirectional, much like a session. X2 traffic flowing through an IPSec VPN from devices that match the configured filter conditions is mirrored and analyzed.

Starting in Junos OS Release 18.4R1, if the output X2 interface of a mirror filter is configured for an st0 interface to filter traffic that you want to analyze, the packet is duplicated and encrypted by the IPsec tunnel bound to the st0 interface. This enhancement supports the SRX Series Firewalls to send traffic mirrored from a port on an IPsec tunnel.

In addition to the following parameters for a mirror filter, you specify the output interface and the MAC address of the packet analyzer as part of the configuration.

NOTE: Although there is no minimum required number of parameters for a mirror filter, please be mindful that if you specify too few criteria or accidentally commit an incomplete filter, an over-proportional amount of traffic flow through the system could be mirrored.

- destination IP address prefix
- destination port
- IP protocol
- source IP address prefix
- source port
- incoming and outgoing interfaces

Options

The remaining statements are explained separately. See [CLI Explorer](#).

Required Privilege Level

security—To view this in the configuration.

security-control—To add this to the configuration.

Release Information

Statement introduced in Junos OS Release 12.1X46-D10.

RELATED DOCUMENTATION

[show security forwarding-options mirror-filter | 819](#)

[clear security forward-options mirror filter | 488](#)

mode (Security Forwarding Options)

IN THIS SECTION

- [Syntax | 348](#)
- [Hierarchy Level | 348](#)
- [Description | 348](#)
- [Options | 348](#)
- [Required Privilege Level | 349](#)
- [Release Information | 349](#)

Syntax

```
mode (drop | flow-based | packet-based);
```

Hierarchy Level

```
[edit security forwarding-options family inet6]
```

Description

Specify forwarding options for IPv6 traffic.

Options

- `drop`—Drop IPv6 packets. This is the default setting.
- `flow-based`—Perform flow-based packet forwarding.
- `packet-based`—Perform simple packet forwarding.

NOTE: Packet-based processing is not supported on the following SRX Series Firewalls: SRX5400, SRX5600, and SRX5800.

- Starting with Junos OS Release 15.1X49-D70, on SRX1500, SRX4100, SRX4200, SRX5400, SRX5600, SRX5800 devices, the default mode is changed from drop mode to flow based mode.
- If you change the forwarding option mode for IPv6, you might have to perform a reboot to initialize the configuration change. [Table 20 on page 349](#) summarizes device status upon configuration change.
- Starting with Junos OS Release 15.1X49-D70, on SRX5400, SRX5600, and SRX5800 devices, reboot is not required when you change the modes between flow-based mode and drop mode.

Table 20: Device Status Upon Configuration Change

Configuration Change	Commit Warning	Reboot Required	Impact on Existing Traffic Before Reboot	Impact on New Traffic Before Reboot
Drop to flow-based	Yes	Yes	Dropped	Dropped
Drop to packet-based	No	No	Packet-based	Packet-based
Flow-based to packet-based	Yes	Yes	None	Flow sessions created
Flow-based to drop	Yes	Yes	None	Flow sessions created
Packet-based to flow-based	Yes	Yes	Packet-based	Packet-based
Packet-based to drop	No	No	Dropped	Dropped

Required Privilege Level

security—To view this in the configuration.

security-control—To add this to the configuration.

Release Information

Support on SRX Series Firewalls for flow-based mode for family inet6 added in Junos OS Release 10.2.

RELATED DOCUMENTATION

[Understanding Traffic Processing on Security Devices](#) | 2

no-sequence-check

IN THIS SECTION

- [Syntax | 350](#)
- [Hierarchy Level | 350](#)
- [Description | 350](#)
- [Required Privilege Level | 351](#)
- [Release Information | 351](#)

Syntax

```
no-sequence-check;
```

Hierarchy Level

```
[edit security flow tcp-session]
```

Description

Specify that the device does not check sequence numbers in TCP segments during stateful inspection. By default, the device monitors the sequence numbers in TCP segments. The device detects the window scale specified by source and destination hosts in a session and adjusts a window for an acceptable range of sequence numbers according to their specified parameters. The device then monitors the sequence numbers in packets sent between these hosts. If the device detects a sequence number outside this range, it drops the packet.

Required Privilege Level

security—To view this in the configuration.

security-control—To add this to the configuration.

Release Information

Statement introduced in Junos OS Release 8.5.

RELATED DOCUMENTATION

[Understanding Traffic Processing on Security Devices | 2](#)

np-cache (Flexible PIC Concentrator)

IN THIS SECTION

- [Syntax | 351](#)
- [Hierarchy Level | 352](#)
- [Description | 352](#)
- [Options | 352](#)
- [Required Privilege Level | 353](#)
- [Release Information | 353](#)

Syntax

```
np-cache;
```

Hierarchy Level

```
[edit chassis fpc fpc-slot-number]
```

Description

Enable session cache table on IOC.

Starting with Junos OS Release 15.1X49-D10 and Junos OS Release 17.3R1, NP cache is supported on the SRx5K-MPC (IOC2), SRX5K-MPC3-100G10G (IOC3), and SRX5K-MPC3-40G10G (IOC3) for SRX5400, SRX5600, and SRX5800 devices.

The security policy determines whether a session is for Express Path (formerly known as *services offloading*) mode on the selected Flexible PIC Concentrator (FPC).

NOTE: The IOC2 and the IOC3 utilize the delay sessions delete mechanism. The same sessions (sessions with the same five tuples) that are deleted and then reinstalled immediately are not cached on the IOCs.

NOTE: In a cluster deployment, when you configure `np-cache` for an IOC card from node0, the IOC cards on both cluster nodes are activated.

NOTE: To enable IPsec VPN affinity, you must also enable the session cache on IOCs (IOC2 and IOC3) by using the `set chassis fpc <fpc-slot> np-cache` command.

Options

Required Privilege Level

security—To view this in the configuration.

security-control—To add this to the configuration.

Release Information

Statement introduced in Junos OS Release 15.1X49-D10.

RELATED DOCUMENTATION

Example: Configuring an SRX5K-MPC on an SRX5000 Line Device to Support Express Path

output (Security Forwarding Options)

IN THIS SECTION

- [Syntax | 353](#)
- [Hierarchy Level | 354](#)
- [Description | 354](#)
- [Options | 354](#)
- [Required Privilege Level | 354](#)
- [Release Information | 355](#)

Syntax

```
output {  
    destination-mac mac-address;
```

```
interface interface-name;  
}
```

Hierarchy Level

```
[edit security forwarding-options mirror-filter filter-name]
```

Description

Specify the MAC address or interface for mirrored traffic.

Starting in Junos OS Release 18.4R1, if the output X2 interface of a mirror filter is configured for an st0 interface to filter traffic that you want to analyze, the packet is duplicated and encrypted by the IPsec tunnel bound to the st0 interface. This enhancement supports the SRX Series Firewalls to send traffic mirrored from a port on an IPsec tunnel.

Options

destination-mac <i>mac-address</i>	Specify the MAC address for the mirrored traffic.
interface <i>interface-name</i>	Specify the logical interface for the mirrored traffic.

Required Privilege Level

security—To view this in the configuration.

security-control—To add this to the configuration.

Release Information

Statement introduced in Junos OS Release 12.1X46-D10.

RELATED DOCUMENTATION

[mirror-filter \(Security Forwarding Options\) | 345](#)

[show security forwarding-options mirror-filter | 819](#)

packet-filter

IN THIS SECTION

- [Syntax | 355](#)
- [Hierarchy Level | 356](#)
- [Description | 356](#)
- [Options | 356](#)
- [Required Privilege Level | 357](#)
- [Release Information | 357](#)

Syntax

```
packet-filter packet-filter-name {  
  action-profile profile-name {  
    destination-port (Security Forwarding Options) (port-range | protocol-name);  
    destination-prefix destination-prefix;  
    interface logical-interface-name;  
    protocol (Security Forwarding Options) (protocol-number | protocol-name);  
    source-port (Security Forwarding Options) (port-range | protocol-name);  
    source-prefix source-prefix;  
  }  
}
```

Hierarchy Level

```
[edit security datapath-debug]
```

Description

Set packet filter for taking the datapath-debug action. A filter is defined to filter traffic, then an action profile is applied to the filtered traffic. Be sure to configure multiple packet filters to capture the traffic. One packet filter only captures the traffic as specified in it, such as from one source to one destination. The same packet filter will not capture the traffic in the reverse direction. You need to configure another packet filter to capture the traffic in reverse direction and specify the source and destination according to the response packet in it. The action profile specifies a variety of actions on the processing unit. A maximum of four filters are supported at the same time. Packet filters can be configured with source and destination prefix and port (including ranges), and protocol.

Action-profile settings have no specific minimum setting, it is based on trace, count, packet summary and packet-dump. Enabling end-to-end debugging without or with a very broad filter is not recommended. This could result in a high PFE CPU usage. Therefore when selecting what to capture through a filter care must be taken. List as many and specific criteria which then results in the minimum amount of traffic to be captured.

NOTE: Packet filter is supported on SRX1400, SRX3400, SRX3600, SRX5400, SRX5600, and SRX5800 devices.

Options

- `action-profile profile-name`—Identify the action profile to use. You can specify the name of the action profile to use. Using the request security action-profile command, you can set the action for the packet match for a specified filter. Action-profile must be defined.
- `destination-port (port-range | protocol name)`—Specify a destination port to match TCP/UDP destination port.
- `destination-prefix destination-prefix`—Specify a destination IPv4/IPv6 address prefix.
- `interface logical-interface-name`—Specify a logical interface name.

- `protocol` (*protocol-number* | *protocol-name*)—Match IP protocol type.
- `source-port` (*port-range* | *protocol-name*)—Match TCP/UDP source port.
- `source-prefix` *source-prefix*—Specify a source IP address prefix.

Required Privilege Level

`security`—To view this in the configuration

`security-control`—To add this to the configuration.

Release Information

Command introduced in Junos OS Release 9.6 ; Support for IPv6 addresses for the `destination-prefix` and `source-prefix` options added in Junos OS Release 10.4.

packet-log (Security Flow)

IN THIS SECTION

- [Syntax | 358](#)
- [Hierarchy Level | 358](#)
- [Description | 358](#)
- [Options | 358](#)
- [Required Privilege Level | 359](#)
- [Release Information | 359](#)

Syntax

```
packet-log {  
    enable;  
    throttle-interval;  
    packet-filter <filter-name>;  
}
```

Hierarchy Level

```
[edit security flow ]
```

Description

Configure flow packet log.

Starting in Junos OS Release 17.3R1, SRX Series Firewalls support logging of unsynchronized out-of-state TCP packets that are dropped by the flow module.

The logging functionality will allow notifications to the administrators (or automated systems) about any of TCP out-of-state packets drops.

Options

enable	Enable log for dropped packets.
packet-filter	Configure packet log filter.
throttle-interval	Configure the interval as a power of two (0..32768 milliseconds).

Required Privilege Level

security—To view this in the configuration.

security-control—To add this to the configuration.

Release Information

Statement introduced in Junos OS Release 17.3R1.

packet-ordering-mode (Application Services)

IN THIS SECTION

- [Syntax | 359](#)
- [Hierarchy Level | 360](#)
- [Description | 360](#)
- [Options | 360](#)
- [Required Privilege Level | 360](#)
- [Release Information | 360](#)

Syntax

```
packet-ordering-mode {  
    (hardware | software);  
}
```

Hierarchy Level

[edit security forwarding-process application-services]

Description

Enables or disables the packet-ordering functionality using the Packet Ordering Engine. By default, packet-ordering functionality using the Packet Ordering Engine (hardware) is enabled.

A system reboot is required when this feature is enabled or disabled, and a warning message is displayed during the commit.

NOTE: Packet-ordering functionality using Packet Ordering Engine is supported on SRX5800 and SRX5600 devices with next-generation SPCs. Starting from Junos OS release 12.1X46-D10, SRX5400 device with next-generation SPCs also supports this feature.

Options

hardware Enables packet-ordering functionality using the Packet Ordering Engine.

software Disables packet-ordering functionality using the Packet Ordering Engine.

Required Privilege Level

- security—To view this in the configuration.
- security-control—To add this to the configuration.

Release Information

Statement introduced in Junos OS Release 12.1X45-D10. This statement is supported.

RELATED DOCUMENTATION

[Understanding Traffic Processing on Security Devices | 2](#)

pending-sess-queue-length

IN THIS SECTION

- [Syntax | 361](#)
- [Hierarchy Level | 361](#)
- [Description | 361](#)
- [Options | 362](#)
- [Required Privilege Level | 362](#)
- [Release Information | 362](#)

Syntax

```
pending-sess-queue-length (high | moderate | normal);
```

Hierarchy Level

```
[edit security flow]
```

Description

Configure the maximum queued length per pending session.

Options

- `high`— Allow the maximum number of queued sessions.
- `moderate`—Allow more queued sessions than the normal number.
- `normal`—Allow the normal number of queued session.

Required Privilege Level

`security`—To view this in the configuration.

`security-control`—To add this to the configuration.

Release Information

Statement introduced in Junos OS Release 11.4.

RELATED DOCUMENTATION

| [Understanding Traffic Processing on Security Devices | 2](#)

power-mode-disable

IN THIS SECTION

- [Syntax | 363](#)
- [Hierarchy Level | 363](#)
- [Release Information | 363](#)
- [Description | 363](#)
- [Required Privilege Level | 363](#)

Syntax

```
power-mode-disable;
```

Hierarchy Level

```
[edit security flow]
```

Release Information

Statement introduced in Junos OS Release 21.3R1.

Description

PowerMode is enabled by default. To disable the feature, use `power-mode-disable` statement at the `[edit security flow]` hierarchy level.

Required Privilege Level

```
security
```

RELATED DOCUMENTATION

[PowerMode](#) | 96

pre-id-default-policy

IN THIS SECTION

- [Syntax | 364](#)
- [Hierarchy Level | 365](#)
- [Description | 365](#)
- [Options | 365](#)
- [Required Privilege Level | 366](#)
- [Release Information | 366](#)

Syntax

```
pre-id-default-policy {
  then {
    log {
      session-init;
      session-close;
    }
    session-timeout {
      icmp seconds;
      icmp6 seconds;
      ospf seconds;
      others seconds;
      tcp seconds;
      udp seconds;
    }
  }
}
```

Hierarchy Level

[edit security policies]

Description

During the initial policy lookup phase, which occurs prior to a dynamic application being identified, if there are multiple policies present in the potential policy list, the SRX Series Firewall applies the default security policy until a more explicit match has occurred. Configures default policy actions that occur prior to dynamic application identification (AppID).



CAUTION: Configuring session-init logging for the pre-id-default-policy can generate a large amount of logs. Each session that enters the SRX that initially matches the pre-id-default-policy will generate an event. We recommend only using this option for troubleshooting purposes.

Options

then Specifies the policy action that has to be taken when the packet matches the criteria.

log Specifies the log details at session close time and session initialization time.

- Values:
 - session-init—Log at the beginning of a session
 - session-close—Log at the closure of a session

NOTE: In recent versions of Junos OS, the factory-default configuration of an SRX includes the session-close knob. If not already present, we recommend that customers implement session-close logging within their pre-id-default-policy. This will ensure security logs are generated by the SRX if a flow is unable to leave the pre-id-default-policy. These events are generally a result of JDPI being unable to

properly classify traffic, although they may also indicate potential attempts at evading the APPID engine.

session-timeout

When you update a session, the session timeout is configured, which specifies the session timeout details in seconds.

- **Values:** icmp—Timeout value for ICMP sessions (seconds)
- **Range:** 4 through 86,400
- **Values:** icmp6—Timeout value for ICMP6 sessions (seconds)
- **Range:** 4 through 86,400
- **Values:** ospf—Timeout value for OSPF sessions (seconds)
- **Range:** 4 through 86,400
- **Values:** others—Timeout value for other sessions (seconds)
- **Range:** 4 through 86,400
- **Values:** tcp—Timeout value for TCP sessions (seconds)
- **Range:** 4 through 86,400
- **Values:** udp—Timeout value for UDP sessions (seconds)
- **Range:** 4 through 86,400

Required Privilege Level

security—To view this statement in the configuration.

security-control—To add this statement to the configuration.

Release Information

Statement introduced in Junos OS Release 18.2R1.

RELATED DOCUMENTATION

| *Understanding Advanced Policy-Based Routing*

preserve-incoming-fragment-size

IN THIS SECTION

- [Syntax | 367](#)
- [Hierarchy Level | 367](#)
- [Description | 367](#)
- [Required Privilege Level | 368](#)
- [Release Information | 368](#)

Syntax

```
preserve-incoming-fragment-size;
```

Hierarchy Level

```
[edit security flow] ]
```

Description

Enable the preserve incoming fragment size feature that allows the SRX Series Firewall to preserve the size of incoming fragments to be used in determining the best maximum transmission unit (MTU) size for the egress interface.

When data is sent from one host to another, it is transmitted as a series of packets. Performance is improved and network resources are conserved when packets of the largest size can transit the path from the source node to the destination node without being fragmented at any link in the datapath.

If application-layer services are configured on the SRX Series Firewall, packet fragments at the ingress interface must be reassembled before the services can be applied and the content inspected. These reassembled packet fragments must be broken down again before the data is transmitted out the egress interface.

When a packet must be fragmented into smaller packets to transit a link in the path because the packet is larger than the MTU size established for that link, each of the resulting fragments must contain packet header information, in addition to the payload, or data. The increased overhead can lower throughput and degrade network performance. Also, the packet fragments must be reassembled at the destination node, which consumes additional network resources.

By default, the SRX Series Firewall uses the MTU size configured for the egress interface to determine the size for the packet fragments it transmits. However, if you enable the preserve incoming fragment size feature, the SRX Series Firewall detects and saves the size of incoming packet fragments and takes that into account. To diminish the likelihood of packet fragmentation in the datapath, the SRX Series Firewall sets the egress interface MTU size to the smaller of two values: It identifies the maximum size of all incoming fragments and it compares that size to the existing MTU size of the egress interface. The SRX Series Firewall takes the smaller number and uses it for the egress interface MTU size.

Required Privilege Level

security—To view this statement in the configuration.

security-control—To add this statement to the configuration.

Release Information

Statement introduced in Junos OS Release 15.1X49-D100.

RELATED DOCUMENTATION

[Understanding How Preserving Incoming Fragmentation Characteristics Can Improve Throughput](#) | 70

propagate-settings

IN THIS SECTION

- [Syntax | 369](#)
- [Hierarchy Level | 369](#)
- [Description | 369](#)
- [Options | 370](#)
- [Required Privilege Level | 370](#)
- [Release Information | 370](#)

Syntax

```
propagate-settings interface-name;
```

Hierarchy Level

```
[edit system services dhcp]  
[edit system services dhcp pool]
```

Description

Enable or disable the propagation of TCP/IP settings received on the device acting as Dynamic Host Configuration Protocol (DHCP) client. The settings can be propagated to the server pool running on the device. Use the `system services dhcp` to set this feature globally. Use the `system services dhcp pool` to set the feature for the address pool and override the global setting.

Options

logical-interface-name —Name of the logical interface to receive TCP/IP settings from the external network for propagation to the DHCP pool running on the device.

Required Privilege Level

system—To view this in the configuration.

system-control—To add this to the configuration.

Release Information

Statement introduced in Junos OS Release 8.5.

RELATED DOCUMENTATION

[Understanding Traffic Processing on Security Devices | 2](#)

protocol (Security Forwarding Options)

IN THIS SECTION

- [Syntax | 371](#)
- [Hierarchy Level | 371](#)
- [Description | 371](#)
- [Options | 371](#)
- [Required Privilege Level | 372](#)
- [Release Information | 372](#)

Syntax

```
protocol protocol;
```

Hierarchy Level

```
[edit security forwarding-options mirror-filter filter-name]
```

Description

Specify the networking protocol name or number to be matched for mirroring.

Options

protocol-name Networking protocol name or number. The following text values are supported. For a complete list of possible numeric values, see RFC 1700, *Assigned Numbers (for the Internet Protocol Suite)*.

ah	IP Security Authentication header
egp	Exterior gateway protocol
esp	IPsec Encapsulating Security Payload
gre	Generic routing encapsulation
icmp	Internet Control Message Protocol
icmp6	Internet Control Message Protocol version 6
igmp	Internet Group Management Protocol
ipip	IP over IP

<code>ospf</code>	Open Shortest Path First
<code>pim</code>	Protocol Independent Multicast
<code>rsvp</code>	Resource Reservation Protocol
<code>sctp</code>	Stream Control Transmission Protocol
<code>tcp</code>	Transmission Control Protocol
<code>udp</code>	User Datagram Protocol

Required Privilege Level

`security`—To view this in the configuration.

`security-control`—To add this to the configuration.

Release Information

Statement introduced in Junos OS Release 12.1X46-D10.

RELATED DOCUMENTATION

[mirror-filter \(Security Forwarding Options\) | 345](#)

[show security forwarding-options mirror-filter | 819](#)

resource-manager

IN THIS SECTION

 [Syntax | 373](#)

- Hierarchy Level | 373
- Description | 373
- Options | 373
- Required Privilege Level | 374
- Release Information | 374

Syntax

```
resource-manager {  
    traceoptions (Security) {  
        flag flag;  
    }  
}
```

Hierarchy Level

```
[edit security]
```

Description

Configure resource manager security options.

Options

The remaining statements are explained separately. See [CLI Explorer](#).

Required Privilege Level

security—To view this in the configuration.

security-control—To add this to the configuration.

Release Information

Statement introduced before Junos OS Release 12.1.

RELATED DOCUMENTATION

[Understanding Traffic Processing on Security Devices | 2](#)

reverse-route-packet-mode-vr

IN THIS SECTION

- [Syntax | 374](#)
- [Hierarchy Level | 375](#)
- [Description | 375](#)
- [Required Privilege Level | 375](#)
- [Release Information | 375](#)

Syntax

```
reverse-route-packet-mode-vr;
```

Hierarchy Level

```
[edit security flow advanced-options]
```

Description

When processing a server to client traffic, if the route is changed, the server to client traffic is rerouted. The traffic is rerouted using the virtual router from the first incoming session interface. The command allows reverse route lookup with packet mode using virtual router.

Required Privilege Level

security—To view this statement in the configuration.

security-control—To add this statement to the configuration.

Release Information

Statement introduced in Junos OS Release 18.2R1.

RELATED DOCUMENTATION

| [Understanding Packet-Based Processing | 215](#)

route-change-timeout

IN THIS SECTION

● [Syntax | 376](#)

- Hierarchy Level | 376
- Description | 376
- Options | 376
- Required Privilege Level | 377
- Release Information | 377

Syntax

```
route-change-timeout seconds;
```

Hierarchy Level

```
[edit security flow]
```

Description

Specify the session timeout when a session is rerouted but there is a reroute failure (for example, the new route uses a different egress zone from the previous route).

Options

seconds —Amount of time before sessions are timed out.

- **Range:** 6 through 1800 seconds
- **Default:** 30 seconds

Required Privilege Level

security—To view this in the configuration.

security-control—To add this to the configuration.

Release Information

Statement introduced in Junos OS Release 8.5. Support.

RELATED DOCUMENTATION

[Understanding Traffic Processing on Security Devices | 2](#)

rst-invalidate-session

IN THIS SECTION

- [Syntax | 377](#)
- [Hierarchy Level | 378](#)
- [Description | 378](#)
- [Required Privilege Level | 378](#)
- [Release Information | 378](#)

Syntax

```
rst-invalidate-session;
```

Hierarchy Level

```
[edit security flow tcp-session]
```

Description

Enable the device to mark a session for immediate termination when it receives a TCP reset (RST) message. By default, this feature is disabled.

NOTE: On SRX Series Firewalls with `rst-invalidate-session` configured the invalidation of the session occurs immediately whereas without `rst-invalidate-session` configured the session is set to time out 2 seconds after a TCP reset (RST) message has been received.

Required Privilege Level

security—To view this in the configuration.

security-control—To add this to the configuration.

Release Information

Statement introduced in Junos OS Release 8.5.

RELATED DOCUMENTATION

[Understanding Traffic Processing on Security Devices | 2](#)

rst-sequence-check

IN THIS SECTION

- [Syntax | 379](#)
- [Hierarchy Level | 379](#)
- [Description | 379](#)
- [Required Privilege Level | 380](#)
- [Release Information | 380](#)

Syntax

```
rst-sequence-check;
```

Hierarchy Level

```
[edit security flow tcp-session]
```

Description

Verify that the TCP sequence number in a TCP segment with the RST bit enabled matches the previous sequence number for a packet in that session or is the next higher number incrementally. If the sequence number does not match either of these expected numbers, the device drops the packet and sends the host a TCP ACK message with the correct sequence number. By default, this check is disabled.

Required Privilege Level

security—To view this in the configuration.

security-control—To add this to the configuration.

Release Information

Statement introduced in Junos OS Release 8.5.

RELATED DOCUMENTATION

[Understanding Traffic Processing on Security Devices | 2](#)

security-service (Security Forwarding Options)

IN THIS SECTION

- [Syntax | 380](#)
- [Hierarchy Level | 381](#)
- [Description | 381](#)
- [Options | 381](#)
- [Required Privilege Level | 381](#)
- [Release Information | 382](#)

Syntax

```
security-service (fail-open);
```

Hierarchy Level

```
[edit security forwarding-options]
```

Description

The system resource management guarantees the resources are used according to priorities. the fail-open/fail-close impacts the new session creation only when the system resource is busy.

- If system resource is not busy, fail-open/fail-close won't take effect. No impact to traffic.
- If system resource is busy and the new session need not be created with Layer 7 services that require the system resource, then no impact to traffic.
- . If system resource is busy, and the new session needs be created with Layer 7 services that require the system resource:
 - Fail-close (default), drops the packet and won't create the session
 - Fail-open, creates a flow session without the Layer 7 services that require the resource, and forward the packet out.

Options

- fail-open—Ignores Layer 7 services with resource requirements, creates a flow session without Layer 7 services, and forward the packet out.

Required Privilege Level

security—To view this in the configuration.

security-control—To add this to the configuration.

Release Information

Support on SRX Series Firewalls for flow based security-service in Junos OS Release 20.4R1.

RELATED DOCUMENTATION

[Understanding Traffic Processing on Security Devices | 2](#)

services-memory (resource-manager)

IN THIS SECTION

- [Syntax | 382](#)
- [Hierarchy Level | 383](#)
- [Description | 383](#)
- [Options | 383](#)
- [Required Privilege Level | 384](#)
- [Release Information | 384](#)

Syntax

```
services-memory {  
  match {  
    threshold threshold;  
  }  
  then {  
    alarm;  
    drop-flows;  
    fail-close;  
    fail-open;  
    log;  
  }  
}
```

```
}
}
```

Hierarchy Level

```
[edit security resource-manager]
```

Description

Configure resource manager services-memory options to control the behavior of the device based on memory load.

Options

- `threshold threshold`-Configure the threshold limit to let `resource-manager` take actions when the service memory load exceeds the threshold. The range is 1 to 100 percent.
- `fail-close`-This configuration closes a session when there is not enough memory for a service during session setup. This configuration drops a packet if there is not memory during fast path. This is the default configuration.
- `fail-open`-This configuration opens a infra session even if there is not enough memory for a service to allocate memory.
- `drop-flows`-When you mark a session as a drop-flow, it bypasses the first path for each new packet, which matches the original drop session for next 4 seconds only. This configuration drops the packets that match the drop-flows.
- `log`-This configuration logs messages when the resource threshold is exceeded and falls back under the threshold, and what is the protective action taken.
- `alarm`-This configuration sends an SNMP trap when the memory load exceeds the threshold.

Required Privilege Level

security—To view this in the configuration.

security-control—To add this to the configuration.

Release Information

Statement introduced in Junos OS Release 20.4R1.

RELATED DOCUMENTATION

[Understanding Traffic Processing on Security Devices | 2](#)

session-memory (resource-manager)

IN THIS SECTION

- [Syntax | 384](#)
- [Hierarchy Level | 385](#)
- [Description | 385](#)
- [Options | 385](#)
- [Required Privilege Level | 386](#)
- [Release Information | 386](#)

Syntax

```
session-memory {  
  match {  
    threshold threshold;  }  
}
```



```

}
then {
    alarm;
    drop-flows;
    log;
    session-aggressive-ageout {
        early-ageout early-ageout;
    }
}
}
}

```

Hierarchy Level

[edit security resource-manager]

Description

Configure resource manager session-memory options to control the behavior of the device based on the sessions that the device is handling.

Options

- `threshold threshold`-Configure the threshold limit to let `resource-manager` take actions. The range is 1 to 100 percent.
- `session-aggressive-ageout early-ageout seconds`-When you enable aggressive ageout, sessions with timeout less than the early value, become invalid. Range is 1 through 65,535 seconds.
- `drop-flows`-When you mark a session as a drop-flow, it bypasses the first path for each new packet, which matches the original drop session, for next 4 seconds only. This configuration drops the packets that match the drop-flows.
- `log`-This configuration logs messages when the resource threshold is exceeded and falls back under the threshold.
- `alarm`-This configuration sends an SNMP trap when the session usage exceeds the threshold.

Required Privilege Level

security—To view this in the configuration.

security-control—To add this to the configuration.

Release Information

Statement introduced in Junos OS Release 20.4R1.

RELATED DOCUMENTATION

[Understanding Traffic Processing on Security Devices | 2](#)

sampling

IN THIS SECTION

- [Syntax | 386](#)
- [Hierarchy Level | 387](#)
- [Description | 387](#)
- [Options | 387](#)
- [Required Privilege Level | 387](#)
- [Release Information | 388](#)

Syntax

```
sampling {  
  command binary-file-path;  
  disable;
```

```
failover (alternate-media | other-routing-engine);  
}
```

Hierarchy Level

[edit system processes]

Description

Perform packet sampling based on particular input interfaces and various fields in the packet header.

Options

- `command binary-file-path`—Path to the binary process.
- `disable`—Disable the traffic sampling control process.
- `failover`—Configure the device to reboot if the software process fails four times within 30 seconds, and specify the software to use during the reboot.
 - `alternate-media`—Configure the device to switch to backup media that contains a version of the system if a software process fails repeatedly.
 - `other-routing-engine`—Instruct the secondary Routing Engine to take primary role if a software process fails. If this is configured for a process, and that process fails four times within 30 seconds, then the device reboots from the secondary Routing Engine.

Required Privilege Level

`system`—To view this in the configuration.

`system-control`—To add this to the configuration.

Release Information

Statement introduced in Junos OS Release 8.5.

RELATED DOCUMENTATION

[Understanding Traffic Processing on Security Devices](#) | 2

services-offload

IN THIS SECTION

- [Syntax](#) | 388
- [Hierarchy Level](#) | 389
- [Description](#) | 389
- [Options](#) | 389
- [Required Privilege Level](#) | 389
- [Release Information](#) | 389

Syntax

```
services-offload {  
  low-latency;  
  per-session-statistics;  
}
```

Hierarchy Level

```
[edit chassis fpc fpc-slot-number pic pic-slot-number]
```

Description

Enables the Express Path mode (formerly known as *services offloading*) mode on the selected network processor. Services-offload is not enabled by default.

When services-offload is enabled, only the first packets of a session goes to the Services Processing Unit (SPU), rest of packets in services-offload mode does not go to SPU, therefore some security features such as stateful screen are not supported. Only TCP and UDP packets can be services offloaded.

Options

The remaining statements are explained separately. See [CLI Explorer](#).

Required Privilege Level

security—To view this in the configuration.

security-control—To add this to the configuration.

Release Information

Statement introduced in Junos OS Release 11.4.

RELATED DOCUMENTATION

[Understanding Traffic Processing on Security Devices](#) | 2

session (System Services)

IN THIS SECTION

- [Syntax | 390](#)
- [Hierarchy Level | 390](#)
- [Description | 390](#)
- [Options | 391](#)
- [Required Privilege Level | 391](#)
- [Release Information | 391](#)

Syntax

```
session {  
    idle-timeout minutes;  
    session-limit number;  
}
```

Hierarchy Level

```
[edit system services web-management]
```

Description

Configure parameters for web-management sessions. Web management allows for configuration of the SRX Series Firewall using the J-Web interface. You can configure the idle-timeout parameter for web-management sessions and the maximum number of concurrent sessions.

Options

idle-timeout
minutes Configure in minutes the time-out parameter for all web-management sessions. The idle-timeout parameter specifies the length of time that a session can be idle before it is terminated.

- **Default:** 1440
- **Range:** 1 to 1440

session-limit
number Configure the maximum allowed number of concurrent web management sessions. By default, an unlimited number of users can log in to the J-Web interface on a Juniper Networks device, and each session remains open for 24 hours (1440 minutes).

- **Default:** unlimited
- **Range:** 1 to 1024

Required Privilege Level

system—To view this in the configuration.

system-control—To add this to the configuration.

Release Information

Statement introduced in Junos OS Release 9.0.

RELATED DOCUMENTATION

Firewall User Authentication Overview

Dynamic VPN Overview

session-limit (System Services)

IN THIS SECTION

- [Syntax | 392](#)
- [Hierarchy Level | 392](#)
- [Description | 392](#)
- [Options | 393](#)
- [Required Privilege Level | 393](#)
- [Release Information | 393](#)

Syntax

```
session-limit;
```

Hierarchy Level

```
[edit system services web-management session]
```

Description

Configure the maximum allowed number of concurrent web management sessions. Using the CLI, you can limit the number of concurrent sessions from 1 to 1024. Each session remains open for 24 hours (1440 minutes).

You can also set an idle time-out parameter to override the default to specify the length of time a session can be idle before it is terminated.

Options

`session-limit`

number

- **Default:** unlimited sessions
- **Range:** 1 to 1024 sessions

Required Privilege Level

`system`—To view this in the configuration.

`system-control`—To add this to the configuration.

Release Information

Statement introduced in Junos OS Release 9.0.

RELATED DOCUMENTATION

Firewall User Authentication Overview

Dynamic VPN Overview

source-port (Security Forwarding Options)

IN THIS SECTION

- [Syntax | 394](#)
- [Hierarchy Level | 394](#)
- [Description | 394](#)
- [Required Privilege Level | 398](#)

Syntax

```
source-port port-number;
```

Hierarchy Level

```
[edit security forwarding-options mirror-filter filter-name]
```

Description

Specify a Transmission Control Protocol (TCP) or User Datagram Protocol (UDP) source port number to be matched for mirroring. You can specify a numeric value or one of the text synonyms listed in [Table 21 on page 394](#).

Table 21: Ports Supported by Services Interfaces

Port Name	Corresponding Port Number
afs	1483
bgp	179
biff	512
bootpc	68

Table 21: Ports Supported by Services Interfaces (Continued)

Port Name	Corresponding Port Number
bootps	67
cmd	514
cvspserver	2401
dhcp	67
domain	53
eklogin	2105
ekshell	2106
excc	512
finger	79
ftp	21
ftp-data	20
http	80
https	443
ident	113
imap	143

Table 21: Ports Supported by Services Interfaces (Continued)

Port Name	Corresponding Port Number
kerberos-sec	88
klogin	543
kpasswd	761
krb-prop	754
krbupdate	760
kshell	544
ldap	389
ldp	646
login	513
mobileip-agent	434
mobileip-mn	435
msdp	639
netbios-dgm	138
netbios-ns	137
netbios-ssn	139

Table 21: Ports Supported by Services Interfaces (Continued)

Port Name	Corresponding Port Number
nfsd	2049
nntp	119
ntalk	518
ntp	123
pop3	110
pptp	1723
printer	515
radacct	1813
radius	1812
rip	520
rkinit	2108
smtp	25
snmp	161
snmp-trap	162
snpp	444

Table 21: Ports Supported by Services Interfaces (Continued)

Port Name	Corresponding Port Number
socks	1080
ssh	22
sunrpc	111
syslog	514
tacacs	49
tacacs-ds	65
talk	517
telnet	23
tftp	69
timed	525
who	513
xmcp	177

Required Privilege Level

security—To view this in the configuration.

security-control—To add this to the configuration.

Release Information

Statement introduced in Junos OS Release 12.1X46-D10.

RELATED DOCUMENTATION

[mirror-filter \(Security Forwarding Options\) | 345](#)

[show security forwarding-options mirror-filter | 819](#)

source-prefix (Security Forwarding Options)

IN THIS SECTION

- [Syntax | 399](#)
- [Hierarchy Level | 399](#)
- [Description | 400](#)
- [Required Privilege Level | 400](#)
- [Release Information | 400](#)

Syntax

```
source-prefix source-prefix;
```

Hierarchy Level

```
[edit security forwarding-options mirror-filter filter-name]
```

Description

Specify the source IP prefix or address to be matched for mirroring.

Required Privilege Level

security—To view this in the configuration.

security-control—To add this to the configuration.

Release Information

Statement introduced in Junos OS Release 12.1X46-D10.

RELATED DOCUMENTATION

[mirror-filter \(Security Forwarding Options\) | 345](#)

[show security forwarding-options mirror-filter | 819](#)

syn-flood-protection-mode

IN THIS SECTION

- [Syntax | 401](#)
- [Hierarchy Level | 401](#)
- [Description | 401](#)
- [Options | 401](#)
- [Required Privilege Level | 401](#)
- [Release Information | 401](#)

Syntax

```
syn-flood-protection-mode (syn-cookie | syn-proxy);
```

Hierarchy Level

```
[edit security flow]
```

Description

Enable SYN cookie or SYN proxy defenses against SYN attacks. SYN flood protection mode is enabled globally on the device and is activated when the configured `syn-flood attack-threshold` value is exceeded.

Options

- `syn-cookie`—Uses a cryptographic hash to generate a unique Initial Sequence Number (ISN). This is enabled by default.
- `syn-proxy`—Uses a proxy to handle the SYN attack.

Required Privilege Level

`security`—To view this in the configuration.

`security-control`—To add this to the configuration.

Release Information

Statement introduced in Junos OS Release 8.5; support.

tcp-initial-timeout

IN THIS SECTION

- [Syntax | 402](#)
- [Hierarchy Level | 402](#)
- [Description | 402](#)
- [Options | 403](#)
- [Required Privilege Level | 403](#)
- [Release Information | 403](#)

Syntax

```
tcp-initial-timeout seconds;
```

Hierarchy Level

```
[edit security flow tcp-session]
```

Description

Define the length of time (in seconds) that the device keeps an initial TCP session in the session table before dropping it, or until the device receives a FIN (no more data) or RST (reset) packet. The FIN flag indicates the end of data transmission to finish a TCP connection.

Options

seconds—Number of seconds that the device keeps an initial TCP session in the session table before dropping it.

- **Range:** 4 through 300 seconds
- **Default:** 20 seconds

NOTE: The minimum value you can configure for TCP session initialization is 4 seconds. The default value is 20 seconds; if required you can set the TCP session initialization value to less than 20 seconds.

Required Privilege Level

security—To view this in the configuration.

security-control—To add this to the configuration.

Release Information

Statement introduced in Junos OS Release 8.5.

RELATED DOCUMENTATION

[Understanding Traffic Processing on Security Devices | 2](#)

tcp-mss (Security Flow)

IN THIS SECTION

- [Syntax | 404](#)
- [Hierarchy Level | 404](#)
- [Description | 405](#)
- [Options | 405](#)
- [Required Privilege Level | 406](#)
- [Release Information | 406](#)

Syntax

```
tcp-mss {  
  all-tcp mss value;  
  gre-in {  
    mss value;  
  }  
  gre-out {  
    mss value;  
  }  
  ipsec-vpn {  
    mss value;  
  }  
}
```

Hierarchy Level

[edit security flow]

Description

Configure TCP maximum segment size (TCP MSS) for the following packet types:

- All TCP packets for network traffic.
- GRE packets entering the IPsec VPN tunnel.
- GRE packets exiting the IPsec VPN tunnel.
- TCP packets entering the IPsec VPN tunnel.

If all the four TCP MSS options are configured simultaneously, then the order of preference is as follows:

- If TCP packet enters an IPsec VPN tunnel, then an ipsec-vpn mss value has high priority over all-tcp mss value, hence ipsec-vpn mss value is set.
- If TCP packet enters GRE , then gre-in mss value overrides all-tcp mss value, hence gre-in mss value is set.
- If TCP packet exits GRE, then all-tcp mss value overrides gre-in mss value, hence all-tcp mss value is set.

TCP MSS may not override in GRE over IPsec (GREoIPsec) scenarios. Consequently, there may be more fragmentation in the network as GREoIPsec traffic isn't modified for TCP MSS. To ensure that TCP MSS works with GREoIPsec, set the priority of MSS applied to the TCP traffic in the following order (highest to lowest):

1. gre-in
2. gre-out based on direction of the GREoIPSec TCP traffic
3. ipsec-vpn for GREoIPsec
4. IPsec traffic
5. all-tcp for all the TCP traffic.

Options

The remaining statements are explained separately. See [CLI Explorer](#).

Required Privilege Level

security—To view this in the configuration.

security-control—To add this to the configuration.

Release Information

Statement introduced in Junos OS Release 8.5.

RELATED DOCUMENTATION

[all-tcp | 273](#)

[gre-in | 315](#)

[gre-out | 317](#)

[ipsec-vpn \(Security Flow\)](#)

[Understanding Traffic Processing on Security Devices | 2](#)

tcp-seq-ooo-window (Security Forwarding Options)

IN THIS SECTION

- [Syntax | 407](#)
- [Hierarchy Level | 407](#)
- [Description | 407](#)
- [Required Privilege Level | 407](#)
- [Release Information | 407](#)

Syntax

```
tcp-seq-ooo-window Kbytes;
```

Hierarchy Level

```
[edit security forwarding-options services-offload]
```

Description

Specify the TCP sequence out of order window threshold (Kbytes) for Service offload. The configured threshold range is from 0 Kbytes to 1023 Kbytes

Required Privilege Level

security—To view this statement in the configuration.

security-control—To add this statement to the configuration.

Release Information

Statement introduced in Junos OS Release 23.2R1

RELATED DOCUMENTATION

| [TCP Sessions](#) | 59

tcp-session

IN THIS SECTION

- [Syntax | 408](#)
- [Hierarchy Level | 408](#)
- [Description | 409](#)
- [Options | 409](#)
- [Required Privilege Level | 409](#)
- [Release Information | 409](#)

Syntax

```
tcp-session {  
    no-sequence-check;  
    no-syn-check;  
    no-syn-check-in-tunnel;  
    rst-invalidate-session;  
    rst-sequence-check;  
    strict-syn-check;  
    tcp-initial-timeout seconds;  
    time-wait-state {  
        (session-ageout | session-timeout seconds);  
    }  
}
```

Hierarchy Level

[edit security flow]

Description

Configure TCP session attributes:

- TCP sequence number checking.
- TCP SYN bit checking.
- Reset (RST) checking.
- Initial TCP session timeout—The minimum value you can configure for TCP session initialization is 4 seconds. The default value is 20 seconds; if required you can set the TCP session initialization value to less than 20 seconds.
- Strict TCP SYN checking.
- TCP session timeout for time-wait state.

Options

The remaining statements are explained separately. See [CLI Explorer](#).

Required Privilege Level

security—To view this in the configuration.

security-control—To add this to the configuration.

Release Information

Statement introduced in Junos OS Release 8.5.

RELATED DOCUMENTATION

[Understanding Traffic Processing on Security Devices](#) | 2

tcp-session-install-interval (Security Forwarding Options)

IN THIS SECTION

- [Syntax | 410](#)
- [Hierarchy Level | 410](#)
- [Description | 410](#)
- [Required Privilege Level | 411](#)
- [Release Information | 411](#)

Syntax

```
tcp-session-install-interval mseconds;
```

Hierarchy Level

```
[edit security forwarding-options services-offload]
```

Description

Specify the timeout value for TCP install NP session (mseconds). The configured interval range is from 50 msec to 30,000 msec.

Required Privilege Level

security—To view this statement in the configuration.

security-control—To add this statement to the configuration.

Release Information

Statement introduced in Junos OS Release 23.2R1

RELATED DOCUMENTATION

| [TCP Sessions](#) | 59

time-wait-state

IN THIS SECTION

- [Syntax](#) | 412
- [Hierarchy Level](#) | 412
- [Description](#) | 412
- [Options](#) | 412
- [Required Privilege Level](#) | 412
- [Release Information](#) | 413

Syntax

```
time-wait-state {  
    (session-ageout | session-timeout seconds);  
}
```

Hierarchy Level

```
[edit security flow tcp-session]
```

Description

Defines the length of time (in seconds) that the device keeps the defined TCP session in the session table. The default is 150 seconds.

Options

- `session-ageout`—Set a TCP session to age out, using the service based timeout value.
- `session-timeout seconds`—Set the session timeout value allowed before the device ages out a session from its session table.

Range: 2 through 600 seconds

Required Privilege Level

`security`—To view this in the configuration.

`security-control`—To add this to the configuration.

Release Information

Statement introduced in Junos OS Release 11.1.

RELATED DOCUMENTATION

[Understanding Traffic Processing on Security Devices](#) | 2

traceoptions (Security)

IN THIS SECTION

- [Syntax](#) | 413
- [Hierarchy Level](#) | 414
- [Description](#) | 414
- [Options](#) | 414
- [Required Privilege Level](#) | 415
- [Release Information](#) | 415

Syntax

```
traceoptions {
  file {
    filename;
    files number;
    match regular-expression;
    size maximum-file-size;
    (world-readable | no-world-readable);
  }
  flag flag;
  no-remote-trace;
```

```
rate-limit messages-per-second;  
}
```

Hierarchy Level

[edit security]

Description

Configure security tracing options.

Options

- `file`—Configure the trace file options.
 - `filename`—Name of the file to receive the output of the tracing operation. Enclose the name within quotation marks. All files are placed in the directory `/var/log`. By default, the name of the file is the name of the process being traced.
 - `files number`—Maximum number of trace files. When a trace file named `trace-file` reaches its maximum size, it is renamed to `trace-file.0`, then `trace-file.1`, and so on, until the maximum number of trace files is reached. The oldest archived file is overwritten.

If you specify a maximum number of files, you also must specify a maximum file size with the `size` option and a filename.

Range: 2 through 1000 files

Default: 10 files

- `match regular-expression`—Refine the output to include lines that contain the regular expression.
- `size maximum-file-size`—Maximum size of each trace file, in kilobytes (KB), megabytes (MB), or gigabytes (GB). When a trace file named `trace-file` reaches this size, it is renamed `trace-file.0`. When the `trace-file` again reaches its maximum size, `trace-file.0` is renamed `trace-file.1` and `trace-file` is renamed `trace-file.0`. This renaming scheme continues until the maximum number of trace files is reached. Then the oldest trace file is overwritten.

If you specify a maximum file size, you also must specify a maximum number of trace files with the `files` option and a filename.

Syntax: *x* *k* to specify KB, *x* *m* to specify MB, or *x* *g* to specify GB

Range: 10 KB through 1 GB

Default: 128 KB

- `world-readable` | `no-world-readable`—By default, log files can be accessed only by the user who configures the tracing operation. The `world-readable` option enables any user to read the file. To explicitly set the default behavior, use the `no-world-readable` option.
- `flag`—Trace operation to perform. To specify more than one trace operation, include multiple `flag` statements.
 - `all`—Trace all security events
 - `compilation`—Trace security compilation events
 - `configuration`—Trace security configuration events
 - `routing-socket`—Trace routing socket events
- `no-remote-trace`—Set remote tracing as disabled.
- `rate-limit` *messages-per-second*—Limit the incoming rate of trace messages.

Required Privilege Level

`trace`—To view this in the configuration.

`trace-control`—To add this to the configuration.

Release Information

Statement modified in Junos OS Release 8.5.

RELATED DOCUMENTATION

[Understanding Traffic Processing on Security Devices](#) | 2

traceoptions (Security Flow)

IN THIS SECTION

- [Syntax | 416](#)
- [Hierarchy Level | 417](#)
- [Description | 417](#)
- [Options | 417](#)
- [Required Privilege Level | 420](#)
- [Release Information | 421](#)

Syntax

```
traceoptions {
  file {
    filename;
    files number;
    match regular-expression;
    size maximum-file-size;
    (world-readable | no-world-readable);
  }
  flag {
    all;
    basic-datapath;
    fragmentation;
    high-availability;
    host-traffic;
    jexec;
    multicast;
    route;
    session;
    session-scan;
    tcp-basic;
    tunnel;
  }
}
```



```

no-remote-trace;
packet-filter filter-name {
    conn-tag session-conn
    destination-port port-identifier;
    destination-prefix address;
    interface interface-name;
    protocol protocol-identifier;
    source-port port-identifier;
    source-prefix address;
}
rate-limit messages-per-second;
trace-level (brief | detail | minimal);
}
root-override

```

Hierarchy Level

```

[edit security flow]
[edit logical-systems logical-system-name security flow]
[edit tenants tenant-name security flow]

```

Description

Configure flow tracing options.

Options

file	Configure the trace file options.
filename	Name of the file to receive the output of the tracing operation. Enclose the name within quotation marks. All files are placed in the directory <code>/var/log</code> . By default, the name of the file is the name of the process being traced.

files number Maximum number of trace files. When a trace file named *trace-file* reaches its maximum size, it is renamed to *trace-file.0*, then *trace-file.1*, and so on, until the maximum number of trace files is reached. The oldest archived file is overwritten.

If you specify a maximum number of files, you also must specify a maximum file size with the *size* option and a filename.

- **Range:** 2 through 1000 files
- **Default:** 10 files

match regular-expression Refine the output to include lines that contain the regular expression.

size maximum-file-size Maximum size of each trace file, in kilobytes (KB), megabytes (MB), or gigabytes (GB). When a trace file named *trace-file* reaches this size, it is renamed *trace-file.0*. When the *trace-file* again reaches its maximum size, *trace-file.0* is renamed *trace-file.1* and *trace-file* is renamed *trace-file.0*. This renaming scheme continues until the maximum number of trace files is reached. Then the oldest trace file is overwritten.

If you specify a maximum file size, you also must specify a maximum number of trace files with the *files* option and a filename.

Syntax: *x* **K** to specify KB, *x* **M** to specify MB, or *x* **G** to specify GB

- **Range:** 0 KB through 1 GB
- **Default:** 128 KB

world-readable | no-world-readable By default, log files can be accessed only by the user who configures the tracing operation. The *world-readable* option enables any user to read the file. To explicitly set the default behavior, use the *no-world-readable* option.

flag Trace operation to perform. To specify more than one trace operation, include multiple *flag* statements.

all Trace with all flags enabled

basic-datapath Trace basic packet flow activity

fragmentation Trace IP fragmentation and reassembly events

high-availability	Trace flow high-availability information
host-traffic	Trace flow host traffic information
jexec	Trace packet footprints
multicast	Trace multicast flow information
route	Trace route lookup information
session	Trace session creation and deletion events
session-scan	Trace session scan information
tcp-basic	Trace TCP packet flow information
tunnel	Trace tunnel information
no-remote-trace	Set remote tracing as disabled.
packet-filter <i>filter-name</i>	Packet filter to enable during the tracing operation. Configure the filtering options.
destination-port <i>port-identifier</i>	Match TCP/UDP destination port
destination-prefix <i>address</i>	Destination IP address prefix
interface <i>interface-name</i>	Logical interface
protocol <i>protocol-identifier</i>	Match IP protocol type
source-port <i>port-identifier</i>	Match TCP/UDP source port
source-prefix <i>address</i>	Source IP address prefix
rate-limit <i>messages-per-second</i>	Limit the incoming rate of trace messages.
trace-level	Set the level for trace logging. This option is available only when the flag is set.
brief	Trace key flow information, such as message types sent between SPU and central point, policy match, and packet drop reasons.
detail	Trace extensive flow information, such as detailed information about sessions and fragments. Detail is the default level.

minimal Trace messages including notice, warning, error, criticality, alert, and emergency.

root-override Root administrator can debug the packets flow traces from all the logical systems and tenant systems for debug by enabling the root-override option.

Table 22 on page 420 describes tracing of packet footprints with and without root override options.

Table 22: Logical System or Tenant System Tracing of Packet Footprints With and Without Root Override Options

Trace Configuration	With Root Override	Without Root Override
Logical systems and tenant systems with own flow trace configuration	The flow trace of logical systems and tenant systems are recorded to the root.	The flow trace of logical systems and tenant systems are recorded to the configured logical systems and tenant systems.
Logical systems and tenant systems without own flow trace configuration	The flow trace of logical systems and tenant systems are recorded to root.	The flow trace of logical systems and tenant systems are not recorded anywhere

When the packets are switched by the VPLS switch in root logical system, the jexec trace packet footprints might not be complete in logical systems and tenant systems.

If a logical system or tenant system does not configure the security flow trace options, and there is no root-override configured under root either, the packet traces will not be recorded.

To get complete packet footprints for logical systems and tenant systems related flow and jexec trace packet footprints, we recommend that you configure the required flow trace with root-override.

Required Privilege Level

trace—To view this in the configuration.

trace-control—To add this to the configuration.

Release Information

Statement introduced in Junos OS Release 8.5.

Statement updated in Junos OS Release 12.1X46-D10 with the trace-level option and additional flags.

Statement updated in Junos OS Release 15.1X49-D70 with the addition of the conn-tag filter parameter.

Support at the following hierarchy levels introduced in Junos OS Release 19.4R1: [edit logical-systems *logical-system-name* security flow], and [edit tenants *tenant-name* security flow].

Statement jexec, minimal, and root-override options are introduced in Junos OS Release 20.4R1. The option error is now changed to minimal.

RELATED DOCUMENTATION

[Understanding Traffic Processing on Security Devices | 2](#)

transport (Security Log)

IN THIS SECTION

- [Syntax | 421](#)
- [Hierarchy Level | 422](#)
- [Description | 422](#)
- [Options | 422](#)
- [Required Privilege Level | 423](#)
- [Release Information | 423](#)

Syntax

```
transport {  
    protocol (udp | tcp | tls);
```

```

tls-profile tls-profile-name;
tcp-connections tcp-connections;
}

```

Hierarchy Level

```

[edit security log]
[edit logical-systems name security log]
[edit tenants tenant-name security log]

```

Description

Configure security log transport options.

Options

protocol	Specify the type of transport protocol to be used to log the data. <ul style="list-style-type: none"> • UDP—Set the transport protocol to UDP. • TCP—Set the transport protocol to TCP. • TLS—Set the transport protocol to TLS. • Default: UDP.
tls-profile <i>tls-profile-name</i>	Specify the TLS profile name.
tcp-connections <i>tcp-connections</i>	Specify the number of TCP connections per SPU. <ul style="list-style-type: none"> • Range: 1 through 5. • Default: 1.

Required Privilege Level

security—To view this in the configuration.

security-control—To add this to the configuration.

Release Information

Statement introduced in Junos OS Release 12.1X46-D25.

The [edit logical-systems *name* security log] and [edit tenants *tenant-name* security log] hierarchy levels introduced in Junos OS Release 19.1R1.

RELATED DOCUMENTATION

| [Understanding AppTrack](#)

weight (Security)

IN THIS SECTION

- [Syntax | 423](#)
- [Hierarchy Level | 424](#)
- [Description | 424](#)
- [Required Privilege Level | 424](#)
- [Release Information | 425](#)

Syntax

```
weight (equal | firewall | idp);
```

Hierarchy Level

```
[edit security forwarding-process application-services maximize-idp-sessions]
```

Description

If you are deploying IDP policies, you can tune the device to increase IDP session capacity. By using the provided commands to change the way the system allocates resources, you can achieve a higher IDP session capacity.

Devices ship with an implicit default session capacity setting. This default value gives more weight to firewall sessions. You can manually override the default by using the `maximize-idp-sessions` command. The command allows you to choose between these weight values: `equal`, `firewall`, and `idp`. The following table displays the available session capacity weight and approximate throughput for each.

Table 23: Session Capacity and Resulting Throughput

Weight Value	Firewall Capacity	IDP Capacity	Firewall Throughput	IDP Throughput
Default	1,000,000	256,000	10 Gbps	2.4 Gbps
equal	1,000,000	1,000,000	8.5 Gbps	2 Gbps
firewall	1,000,000	1,000,000	10 Gbps	2.4 Gbps
idp	1,000,000	1,000,000	5.5 Gbps	1.4 Gbps

This statement is supported on SRX1500, SRX 5800, SRX 5600, and SRX 5400 devices and vSRX Virtual Firewall.

Required Privilege Level

security—To view this in the configuration.

security-control—To add this to the configuration.

Release Information

Statement introduced in Junos OS Release 9.6.

RELATED DOCUMENTATION

[Understanding Traffic Processing on Security Devices](#) | 2

7

CHAPTER

Operational Commands

- [clear firewall | 430](#)
- [clear monitor security flow filter | 432](#)
- [clear security flow ip-action | 433](#)
- [clear security flow session all | 437](#)
- [clear security flow session application | 439](#)
- [clear security flow session application-traffic-control | 442](#)
- [clear security flow session conn-tag | 446](#)
- [clear security flow session destination-port | 448](#)
- [clear security flow session destination-prefix | 450](#)
- [clear security flow session family | 453](#)
- [clear security flow session IDP | 455](#)
- [clear security flow session interface | 458](#)
- [clear security flow ip-action | 461](#)
- [clear security flow session nat | 464](#)
- [clear security flow session protocol | 467](#)
- [clear security flow session resource-manager | 470](#)
- [clear security flow session services-offload | 473](#)
- [clear security flow session session-identifier | 477](#)
- [clear security flow session source-port | 480](#)
- [clear security flow session source-prefix | 482](#)

clear security flow session tunnel | 485

clear security forward-options mirror filter | 488

monitor security flow file | 489

monitor security flow filter | 491

monitor security flow start | 494

monitor security flow stop | 495

monitor security packet-drop | 497

show chassis environment (Security) | 502

show chassis hardware (View) | 510

show chassis pic (Security) | 530

show chassis power | 533

show firewall (View) | 539

show interfaces (View Aggregated Ethernet) | 542

show interfaces flow-statistics | 558

show interfaces swfabx | 565

show monitor security flow | 567

show resource-manager cpu | 570

show resource-manager memory | 572

show resource-manager | 574

show security flow cp-session | 575

show security flow cp-session destination-port | 580

show security flow cp-session destination-prefix | 584

show security flow cp-session family | 588

show security flow cp-session protocol | 592

show security flow cp-session source-port | 596

show security flow cp-session source-prefix | 600

show security flow gate | 603

show security flow ip-action | 610

show security flow gate brief node | 622

show security flow gate destination-port | 630

show security flow gate destination-prefix | 635

show security flow gate protocol | 640

show security flow gate summary node | 645

show security flow pmi statistics | 652

show security flow session | 656

show security flow session brief node | 671

show security flow session destination-port | 677

show security flow session destination-prefix | 683

show security flow session extensive node | 689

show security flow session family | 699

show security flow session interface | 707

show security flow session nat | 713

show security flow session plugins | 719

show security flow session policy-id | 722

show security flow session pretty | 727

show security flow session protocol | 732

show security flow session resource-manager | 739

show security flow session services-offload | 745

show security flow session session-identifier | 753

show security flow session source-port | 760

show security flow session source-prefix | 766

show security flow session summary family | 772

show security flow session summary node | 776

show security flow session summary services-offload | 785

show security flow session tunnel | 790

show security flow statistics | 802

show security flow status | 808

show security forwarding-options mirror-filter | 819

show security forward-options resource-manager | 822

show security monitoring | 825

show security np-cache summary | 829

show security policies | 831

show security policies hit-count | 855

show security resource-manager group active | 862

show security resource-manager resource active | 867

show security resource-manager settings | 871

show security resource-manager summary | 874

show security screen ids-option | 876

show security screen statistics | 885

show security softwires | 901

show security zones | 903

show security zones type | 913

clear firewall

IN THIS SECTION

- [Syntax | 430](#)
- [Description | 430](#)
- [Options | 431](#)
- [Required Privilege Level | 431](#)
- [Output Fields | 431](#)
- [Sample Output | 431](#)
- [Release Information | 431](#)

Syntax

```
clear firewall
<all>
<counter counter-name>
<filter filter-name>
```

Description

Clear statistics about configured firewall filters.

NOTE: The `clear firewall` command cannot be used to clear the Routing Engine filter counters on a backup Routing Engine that is enabled for GRES.

If you clear statistics for firewall filters that are applied to Trio-based DPCs and that also use the `prefix-action` action on matched packets, wait at least 5 seconds before you enter the `show firewall prefix-action-stats` command. A 5-second pause between issuing the `clear firewall` and `show firewall prefix-action-stats` commands avoids a possible timeout of the `show firewall prefix-action-stats` command.

Options

all	Clear the packet and byte counts for all filters.
counter <i>counter-name</i>	Clear the packet and byte counts for a filter counter that has been configured with the counter firewall filter action.
filter <i>filter-name</i>	Clear the packet and byte counts for the specified firewall filter.

Required Privilege Level

clear

Output Fields

When you enter this command, you are provided feedback on the status of your request.

Sample Output

clear firewall all

```
user@host> clear firewall all
```

Release Information

Command introduced in Junos OS Release 10.0.

RELATED DOCUMENTATION

| [show firewall \(View\)](#)

clear monitor security flow filter

IN THIS SECTION

- [Syntax | 432](#)
- [Description | 432](#)
- [Options | 432](#)
- [Required Privilege Level | 433](#)
- [Output Fields | 433](#)
- [Sample Output | 433](#)
- [Release Information | 433](#)

Syntax

```
clear monitor security flow filter <filter-name>
```

Description

Specify the security flow filters to be deleted. Once deleted, the filters are removed from the Packet Forwarding Engine and the Routing Engine. .

NOTE: Specifying the filter name is optional. If no filter is specified, all filters are deleted.

Options

This command has no options.

Required Privilege Level

clear

Output Fields

When you enter this command, you are provided feedback on the status of your request.

Sample Output

Release Information

Command introduced in Junos OS Release 12.1X46-D10.

RELATED DOCUMENTATION

[Monitoring Security Flow Sessions Overview | 186](#)

[monitor security flow start | 494](#)

[monitor security flow filter | 491](#)

clear security flow ip-action

IN THIS SECTION

- [Syntax | 434](#)
- [Description | 434](#)
- [Options | 434](#)

- Required Privilege Level | 435
- Output Fields | 435
- Sample Output | 436
- Release Information | 436

Syntax

```
clear security flow ip-action [filter]
```

Description

Clear IP-action entries, based on filtered options, for IP sessions running on the device.

Options

filter—Filter the display based on the specified criteria.

The following filters display those sessions that match the criteria specified by the filter. Refer to the sample output for filtered output examples.

all | [*filter*]—All active sessions on the device.

destination-port *destination-port*—Destination port number of the traffic. Range is 1 through 65,535.

destination-prefix *destination-prefix*—Destination IP prefix or address.

family (inet | inet6) [*filter*]—IPv4 traffic or IPv6-NATPT traffic and filtered options.

logical-system *logical-system-name* | all [*filter*]—Specified logical system or all logical systems.

protocol *protocol-name* | *protocol-number* [*filter*]—Protocol name or number and filtered options.

- ah or 51
- egp or 8

- esp or 50
- gre or 47
- icmp or 1
- icmp6 or 58
- ipip or 4
- ospf or 89
- pim or 103
- rsvp or 46
- sctp or 132
- tcp or 6
- udp or 17

root-logical-system [*filter*]*—*Default logical system information and filtered options.

source-port *source-port**—*Source port number of the traffic. Range is 1 through 65,535.

source-prefix *source-prefix**—*Source IP prefix or address of the traffic.

Required Privilege Level

clear

Output Fields

When you enter this command, the system responds with the status of your request.

Sample Output

clear security flow ip-action all

```
user@host>clear security flow ip-action all
1008 ip-action entries cleared
```

clear security flow ip-action destination-prefix

```
user@host>clear security flow ip-action destination-prefix 192.0.2.5/24
87 ip-action entries cleared
```

clear security flow ip-action family inet

```
user@host>clear security flow ip-action family inet
2479 ip-action entries cleared
```

clear security flow ip-action protocol udp

```
user@host>clear security flow ip-action protocol udp
270 ip-action entries cleared
```

Release Information

Command introduced in Junos OS Release 10.4. Logical systems option introduced in Junos OS Release 11.2.

RELATED DOCUMENTATION

| [show security flow ip-action](#) | 610

clear security flow session all

IN THIS SECTION

- [Syntax | 437](#)
- [Description | 437](#)
- [Options | 437](#)
- [Required Privilege Level | 438](#)
- [Output Fields | 438](#)
- [Sample Output | 438](#)
- [Sample Output | 438](#)
- [Release Information | 439](#)

Syntax

```
clear security flow session all  
<node ( node-id | all | local | primary)>
```

Description

Clear all currently active security sessions on the device.

Options

- all—Clear information about all active sessions.
- node—(Optional) For chassis cluster configurations, clear all security sessions on a specific node (device) in the cluster.
 - *node-id* —Identification number of the node. It can be 0 or 1.

- `all` —Clear all nodes.
- `local` —Clear the local node.
- `primary`—Clear the primary node.

Required Privilege Level

`clear`

Output Fields

When you enter this command, you are provided feedback on the status of your request.

Sample Output

`clear security flow session all`

```
user@host> clear security flow session all
```

```
node0:
```

```
-----
```

```
1 active sessions cleared
```

```
node1:
```

```
-----
```

```
0 active sessions cleared
```

Sample Output

`clear security flow session all node 0`

```
user@host> clear security flow session all node 0
```

```
node0:
```

0 active sessions cleared

Release Information

Command introduced in Junos OS Release 8.5 ; `node` options added in Junos OS Release 9.0.

RELATED DOCUMENTATION

| [show security flow session](#) | 656

clear security flow session application

IN THIS SECTION

- [Syntax](#) | 440
- [Description](#) | 440
- [Options](#) | 440
- [Required Privilege Level](#) | 441
- [Output Fields](#) | 441
- [Sample Output](#) | 441
- [Sample Output](#) | 442
- [Release Information](#) | 442

Syntax

```
clear security flow session application
    application-name
<node ( node-id | all | local | primary)>
```

Description

Use this command to clear currently active sessions for application types or application sets.

Options

- *application-name* —Name of the specified application type or application set.
 - dns—Domain Name System
 - ftp—File Transfer Protocol
 - ignore—Ignore application type
 - mgcp-ca—Media Gateway Control Protocol with Call Agent
 - mgcp-ua—MGCP with User Agent
 - ms-rpc—Microsoft RPC
 - pptp—Point-to-Point Tunneling Protocol
 - q931—ISDN connection control protocol
 - ras—RAS
 - realaudio—RealAudio
 - rsh—UNIX remote shell services
 - rtsp—Real-Time Streaming Protocol
 - sccp—Skinny Client Control Protocol
 - sip—Session Initiation Protocol

- `sqlnet-v2`—Oracle SQLNET
- `sun-rpc`—Sun Microsystems RPC
- `talk`—TALK program
- `tftp`—Trivial File Transfer Protocol
- `node`—(Optional) For chassis cluster configurations, clear sessions for applications on a specific node (device) in the cluster.
 - `node-id` —Identification number of the node. It can be 0 or 1.
 - `all` —Clear all nodes.
 - `local` —Clear the local node.
 - `primary`—Clear the primary node.

Required Privilege Level

`clear`

Output Fields

When you enter this command, you are provided feedback on the status of your request.

Sample Output

`clear security flow session application dns`

```
user@host> clear security flow session application dns
node0:
-----
0 active sessions cleared
node1:
```

```
-----  
0 active sessions cleared
```

Sample Output

clear security flow session application dns node 0

```
user@host> clear security flow session application dns node 0  
node0:  
-----  
0 active sessions cleared
```

Release Information

Command introduced in Junos OS Release 8.5.

The node options added in Junos OS Release 9.0.

RELATED DOCUMENTATION

| *show security flow session application*

clear security flow session application-traffic-control

IN THIS SECTION

- [Syntax | 443](#)
- [Description | 443](#)
- [Options | 443](#)
- [Required Privilege Level | 445](#)

- [Output Fields | 445](#)
- [Sample Output | 445](#)
- [Release Information | 445](#)

Syntax

```
clear security flow session application-traffic-control [Enter] | application-traffic-control-session-options
```

Description

Clear all application traffic control sessions or the session associated with the specified option.

Application traffic control enables application-aware quality of service, as specified in the rules of the rules set defined for it.

Options

- | | |
|--------------------|---|
| application | Name of the application or application set. |
|--------------------|---|
- dns—Domain Name System
 - ftp—File Transfer Protocol
 - ignore—Ignore application type
 - mgcp-ca—Media Gateway Control Protocol with Call Agent
 - mgcp-ua—MGCP with User Agent
 - ms-rpc—Microsoft RPC
 - pptp—Point-to-Point Tunneling Protocol

- q931—ISDN connection control protocol
- ras—RAS
- realaudio—RealAudio
- rsh—UNIX remote shell services
- rtsp—Real-Time Streaming Protocol
- sccp—Skinny Client Control Protocol
- sip—Session Initiation Protocol
- sqlnet-v2—Oracle SQLNET
- sun-rpc—Sun Microsystems RPC
- talk—TALK program
- tftp—Trivial File Transfer Protocol

To display the supported applications list on an SRX Series device, enter the following command from configuration mode:

```
user@host# show groups junos-default applications
```

conn-tag

A 32-bit connection tag that uniquely identifies the GPRS tunneling protocol, user plane (GTP-U), and the Stream Control Transmission Protocol (SCTP) sessions.

The connection tag for GTP-U is the tunnel endpoint identifier (TEID). For SCTP, it is the vTag. The connection ID remains 0 if the connection tag is not used by the sessions.

- **Range:** 0 through 4294967295

destination-port

Destination port.

- **Range:** 1 through 65535.

destination-prefix

Destination IP prefix or address.

family

Protocol family:

- inet—Clear IPv4 sessions.

- `inet6`—Clear IPv6 sessions.

interface	Name of incoming or outgoing interface.
protocol	IP protocol number.
source-port	Source port. <ul style="list-style-type: none">• Range: 1 through 65535.
source-prefix	Source IP prefix or address.

Required Privilege Level

clear

Output Fields

When you enter this command, you are provided feedback on the status of your request.

The same output is displayed when you enter an option for this command.

Sample Output

command-name

```
user@host> clear security flow session application-traffic-control
number active sessions cleared
```

Release Information

Command introduced in Junos OS Release 11.4.

RELATED DOCUMENTATION

| [show security flow session](#) | 656

clear security flow session conn-tag

IN THIS SECTION

- [Syntax](#) | 446
- [Description](#) | 446
- [Options](#) | 447
- [Required Privilege Level](#) | 447
- [Output Fields](#) | 447
- [Sample Output](#) | 447
- [Release Information](#) | 448

Syntax

```
clear security flow session conn-tag conn-tag-id-number
```

Description

Clear the session identified by the session connection (conn-tag) identification tag.

The flow session connection tag allows you to add a filter to further distinguish GRSP tunneling protocol, user plane (GTP-U) flow sessions, and Stream Control Transmission Protocol (SCTP) flow sessions.

Options

conn-tag A 32-bit connection tag that uniquely identifies the GPRS tunneling protocol, user plane (GTP-U) and the Stream Control Transmission Protocol (SCTP) sessions. The connection tag for GTP-U is the tunnel endpoint identifier (TEID) and for SCTP is the vTag. The connection ID remains 0 if the connection tag is not used by the sessions.

You can configure the system to include the session connection tag tuple to identify GTP-U session and SCTP sessions by adding the session connection tag to the standard six tuples that identify a session. The system determines the DCP for GTP-U/SCTP by hashing the session connection tag.

The central point architecture distributes GTP-U traffic handled by a gateway GPRS support node (GGSN) and SGSN pair on all SPUs by switching to tunnel endpoint identifier (TEID)-based hash distribution. To handle load-balancing issues, tag-based hash distribution is used to ensure even distribution of SCTP traffic from different associations among all SPUs. (The connection tag for GTP-U is the TEID and for SCTP is the vTag.)

- **Range:** 0 through 4294967295.

Required Privilege Level

clear

Output Fields

When you enter this command, you are provided feedback on the status of your request.

Sample Output

command-name

```
user@host> clear-security-flow-session conn-tag conn-tag-id-number  
number active sessions cleared
```

Release Information

Command introduced in Junos OS Release 15.1X49-D40.

clear security flow session destination-port

IN THIS SECTION

- [Syntax | 448](#)
- [Description | 448](#)
- [Options | 449](#)
- [Required Privilege Level | 449](#)
- [Output Fields | 449](#)
- [Sample Output | 449](#)
- [Sample Output | 450](#)
- [Release Information | 450](#)

Syntax

```
clear security flow session destination-port
    destination-port-number
<node ( node-id | all | local | primary)>
```

Description

Clear each session that uses the specified destination port

Options

- *destination-port-number* —Number of the destination port.
- *node*—(Optional) For chassis cluster configurations, clear security sessions on the port on a specific node (device) in the cluster.
 - *node-id* —Identification number of the node. It can be 0 or 1.
 - *all* —Clear all nodes.
 - *local* —Clear the local node.
 - *primary*—Clear the primary node.

Required Privilege Level

clear

Output Fields

When you enter this command, you are provided feedback on the status of your request.

Sample Output

clear security flow session destination-port 1

```
user@host> clear security flow session destination-port 1
node0:
-----
0 active sessions cleared
node1:
-----
0 active sessions cleared
```

Sample Output

clear security flow session destination-port 1 node 0

```
user@host> clear security flow session destination-port 1 node 0
node0:
-----
0 active sessions cleared
```

Release Information

Command introduced in Junos OS Release 8.5 ; node options added in Junos OS Release 9.0.

RELATED DOCUMENTATION

| [show security flow session destination-port](#) | [677](#)

clear security flow session destination-prefix

IN THIS SECTION

- [Syntax](#) | [451](#)
- [Description](#) | [451](#)
- [Options](#) | [451](#)
- [Required Privilege Level](#) | [451](#)
- [Output Fields](#) | [451](#)
- [Sample Output](#) | [452](#)
- [Sample Output](#) | [452](#)
- [Release Information](#) | [452](#)

Syntax

```
clear security flow session destination-prefix
    destination-IP-prefix
<node ( node-id | all | local | primary)>
```

Description

Clear sessions that match this destination IP prefix or address.

Options

- *destination-IP-prefix*—Destination IP prefix or address.
- *node*—(Optional) For chassis cluster configurations, clear sessions that match the IP prefix or address on a specific node (device) in the cluster.
 - *node-id*—Identification number of the node. It can be 0 or 1.
 - *all*—Clear all nodes.
 - *local*—Clear the local node.
 - *primary*—Clear the primary node.

Required Privilege Level

clear

Output Fields

When you enter this command, you are provided feedback on the status of your request.

Sample Output

clear security flow session destination-prefix 100.0.0.1

```
clear security flow session destination-prefix 100.0.0.1
node0:
-----
0 active sessions cleared
node1:
-----
0 active sessions cleared
```

clear security flow session destination-prefix 10::10

```
user@host> clear security flow session destination-prefix 10::10
1 active sessions cleared
```

Sample Output

Clear security flow session destination-prefix 100.0.0.1 node 0

```
user@host> clear security flow session destination-prefix 100.0.0.1 node 0
node0:
-----
0 active sessions cleared
```

Release Information

Command introduced in Release 8.5 of Junos OS.

The node options added in Release 9.0 of Junos OS.

Support for IPv6 addresses added in Release 10.2 of Junos OS.

RELATED DOCUMENTATION

| [show security flow session destination-prefix](#) | 683

clear security flow session family

IN THIS SECTION

- [Syntax](#) | 453
- [Description](#) | 453
- [Options](#) | 453
- [Required Privilege Level](#) | 454
- [Output Fields](#) | 454
- [Sample Output](#) | 454
- [Release Information](#) | 454

Syntax

```
clear security flow session family (inet | inet6)
```

Description

Clear sessions that match the specified protocol family.

Options

- `inet`—Clear IPv4 sessions.
- `inet6`—Clear IPv6 sessions.

Required Privilege Level

clear

Output Fields

When you enter this command, you are provided feedback on the status of your request.

Sample Output

clear security flow session family inet

```
user@host> clear security flow session family inet
1 active sessions cleared
```

clear security flow session family inet6

```
user@host> clear security flow session family inet6
1 active sessions cleared
```

Release Information

Command introduced in Junos OS Release 10.2.

RELATED DOCUMENTATION

| [show security flow session family](#) | 699

clear security flow session IDP

IN THIS SECTION

- [Syntax | 455](#)
- [Description | 455](#)
- [Options | 455](#)
- [Required Privilege Level | 457](#)
- [Output Fields | 457](#)
- [Sample Output | 458](#)
- [Release Information | 458](#)

Syntax

```
clear security flow session IDP [Enter] | idp-session-parameters
```

Description

Clear all active Intrusion Detection and Prevention (IDP) sessions or an IDP session based on the specified session parameter.

IDP allows you to enforce various attack detection and prevention techniques on network traffic passing through the SRX Series Firewall. The SRX Series offers the same set of IDP signatures that are available on Juniper Networks IDP Series Intrusion Detection and Prevention Appliances to secure networks against attacks.

Options

application Name of the application or application set.

- dns—Domain Name System
- ftp—File Transfer Protocol
- ignore—Ignore application type
- mgcp-ca—Media Gateway Control Protocol with Call Agent
- mgcp-ua—MGCP with User Agent
- ms-rpc—Microsoft RPC
- pptp—Point-to-Point Tunneling Protocol
- q931—ISDN connection control protocol
- ras—RAS
- realaudio—RealAudio
- rsh—UNIX remote shell services
- rtsp—Real-Time Streaming Protocol
- sccp—Skinny Client Control Protocol
- sip—Session Initiation Protocol
- sqlnet-v2—Oracle SQLNET
- sun-rpc—Sun Microsystems RPC
- talk—TALK program
- tftp—Trivial File Transfer Protocol

To display the supported applications list on an SRX Series Firewall, enter the following command from configuration mode:

```
user@host# show groups junos-default applications
```

conn-tag

A 32-bit connection tag that uniquely identifies the GPRS tunneling protocol, user plane (GTP-U), and the Stream Control Transmission Protocol (SCTP) sessions.

The connection tag for GTP-U is the tunnel endpoint identifier (TEID). For SCTP, it is the vTag. The connection ID remains 0 if the connection tag is not used by the sessions.

	<ul style="list-style-type: none"> • Range: 0 through 4294967295
destination-port	Destination port. <ul style="list-style-type: none"> • Range: 1 through 65535.
destination-prefix	Destination IP prefix or IP address.
family	Protocol family: <ul style="list-style-type: none"> • inet—Clear IPv4 sessions. • inet6—Clear IPv6 sessions.
interface	Name of incoming or outgoing interface.
protocol	IP protocol number.
source-port	Source port. <ul style="list-style-type: none"> • Range: 1 through 65535.
source-prefix	Source IP prefix or address.

Required Privilege Level

clear

Output Fields

When you enter this command, you are provided feedback on the status of your request.

The same output is displayed when you enter an option for this command.

Sample Output

command-name

```
user@host> clear security flow session idp
number active sessions cleared
```

Release Information

Command introduced in Junos OS Release 10.2.

RELATED DOCUMENTATION

| [show security flow session](#) | 656

clear security flow session interface

IN THIS SECTION

- [Syntax](#) | 459
- [Description](#) | 459
- [Options](#) | 459
- [Required Privilege Level](#) | 459
- [Output Fields](#) | 459
- [Sample Output](#) | 460
- [Sample Output](#) | 460
- [Release Information](#) | 460

Syntax

```
clear security flow session interface
    interface-name
<node ( node-id | all | local | primary)>
```

Description

Clear sessions that use the specified interface.

Options

- *interface-name* —Name of a specific incoming or outgoing interface.
- *node*—(Optional) For chassis cluster configurations, clear security sessions on the interface on a specific node (device) in the cluster.
 - *node-id* —Identification number of the node. It can be 0 or 1.
 - *all* —Clear all nodes.
 - *local* —Clear the local node.
 - *primary*—Clear the primary node.

Required Privilege Level

clear

Output Fields

When you enter this command, you are provided feedback on the status of your request.

Sample Output

clear security flow session interface ge-0/0/0.0

```
user@host> clear security flow session interface ge-0/0/0.0
node0:
-----
0 active sessions cleared
node1:
-----
0 active sessions cleared
```

Sample Output

clear security flow session interface ge/0/0.0 node 0

```
user@host> clear security flow session interface ge-0/0/0.0 node 0
node0:
-----
0 active sessions cleared
```

Release Information

Command introduced in Junos OS Release 8.5; node options added in Junos OS Release 9.0.

RELATED DOCUMENTATION

| [show security flow session interface](#) | 707

clear security flow ip-action

IN THIS SECTION

- [Syntax | 461](#)
- [Description | 461](#)
- [Options | 461](#)
- [Required Privilege Level | 462](#)
- [Output Fields | 463](#)
- [Sample Output | 463](#)
- [Release Information | 463](#)

Syntax

```
clear security flow ip-action [filter]
```

Description

Clear IP-action entries, based on filtered options, for IP sessions running on the device.

Options

filter—Filter the display based on the specified criteria.

The following filters display those sessions that match the criteria specified by the filter. Refer to the sample output for filtered output examples.

all | [*filter*]*—All active sessions on the device.*

destination-port *destination-port*—Destination port number of the traffic. Range is 1 through 65,535.

destination-prefix *destination-prefix*—Destination IP prefix or address.

family (inet | inet6) [*filter*]—IPv4 traffic or IPv6-NATPT traffic and filtered options.

logical-system *logical-system-name* | all [*filter*]—Specified logical system or all logical systems.

protocol *protocol-name* | *protocol-number* [*filter*]—Protocol name or number and filtered options.

- ah or 51
- egp or 8
- esp or 50
- gre or 47
- icmp or 1
- icmp6 or 58
- ipip or 4
- ospf or 89
- pim or 103
- rsvp or 46
- sctp or 132
- tcp or 6
- udp or 17

root-logical-system [*filter*]—Default logical system information and filtered options.

source-port *source-port*—Source port number of the traffic. Range is 1 through 65,535.

source-prefix *source-prefix*—Source IP prefix or address of the traffic.

Required Privilege Level

clear

Output Fields

When you enter this command, the system responds with the status of your request.

Sample Output

clear security flow ip-action all

```
user@host>clear security flow ip-action all
1008 ip-action entries cleared
```

clear security flow ip-action destination-prefix

```
user@host>clear security flow ip-action destination-prefix 192.0.2.5/24
87 ip-action entries cleared
```

clear security flow ip-action family inet

```
user@host>clear security flow ip-action family inet
2479 ip-action entries cleared
```

clear security flow ip-action protocol udp

```
user@host>clear security flow ip-action protocol udp
270 ip-action entries cleared
```

Release Information

Command introduced in Junos OS Release 10.4. Logical systems option introduced in Junos OS Release 11.2.

RELATED DOCUMENTATION

| [show security flow ip-action](#) | [610](#)

clear security flow session nat

IN THIS SECTION

- [Syntax](#) | [464](#)
- [Description](#) | [464](#)
- [Options](#) | [465](#)
- [Required Privilege Level](#) | [466](#)
- [Output Fields](#) | [467](#)
- [Sample Output](#) | [467](#)
- [Release Information](#) | [467](#)

Syntax

```
clear security flow session nat <Enter> | nat-session-parameter
```

Description

Clear all active sessions with NAT configurations or the active NAT session identified by a session parameter.

Network Address Translation (NAT) is now used primarily to improve traffic security. But it also offers solutions to IP address constraints prior to the advent and implementation of IPv6. NAT allows you to remap one IP address space to another. Network address information in the IP datagram packet headers are modified to achieve the translation.

Options

application

Name of the application protocol

- dns—Domain Name System
- ftp—File Transfer Protocol
- ignore—Ignore application type
- mgcp-ca—Media Gateway Control Protocol with Call Agent
- mgcp-ua—MGCP with User Agent
- ms-rpc—Microsoft RPC
- pptp—Point-to-Point Tunneling Protocol
- q931—ISDN connection control protocol
- ras—RAS
- realaudio—RealAudio
- rsh—UNIX remote shell services
- rtsp—Real-Time Streaming Protocol
- sccp—Skinny Client Control Protocol
- sip—Session Initiation Protocol
- sqlnet-v2—Oracle SQLNET
- sun-rpc—Sun Microsystems RPC
- talk—TALK program
- tftp—Trivial File Transfer Protocol

To display a list of the supported applications on an SRX Series device, enter the following command from configuration mode:

```
user@host# show groups junos-default applications
```

conn-tag

Session identified by the specified conn-tag.

A conn-tag is a 32-bit connection tag that uniquely identifies the GPRS tunneling protocol, user plane (GTP-U), and the Stream Control Transmission Protocol (SCTP) sessions.

The connection tag for GTP-U is the tunnel endpoint identifier (TEID). For SCTP, it is the vTag. The connection ID remains 0 if the connection tag is not used by the sessions.

Session connection identifiers are in the following range:

- **Range:** 0 through 4294967295

destination-port	Destination port.
	<ul style="list-style-type: none"> • Range: 1 through 65535
destination-prefix	Destination IP prefix or address.
family	Protocol family:
	<ul style="list-style-type: none"> • inet—Clear IPv4 sessions • inet6—Clear IPv6 sessions
interface	Name of incoming or outgoing interface.
protocol	IP protocol number.
source-port	Source port.
	<ul style="list-style-type: none"> • Range: 1 through 65535.
source-prefix	Source IP prefix or IP address.

Required Privilege Level

clear

Output Fields

Displays a message reporting the number of active sessions cleared. The same message is displayed when any specific option is entered.

Sample Output

command-name

```
user@host> clear security flow session nat
number active sessions cleared
```

Release Information

Command introduced in Junos OS Release 10.2.

RELATED DOCUMENTATION

| [show security flow session](#) | [656](#)

clear security flow session protocol

IN THIS SECTION

- [Syntax](#) | [468](#)
- [Description](#) | [468](#)
- [Options](#) | [468](#)
- [Required Privilege Level](#) | [469](#)
- [Output Fields](#) | [469](#)

- [Sample Output | 469](#)
- [Sample Output | 470](#)
- [Release Information | 470](#)

Syntax

```
clear security flow session protocol protocol-name | protocol-
number
<node ( node-id | all | local | primary)>
```

Description

Clear each session that uses the specified IP protocol.

Options

- *protocol-name* — (Optional) Networking protocol name. The following text values are supported.
 - ah—IP Security Authentication Header
 - egp—Exterior gateway protocol
 - esp—IPsec Encapsulating Security Payload
 - gre—Generic routing encapsulation
 - icmp—Internet Control Message Protocol
 - igmp—Internet Group Management Protocol
 - ipip—IP over IP
 - ospf—Open Shortest Path First
 - pim—Protocol Independent Multicast

- rsvp—Resource Reservation Protocol
- sctp—Stream Control Transmission Protocol
- tcp—Transmission Control Protocol
- udp—User Datagram Protocol
- *protocol-number* —(Optional) Numeric protocol value. For a complete list of possible numeric values, see RFC 1700, *Assigned Numbers (for the Internet Protocol Suite)*.

Range: 0 through 255

- *node*—(Optional) For chassis cluster configurations, clear security on a specific node (device) in the cluster for the user with this identification number.
 - *node-id* —Identification number of the node. It can be 0 or 1.
 - all —Clear all nodes.
 - local —Clear the local node.
 - primary—Clear the primary node.

Required Privilege Level

clear

Output Fields

When you enter this command, you are provided feedback on the status of your request.

Sample Output

clear security flow session protocol pim

```
user@host> clear security flow session protocol pim
node0:
```

```
-----
```

```
0 active sessions cleared
node1:
-----
0 active sessions cleared
```

Sample Output

clear security flow session protocol 0

```
user@host> clear security flow session protocol 0
node0:
-----
0 active sessions cleared
node1:
-----
0 active sessions cleared
```

Release Information

Command introduced in Junos OS Release 8.5 ; node options added in Junos OS Release 9.0.

RELATED DOCUMENTATION

| [show security flow session protocol](#) | [732](#)

clear security flow session resource-manager

IN THIS SECTION

● [Syntax](#) | [471](#)

- [Description | 471](#)
- [Options | 471](#)
- [Required Privilege Level | 472](#)
- [Output Fields | 472](#)
- [Sample Output | 472](#)
- [Sample Output | 472](#)
- [Release Information | 473](#)

Syntax

```
clear security flow session resource-manager  
<node ( node-id | all | local | primary)>
```

Description

Clear resource-manager sessions.

Options

- *node*—(Optional) For chassis cluster configurations, clear the resource manager sessions on a specific node (device) in the cluster.
 - *node-id* —Identification number of the node. It can be 0 or 1.
 - *all* —Clear all nodes.
 - *local* —Clear the local node.
 - *primary*—Clear the primary node.

Required Privilege Level

clear

Output Fields

When you enter this command, you are provided feedback on the status of your request.

Sample Output

clear security flow session resource-manager

```
user@host> clear security flow session resource-manager
node0:
-----
0 active sessions cleared
node1:
-----
0 active sessions cleared
```

Sample Output

clear security flow session resource-manager node 0

```
user@host> clear security flow session resource-manager node 0
node0:
-----
0 active sessions cleared
```

Release Information

Command introduced in Junos OS Release 8.5; `node` options added in Junos OS Release 9.0.

RELATED DOCUMENTATION

| [show security flow session resource-manager](#) | 739

clear security flow session services-offload

IN THIS SECTION

- [Syntax](#) | 473
- [Description](#) | 473
- [Options](#) | 474
- [Required Privilege Level](#) | 475
- [Output Fields](#) | 475
- [Sample Output](#) | 475
- [Release Information](#) | 477

Syntax

```
clear security flow session services-offload [filter]
```

Description

Clear services-offload security sessions, based on filtered options, on the device. This command also clears a services-offload security session from both the network processor and the Services Processing Unit (SPU) on which the specified session was installed.

Options

filter—Filter the display based on the specified criteria.

The following filters clear those sessions that match the criteria specified by the filter. Refer to the sample output for filtered output examples.

application *application-name*—Application name.

destination-port *destination-port*—Destination port number. Range is from 1 through 65,535.

destination-prefix *destination-prefix*—Destination IP prefix or address.

family (inet | inet6)—IPv4 traffic or IPv6-NAT-PT traffic.

interface *interface-name*—Incoming or outgoing interface name.

logical-system *logical-system-name* | all—Specified logical system name or all logical systems.

protocol *protocol-name* | *protocol-number* —Protocol name or number.

- ah or 51
- egp or 8
- esp or 50
- gre or 47
- icmp or 1
- icmp6 or 58
- igmp or 2
- ipip or 4
- ospf or 89
- pim or 103
- rsvp or 46
- sctp or 132
- tcp or 6
- udp or 17

root-logical-system [*filter*]—Root logical system information and filtered options.

`source-port` *source-port*—Source port number of the traffic. Range is from 1 through 65,535.

`source-prefix` *source-prefix*—Source IP prefix or address of the traffic.

Required Privilege Level

clear

Output Fields

When you enter this command, you are provided feedback on the status of your request.

Sample Output

clear security flow session services-offload

```
user@host>clear security flow session services-offload
0 active sessions cleared
```

clear security flow session services-offload application

```
user@host>clear security flow session services-offload dns
0 active sessions cleared
```

clear security flow session services-offload destination-port

```
user@host>clear security flow session services-offload destination-port 1
0 active sessions cleared
```

clear security flow session services-offload destination-prefix

```
user@host>clear security flow session services-offload destination-prefix 10.0.0.1
0 active sessions cleared
```

clear security flow session services-offload family

```
user@host>clear security flow session services-offload family inet
1 active sessions cleared
```

clear security flow session services-offload interface

```
user@host>clear security flow session services-offload interface ge-0/0/0.0
0 active sessions cleared
```

clear security flow session services-offload logical-system

```
user@host>clear security flow session services-offload logical-system all
0 active sessions cleared
```

clear security flow session services-offload protocol

```
user@host>clear security flow session services-offload protocol pim
0 active sessions cleared
```

clear security flow session services-offload root-logical-system

```
user@host>clear security flow session services-offload root-logical-system application dns
0 active sessions cleared
```

clear security flow session services-offload source-port

```
user@host>clear security flow session services-offload source-port 1
0 active sessions cleared
```

clear security flow session services-offload source-prefix

```
user@host>clear security flow session services-offload source-prefix 10.0.0.1
0 active sessions cleared
```

Release Information

Command introduced in Junos OS Release 11.4.

Starting with Junos OS Release 15.1X49-D10 and Junos OS Release 17.3R1, the SRX5K-MPC3-100G10G (IOC3) and the SRX5K-MPC3-40G10G (IOC3) with Express Path (formerly known as *services offloading*) support are introduced for SRX5400, SRX5600, and SRX5800 devices.

RELATED DOCUMENTATION

[show security flow session services-offload](#) | 745

clear security flow session session-identifier

IN THIS SECTION

- [Syntax](#) | 478
- [Description](#) | 478
- [Options](#) | 478
- [Required Privilege Level](#) | 478
- [Output Fields](#) | 479

- [Sample Output | 479](#)
- [Sample Output | 479](#)
- [Release Information | 479](#)

Syntax

```
clear security flow session session-identifier
                               session-identifier
<node ( node-id | all | local | primary)>
```

Description

Clear the session with the specific identifier.

Options

- *session-identifier*—Number from 1 through 4,294,967,295 that identifies the security session.
- *node*—(Optional) For chassis cluster configurations, clear the specified session on a specific node (device) in the cluster.
 - *node-id*—Identification number of the node. It can be 0 or 1.
 - *all*—Clear all nodes.
 - *local*—Clear the local node.
 - *primary*—Clear the primary node.

Required Privilege Level

clear

Output Fields

When you enter this command, you are provided feedback on the status of your request.

Sample Output

clear security flow session session-identifier 1

```
user@host> clear security flow session session-identifier 1
0 active sessions cleared
```

Sample Output

clear security flow session session-identifier 1 node 0

```
user@host> clear security flow session session-identifier 1 node 0
node0:
-----
0 active sessions cleared
```

Release Information

Command introduced in Junos OS Release 8.5; node options added in Junos OS Release 9.0.

RELATED DOCUMENTATION

| [show security flow session session-identifier](#) | 753

clear security flow session source-port

IN THIS SECTION

- [Syntax | 480](#)
- [Description | 480](#)
- [Options | 480](#)
- [Required Privilege Level | 481](#)
- [Output Fields | 481](#)
- [Sample Output | 481](#)
- [Sample Output | 482](#)
- [Release Information | 482](#)

Syntax

```
clear security flow session source-port
                               source-port-number
<node ( node-id | all | local | primary)>
```

Description

Clear each session that uses the specified source port.

Options

- *source-port-number* —Number that identifies the source port.

Range: 1 through 65,535

- `node`—(Optional) For chassis cluster configurations, clear sessions on the specified source port on a specific node (device) in the cluster.
 - `node-id` —Identification number of the node. It can be 0 or 1.
 - `all` —Clear all nodes.
 - `local` —Clear the local node.
 - `primary`—Clear the primary node.

Required Privilege Level

clear

Output Fields

When you enter this command, you are provided feedback on the status of your request.

Sample Output

clear security flow session source-port 1

```
user@host> clear security flow session source-port 1
node0:
-----
0 active sessions cleared
node1:
-----
0 active sessions cleared
```

Sample Output

clear security flow session source-port 1 node 0

```
user@host> clear security flow session source-port 1 node 0
node0:
-----
0 active sessions cleared
```

Release Information

Command introduced in Junos OS Release 8.5; node options added in Junos OS Release 9.0.

RELATED DOCUMENTATION

| [show security flow session source-port](#) | [760](#)

clear security flow session source-prefix

IN THIS SECTION

- [Syntax](#) | [483](#)
- [Description](#) | [483](#)
- [Options](#) | [483](#)
- [Required Privilege Level](#) | [483](#)
- [Output Fields](#) | [483](#)
- [Sample Output](#) | [484](#)
- [Sample Output](#) | [484](#)
- [Release Information](#) | [484](#)

Syntax

```
clear security flow session source-prefix
    source-prefix-number
<node ( node-id | all | local | primary)>
```

Description

Clear sessions that match the source prefix.

Options

- *source-prefix-number*—Source IP prefix or address.
- *node*—(Optional) For chassis cluster configurations, clear security sessions matching the source prefix on a specific node (device) in the cluster.
 - *node-id*—Identification number of the node. It can be 0 or 1.
 - *all*—Clear all nodes.
 - *local*—Clear the local node.
 - *primary*—Clear the primary node.

Required Privilege Level

clear

Output Fields

When you enter this command, you are provided feedback on the status of your request.

Sample Output

clear security flow session source-prefix 10.0.0.1

```
user@host> clear security flow session source-prefix 10.0.0.1
node0:
-----
0 active sessions cleared
node1:
-----
0 active sessions cleared
```

clear security flow session source-prefix 10::10

```
user@host> clear security flow session source-prefix 10::10
1 active sessions cleared
```

Sample Output

clear security flow session source-prefix 10.0.0.1 node 0

```
user@host> clear security flow session source-prefix 10.0.0.1 node 0
node0:
-----
0 active sessions cleared
```

Release Information

Command introduced in Release 8.5 of Junos OS.

The node options added in Release 9.0 of Junos OS.

Support for IPv6 addresses added in Release 10.2 of Junos OS.

RELATED DOCUMENTATION

| [show security flow session source-prefix](#) | [766](#)

clear security flow session tunnel

IN THIS SECTION

- [Syntax](#) | [485](#)
- [Description](#) | [485](#)
- [Options](#) | [485](#)
- [Required Privilege Level](#) | [487](#)
- [Output Fields](#) | [487](#)
- [Sample Output](#) | [487](#)
- [Release Information](#) | [488](#)

Syntax

```
clear security flow session tunnel [Enter] | tunnel-session-parameters
```

Description

Clear all active tunnel sessions by entering the command without parameters, or clear the tunnel session whose session parameters are specified.

Options

application Name of the application or application set.

- dns—Domain Name System
- ftp—File Transfer Protocol
- ignore—Ignore application type
- mgcp-ca—Media Gateway Control Protocol with Call Agent
- mgcp-ua—MGCP with User Agent
- ms-rpc—Microsoft RPC
- pptp—Point-to-Point Tunneling Protocol
- q931—ISDN connection control protocol
- ras—RAS
- realaudio—RealAudio
- rsh—UNIX remote shell services
- rtsp—Real-Time Streaming Protocol
- sccp—Skinny Client Control Protocol
- sip—Session Initiation Protocol
- sqlnet-v2—Oracle SQLNET
- sun-rpc—Sun Microsystems RPC
- talk—TALK program
- tftp—Trivial File Transfer Protocol

To display the supported applications list on an SRX Series device, enter the following command from configuration mode:

```
user@host# show groups junos-default applications
```

- conn-tag** session connection identifiers are in the following range:
- **Range:** 0 through 4294967295
- destination-port** Destination port.

- **Range:** 1 through 65535

destination-prefix	Destination IP prefix or address.
family	Protocol family: <ul style="list-style-type: none">• inet—Clear IPv4 sessions• inet6—Clear IPv6 sessions
interface	Name of incoming or outgoing interface.
protocol	IP protocol number.
source-port	Source port. <ul style="list-style-type: none">• Range: 1 through 65535.
source-prefix	Source IP prefix or address.

Required Privilege Level

clear

Output Fields

When you enter this command, you are provided feedback on the status of your request.

The same output is displayed when you enter an option for this command.

Sample Output

command-name

```
user@host> clear security flow session tunnel
number active sessions cleared
```

Release Information

Command introduced in Junos OS Release 8.5.

clear security forward-options mirror filter

IN THIS SECTION

- [Syntax | 488](#)
- [Description | 488](#)
- [Options | 488](#)
- [Required Privilege Level | 489](#)
- [Release Information | 489](#)

Syntax

```
clear security forward-options mirror-filter (all | filter-name)
```

Description

Clear statistics about configured mirror filters.

Options

- | | |
|---------------------------|---|
| all | Clear statistics for all configured mirror filters. |
| <i>filter-name</i> | Clear statistics for the specified mirror filter. |

Required Privilege Level

clear

Release Information

Command introduced in Junos OS Release 12.1X46-D10.

RELATED DOCUMENTATION

[mirror-filter \(Security Forwarding Options\) | 345](#)

[show security forwarding-options mirror-filter | 819](#)

monitor security flow file

IN THIS SECTION

- [Syntax | 489](#)
- [Description | 490](#)
- [Options | 490](#)
- [Required Privilege Level | 491](#)
- [Output Fields | 491](#)
- [Release Information | 491](#)

Syntax

```
monitor security flow file  
  <file-name>  
  <files number>
```

```
<match regular-expression>
<size maximum-file-size>
<(world-readable | no-world-readable)>
```

Description

Configure options for the security flow monitoring output.

Options

<i>filename</i>	Name of the file to receive the output of the monitoring operation. All output is saved in the <code>/var/log/</code> directory.
<i>files number</i>	Maximum number of output files. If you specify a maximum number of files, you must also specify a maximum file size with the <code>size</code> option. Range: 2 through 1000 files Default: 10 files
<i>match regular-expression</i>	Refine the output to include lines that contain the regular expression.
<i>size maximum-file-size</i>	Maximum size of each output file. When an output file named <code>output</code> reaches this size, it is renamed <code>output.0</code> . When the output file again reaches its maximum size, <code>output.0</code> is renamed <code>output.1</code> and output file is renamed <code>output.0</code> . This renaming scheme continues until the maximum number of output files is reached. Then the oldest output file is overwritten. If you specify a maximum file size, you also must specify a maximum number of output files with the <code>files</code> option. Range: 10 KB through 1 GB Default: 128 KB
<i>(world-readable no-world-readable)</i>	By default, the output files can be accessed only by the user who configures the monitoring operation. The <code>world-readable</code> option enables all users to read the file. To explicitly set the default behavior, use the <code>no-world-readable</code> option.

Required Privilege Level

trace

Output Fields

This command produces no output.

Release Information

Command introduced in Junos OS Release 12.1X46-D10.

RELATED DOCUMENTATION

[Monitoring Security Flow Sessions Overview | 186](#)

[monitor security flow filter | 491](#)

[monitor security flow start | 494](#)

[show monitor security flow | 567](#)

monitor security flow filter

IN THIS SECTION

- [Syntax | 492](#)
- [Description | 492](#)
- [Options | 492](#)
- [Required Privilege Level | 493](#)
- [Release Information | 493](#)

Syntax

```
monitor security flow filter filter-name
<conn-tag session-connection-tag>
<destination-port (port-range | protocol-name)>
<destination-prefix destination-prefix>
<interface interface-name>
<logical-system logical-system-name>
<protocol (protocol name | protocol number)>
<root-logical-system>
<source-port (port-range | protocol-name)>
<source-prefix source-prefix>
```

Description

Set security flow filters to define flow sessions that you want to monitor. A maximum of 64 filters is supported at a time.

Defining the filters themselves does not trigger monitoring. You must explicitly use the `monitor security flow start` command to enable monitoring. Once monitoring starts, any traffic that matches the specified filters is saved in an output file in the `/var/log/` directory.

NOTE: Unlike filters defined in the configuration mode, these filters defined using operational mode commands are cleared when you reboot your system. They are used expressly for debugging purposes.

Options

filter <i>filter-name</i>	Specify a name for the filter. The filter name can contain letters, numbers, underscores (_) and hyphens (-) and can be up to 64 characters long.
conn-tag	Specify the session connection tag. The session connection tag uniquely identifies a session.

destination-port (<i>port-range</i> <i>protocol-name</i>)	Specify the TCP or UDP destination port to match. You can also specify a range of TCP or UDP destination ports and monitor all traffic in this group.
destination-prefix <i>destination-prefix</i>	Specify the destination IPv4 or IPv6 address prefix to match.
interface <i>interface-name</i>	Specify the logical interface name to match.
logical-system <i>logical-system-name</i>	Specify the logical system name to match.
protocol (<i>protocol name</i> <i>protocol number</i>)	Specify the IP protocol type to match.
root-logical-system	(Default) Specify the root logical system to match.
source-port (<i>port-range</i> <i>protocol-name</i>)	Specify the TCP or UDP source port to match. You can also specify a range of TCP or UDP source ports and monitor all traffic in this group.
source-prefix <i>source-prefix</i>	Specify the source IP address prefix to match.

Required Privilege Level

view

Release Information

Command introduced in Junos OS Release 12.1X46-D10. The was updated in Junos OS Release 15.1X49-D70 with the addition of the conn-tag filter parameter.

RELATED DOCUMENTATION

[Monitoring Security Flow Sessions Overview | 186](#)

[monitor security flow file | 489](#)

[monitor security flow start | 494](#)

[monitor security flow stop | 495](#)

monitor security flow start

IN THIS SECTION

- [Syntax | 494](#)
- [Description | 494](#)
- [Options | 494](#)
- [Required Privilege Level | 495](#)
- [Output Fields | 495](#)
- [Release Information | 495](#)

Syntax

```
monitor security flow start
```

Description

Start the monitoring of security flow session. Once monitoring starts, any traffic that matches the specified filters is saved in an output file in the `var/log/` directory. At least one filter must be defined for the monitoring to start.

Use the `monitor security flow stop` command to stop the monitoring of flow sessions.

Options

This command has no options.

Required Privilege Level

trace

Output Fields

This command produces no output.

Release Information

Command introduced in Junos OS Release 12.1X46-D10.

RELATED DOCUMENTATION

[Monitoring Security Flow Sessions Overview | 186](#)

[show monitor security flow | 567](#)

[monitor security flow filter | 491](#)

[monitor security flow stop | 495](#)

monitor security flow stop

IN THIS SECTION

- [Syntax | 496](#)
- [Description | 496](#)
- [Options | 496](#)
- [Required Privilege Level | 496](#)
- [Output Fields | 496](#)
- [Release Information | 496](#)

Syntax

```
monitor security flow stop
```

Description

Stop monitoring the security flow session. Use the `monitor security flow start` command to start the monitoring of flow sessions.

Options

This command has no options.

Required Privilege Level

trace

Output Fields

This command produces no output.

Release Information

Command introduced in Junos OS Release 12.1X46-D10.

RELATED DOCUMENTATION

[Monitoring Security Flow Sessions Overview | 186](#)

[monitor security flow start | 494](#)

monitor security packet-drop

IN THIS SECTION

- [Syntax | 497](#)
- [Description | 497](#)
- [Options | 498](#)
- [Required Privilege Level | 498](#)
- [Sample Output | 498](#)
- [Release Information | 501](#)

Syntax

```
monitor security packet-drop  
<source-prefix>  
<destination-prefix>  
<source-port>  
<destination-port>  
<ingress-interface-name>  
<protocol>  
<logical-system-name>  
<count-number>
```

Description

Displays the packet-drop information without committing the configuration, which allows you to trace and monitor the traffic flow. This command output is displayed on the screen until you press **Ctrl+c** or until the security device collects the requested number of packet drops. The command includes various filters to generate the output fields per your requirement.

You can save the packet drop records to a file using the `monitor security packet-drop | append /var/log/ filename.log` command.

Options

source-prefix Display the packet drop information for the given source IP or source prefix address.

destination-prefix Display the packet drop information for the given destination IP or source prefix address.

source-port Display the packet drop information for the given source port.

destination-port Display the packet drop information for the given destination port.

ingress-interface-name Display the packet drop information for the given ingress interface address.

protocol Display the packet drop information for the given protocol number.

logical-system-name Display the packet drop information for the logical system name.

count-number Display the packet drop information for the given count.

Range: 1 thru 8000

Default: 50

Required Privilege Level

view

Sample Output

monitor security packet-drop

When configuration is set to default IDP security policy, using the command `set security idp idp-policy IDP_Default rulebase-ips rule 1 then action drop-packet`, the following type of output is displayed for **monitor security packet-drop** command.

```
user@host> monitor security packet-drop
```

Starting packet drop:

```
14:46:45.511471:LSYS-ID-00 4.0.0.1/19895-->5.0.0.1/1;icmp,ipid-0,ge-0/0/0.0,Dropped by IDP:IDP
drop SLL packet
```

When configuration is set to drop connection action, the following type of output is displayed for **monitor security packet-drop** command.

```
user@host> monitor security packet-drop
```

Starting packet drop:

```
14:46:45.511471:LSYS-ID-00 4.0.0.1/19895-->5.0.0.1/1;icmp,ipid-0,ge-0/0/0.0,Dropped by
IDP:Malformed IPV6 header in IPv4 tunnel
14:46:45.511471:LSYS-ID-00 4.0.0.1/19895-->5.0.0.1/1;icmp,ipid-0,ge-0/0/0.0,Dropped by IDP:Bad
TCP headers
```

Output for packet drops independent of IPS policies.

```
user@host> monitor security packet-drop
```

Starting packet drop:

```
14:46:45.511471:LSYS-ID-00 4.0.0.1/19895-->5.0.0.1/1;icmp,ipid-0,ge-0/0/0.0,Dropped by IDP:IDP
drop SLL packet
14:46:45.511471:LSYS-ID-00 4.0.0.1/19895-->5.0.0.1/1;icmp,ipid-0,ge-0/0/0.0,Dropped by
IDP:Malformed IPV6 header in IPv4 tunnel
14:46:45.511471:LSYS-ID-00 4.0.0.1/19895-->5.0.0.1/1;icmp,ipid-0,ge-0/0/0.0,Dropped by IDP:Bad
TCP headers
14:46:45.511471:LSYS-ID-00 4.0.0.1/19895-->5.0.0.1/1;icmp,ipid-0,ge-0/0/0.0,Dropped by
IDP:Overflow drops
14:46:45.511471:LSYS-ID-00 4.0.0.1/19895-->5.0.0.1/1;icmp,ipid-0,ge-0/0/0.0,Dropped by
IDP:Sequence number wrap around errors
14:46:45.511471:LSYS-ID-00 4.0.0.1/19895-->5.0.0.1/1;icmp,ipid-0,ge-0/0/0.0,Dropped by IDP:IDP
```

Policy Initn failed

```
14:46:45.511471:LSYS-ID-00 4.0.0.1/19895-->5.0.0.1/1;icmp,ipid-0,ge-0/0/0.0,Dropped by IDP:Flow Rejected
```

Output for packet drops dependent on IPS policies.

```
user@host> monitor security packet-drop
```

Starting packet drop:

```
14:46:45.511471:LSYS-ID-00 4.0.0.1/19895-->5.0.0.1/1;icmp,ipid-0,ge-0/0/0.0,Dropped by IDP:IDP Rule Action Drop Packet ICMP:INFO:ECHO-REQUEST
```

```
14:46:45.511471:LSYS-ID-00 4.0.0.1/19895-->5.0.0.1/1;icmp,ipid-0,ge-0/0/0.0,Dropped by IDP:IDP Rule Action Close-Client-And-Server ICMP:INFO:ECHO-REQUEST
```

```
14:46:45.511471:LSYS-ID-00 4.0.0.1/19895-->5.0.0.1/1;icmp,ipid-0,ge-0/0/0.0,Dropped by IDP:IDP Rule Action Close-Server ICMP:INFO:ECHO-REQUEST
```

```
14:46:45.511471:LSYS-ID-00 4.0.0.1/19895-->5.0.0.1/1;icmp,ipid-0,ge-0/0/0.0,Dropped by IDP:IDP Rule Action Close-Client ICMP:INFO:ECHO-REQUEST
```

monitor security packet-drop with filters

```
user@host> monitor security packet-drop source-prefix 192.0.2.1 destination-prefix 192.151.100.1 proto icmp
```

```
14:46:45.511471:LSYS-ID-00 192.0.2.1/19895-->192.151.100.1/1;icmp,ipid-0,ge-0/0/0.0,Dropped by IDP:IDP Rule Action Close-Server ICMP:INFO:ECHO-REQUEST
```

```
14:46:45.511471:LSYS-ID-00 192.0.2.1/19895-->192.151.100.1/1;icmp,ipid-0,ge-0/0/0.0,Dropped by IDP:IDP Rule Action Close-Client ICMP:INFO:ECHO-REQUEST
```

monitor security packet-drop count 2

```
user@host> monitor security packet-drop count 2
```

```
14:46:45.511471:LSYS-ID-00 192.0.2.1/19895-->192.151.100.1/1;icmp,ipid-0,ge-0/0/0.0,Dropped by IDP:IDP Rule Action Close-Server ICMP:INFO:ECHO-REQUEST
```

```
14:46:45.511471:LSYS-ID-00 192.0.2.1/19895-->192.151.100.1/1;icmp,ipid-0,ge-0/0/0.0,Dropped by
IDP:IDP Rule Action Close-Server ICMP:INFO:ECHO-REQUEST
```

monitor security packet-drop | append /var/log/abcd.log

```
user@host> monitor security packet-drop | append /var/log/abcd.log
```

```
^C[abort]
Wrote 7 lines of output to '/var/log/abcd.log'
```

show log abcd.log

```
user@host> show log abcd.log
```

```
Starting packet drop:
07:35:36.742809:LSYS-ID-00 192.0.2.1/2198-->192.151.100.1/1;icmp,ipid-16088,ge-0/0/2.0,Dropped
by POLICY:Denied by Policy: default-policy-logical-system-00
07:35:37.640858:LSYS-ID-00 192.0.2.1/2198-->192.151.100.1/2;icmp,ipid-52440,ge-0/0/2.0,Dropped
by POLICY:Denied by Policy: default-policy-logical-system-00
07:35:38.665155:LSYS-ID-00 192.0.2.1/2198-->192.151.100.1/3;icmp,ipid-28633,ge-0/0/2.0,Dropped
by POLICY:Denied by Policy: default-policy-logical-system-00
07:35:39.689185:LSYS-ID-00 192.0.2.1/2198-->192.151.100.1/4;icmp,ipid-47577,ge-0/0/2.0,Dropped
by POLICY:Denied by Policy: default-policy-logical-system-00
07:35:40.712870:LSYS-ID-00 192.0.2.1/2198-->192.151.100.1/5;icmp,ipid-44762,ge-0/0/2.0,Dropped
by POLICY:Denied by Policy: default-policy-logical-system-00
07:35:41.797742:LSYS-ID-00 192.0.2.1/2198-->192.151.100.1/6;icmp,ipid-16859,ge-0/0/2.0,Dropped
by POLICY:Denied by Policy: default-policy-logical-system-00
```

Release Information

Command introduced in Junos OS Release 21.1R1.

Signature added to packet drop reason in Junos OS Release 21.2R2.

show chassis environment (Security)

IN THIS SECTION

- [Syntax | 502](#)
- [Description | 502](#)
- [Options | 502](#)
- [Required Privilege Level | 503](#)
- [Output Fields | 503](#)
- [Sample Output | 503](#)
- [Release Information | 509](#)

Syntax

```
show chassis environment
```

Description

Display environmental information about the services gateway chassis, including the temperature and information about the fans, power supplies, and Routing Engine.

Options

none	Display environmental information about the device.
cb <i>slot-number</i>	Display chassis environmental information for the Control Board.
fpc <i>fpc-slot</i>	Display chassis environmental information for a specified Flexible PIC Concentrator.

fpm	Display chassis environmental information for the craft interface (FPM).
node	Display node specific chassis information.
pem <i>slot-number</i>	Display chassis environmental information for the specified Power Entry Module.
routing-engine <i>slot-number</i>	Display chassis environmental information for the specified Routing Engine.

Required Privilege Level

view

Output Fields

[Table 24 on page 503](#) lists the output fields for the `show chassis environment` command. Output fields are listed in the approximate order in which they appear.

Table 24: show chassis environment Output Fields

Field Name	Field Description
Temp	Temperature of air flowing through the chassis in degrees Celsius (C) and Fahrenheit (F).
Fan	Fan status: OK, Testing (during initial power-on), Failed, or Absent.

Sample Output

`show chassis environment`

```

user@host> show chassis environment
user@host> show chassis environment
Class Item                               Status    Measurement

```

Temp	PEM 0	OK	40 degrees C / 104 degrees F
	PEM 1	OK	40 degrees C / 104 degrees F
	PEM 2	OK	40 degrees C / 104 degrees F
	PEM 3	OK	45 degrees C / 113 degrees F
	Routing Engine 0	OK	31 degrees C / 87 degrees F
	Routing Engine 0 CPU	OK	27 degrees C / 80 degrees F
	Routing Engine 1	Absent	
	Routing Engine 1 CPU	Absent	
	CB 0 Intake	OK	28 degrees C / 82 degrees F
	CB 0 Exhaust A	OK	27 degrees C / 80 degrees F
	CB 0 Exhaust B	OK	29 degrees C / 84 degrees F
	CB 0 ACBC	OK	29 degrees C / 84 degrees F
	CB 0 SF A	OK	36 degrees C / 96 degrees F
	CB 0 SF B	OK	31 degrees C / 87 degrees F
	CB 1 Intake	OK	27 degrees C / 80 degrees F
	CB 1 Exhaust A	OK	26 degrees C / 78 degrees F
	CB 1 Exhaust B	OK	29 degrees C / 84 degrees F
	CB 1 ACBC	OK	27 degrees C / 80 degrees F
	CB 1 SF A	OK	36 degrees C / 96 degrees F
	CB 1 SF B	OK	31 degrees C / 87 degrees F
	CB 2 Intake	Absent	
	CB 2 Exhaust A	Absent	
	CB 2 Exhaust B	Absent	
	CB 2 ACBC	Absent	
	CB 2 XF A	Absent	
	CB 2 XF B	Absent	
	FPC 0 Intake	OK	47 degrees C / 116 degrees F
	FPC 0 Exhaust A	OK	44 degrees C / 111 degrees F
	FPC 0 Exhaust B	OK	52 degrees C / 125 degrees F
	FPC 0 xlp0 TSen	OK	51 degrees C / 123 degrees F
	FPC 0 xlp0 Chip	OK	46 degrees C / 114 degrees F
	FPC 0 xlp1 TSen	OK	51 degrees C / 123 degrees F
	FPC 0 xlp1 Chip	OK	47 degrees C / 116 degrees F
	FPC 0 xlp2 TSen	OK	44 degrees C / 111 degrees F
	FPC 0 xlp2 Chip	OK	42 degrees C / 107 degrees F
	FPC 0 xlp3 TSen	OK	48 degrees C / 118 degrees F
	FPC 0 xlp3 Chip	OK	43 degrees C / 109 degrees F
	FPC 1 Intake	OK	41 degrees C / 105 degrees F
	FPC 1 Exhaust A	OK	41 degrees C / 105 degrees F
	FPC 1 Exhaust B	OK	51 degrees C / 123 degrees F
	FPC 1 LU TSen	OK	46 degrees C / 114 degrees F
	FPC 1 LU Chip	OK	45 degrees C / 113 degrees F
	FPC 1 XM TSen	OK	46 degrees C / 114 degrees F

FPC 1 XM Chip	OK	52 degrees C / 125 degrees F
FPC 1 xlp0 TSen	OK	49 degrees C / 120 degrees F
FPC 1 xlp0 Chip	OK	42 degrees C / 107 degrees F
FPC 1 xlp1 TSen	OK	49 degrees C / 120 degrees F
FPC 1 xlp1 Chip	OK	44 degrees C / 111 degrees F
FPC 1 xlp2 TSen	OK	38 degrees C / 100 degrees F
FPC 1 xlp2 Chip	OK	39 degrees C / 102 degrees F
FPC 1 xlp3 TSen	OK	44 degrees C / 111 degrees F
FPC 1 xlp3 Chip	OK	42 degrees C / 107 degrees F
FPC 2 Intake	OK	29 degrees C / 84 degrees F
FPC 2 Exhaust A	OK	34 degrees C / 93 degrees F
FPC 2 Exhaust B	OK	40 degrees C / 104 degrees F
FPC 2 I3 0 TSensor	OK	42 degrees C / 107 degrees F
FPC 2 I3 0 Chip	OK	41 degrees C / 105 degrees F
FPC 2 I3 1 TSensor	OK	40 degrees C / 104 degrees F
FPC 2 I3 1 Chip	OK	39 degrees C / 102 degrees F
FPC 2 I3 2 TSensor	OK	38 degrees C / 100 degrees F
FPC 2 I3 2 Chip	OK	37 degrees C / 98 degrees F
FPC 2 I3 3 TSensor	OK	35 degrees C / 95 degrees F
FPC 2 I3 3 Chip	OK	35 degrees C / 95 degrees F
FPC 2 IA 0 TSensor	OK	45 degrees C / 113 degrees F
FPC 2 IA 0 Chip	OK	42 degrees C / 107 degrees F
FPC 2 IA 1 TSensor	OK	41 degrees C / 105 degrees F
FPC 2 IA 1 Chip	OK	43 degrees C / 109 degrees F
FPC 9 Intake	OK	29 degrees C / 84 degrees F
FPC 9 Exhaust A	OK	41 degrees C / 105 degrees F
FPC 9 Exhaust B	OK	48 degrees C / 118 degrees F
FPC 9 LU TSen	OK	48 degrees C / 118 degrees F
FPC 9 LU Chip	OK	47 degrees C / 116 degrees F
FPC 9 XM TSen	OK	48 degrees C / 118 degrees F
FPC 9 XM Chip	OK	54 degrees C / 129 degrees F
FPC 9 xlp0 TSen	OK	45 degrees C / 113 degrees F
FPC 9 xlp0 Chip	OK	42 degrees C / 107 degrees F
FPC 9 xlp1 TSen	OK	49 degrees C / 120 degrees F
FPC 9 xlp1 Chip	OK	46 degrees C / 114 degrees F
FPC 9 xlp2 TSen	OK	37 degrees C / 98 degrees F
FPC 9 xlp2 Chip	OK	40 degrees C / 104 degrees F
FPC 9 xlp3 TSen	OK	45 degrees C / 113 degrees F
FPC 9 xlp3 Chip	OK	41 degrees C / 105 degrees F
FPC 10 Intake	OK	32 degrees C / 89 degrees F
FPC 10 Exhaust A	OK	44 degrees C / 111 degrees F
FPC 10 Exhaust B	OK	53 degrees C / 127 degrees F
FPC 10 LU 0 TSen	OK	43 degrees C / 109 degrees F

FPC 10 LU 0 Chip	OK	52 degrees C / 125 degrees F
FPC 10 LU 1 TSen	OK	43 degrees C / 109 degrees F
FPC 10 LU 1 Chip	OK	44 degrees C / 111 degrees F
FPC 10 LU 2 TSen	OK	43 degrees C / 109 degrees F
FPC 10 LU 2 Chip	OK	50 degrees C / 122 degrees F
FPC 10 LU 3 TSen	OK	43 degrees C / 109 degrees F
FPC 10 LU 3 Chip	OK	58 degrees C / 136 degrees F
FPC 10 XM 0 TSen	OK	43 degrees C / 109 degrees F
FPC 10 XM 0 Chip	OK	53 degrees C / 127 degrees F
FPC 10 XF 0 TSen	OK	43 degrees C / 109 degrees F
FPC 10 XF 0 Chip	OK	64 degrees C / 147 degrees F
FPC 10 PLX Switch TSen	OK	43 degrees C / 109 degrees F
FPC 10 PLX Switch Chip	OK	44 degrees C / 111 degrees F
FPC 11 Intake	OK	32 degrees C / 89 degrees F
FPC 11 Exhaust A	OK	41 degrees C / 105 degrees F
FPC 11 Exhaust B	OK	56 degrees C / 132 degrees F
FPC 11 LU 0 TSen	OK	45 degrees C / 113 degrees F
FPC 11 LU 0 Chip	OK	50 degrees C / 122 degrees F
FPC 11 LU 1 TSen	OK	45 degrees C / 113 degrees F
FPC 11 LU 1 Chip	OK	47 degrees C / 116 degrees F
FPC 11 LU 2 TSen	OK	45 degrees C / 113 degrees F
FPC 11 LU 2 Chip	OK	52 degrees C / 125 degrees F
FPC 11 LU 3 TSen	OK	45 degrees C / 113 degrees F
FPC 11 LU 3 Chip	OK	60 degrees C / 140 degrees F
FPC 11 XM 0 TSen	OK	45 degrees C / 113 degrees F
FPC 11 XM 0 Chip	OK	56 degrees C / 132 degrees F
FPC 11 XF 0 TSen	OK	45 degrees C / 113 degrees F
FPC 11 XF 0 Chip	OK	65 degrees C / 149 degrees F
FPC 11 PLX Switch TSen	OK	45 degrees C / 113 degrees F
FPC 11 PLX Switch Chip	OK	46 degrees C / 114 degrees F
Fans Top Fan Tray Temp	OK	34 degrees C / 93 degrees F
Top Tray Fan 1	OK	Spinning at normal speed
Top Tray Fan 2	OK	Spinning at normal speed
Top Tray Fan 3	OK	Spinning at normal speed
Top Tray Fan 4	OK	Spinning at normal speed
Top Tray Fan 5	OK	Spinning at normal speed
Top Tray Fan 6	OK	Spinning at normal speed
Top Tray Fan 7	OK	Spinning at normal speed
Top Tray Fan 8	OK	Spinning at normal speed
Top Tray Fan 9	OK	Spinning at normal speed
Top Tray Fan 10	OK	Spinning at normal speed
Top Tray Fan 11	OK	Spinning at normal speed
Top Tray Fan 12	OK	Spinning at normal speed

Bottom Fan Tray Temp	OK	31 degrees C / 87 degrees F	
Bottom Tray Fan 1	OK	Spinning at normal speed	
Bottom Tray Fan 2	OK	Spinning at normal speed	
Bottom Tray Fan 3	OK	Spinning at normal speed	
Bottom Tray Fan 4	OK	Spinning at normal speed	
Bottom Tray Fan 5	OK	Spinning at normal speed	
Bottom Tray Fan 6	OK	Spinning at normal speed	
Bottom Tray Fan 7	OK	Spinning at normal speed	
Bottom Tray Fan 8	OK	Spinning at normal speed	
Bottom Tray Fan 9	OK	Spinning at normal speed	
Bottom Tray Fan 10	OK	Spinning at normal speed	
Bottom Tray Fan 11	OK	Spinning at normal speed	
Bottom Tray Fan 12	OK	Spinning at normal speed	OK

When you enter the **show chassis environment pem** command, the sample output is shown for AC PEM.

```
user@host# run show chassis environment pem node 0 | no-more
node0:
-----
PEM 0 status:
  State           Online
  Airflow         Front to Back
  Temperature     OK
  DC Output       Voltage(V) Current(A) Power(W) Load(%)
                  12          9         108    16
PEM 1 status:
  State           Online
  Airflow         Front to Back
  Temperature     OK
  DC Output       Voltage(V) Current(A) Power(W) Load(%)
                  12          9         108    16
```

When you enter the **show chassis environment pem** command, the sample output is shown for DC PEM.

```
user@host> show chassis environment pem
node0:
-----
PEM 0 status:
  State           Online
```

```

Temperature          OK
DC Input:            OK
DC Output            Voltage(V) Current(A) Power(W) Load(%)
                    50          12          600    24

PEM 1 status:
State                Online
Temperature          OK
DC Input:            OK
DC Output            Voltage(V) Current(A) Power(W) Load(%)
                    50          31          1550   63

node1:
-----
PEM 0 status:
State                Online
Temperature          OK
DC Input:            OK
DC Output            Voltage(V) Current(A) Power(W) Load(%)
                    50          12          600    24

PEM 1 status:
State                Online
Temperature          OK
DC Input:            OK
DC Output            Voltage(V) Current(A) Power(W) Load(%)
                    49          31          1519   62

```

show chassis environment fpc (SRX5800, SRX5400, and SRX5600)

```

user@host> show chassis environment fpc
FPC 1 status:
State                Online
Temperature Intake    34 degrees C / 93 degrees F
Temperature Exhaust A 48 degrees C / 118 degrees F
Temperature Exhaust B 48 degrees C / 118 degrees F
Temperature CPU0 DTS   55 degrees C / 131 degrees F
Temperature CPU1 DTS   60 degrees C / 140 degrees F
Temperature CPU2 DTS   54 degrees C / 129 degrees F
Temperature CPU3 DTS   70 degrees C / 158 degrees F
Temperature Talus 0    106 degrees C / 222 degrees F
Temperature Middle 0   40 degrees C / 104 degrees F

```

```

Temperature Talus 1      76 degrees C / 168 degrees F
Temperature Middle 1    67 degrees C / 152 degrees F
Power
  TALUS0-1.20V          1199 mV  14187 mA  17010 mW
  TALUS0-0.90V          900 mV   5000 mA   4500 mW
  BIAS0-3.30V           3299 mV  3769 mA  12433 mW
  PIC0_CPU_memory_CD-1.20 1199 mV  3781 mA   4533 mW
  USB0-5.00V            5000 mV   155 mA    775 mW
  PIC0_CPU_memory_AB-1.20 1200 mV  5820 mA   6984 mW
  PCH0-1.05V            1050 mV  3582 mA   3761 mW
  TALUS1-1.20V          1199 mV  13640 mA  16354 mW
  TALUS1-0.90V          899 mV   4679 mA   4206 mW
  BIAS1-3.30V           3300 mV  3175 mA  10477 mW
  PIC1_CPU_memory_GH-1.20 1200 mV  4648 mA   5577 mW
  USB1-5.00V            4999 mV   346 mA   1729 mW
  PIC1_CPU_memory_EF-1.20 1200 mV  5218 mA   6261 mW
  PCH1-1.05V            1050 mV  3328 mA   3494 mW
  TPS53641-CPU0          1750 mV  46062 mA  80608 mW
  TPS53641-CPU1          1739 mV  47437 mA  82492 mW
  TPS53641-CPU2          1750 mV  45250 mA  79187 mW
  TPS53641-CPU3          1739 mV  46875 mA  81515 mW
  ETH-1.00V              994 mV   2674 mA   2657 mW
  TALUS0_Core-0.85V     849 mV   37750 mA  32049 mW
  TALUS1_Core-0.85V     849 mV   26750 mA  22710 mW
  Power_Brick1-12.00V   12001 mV 21000 mA 252021 mW
  Power_Brick2-12.00V   11998 mV 23125 mA 277453 mW
  PIM4820_48V0-48.00V  58392 mV 10286 mA 600620 mW
  I2C Slave Revision    0

```

Release Information

Command introduced in Junos OS Release 9.2.

RELATED DOCUMENTATION

show chassis hardware (View)

show chassis hardware (View)

IN THIS SECTION

- [Syntax | 510](#)
- [Description | 510](#)
- [Options | 511](#)
- [Required Privilege Level | 512](#)
- [Output Fields | 512](#)
- [show chassis hardware | 517](#)
- [show chassis hardware \(SRX4200\) | 527](#)
- [show chassis hardware \(vSRX Virtual Firewall 3.0\) | 528](#)
- [show chassis hardware clei-models | 528](#)
- [Release Information | 529](#)

Syntax

```
show chassis hardware
<clei-models>
<detail | extensive>
<models>
<node(node-id | all | local | primary)>
```

Description

Display chassis hardware information.

Starting in Junos OS Release 20.1R1, when vSRX Virtual Firewall 3.0 performs resource management, the vCPUs and RAM available to the instance are assigned based on what has been allocated prior to launching the instance. A maximum of 32 cores will be assigned to SRXPFE, for flow processing. Any allocation of cores in excess of 32 will automatically be assigned to the Routing Engine. For example, if

36 cores are allocated to the VM during the creation process, 32 cores are assigned for flow processing and 4 cores will be assigned to the RE. For memory allocations, up to 64G of vRAM would be used by the SRXPFE. Any allocated memory in excess of 64G would be assigned to system memory and would not be used for maintaining flow sessions information.

Table 25: Recommended vCPU and vRAM Combinations

vCPU Number	vRAM Size (G)
2	4
5	8
9	16
17	32

On a deployed vSRX Virtual Firewall, only memory scale up is supported. Scaling down memory on a deployed vSRX Virtual Firewall, is not supported. If you need to scale down memory, then a fresh install is required.

Options

- `clei-models`—(Optional) Display Common Language Equipment Identifier Code (CLEI) barcode and model number for orderable field-replaceable units (FRUs).
- `detail | extensive`—(Optional) Display the specified level of output.
- `models`—(Optional) Display model numbers and part numbers for orderable FRUs.
- `node`—(Optional) For chassis cluster configurations, display chassis hardware information on a specific node (device) in the cluster.
 - `node-id`—Identification number of the node. It can be 0 or 1.
 - `local`—Display information about the local node.
 - `primary`—Display information about the primary node.

Required Privilege Level

view

Output Fields

Table 26 on page 512 lists the output fields for the `show chassis hardware` command. Output fields are listed in the approximate order in which they appear.

Table 26: show chassis hardware Output Fields

Field Name	Field Description
Item	Chassis component—Information about the backplane; power supplies; fan trays; Routing Engine; each Physical Interface Module (PIM)—reported as FPC and PIC—and each fan, blower, and impeller.
Version	Revision level of the chassis component.
Part Number	Part number for the chassis component.
Serial Number	Serial number of the chassis component. The serial number of the backplane is also the serial number of the device chassis. Use this serial number when you need to contact Juniper Networks Customer Support about the device chassis.
Assb ID or Assembly ID	Identification number that describes the FRU hardware.
FRU model number	Model number of FRU hardware component.
CLEI code	Common Language Equipment Identifier code. This value is displayed only for hardware components that use ID EEPROM format v2. This value is not displayed for components that use ID EEPROM format v1.
EEPROM Version	ID EEPROM version used by hardware component: 0x01 (version 1) or 0x02 (version 2).

Table 26: show chassis hardware Output Fields (Continued)

Field Name	Field Description
Description	<p data-bbox="597 365 1003 392">Brief description of the hardware item:</p> <ul data-bbox="597 426 922 520" style="list-style-type: none"> <li data-bbox="597 426 862 453">• Type of power supply. <li data-bbox="597 491 922 518">• Switch Control Board (SCB) <p data-bbox="634 552 1349 615">Starting with Junos OS Release 12.1X47-D15 and Junos OS Release 17.3R1, the SRX5K-SCBE (SCB2) is introduced.</p> <ul data-bbox="634 651 1409 1402" style="list-style-type: none"> <li data-bbox="634 651 1409 783">• There are three SCB slots in SRX5800 devices. The third slot can be used for an SCB or an FPC. When an SRX5K-SCB was used , the third SCB slot was used as an FPC. SCB redundancy is provided in chassis cluster mode. <li data-bbox="634 821 1409 884">• With an SCB2, a third SCB is supported. If a third SCB is plugged in, it provides intra-chassis fabric redundancy. <li data-bbox="634 921 1409 1094">• The Ethernet switch in the SCB2 provides the Ethernet connectivity among all the FPCs and the Routing Engine. The Routing Engine uses this connectivity to distribute forwarding and routing tables to the FPCs. The FPCs use this connectivity to send exception packets to the Routing Engine. <li data-bbox="634 1131 1409 1264">• Fabric connects all FPCs in the data plane. The Fabric Manager executes on the Routing Engine and controls the fabric system in the chassis. Packet Forwarding Engines on the FPC and fabric planes on the SCB are connected through HSL2 channels. <li data-bbox="634 1302 1409 1402">• SCB2 supports HSL2 with both 3.11 Gbps and 6.22 Gbps (SerDes) link speed and various HSL2 modes. When an FPC is brought online, the link speed and HSL2 mode are determined by the type of FPC. <p data-bbox="634 1438 1393 1501">Starting with Junos OS Release 15.1X49-D10 and Junos OS Release 17.3R1, the SRX5K-SCB3 (SCB3) with enhanced midplane is introduced.</p> <ul data-bbox="634 1537 1393 1669" style="list-style-type: none"> <li data-bbox="634 1537 1393 1600">• All existing SCB software that is supported by SCB2 is supported on SCB3. <li data-bbox="634 1638 1338 1665">• SRX5K-RE-1800X4 mixed Routing Engine use is not supported.

Table 26: show chassis hardware Output Fields (Continued)

Field Name	Field Description
	<ul style="list-style-type: none"> • SCB3 works with the SRX5K-MPC (IOC2), SRX5K-MPC3-100G10G (IOC3), SRX5K-MPC3-40G10G (IOC3), and SRX5K-SPC-4-15-320 (SPC2) with current midplanes and the new enhanced midplanes. • Mixed SCB use is not supported. If an SCB2 and an SCB3 are used, the system will only power on the primary Routing Engine's SCB and will power off the other SCBs. Only the SCB in slot 0 is powered on and a system log is generated. • SCB3 supports up to 400 Gbps per slot with old midplanes and up to 500 Gbps per slot with new midplanes. • SCB3 supports fabric intra-chassis redundancy. • SCB3 supports the same chassis cluster function as the SRX5K-SCB (SCB1) and the SRX5K-SCBE (SCB2), except for in-service software upgrade (ISSU) and in-service hardware upgrade (ISHU). • SCB3 has a second external Ethernet port. • Fabric bandwidth increasing mode is not supported. <p>Starting in Junos OS 19.3R1, SRX5K-SCB4 is supported on SRX5600 and SRX5800 devices along with SRX5K-SPC3.</p> <p>SRX5K-SCB4:</p> <ul style="list-style-type: none"> • Interoperate with SRX5K-RE3-128G, SRX5K-RE-1800X4, IOC2, IOC3, IOC4, SPC2, and SPC3. SCB4 is compatible with all midplanes and interoperate with existing PEMs, fan trays, and front panel displays. • Does not interoperate with SCB, SCB2, and SCB3. • Supports 480-Gbps link speed per slot. • Supports 1-Gigabit Ethernet interfaces speed with SRX5K-RE-1800X4 and 1-Gigabit, 2.5-Gigabit, and 10-Gigabit Ethernet speeds with SRX5K-RE3-128G. • Support ISHU and ISSU in chassis cluster.

Table 26: show chassis hardware Output Fields (Continued)

Field Name	Field Description
	<ul style="list-style-type: none"> • Supports fabric bandwidth mode and redundant fabric mode on SRX5600 and SRX5800 devices. The bandwidth mode is the new default mode which is necessary to configure redundant mode in setting up the chassis cluster successfully. • Type of Flexible PIC Concentrator (FPC), Physical Interface Card (PIC), Modular Interface Cards (MICs), and PIMs. • IOCs <p>Starting with Junos OS Release 15.1X49-D10 and Junos OS Release 17.3R1, the SRX5K-MPC3-100G10G (IOC3) and the SRX5K-MPC3-40G10G (IOC3) are introduced.</p> <ul style="list-style-type: none"> • IOC3 has two types of IOC3 MPCs, which have different built-in MICs: the 24x10GE + 6x40GE MPC and the 2x100GE + 4x10GE MPC. • IOC3 supports SCB3 and SRX5000 line backplane and enhanced backplane. • IOC3 can only work with SRX5000 line SCB2 and SCB3. If an SRX5000 line SCB is detected, IOC3 is offline, an FPC misconfiguration alarm is raised, and a system log message is generated. • IOC3 interoperates with SCB2 and SCB3. • IOC3 interoperates with the SRX5K-SPC-4-15-320 (SPC2) and the SRX5K-MPC (IOC2). • The maximum power consumption for one IOC3 is 645W. An enhanced power module must be used. • The IOC3 does not support the following command to set a PIC to go offline or online: <pre>request chassis pic fpc-slot <fpc-slot> pic-slot <pic-slot> <offline online> .</pre> • IOC3 supports 240 Gbps of throughput with the enhanced SRX5000 line backplane. • Chassis cluster functions the same as for the SRX5000 line IOC2.

Table 26: show chassis hardware Output Fields (Continued)

Field Name	Field Description
	<ul style="list-style-type: none"> • IOC3 supports intra-chassis and inter-chassis fabric redundancy mode. • IOC3 supports ISSU and ISHU in chassis cluster mode. • IOC3 supports intra-FPC and Inter-FPC Express Path (previously known as <i>services offloading</i>) with IPv4. • NAT of IPv4 and IPv6 in normal mode and IPv4 for Express Path mode. • All four PICs on the 24x10GE + 6x40GE cannot be powered on. A maximum of two PICs can be powered on at the same time. Use the <code>set chassis fpc <slot> pic <pic> power off</code> command to choose the PICs you want to power on. Fabric bandwidth increasing mode is not supported on IOC3. • SRX Clustering Module (SCM) • Fan tray <p>Starting in Junos OS Release 19.3R1, the SRX5K-IOC4-10G and SRX5K-IOC4-MRAT line cards are supported along with SRX5K-SPC3 on the SRX5000 line devices.</p> <p>SRX5K-IOC4-10G:</p> <ul style="list-style-type: none"> • Interoperates with SCB3, SCB4, SRX5K-RE-1800X4, SRX5K-RE3-128G, SPC2, SPC3, IOC2,IOC3, and IOC4. • Supports 480-Gbps speed. • Supports 40X10GE Interfaces with SCB3. • 40 10-Gigabit Ethernet port provides 10-Gigabit Ethernet MACsec support. • Supports reth and aggregated interfaces on the chassis cluster. • Supports ISSU and logical system on the chassis cluster. • Does not support SCB2.

Table 26: show chassis hardware Output Fields (Continued)

Field Name	Field Description
	<ul style="list-style-type: none"> • SRX5K-IOC4-MRAT with SCB3 supports 10-Gigabit, 40-Gigabit, and 100-Gigabit Ethernet Interfaces. • For hosts, the Routing Engine type. <p>Starting with Junos OS Release 12.1X47-D15 and Junos OS Release 17.3R1, the SRX5K-RE-1800X4 Routing Engine is introduced.</p> <ul style="list-style-type: none"> • The SRX5K-RE-1800X4 has an Intel Quad core Xeon processor, 16 GB of DRAM, and a 128-GB solid-state drive (SSD). <p>The number 1800 refers to the speed of the processor (1.8 GHz). The maximum required power for this Routing Engine is 90W.</p> <p>NOTE: The SRX5K-RE-1800X4 provides significantly better performance than the previously used Routing Engine, even with a single core.</p> <p>Starting in Junos OS Release 19.3R1, SRX5K-RE3-128G Routing Engine is supported along with SRX5K-SPC3 on the SRX5000 line devices.</p> <p>SRX5K-RE3-128G:</p> <ul style="list-style-type: none"> • Provides improved control plane performance and scalability. SRX5K-RE3-128G has Intel's Haswell-EP based processor with six cores. • Supports two 200G SSDs to store log files and 128-GB of memory for storing routing and forwarding tables and for other routing engines. • Interoperates with SCB3, SCB4, SRX5K-RE3-128G, SPC2, SPC3, IOC2, IOC3, and IOC4. • Does not support SCB2 and SRX5K-RE-1800X4.

show chassis hardware

show chassis hardware (SRX5800)

```
user@host> show chassis hardware
node0:
```

Hardware inventory:

Item	Version	Part number	Serial number	Description
Chassis			JN1267B0FAGA	SRX5800
Midplane	REV 42	760-063937	ACRL3065	Enhanced SRX5800
Backplane				
FPM Board	REV 05	760-061272	CAHE4860	Front Panel Display
PDM	Rev 01	740-063049	QCS2209509D	Power Distribution
Module				
PEM 0	Rev 04	740-034724	QCS171002016	PS 4.1kW; 200-240V AC
PEM 1	Rev 11	740-027760	QCS1825N07S	PS 4.1kW; 200-240V AC
Routing Engine 0	REV 01	750-095568	CALK8884	SRX5k RE-2000x6
Routing Engine 1	REV 01	750-095568	CADZ9076	SRX5k RE-2000x6
CB 0	REV 26	750-031391	CALV3002	SRX5k SCB4
CB 1	REV 26	750-031391	CALV3009	SRX5k SCB4
FPC 2	REV 28	750-073435	CALS4630	SPC3
CPU		BUILTIN	BUILTIN	SRX5k vCPP Broadwell
PIC 0		BUILTIN	BUILTIN	SPU Cp-Flow
PIC 1		BUILTIN	BUILTIN	SPU Flow
FPC 3	REV 17	750-044175	CABE7777	SRX5k SPC II
CPU		BUILTIN	BUILTIN	SRX5k DPC PPC
PIC 0		BUILTIN	BUILTIN	SPU Flow
PIC 1		BUILTIN	BUILTIN	SPU Flow
PIC 2		BUILTIN	BUILTIN	SPU Flow
PIC 3		BUILTIN	BUILTIN	SPU Flow
FPC 4	REV 08	750-061262	CAFD8147	SRX5k IOC II
CPU	REV 02	711-061263	CAFV7488	SRX5k MPC PMB
MIC 0	REV 03	750-055732	CAFV9369	20x 1GE(LAN) SFP
PIC 0		BUILTIN	BUILTIN	10x 1GE(LAN) SFP
Xcvr 0	REV 02	740-011613	PNB1GJR	SFP-SX
PIC 1		BUILTIN	BUILTIN	10x 1GE(LAN) SFP
FPC 5	REV 10	750-062242	CAKX2328	SRX5k IOC3 2CGE+4XGE
PIC 0		BUILTIN	BUILTIN	2x 10GE SFP+
Xcvr 0	REV 01	740-021308	ANA07RE	SFP+-10G-SR
Xcvr 1	REV 01	740-031980	AQF0RBJ	SFP+-10G-SR
PIC 1		BUILTIN	BUILTIN	1x 100GE CFP2
PIC 2		BUILTIN	BUILTIN	2x 10GE SFP+

Xcvr 0	REV 01	740-031980	AA1650304RF	SFP+-10G-SR
Xcvr 1	REV 01	740-021308	AQ93BDK	SFP+-10G-SR
PIC 3		BUILTIN	BUILTIN	1x 100GE CFP2
FPC 8	REV 46	750-056519	CALC4514	SRX5k IOC4 MRAT
CPU	REV 21	750-057177	CALC3494	SMPC PMB
PIC 0		BUILTIN	BUILTIN	MRATE-6xQSFP-XGE-XLGE-CGE
Xcvr 0	REV 01	740-059437	000T20128	QSFP28-LPBK
Xcvr 1	REV 01	740-067443	1ACP13450KH	QSFP+-40G-SR4
PIC 1		BUILTIN	BUILTIN	MRATE-6xQSFP-XGE-XLGE-CGE
Xcvr 0	REV 01	740-059437	0000T3443	QSFP28-LPBK
Fan Tray 0	REV 06	740-035409	ACAE9390	Enhanced Fan Tray
Fan Tray 1	REV 06	740-035409	ACAE9386	Enhanced Fan Tray

node1:

Hardware inventory:

Item	Version	Part number	Serial number	Description
Chassis			JN1267B01AGA	SRX5800
Midplane	REV 42	760-063937	ACRL3068	Enhanced SRX5800 Backplane
FPM Board	REV 05	760-061272	CAJX9988	Front Panel Display
PDM	Rev 01	740-063049	QCS2209507A	Power Distribution Module
PEM 0	Rev 11	740-027760	QCS1822N0EY	PS 4.1kW; 200-240V AC in
PEM 1	Rev 03	740-034724	QCS17020203F	PS 4.1kW; 200-240V AC in
Routing Engine 0	REV 01	750-095568	CALK8904	SRX5k RE-2000x6
Routing Engine 1	REV 01	750-095568	CADZ9076	SRX5k RE-2000x6
CB 0	REV 26	750-031391	CALV3010	SRX5k SCB4
CB 1	REV 26	750-031391	CALV3000	SRX5k SCB4
FPC 2	REV 28	750-073435	CAKZ9620	SPC3
CPU		BUILTIN	BUILTIN	SRX5k vCPP Broadwell
PIC 0		BUILTIN	BUILTIN	SPU Cp-Flow
PIC 1		BUILTIN	BUILTIN	SPU Flow
FPC 3	REV 18	750-054877	CACH4082	SRX5k SPC II
CPU		BUILTIN	BUILTIN	SRX5k DPC PPC
PIC 0		BUILTIN	BUILTIN	SPU Flow
PIC 1		BUILTIN	BUILTIN	SPU Flow
PIC 2		BUILTIN	BUILTIN	SPU Flow
PIC 3		BUILTIN	BUILTIN	SPU Flow
FPC 4	REV 08	750-061262	CAFD8165	SRX5k IOC II
CPU	REV 02	711-061263	CAFV7507	SRX5k MPC PMB
MIC 0	REV 03	750-055732	CAFV6603	20x 1GE(LAN) SFP
PIC 0		BUILTIN	BUILTIN	10x 1GE(LAN) SFP
Xcvr 0	REV 01	740-011613	AM0805S8M4N	SFP-SX
PIC 1		BUILTIN	BUILTIN	10x 1GE(LAN) SFP

```

FPC 5          REV 03  750-062242  CAFZ2748      SRX5k IOC3 2CGE+4XGE
  PIC 0                BUILTIN      BUILTIN        2x 10GE SFP+
    Xcvr 0          REV 01  740-021308  11T511100788 SFP+-10G-SR
    Xcvr 1          REV 01  740-031980  AS92WJ0       SFP+-10G-SR
  PIC 1                BUILTIN      BUILTIN        1x 100GE CFP2
  PIC 2                BUILTIN      BUILTIN        2x 10GE SFP+
    Xcvr 0          REV 01  740-031980  AA1650304EZ  SFP+-10G-SR
    Xcvr 1          REV 01  740-031980  ANS0EAR       SFP+-10G-SR
  PIC 3                BUILTIN      BUILTIN        1x 100GE CFP2
FPC 8          REV 46  750-056519  CALC4526      SRX5k IOC4 MRAT
  CPU          REV 21  750-057177  CALF5727      SMPC PMB
  PIC 0                BUILTIN      BUILTIN        MRATE-6xQSFPP-XGE-XLGE-CGE
    Xcvr 1          REV 01  740-067443  1ACP13450L9  QSFP+-40G-SR4
  PIC 1                BUILTIN      BUILTIN        MRATE-6xQSFPP-XGE-XLGE-CGE
Fan Tray 0     REV 06  740-035409  ACAE9298      Enhanced Fan Tray
Fan Tray 1     REV 06  740-035409  ACAE9314      Enhanced Fan Tray

```

```
{primary:node0}
```

show chassis hardware (SRX5600 and SRX5800 devices for SRX5K-MPC)

```

user@host> show chassis hardware
Hardware inventory:
Item          Version  Part number  Serial number  Description
Chassis                               JN12170EAAGA  SRX 5800
Midplane      REV 01  710-041799  ACAX3849      SRX 5800 Backplane
FPM Board     REV 01  710-024632  CAAX7297      Front Panel Display
PDM           Rev 03  740-013110  QCS170250DU  Power Distribution Module
PEM 0         Rev 03  740-034724  QCS17020203F PS 4.1kW; 200-240V AC input
PEM 1         Rev 03  740-034724  QCS17020203C PS 4.1kW; 200-240V AC input
PEM 2         Rev 04  740-034724  QCS17100200A PS 4.1kW; 200-240V AC input
PEM 3         Rev 03  740-034724  QCS17080200M PS 4.1kW; 200-240V AC input
Routing Engine 0 REV 11  740-023530  9012047437   SRX5k RE-13-20
CB 0          REV 09  710-024802  CAAX7202     SRX5k SCB
CB 1          REV 09  710-024802  CAAX7157     SRX5k SCB
FPC 0         REV 07  750-044175  CAAD0791     SRX5k SPC II

```

CPU		BUILTIN	BUILTIN	SRX5k DPC PPC		
PIC 0		BUILTIN	BUILTIN	SPU Cp		
PIC 1		BUILTIN	BUILTIN	SPU Flow		
PIC 2		BUILTIN	BUILTIN	SPU Flow		
PIC 3		BUILTIN	BUILTIN	SPU Flow		
FPC 1	REV 07	750-044175	CAAD0751	SRX5k SPC II		
CPU		BUILTIN	BUILTIN	SRX5k DPC PPC		
PIC 0		BUILTIN	BUILTIN	SPU Flow		
PIC 1		BUILTIN	BUILTIN	SPU Flow		
PIC 2		BUILTIN	BUILTIN	SPU Flow		
PIC 3		BUILTIN	BUILTIN	SPU Flow		
FPC 2	REV 28	750-020751	CAAW1817	SRX5k DPC 4X 10GE		
CPU	REV 04	710-024633	CAAZ5269	SRX5k DPC PMB		
PIC 0		BUILTIN	BUILTIN	1x 10GE(LAN/WAN) RichQ		
Xcvr 0	REV 02	740-014289	T10A00404	XFP-10G-SR		
PIC 1		BUILTIN	BUILTIN	1x 10GE(LAN/WAN) RichQ		
PIC 2		BUILTIN	BUILTIN	1x 10GE(LAN/WAN) RichQ		
PIC 3		BUILTIN	BUILTIN	1x 10GE(LAN/WAN) RichQ		
FPC 6	REV 02	750-044175	ZY2552	SRX5k SPC II		
CPU		BUILTIN	BUILTIN	SRX5k DPC PPC		
FPC 9	REV 10	750-044175	CAAP5932	SRX5k SPC II		
CPU		BUILTIN	BUILTIN	SRX5k DPC PPC		
PIC 0		BUILTIN	BUILTIN	SPU Flow		
PIC 1		BUILTIN	BUILTIN	SPU Flow		
PIC 2		BUILTIN	BUILTIN	SPU Flow		
PIC 3		BUILTIN	BUILTIN	SPU Flow		
FPC 10	REV 22	750-043157	ZH8192	SRX5k IOC II	CPU	REV 08
711-043360	YX3879		SRX5k MPC PMB			
MIC 0	REV 01	750-049488	YZ2084	10x 10GE SFP+		
PIC 0		BUILTIN	BUILTIN	10x 10GE SFP+		
Xcvr 0	REV 01	740-031980	AMB0HG3	SFP+-10G-SR		
Xcvr 1	REV 01	740-031980	AM20B6F	SFP+-10G-SR		
MIC 1	REV 19	750-049486	CAAH3504	1x 100GE CFP		
PIC 2		BUILTIN	BUILTIN	1x 100GE CFP		
Xcvr 0	REV 01	740-035329	X000D375	CFP-100G-SR10		
FPC 11	REV 07.04.07	750-043157	CAAJ8771	SRX5k IOC II	CPU	REV 08
711-043360	CAAJ3881		SRX5k MPC PMB			
MIC 0	REV 19	750-049486	CAAH0979	1x 100GE CFP		
PIC 0		BUILTIN	BUILTIN	1x 100GE CFP		
Xcvr 0	REV 01	740-035329	UP1020Z	CFP-100G-SR10		
MIC 1	REV 08	750-049487	CAAM1160	2x 40GE QSFP+		
PIC 2		BUILTIN	BUILTIN	2x 40GE QSFP+		
Xcvr 0	REV 01	740-032986	QB151094	QSFP+-40G-SR4		

Xcvr 1	REV 01	740-032986	QB160509	QSFP+-40G-SR4
Fan Tray 0	REV 04	740-035409	ACAE0875	Enhanced Fan Tray
Fan Tray 1	REV 04	740-035409	ACAE0876	Enhanced Fan Tray

show chassis hardware (with 20-Gigabit Ethernet MIC with SFP)

```

user@host> show chassis hardware
Hardware inventory:
Item          Version  Part number  Serial number  Description
Chassis              JN108DA5AAGA  SRX 5800
Midplane            REV 02  710-013698  TR0037        SRX 5600 Midplane
FPM Board           REV 02  710-014974  JY4635        Front Panel Display
PDM                 Rev 02  740-013110  QCS10465005  Power Distribution Module
PEM 0               Rev 03  740-023514  QCS11154040  PS 1.7kW; 200-240VAC in
PEM 2               Rev 02  740-023514  QCS10504014  PS 1.7kW; 200-240VAC in
Routing Engine 0    REV 05  740-015113  1000681023   RE-S-1300
CB 0                REV 05  710-013385  JY4775        SRX5k SCB
FPC 1               REV 17  750-020751  WZ6349        SRX5k DPC 4X 10GE
  CPU               REV 02  710-024633  WZ0718        SRX5k DPC PMB
  PIC 0             BUILTIN  BUILTIN       1x 10GE(LAN/WAN) RichQ
  Xcvr 0            NON-JNPR  C724XM088     XFP-10G-SR
  PIC 1             BUILTIN  BUILTIN       1x 10GE(LAN/WAN) RichQ
  Xcvr 0            REV 02  740-011571  C831XJ08S     XFP-10G-SR
  PIC 2             BUILTIN  BUILTIN       1x 10GE(LAN/WAN) RichQ
  PIC 3             BUILTIN  BUILTIN       1x 10GE(LAN/WAN) RichQ
FPC 3               REV 22  750-043157  ZH8189        SRX5k IOC II
  CPU               REV 06  711-043360  YX3912        SRX5k MPC PMB
  MIC 0             REV 01  750-055732  CACF9115      20x 1GE(LAN) SFP
  PIC 0             BUILTIN  BUILTIN       10x 1GE(LAN) SFP
  Xcvr 2            REV 02  740-013111  B358549       SFP-T
  Xcvr 9            REV 02  740-011613  PNB1FQS       SFP-SX
  PIC 1             BUILTIN  BUILTIN       10x 1GE(LAN) SFP
  Xcvr 9            REV 02  740-011613  PNB1FFF       SFP-SX
FPC 5               REV 01  750-027945  JW9665        SRX5k FIOC
  CPU
FPC 8               REV 08  750-023996  XA7234        SRX5k SPC
  CPU               REV 02  710-024633  XA1599        SRX5k DPC PMB
  PIC 0             BUILTIN  BUILTIN       SPU Cp-Flow
  PIC 1             BUILTIN  BUILTIN       SPU Flow

```

Fan Tray 0	REV 03	740-014971	TP0902	Fan Tray
Fan Tray 1	REV 01	740-014971	TP0121	Fan Tray

show chassis hardware (SRX5600 and SRX5800 devices with SRX5000 line SRX5K-SCBE [SCB2] and SRX5K-RE-1800X4 [RE2])

```
user@host> show chassis hardware
```

```
node0:
```

```
-----  
Hardware inventory:
```

Item	Version	Part number	Serial number	Description
Chassis			JN1251EA1AGB	SRX5600
Midplane	REV 01	760-063936	ACRE2657	Enhanced SRX5600 Midplane
FPM Board	REV 01	710-024631	CABY3551	Front Panel Display
PEM 0	Rev 03	740-034701	QCS13380901P	PS 1.4-2.6kW; 90-264V AC in
PEM 1	Rev 03	740-034701	QCS133809019	PS 1.4-2.6kW; 90-264V AC in
Routing Engine 0	REV 02	740-056658	9009210105	SRX5k RE-1800X4
Routing Engine 1	REV 02	740-056658	9013115551	SRX5k RE-1800X4
CB 0	REV 01	750-062257	CADW3663	SRX5k SCB3
CB 1	REV 01	750-062257	CADZ3263	SRX5k SCB3
FPC 0	REV 18	750-054877	CABG6043	SRX5k SPC II
CPU		BUILTIN	BUILTIN	SRX5k DPC PPC
PIC 0		BUILTIN	BUILTIN	SPU Cp
PIC 1		BUILTIN	BUILTIN	SPU Flow
PIC 2		BUILTIN	BUILTIN	SPU Flow
PIC 3		BUILTIN	BUILTIN	SPU Flow
FPC 1	REV 01	750-062243	CAEE5918	SRX5k IOC3 24XGE+6XLG
CPU	REV 02	711-062244	CADX8509	RMPC PMB
PIC 0		BUILTIN	BUILTIN	12x 10GE SFP+
Xcvr 0	REV 01	740-031980	273363A01891	SFP+-10G-SR
Xcvr 1	REV 01	740-031980	273363A01915	SFP+-10G-SR
Xcvr 2	REV 01	740-031980	ANA0BK6	SFP+-10G-SR
Xcvr 3	REV 01	740-031980	AP407GA	SFP+-10G-SR
Xcvr 9	REV 01	740-021308	MUC20G1	SFP+-10G-SR
PIC 1		BUILTIN	BUILTIN	12x 10GE SFP+
PIC 2		BUILTIN	BUILTIN	3x 40GE QSFP+
PIC 3		BUILTIN	BUILTIN	3x 40GE QSFP+
WAN MEZZ	REV 15	750-049136	CAEE5845	MPC5E 24XGE OTN Mezz
FPC 3	REV 11	750-043157	CACL7452	SRX5k IOC II
CPU	REV 04	711-043360	CACP1977	SRX5k MPC PMB
MIC 0	REV 04	750-049488	CABL4759	10x 10GE SFP+

PIC 0		BUILTIN	BUILTIN	10x 10GE SFP+
Xcvr 0	REV 01	740-021308	CF36KM0SY	SFP+-10G-SR
Xcvr 1	REV 01	740-021308	MUC0MF2	SFP+-10G-SR
Xcvr 2	REV 01	740-021308	CF36KM01S	SFP+-10G-SR
Xcvr 3	REV 01	740-021308	MUC229N	SFP+-10G-SR
FPC 5	REV 07	750-044175	CAAD0764	SRX5k SPC II
CPU		BUILTIN	BUILTIN	SRX5k DPC PPC
PIC 0		BUILTIN	BUILTIN	SPU Flow
PIC 1		BUILTIN	BUILTIN	SPU Flow
PIC 2		BUILTIN	BUILTIN	SPU Flow
PIC 3		BUILTIN	BUILTIN	SPU Flow
Fan Tray				Enhanced Fan Tray

node1:

Hardware inventory:

Item	Version	Part number	Serial number	Description
Chassis			JN124FE77AGB	SRX5600
Midplane	REV 01	760-063936	ACRE2970	Enhanced SRX5600 Midplane
FPM Board	REV 01	710-024631	CABY3552	Front Panel Display
PEM 0	Rev 03	740-034701	QCS133809028	PS 1.4-2.6kW; 90-264V AC in
PEM 1	Rev 03	740-034701	QCS133809027	PS 1.4-2.6kW; 90-264V AC in
Routing Engine 0	REV 02	740-056658	9009218294	SRX5k RE-1800X4
Routing Engine 1	REV 02	740-056658	9013104758	SRX5k RE-1800X4
CB 0	REV 01	750-062257	CAEB8180	SRX5k SCB3
CB 1	REV 01	750-062257	CADZ3334	SRX5k SCB3
FPC 0	REV 18	750-054877	CACJ9834	SRX5k SPC II
CPU		BUILTIN	BUILTIN	SRX5k DPC PPC
PIC 0		BUILTIN	BUILTIN	SPU Cp
PIC 1		BUILTIN	BUILTIN	SPU Flow
PIC 2		BUILTIN	BUILTIN	SPU Flow
PIC 3		BUILTIN	BUILTIN	SPU Flow
FPC 1	REV 01	750-062243	CAEB0981	SRX5k IOC3 24XGE+6XLG
CPU	REV 02	711-062244	CAEA4644	RMPC PMB
PIC 0		BUILTIN	BUILTIN	12x 10GE SFP+
Xcvr 0	REV 01	740-031980	AP41BLH	SFP+-10G-SR
Xcvr 1	REV 01	740-031980	AQ400SL	SFP+-10G-SR
Xcvr 2	REV 01	740-031980	AP422LJ	SFP+-10G-SR
Xcvr 3	REV 01	740-021308	AMG0RBT	SFP+-10G-SR
Xcvr 9	REV 01	740-021308	MUC2FRG	SFP+-10G-SR
PIC 1		BUILTIN	BUILTIN	12x 10GE SFP+
PIC 2		BUILTIN	BUILTIN	3x 40GE QSFP+
PIC 3		BUILTIN	BUILTIN	3x 40GE QSFP+

WAN MEZZ	REV 15	750-049136	CAEA4837	MPC5E 24XGE OTN Mezz
FPC 3	REV 11	750-043157	CACA8784	SRX5k IOC II
CPU	REV 04	711-043360	CACA8820	SRX5k MPC PMB
MIC 0	REV 05	750-049488	CADF0521	10x 10GE SFP+
PIC 0		BUILTIN	BUILTIN	10x 10GE SFP+
Xcvr 0	REV 01	740-030658	AD1130A00PV	SFP+-10G-USR
Xcvr 1	REV 01	740-031980	AN40MVV	SFP+-10G-SR
Xcvr 2	REV 01	740-021308	CF36KM37B	SFP+-10G-SR
Xcvr 3	REV 01	740-021308	AD153830DSZ	SFP+-10G-SR
MIC 1	REV 01	750-049487	CABB5961	2x 40GE QSFP+
PIC 2		BUILTIN	BUILTIN	2x 40GE QSFP+
Xcvr 1	REV 01	740-032986	QB160513	QSFP+-40G-SR4
FPC 5	REV 02	750-044175	ZY2569	SRX5k SPC II
CPU		BUILTIN	BUILTIN	SRX5k DPC PPC
PIC 0		BUILTIN	BUILTIN	SPU Flow
PIC 1		BUILTIN	BUILTIN	SPU Flow
PIC 2		BUILTIN	BUILTIN	SPU Flow
PIC 3		BUILTIN	BUILTIN	SPU Flow
Fan Tray				Enhanced Fan Tray

show chassis hardware (SRX5400, SRX5600, and SRX5800 devices with SRX5000 line SRX5K-SCB3 [SCB3] with enhanced midplanes and SRX5K-MPC3-100G10G [IOC3] or SRX5K-MPC3-40G10G [IOC3])

```

user@host> show chassis hardware
node0:
-----
Hardware inventory:
Item          Version  Part number  Serial number  Description
Chassis                               JN1250870AGB  SRX5600
Midplane      REV 01   760-063936  ACRE2578      Enhanced SRX5600
Midplane

FPM Board     REV 02   710-017254  KD9027        Front Panel Display
PEM 0         Rev 03   740-034701  QCS13090900T PS 1.4-2.6kW; 90-264V
A
              C in
PEM 1         Rev 03   740-034701  QCS13090904T PS 1.4-2.6kW; 90-264V
A
              C in
Routing Engine 0 REV 01   740-056658  9009196496    SRX5k RE-1800X4

```

CB 0	REV 01	750-062257	CAEC2501	SRX5k SCB3
FPC 0	REV 10	750-056758	CADC8067	SRX5k SPC II
CPU		BUILTIN	BUILTIN	SRX5k DPC PPC
PIC 0		BUILTIN	BUILTIN	SPU Cp
PIC 1		BUILTIN	BUILTIN	SPU Flow
PIC 2		BUILTIN	BUILTIN	SPU Flow
PIC 3		BUILTIN	BUILTIN	SPU Flow
FPC 2	REV 01	750-062243	CAEE5924	SRX5k IOC3 24XGE+6XLG
CPU	REV 01	711-062244	CAEB4890	SRX5k IOC3 PMB
PIC 0		BUILTIN	BUILTIN	12x 10GE SFP+
PIC 1		BUILTIN	BUILTIN	12x 10GE SFP+
PIC 2		BUILTIN	BUILTIN	3x 40GE QSFP+
Xcvr 0	REV 01	740-038623	MOC13156230449	QSFP+-40G-CU1M
Xcvr 2	REV 01	740-038623	MOC13156230449	QSFP+-40G-CU1M
PIC 3		BUILTIN	BUILTIN	3x 40GE QSFP+
WAN MEZZ	REV 01	750-062682	CAEE5817	24x 10GE SFP+ Mezz
FPC 4	REV 11	750-043157	CACY1595	SRX5k IOC II
CPU	REV 04	711-043360	CACZ8879	SRX5k MPC PMB
MIC 1	REV 04	750-049488	CACM6062	10x 10GE SFP+
PIC 2		BUILTIN	BUILTIN	10x 10GE SFP+
Xcvr 7	REV 01	740-021308	AD1439301TU	SFP+-10G-SR
Xcvr 8	REV 01	740-021308	AD1439301SD	SFP+-10G-SR
Xcvr 9	REV 01	740-021308	AD1439301TS	SFP+-10G-SR
FPC 5	REV 05	750-044175	ZZ1371	SRX5k SPC II
CPU		BUILTIN	BUILTIN	SRX5k DPC PPC
PIC 0		BUILTIN	BUILTIN	SPU Flow
PIC 1		BUILTIN	BUILTIN	SPU Flow
PIC 2		BUILTIN	BUILTIN	SPU Flow
PIC 3		BUILTIN	BUILTIN	SPU Flow
Fan Tray				Enhanced Fan Tray

node1:

Hardware inventory:

Item	Version	Part number	Serial number	Description
Chassis			JN124FEC0AGB	SRX5600
Midplane	REV 01	760-063936	ACRE2946	Enhanced SRX5600 Midplane
FPM Board	test	710-017254	test	Front Panel Display
PEM 0	Rev 01	740-038514	QCS114111003	DC 2.6kW Power Entry Module
PEM 1	Rev 01	740-038514	QCS12031100J	DC 2.6kW Power Entry Module
Routing Engine 0	REV 01	740-056658	9009186342	SRX5k RE-1800X4
CB 0	REV 01	750-062257	CAEB8178	SRX5k SCB3
FPC 0	REV 07	750-044175	CAAD0769	SRX5k SPC II

CPU		BUILTIN	BUILTIN	SRX5k DPC PPC
PIC 0		BUILTIN	BUILTIN	SPU Cp
PIC 1		BUILTIN	BUILTIN	SPU Flow
PIC 2		BUILTIN	BUILTIN	SPU Flow
PIC 3		BUILTIN	BUILTIN	SPU Flow
FPC 4	REV 11	750-043157	CACY1592	SRX5k IOC II
CPU	REV 04	711-043360	CACZ8831	SRX5k MPC PMB
MIC 1	REV 04	750-049488	CACN0239	10x 10GE SFP+
PIC 2		BUILTIN	BUILTIN	10x 10GE SFP+
Xcvr 7	REV 01	740-031980	ARN23HW	SFP+-10G-SR
Xcvr 8	REV 01	740-031980	ARN2FVW	SFP+-10G-SR
Xcvr 9	REV 01	740-031980	ARN2YVM	SFP+-10G-SR
FPC 5	REV 10	750-056758	CADA8736	SRX5k SPC II
CPU		BUILTIN	BUILTIN	SRX5k DPC PPC
PIC 0		BUILTIN	BUILTIN	SPU Flow
PIC 1		BUILTIN	BUILTIN	SPU Flow
PIC 2		BUILTIN	BUILTIN	SPU Flow
PIC 3		BUILTIN	BUILTIN	SPU Flow
Fan Tray				Enhanced Fan Tray

show chassis hardware (SRX4200)

command-name

```
user@host> show chassis hardware
```

```
Hardware inventory:
```

Item	Version	Part number	Serial number	Description
Chassis			DK2816AR0020	SRX4200
Mainboard	REV 01	650-071675	16061032317	SRX4200
Routing Engine 0		BUILTIN	BUILTIN	SRX Routing Engine
FPC 0		BUILTIN	BUILTIN	FEB
PIC 0		BUILTIN	BUILTIN	8x10G-SFP
Xcvr 0	REV 01	740-038153	MOC11511530020	SFP+-10G-CU3M
Xcvr 1	REV 01	740-038153	MOC11511530020	SFP+-10G-CU3M
Xcvr 2	REV 01	740-038153	MOC11511530020	SFP+-10G-CU3M
Xcvr 3	REV 01	740-038153	MOC11511530020	SFP+-10G-CU3M
Xcvr 4	REV 01	740-021308	04DZ06A00364	SFP+-10G-SR
Xcvr 5	REV 01	740-031980	233363A03066	SFP+-10G-SR

Xcvr 6	REV 01	740-021308	AL70SWE	SFP+-10G-SR
Xcvr 7	REV 01	740-031980	ALN0N6C	SFP+-10G-SR
Xcvr 8	REV 01	740-030076	APF16220018NK1	SFP+-10G-CU1M
Power Supply 0	REV 04	740-041741	1GA26241849	JPSU-650W-AC-AFO
Power Supply 1	REV 04	740-041741	1GA26241846	JPSU-650W-AC-AFO
Fan Tray 0				SRX4200 0, Front to Back Airflow - AFO
Fan Tray 1				SRX4200 1, Front to Back Airflow - AFO
Fan Tray 2				SRX4200 2, Front to Back Airflow - AFO
Fan Tray 3				SRX4200 3, Front to Back Airflow - AFO

show chassis hardware (vSRX Virtual Firewall 3.0)

command-name

```

user@host> show chassis hardware
Hardware inventory:
Item          Version  Part number  Serial number  Description
Chassis                               806dddb1a141  VSRX
Midplane
System IO
Routing Engine                          VSRX-2CPU-8G memory
FPC 0                                       FPC
  PIC 0                                    VSRX DPKD GE
Power Supply 0

```

show chassis hardware clei-models

show chassis hardware clei-models (SRX5600 and SRX5800 devices with SRX5000 line SRX5K-SCBE [SCB2] and SRX5K-RE-1800X4 [RE2])

```

user@host> show chassis hardware clei-models node 1
node1:
-----
Hardware inventory:
Item          Version  Part number  CLEI code      FRU model number

```

Midplane	REV 01	710-024803		SRX5800-BP-A
FPM Board	REV 01	710-024632		SRX5800-CRAFT-A
PEM 0	Rev 04	740-034724		SRX5800-PWR-4100-AC
PEM 1	Rev 05	740-034724		SRX5800-PWR-4100-AC
Routing Engine 0	REV 01	740-056658	COUCATTBAA	SRX5K-RE-1800X4
CB 0	REV 01	750-056587	COUCATSBAA	SRX5K-SCBE
CB 1	REV 01	750-056587	COUCATSBAA	SRX5K-SCBE
CB 2	REV 01	750-056587	COUCATSBAA	SRX5K-SCBE
FPC 0	REV 18	750-054877	COUCATLBAA	SRX5K-SPC-4-15-320
CPU		BUILTIN		
FPC 1	REV 18	750-054877	COUCATLBAA	SRX5K-SPC-4-15-320
CPU		BUILTIN		
FPC 2	REV 18	750-054877	COUCATLBAA	SRX5K-SPC-4-15-320
CPU		BUILTIN		
FPC 3	REV 11	750-043157	COUIBCWBAA	SRX5K-MPC
MIC 0	REV 05	750-049486	COUIBCYBAA	SRX-MIC-1X100G-CFP
MIC 1	REV 04	750-049488	COUIBCXBAA	SRX-MIC-10XG-SFPP
FPC 4	REV 18	750-054877	COUCATLBAA	SRX5K-SPC-4-15-320
CPU		BUILTIN		
FPC 7	REV 18	750-054877	COUCATLBAA	SRX5K-SPC-4-15-320
CPU		BUILTIN		
FPC 8	REV 11	750-043157	COUIBCWBAA	SRX5K-MPC
MIC 0	REV 05	750-049486	COUIBCYBAA	SRX-MIC-1X100G-CFP
FPC 9	REV 18	750-054877	COUCATLBAA	SRX5K-SPC-4-15-320
CPU		BUILTIN		
FPC 10	REV 18	750-054877	COUCATLBAA	SRX5K-SPC-4-15-320
CPU		BUILTIN		
Fan Tray 0	REV 04	740-035409		SRX5800-HC-FAN
Fan Tray 1	REV 04	740-035409		SRX5800-HC-FAN

Release Information

Command introduced in Junos OS Release 9.2. Command modified in Junos OS Release 9.2 to include node option.

RELATED DOCUMENTATION

[Understanding Traffic Processing on Security Devices](#)

[Interface Naming Conventions](#)

show chassis pic (Security)

IN THIS SECTION

- [Syntax | 530](#)
- [Description | 530](#)
- [Options | 530](#)
- [Required Privilege Level | 531](#)
- [Output Fields | 531](#)
- [Sample Output | 532](#)
- [Release Information | 533](#)

Syntax

```
show chassis pic fpc-slot slot-number pic-slot slot-number
```

Description

Display status information about the PIC installed in the specified Flexible PIC Concentrator (FPC) and PIC slot.

Options

- | | |
|------------------------------------|--|
| fpc-slot <i>slot-number</i> | Display information about the FPC in the slot. |
| pic-slot <i>slot-number</i> | Display information about the PIC in this particular FPC slot. |

Required Privilege Level

view

Output Fields

[Table 27 on page 531](#) lists the output fields for the `show chassis pic` command. Output fields are listed in the approximate order in which they appear.

Table 27: show chassis pic Output Fields

Field Name	Field Description
Type	PIC type.
State	Status of the PIC. State is displayed only when a PIC is in the slot. <ul style="list-style-type: none"> • Online— PIC is online and running. • Offline—PIC is powered down.
PIC version	PIC hardware version.
Uptime	How long the PIC has been online.
Port Number	Port number for the PIC.
Cable Type	Type of cable connected to the port: LH, LX, or SX.

Table 27: show chassis pic Output Fields (Continued)

Field Name	Field Description
PIC Port Information	Port-level information for the PIC. <ul style="list-style-type: none"> • Port—Port number • Cable type—Type of transceiver installed. • Fiber type—Type of fiber. • Xcvr vendor—Transceiver vendor name. • Xcvr vendor part number—Transceiver vendor part number. • Wavelength—Wavelength of the transmitted signal.

Sample Output

show chassis pic fpc-slot pic-slot

```

user@host> show chassis pic fpc-slot 10 pic-slot 0
FPC slot 10, PIC slot 0 information:
  Type                10x 10GE SFP+
  State                Online
  PIC version          1.1
  Uptime               6 days, 7 hours, 29 minutes, 28 seconds

PIC port information:
  Port  Cable type      Fiber      Xcvr vendor      Xcvr vendor      Wavelength
  0     10GBASE SR          type Xcvr vendor      part number
  MM   FINISAR CORP.    FTLX8571D3BNL-J1  850 nm

  Xcvr vendor
  firmware version
  0.0

PIC port information:
  Fiber      Xcvr vendor

```

```
Port Cable type      type Xcvr vendor      part number      Wavelength
1    10GBASE SR        MM  FINISAR CORP.   FTLX8571D3BNL-J1 850 nm

Xcvr vendor
firmware version
0.0
```

Release Information

Command introduced in Junos OS Release 9.2.

RELATED DOCUMENTATION

[Interfaces User Guide for Security Devices](#)

[Understanding Traffic Processing on Security Devices | 2](#)

show chassis power

IN THIS SECTION

- [Syntax | 534](#)
- [Description | 534](#)
- [Options | 534](#)
- [Required Privilege Level | 534](#)
- [Output Fields | 534](#)
- [Sample Output | 536](#)
- [Release Information | 538](#)

Syntax

```
show chassis power
```

Description

Display power limits and usage information for the Power Entry Modules (PEMs).

Options

node	Displays information specific to the chassis.
sequence	Shows the chassis fru power on sequence.

Required Privilege Level

view

Output Fields

[Table 28 on page 535](#) lists the output fields for the `show chassis power` command. Output fields are listed in the approximate order in which they appear.

Table 28: show chassis power Output Fields

Field Name	Field Description
PEM number	<p>AC or DC PEM number on the chassis. The following output fields are displayed for the PEM:</p> <ul style="list-style-type: none"> • State—State of the PEM: <ul style="list-style-type: none"> • Online—PEM is present in the slot and online. • Empty—PEM is not present in the slot. • Present—PEM is present in the slot, but not online. • AC Input —State of the AC input power feed with the number of active and expected feeds (1 or 2). • Capacity—Actual power input capacity with maximum capacity displayed (in parentheses) in watts. • DC Output—DC power output, in watts, for the specified zone, at the specified amps and voltage (A @ V), and load and percentage utilization of the maximum capacity for the zone.
System	<p>Overall power statistics for the system zone:</p> <ul style="list-style-type: none"> • Zone number: <ul style="list-style-type: none"> • Capacity—Maximum power capacity available for the zone, in watts. • Allocated power—Actual capacity allocated for the zone, in watts, with remaining power displayed in parentheses. • Actual usage—Actual power usage for the zone, in watts. • Total system capacity—Cumulative power capacity of all the zones, in watts. • Total remaining capacity—Difference between the total system capacity and cumulative allocated power of all zones, in watts.

Sample Output

show chassis power

When you enter the **show chassis power** command, the sample output is shown for DC PEM.

```
user@host> show chassis power
node0:
-----

PEM 0:
  State:      Online
  DC input:   OK (1 feed expected, 1 feed connected)
  Capacity:   2440 W (maximum 2440 W)
  DC output:  600 W (zone 0, 12 A at 50 V, 24% of capacity)

PEM 1:
  State:      Online
  DC input:   OK (1 feed expected, 1 feed connected)
  Capacity:   2440 W (maximum 2440 W)
  DC output:  1550 W (zone 1, 31 A at 50 V, 63% of capacity)

PEM 2:
  State:      Empty
  Input:      Absent

PEM 3:
  State:      Empty
  Input:      Absent

System:
  Zone 0:
    Capacity:      2440 W (maximum 2440 W)
    Allocated power: 1050 W (1390 W remaining)
    Actual usage:   600 W
  Zone 1:
    Capacity:      2440 W (maximum 2440 W)
    Allocated power: 2310 W (130 W remaining)
    Actual usage:   1550 W
  Total system capacity: 4880 W (maximum 4880 W)
  Total remaining power: 1520 W
```

node1:

PEM 0:

State: Online
DC input: OK (1 feed expected, 1 feed connected)
Capacity: 2440 W (maximum 2440 W)
DC output: 600 W (zone 0, 12 A at 50 V, 24% of capacity)

PEM 1:

State: Online
DC input: OK (1 feed expected, 1 feed connected)
Capacity: 2440 W (maximum 2440 W)
DC output: 1519 W (zone 1, 31 A at 49 V, 62% of capacity)

PEM 2:

State: Empty
Input: Absent

PEM 3:

State: Empty
Input: Absent

System:

Zone 0:

Capacity: 2440 W (maximum 2440 W)
Allocated power: 1050 W (1390 W remaining)
Actual usage: 600 W

Zone 1:

Capacity: 2440 W (maximum 2440 W)
Allocated power: 2310 W (130 W remaining)
Actual usage: 1519 W

Total system capacity: 4880 W (maximum 4880 W)

Total remaining power: 1520 W

show chassis power detail

When you enter the **show chassis power detail** command, the sample output is shown for DC PEM.

```
user@host> show chassis power detail
PEM 0:
  State:      Online
  Capacity:   1600 W (maximum 1600 W)
  DC output:  240 W (zone 0, 20 A at 12 V, 8% of capacity)

PEM 1:
  State:      Online
  Capacity:   1600 W (maximum 1600 W)
  DC output:  204 W (zone 0, 17 A at 12 V, 7% of capacity)

System:
  Zone 0:
    Capacity:      3200 W (maximum 3200 W)
    Allocated power: 1000 W (2200 W remaining)
    Actual usage:   444 W
  Total system capacity: 3200 W (maximum 3200 W)
  Total remaining power: 2200 W

Item                Used(W)
Fan Tray 0          0
Fan Tray 1          0
Fan Tray 2          0
Fan Tray 3          0
Fan Tray 4          0
RE0/CB0             0
FPC 0               0
FPC 1               0
```

Release Information

Command modified in Junos OS Release 12.1X44-D10.

RELATED DOCUMENTATION

[Understanding Traffic Processing on Security Devices | 2](#)

show chassis power sequence

show firewall (View)

IN THIS SECTION

- [Syntax | 539](#)
- [Description | 539](#)
- [Options | 540](#)
- [Required Privilege Level | 540](#)
- [Output Fields | 540](#)
- [Sample Output | 541](#)
- [Release Information | 542](#)

Syntax

```
show firewall
<filter filter-name>
<counter counter-name>
<log>
<prefix-action-stats>
<terse>
```

Description

Display statistics about configured firewall filters.

Options

<code>none</code>	Display statistics about configured firewall filters.
<code>filter <i>filter-name</i></code>	Name of a configured filter.
<code>counter <i>counter-name</i></code>	Name of a filter counter.
<code>log</code>	Display log entries for firewall filters.
<code>prefix-action-stats</code>	Display prefix action statistics for firewall filters.
<code>terse</code>	Display firewall filter names only.

Required Privilege Level

view

Output Fields

[Table 29 on page 540](#) lists the output fields for the `show firewall` command. Output fields are listed in the approximate order in which they appear.

Table 29: show firewall Output Fields

Field Name	Field Description
Filter	<p>Name of a filter that has been configured with the <code>filter</code> at the <code>[edit firewall]</code> hierarchy level.</p> <p>When an interface-specific filter is displayed, the name of the filter is followed by the full interface name and by either <code>-i</code> for an input filter or <code>-o</code> for an output filter.</p> <p>When dynamic filters are displayed, the name of the filter is followed by the full interface name and by either <code>-in</code> for an input filter or <code>-out</code> for an output filter. When a logical system-specific filter is displayed, the name of the filter is prefixed with two underscore (<code>__</code>) characters and the name of the logical system (for example, <code>__ls1/filter1</code>).</p>

Table 29: show firewall Output Fields (Continued)

Field Name	Field Description
Counters	<p>Display filter counter information:</p> <ul style="list-style-type: none"> • Name—Name of a filter counter that has been configured with the counter firewall filter action. • Bytes—Number of bytes that match the filter term under which the counter action is specified. • Packets—Number of packets that matched the filter term under which the counter action is specified.
Policers	<p>Display policer information:</p> <ul style="list-style-type: none"> • Name—Name of policer. • Bytes—Number of bytes that match the filter term under which the policer action is specified. This is only the number out-of-specification (out-of-spec) byte counts, not all the bytes in all packets policed by the policer. • Packets—Number of packets that matched the filter term under which the policer action is specified. This is only the number of out-of-specification (out-of-spec) packet counts, not all packets policed by the policer.

Sample Output

show firewall

```

user@host> show firewall
Filter: ef_path
Counters:
Name                Bytes      Packets
def-count           0          0
video-count         0          0
voice-count         0          0

Filter: __default_bpdu_filter__

```

Filter: deep

Counters:

Name	Bytes	Packets
deep2	302076	5031

Filter: deep-flood

Counters:

Name	Bytes	Packets
deep_flood_def	302136	5032
deep1	0	0

Policers:

Name	Packets
deep-pol-op-first	0

Release Information

Command introduced before Junos OS Release 10.0 .

RELATED DOCUMENTATION

| *firewall*

show interfaces (View Aggregated Ethernet)

IN THIS SECTION

- [Syntax | 543](#)
- [Description | 543](#)
- [Options | 543](#)
- [Required Privilege Level | 544](#)
- [Output Fields | 544](#)

- [Sample Output | 555](#)
- [Release Information | 558](#)

Syntax

```
show interfaces <aenumber | rethnumber >  
<brief | detail | extensive | terse>  
<descriptions>  
<media>  
<snmp-index snmp-index>  
<statistics>
```

Description

Display status information about the specified aggregated Ethernet interface or redundant Ethernet interface. If you do not specify an interface name, status information for all interfaces is displayed.

NOTE: This command only provides interface statistics for a redundant ethernet interface (reth) when executed on the node which has the active members/links of the redundant ethernet interface.

Options

- *aenumber* | *rethnumber*—(Optional) Display standard information about the specified aggregated Ethernet interface or redundant Ethernet interface.
- *brief* | *detail* | *extensive* | *terse*—(Optional) Display the specified level of output.
- *descriptions*—(Optional) Display interface description strings.
- *media*—(Optional) Display media-specific information.

- `snmp-index snmp-index`—(Optional) Display information for the specified SNMP index of the interface.
- `statistics`—(Optional) Display static interface statistics.

Required Privilege Level

view

Output Fields

[Table 30 on page 544](#) lists the output fields for the `show interfaces (Aggregated Ethernet)` command. Output fields are listed in the approximate order in which they appear.

Table 30: Aggregated Ethernet show interfaces Output Fields

Field Name	Field Description	Level of Output
Physical Interface		
Physical interface	Name of the physical interface and state of the interface.	All levels
Enabled	State of the physical interface.	All levels
Interface index	Index number of the physical interface, which reflects its initialization sequence.	All levels
SNMP ifIndex	SNMP index number for the physical interface.	detail extensive none
Generation	Unique number for use by Juniper Networks technical support only.	detail extensive
Link-level type	Encapsulation being used on the physical interface.	All levels

Table 30: Aggregated Ethernet show interfaces Output Fields (Continued)

Field Name	Field Description	Level of Output
MTU	Maximum transmission unit size on the physical interface.	All levels
Speed	Speed at which the interface is running.	All levels
Loopback	Loopback status: Enabled or Disabled. If loopback is enabled, type of loopback: Local or Remote.	All levels
Source filtering	Source filtering status: Enabled or Disabled.	All levels
Flow control	Flow control status: Enabled or Disabled.	All levels
Minimum links needed	Number of child links that must be operational for the aggregate interface to be operational.	All levels
Device flags	Information about the physical device.	All levels
Interface flags	Information about the interface.	All levels
Current address	Configured MAC address.	detail extensive
Hardware address	Hardware MAC address.	detail extensive
Last flapped	Date, time, and how long ago the interface went from down to up or up to down. The format is Last flapped: <i>year-month-day hours:minutes:seconds timezone (hours:minutes:seconds ago)</i> . For example, Last flapped: 2002-04-26 10:52:40 PDT (04:33:20 ago).	detail extensive
Input Rate	Input rate in bits per second (bps) and packets per second (pps).	None specified
Output Rate	Output rate in bps and pps.	None specified

Table 30: Aggregated Ethernet show interfaces Output Fields (Continued)

Field Name	Field Description	Level of Output
Statistics last cleared	Time when the statistics for the interface were last set to zero.	detail extensive
Traffic statistics	<p>Number and rate of bytes and packets received and transmitted on the physical interface.</p> <ul style="list-style-type: none"> • Input bytes—Number of bytes received on the interface. • Output bytes—Number of bytes transmitted on the interface. • Input packets—Number of packets received on the interface • Output packets—Number of packets transmitted on the interface. 	detail extensive
IPv6 transit statistics	<p>Number of IPv6 transit bytes and packets received and transmitted on the physical interface if IPv6 statistics tracking is enabled.</p> <ul style="list-style-type: none"> • Input bytes—Number of bytes received on the interface. • Output bytes—Number of bytes transmitted on the interface. • Input packets—Number of packets received on the interface. • Output packets—Number of packets transmitted on the interface. 	detail extensive

Table 30: Aggregated Ethernet show interfaces Output Fields (Continued)

Field Name	Field Description	Level of Output
Input errors	<p data-bbox="446 357 747 388">Input errors on the interface:</p> <ul style="list-style-type: none"> <li data-bbox="446 420 1104 493">• Errors—Sum of incoming frame terminates and frame check sequence (FCS) errors. <li data-bbox="446 525 1185 661">• Drops—Number of packets dropped by the input queue of the I/O Manager ASIC. If the interface is saturated, this number increments once for every packet that is dropped by the ASIC's RED mechanism. <li data-bbox="446 693 1153 724">• Framing errors—Number of packets received with an invalid FCS. <li data-bbox="446 756 1153 829">• Runts—Number of frames received that are smaller than the runt threshold. <li data-bbox="446 861 1153 934">• Giants—Number of frames received that are larger than the giant threshold. <li data-bbox="446 966 1193 1102">• Policed discards—Number of frames that the incoming packet match code discarded because they were not recognized or not of interest. Usually, this field reports protocols that the Junos OS does not handle. <li data-bbox="446 1134 893 1165">• Resource errors—Sum of transmit drops. 	detail extensive

Table 30: Aggregated Ethernet show interfaces Output Fields (Continued)

Field Name	Field Description	Level of Output
Output errors	<p>Output errors on the interface. The following paragraphs explain the counters whose meaning might not be obvious:</p> <ul style="list-style-type: none"> • Carrier transitions—Number of times the interface has gone from down to up. This number does not normally increment quickly, increasing only when the cable is unplugged, the far-end system is powered down and then up, or another problem occurs. If the number of carrier transitions increments quickly (perhaps once every 10 seconds), the cable, the far-end system, or the PIC is malfunctioning. • Errors—Sum of the outgoing frame terminates and FCS errors. • Drops—Number of packets dropped by the output queue of the I/O Manager ASIC. If the interface is saturated, this number increments once for every packet that is dropped by the ASIC's RED mechanism. • MTU errors—Number of packets whose size exceeded the MTU of the interface. • Resource errors—Sum of transmit drops. 	detail extensive
Egress queues	Total number of egress queues supported on the specified interface	detail extensive
Queue counters	<p>CoS queue number and its associated user-configured forwarding class name.</p> <ul style="list-style-type: none"> • Queued packets—Number of queued packets. • Transmitted packets—Number of transmitted packets. • Dropped packets—Number of packets dropped by the ASIC's RED mechanism. 	detail extensive
Logical Interface		
Logical interface	Name of the logical interface.	All levels

Table 30: Aggregated Ethernet show interfaces Output Fields (Continued)

Field Name	Field Description	Level of Output
Index	Index number of the logical interface (which reflects its initialization sequence).	detail extensive none
SNMP ifIndex	SNMP interface index number of the logical interface.	detail extensive none
Generation	Unique number for use by Juniper Networks technical support only.	detail extensive
Flags	Information about the logical interface.	All levels
VLAN-Tag	Tag Protocol Identifier (TPID) and VLAN identifier.	All levels
Demux	IP demultiplexing (demux) value that appears if this interface is used as the demux underlying interface. The output is one of the following: <ul style="list-style-type: none"> • Source Family Inet • Destination Family Inet 	detail extensive none
Encapsulation	Encapsulation on the logical interface.	All levels
Statistics	Information about the number of packets, packets per second, number of bytes, and bytes per second on this aggregate interface. <ul style="list-style-type: none"> • Bundle—Information about input and output bundle rates. • Link—(detail and extensive only) Information about specific links in the aggregate, including link state and input and output rates. 	detail extensive none

Table 30: Aggregated Ethernet show interfaces Output Fields (Continued)

Field Name	Field Description	Level of Output
LACP info	<p>Link Aggregation Control Protocol (LACP) information for each aggregated interface.</p> <ul style="list-style-type: none"> • Role can be one of the following: <ul style="list-style-type: none"> • Actor—Local device participating in LACP negotiation. • Partner—Remote device participating in LACP negotiation. • System priority—Priority assigned to the system (by management or administrative policy), encoded as an unsigned integer. • System identifier—Actor or partner system ID, encoded as a MAC address. • Port priority—Priority assigned to the port by the actor or partner (by management or administrative policy), encoded as an unsigned integer. • Port number—Port number assigned to the port by the actor or partner, encoded as an unsigned integer. • Port key—Operational key value assigned to the port by the actor or partner, encoded as an unsigned integer. 	detail extensive none
LACP Statistics	<p>LACP statistics for each aggregated interface.</p> <ul style="list-style-type: none"> • LACP Rx—LACP received counter that increments for each normal hello. • LACP Tx—Number of LACP transmit packet errors logged. • Unknown Rx—Number of unrecognized packet errors logged. • Illegal Rx—Number of invalid packets received. 	detail extensive none

Table 30: Aggregated Ethernet show interfaces Output Fields (Continued)

Field Name	Field Description	Level of Output
Marker Statistic	<p>(detail and extensive only) Information about 802.3ad marker protocol statistics on the specified links.</p> <ul style="list-style-type: none"> • Marker Rx—Number of valid marker PDUs received on this aggregation port. • Resp Tx—Number of marker response PDUs transmitted on this aggregation port. • Unknown Rx—Number of frames received that either carry the slow protocols Ethernet type value (43B.4) but contain an unknown protocol data unit (PDU), or are addressed to the slow protocols group MAC address (43B.3) but do not carry the slow protocols Ethernet type. • Illegal Rx—Number of frames received that carry the slow protocols Ethernet type value (43B.4) but contain a badly formed PDU or an illegal value of protocol subtype (43B.4). 	detail extensive none
Flow Statistics	Flow statistics for each aggregated interface.	detail extensive none
Flow Input statistics	Statistics for packets received by the flow module.	detail extensive none
Flow Output statistics	Statistics for packets sent by the flow module.	detail extensive none

Table 30: Aggregated Ethernet show interfaces Output Fields (Continued)

Field Name	Field Description	Level of Output
Flow error statistics (Packets dropped due to)	<p>Packet drop statistics for the flow module.</p> <ul style="list-style-type: none"> • Address spoofing—Packet dropped when the screen module detected address spoofing. • Authentication failed—Packet dropped because the IPsec Encapsulating Security Payload (ESP) or Authentication Header (AH) authentication failed. • Incoming NAT errors—Packet dropped because the source NAT rule search failed, an invalid source NAT binding was found, or the NAT allocation failed. • Invalid zone received packet—This counter is not currently in use. • Multiple user authentications—Packet dropped if it matches more than one policy that specifies user authentication. (Sometimes packets are looped through the system more than once. Each time a packet passes through the system, that packet must be permitted by a policy.) • Multiple incoming NAT—Packet dropped if source NAT is specified more than once. (Sometimes packets are looped through the system more than once.) • No parent for a gate—This counter is not currently in use. • No one interested in self packets—This counter is incremented for one of the following reasons: <ul style="list-style-type: none"> • The outbound interface is a self interface, but the packet is not marked as a to-self packet and the destination address is in a source NAT pool. • No service is interested in the to-self packet • When a zone has ident-reset service enabled, the TCP RST to IDENT request for port 113 is sent back and this counter is incremented. 	detail extensive none

Table 30: Aggregated Ethernet show interfaces Output Fields (Continued)

Field Name	Field Description	Level of Output
Flow error statistics (Packets dropped due to)	<p>Packet drop statistics for the flow module (continued).</p> <ul style="list-style-type: none"> • No minor session—Packet dropped because no minor sessions are available and a minor session was requested. Minor sessions are allocated for storing additional TCP state information. • No more sessions—Packet dropped because there were no more free sessions available. • No NAT gate—This counter is not currently in use. • No route present—Packet dropped because a valid route was not available to forward the packet. • No SA for incoming SPI—Packet dropped because the incoming IPsec packet's security parameter index (SPI) does not match any known SPI. • No tunnel found—Packet dropped because a valid tunnel could not be found. • No session for a gate—Packet dropped by an ALG. • No zone or NULL zone binding—Packet dropped because its incoming interface was not bound to any zone. • Policy denied—The error counter is incremented for one of the following reasons: <ul style="list-style-type: none"> • Source or destination NAT (or both) has occurred and policy says to drop the packet. • Policy specifies user authentication, which failed. • Policy was configured to deny this packet. • Security association not active—Packet dropped because an IPsec packet was received for an inactive SA. • TCP sequence number out of window—TCP packet with a sequence number failed the TCP sequence number check that was received. 	detail extensive none

Table 30: Aggregated Ethernet show interfaces Output Fields (Continued)

Field Name	Field Description	Level of Output
	<ul style="list-style-type: none"> • Syn-attack protection—Packet dropped because of SYN attack protection or SYN cookie protection. • User authentication errors—Packet dropped because policy requires authentication; however: <ul style="list-style-type: none"> • Only Telnet, FTP, and HTTP traffic can be authenticated. • The corresponding authentication entry could not be found, if web-auth is specified. • The maximum number of authenticated sessions per user was exceeded. 	
<i>protocol-family</i>	Protocol family configured on the logical interface.	brief
Protocol	Protocol family configured on the logical interface.	detail extensive none
MTU	Maximum transmission unit size on the logical interface.	detail extensive none
Maximum labels	Maximum number of MPLS labels configured for the MPLS protocol family on the logical interface.	detail extensive none
Generation	Unique number for use by Juniper Networks technical support only.	detail extensive
Route Table	Routing table in which the logical interface address is located. For example, 0 refers to the routing table inet.0.	detail extensive
Flags	Information about protocol family flags.	detail extensive none
Mac-Validate Failures	Number of MAC address validation failures for packets and bytes. This field is displayed when MAC address validation is enabled for the logical interface.	detail extensive none

Table 30: Aggregated Ethernet show interfaces Output Fields (Continued)

Field Name	Field Description	Level of Output
Addresses, Flags	Information about address flags.	detail extensive none
Destination	IP address of the remote side of the connection.	detail extensive none
Local	IP address of the logical interface.	detail extensive none
Broadcast	Broadcast address of the logical interface.	detail extensive none
Policer	Policer to be evaluated when packets are received or transmitted on the interface.	detail extensive none
Generation	Unique number for use by Juniper Networks technical support only.	detail extensive
BFD View	Number of child interfaces that bind with an Aggregated Ethernet and the details about each of the child interface.	detail extensive

Sample Output

show interfaces extensive (Aggregated Ethernet)

```
user@host> show interfaces ae0 extensive
```

```
Physical interface: ae0, Enabled, Physical link is Up
  Interface index: 129, SNMP ifIndex: 511, Generation: 132
  Description: peering_circuit_1
  Link-level type: Ethernet, MTU: 9192, Speed: 300Gbps, BPDU Error: None, MAC-REWRITE Error:
  None, Loopback: Disabled, Source filtering: Disabled, Flow control: Disabled
  Pad to minimum frame size: Disabled
```

```

Minimum links needed: 1, Minimum bandwidth needed: 1bps
Device flags   : Present Running
Interface flags: SNMP-Traps Internal: 0x4000
Current address: d6:04:ff:61:b8:34, Hardware address: d6:04:ff:61:b8:34
Last flapped   : 2021-12-28 05:29:46 AST (12w0d 17:21 ago)
Statistics last cleared: Never
Traffic statistics:
  Input bytes   : 11536008239086728      15907122832 bps
  Output bytes  : 79363162639161356     94333055640 bps
  Input packets: 34243932723902         6000894 pps
  Output packets: 71090422616807       10394710 pps
IPv6 transit statistics:
  Input bytes   : 132607566
  Output bytes  : 64814847
  Input packets: 1214245
  Output packets: 205780
Label-switched interface (LSI) traffic statistics:
  Input bytes   : 0                      0 bps
  Input packets: 0                      0 pps
Dropped traffic statistics due to STP State:
  Input bytes   : 0
  Output bytes  : 0
  Input packets: 0
  Output packets: 0
MAC statistics:
  Broadcast packets  Receive  Transmit
  Multicast packets  507930812  508053261
Input errors:
  Errors: 3, Drops: 0, Framing errors: 3, Runts: 0, Giants: 0, Policed discards: 0, Resource
errors: 0
Output errors:
  Carrier transitions: 1, Errors: 1, Drops: 0, MTU errors: 0, Resource errors: 0
Ingress queues: 8 supported, 6 in use
Queue counters:
  Queued packets  Transmitted packets  Dropped packets
  0               0                   0                 0
  1               0                   0                 0
  2               0                   0                 0
  3               0                   0                 0
  4               0                   0                 0
  5               0                   0                 0
Egress queues: 8 supported, 6 in use
Queue counters:
  Queued packets  Transmitted packets  Dropped packets
  0               71060094226903     71060094226903   0

```

1	22965705	22965705	0
2	685726357	685726357	0
3	663839376	663839376	0
4	29235543467	29235543467	0
5	223155458	223155458	0

Queue number: Mapped forwarding classes

0	BEST-EFFORT
1	PREMIUM-DATA
2	BUSINESS
3	NC
4	VIDEO
5	VOICE

Logical interface ae0.0 (Index 333) (SNMP ifIndex 517) (Generation 145)

Flags: Up SNMP-Traps 0x4004000 Encapsulation: ENET2

Statistics	Packets	pps	Bytes	bps
------------	---------	-----	-------	-----

Bundle:

Input :	34243935928183	6010160	11536009310170467	16116995960
---------	----------------	---------	-------------------	-------------

Output:	71090429597976	10451659	79363169937806454	94884697104
---------	----------------	----------	-------------------	-------------

Adaptive Statistics:

Adaptive Adjusts:	0
-------------------	---

Adaptive Scans :	0
------------------	---

Adaptive Updates:	0
-------------------	---

Link:

et-0/0/0.0

Input :	11298708983442	2030928	3805108340032805	5555110248
---------	----------------	---------	------------------	------------

Output:	23308119937548	3424862	26023713920361802	30952365312
---------	----------------	---------	-------------------	-------------

et-3/0/1.0

Input :	11419377486627	1980800	3848204937492876	5200758512
---------	----------------	---------	------------------	------------

Output:	23747173576030	3493846	26511514194652619	31799446616
---------	----------------	---------	-------------------	-------------

et-10/0/0.0

Input :	11412365473613	1998432	3843844231672195	5361127200
---------	----------------	---------	------------------	------------

Output:	23736059007904	3532951	26496037962502537	32132885176
---------	----------------	---------	-------------------	-------------

Aggregate member links: 3

BFD View :

Link	Usable
------	--------

et-0/0/0.0	Yes
------------	-----

et-3/0/1.0	Yes
------------	-----

et-10/0/0.0	Yes
-------------	-----

LACP info:	Role	System priority	System identifier	Port priority	Port number	Port key
et-0/0/0.0	Actor	127	d4:04:ff:61:c7:e0	127	41	1

```

et-0/0/0.0 Partner      127 54:1e:56:54:0d:08    127 49 15
et-3/0/1.0 Actor       127 d4:04:ff:61:c7:e0    127 6 1
et-3/0/1.0 Partner     127 54:1e:56:54:0d:08    127 7 15
et-10/0/0.0 Actor      127 d4:04:ff:61:c7:e0    127 15 1
et-10/0/0.0 Partner    127 54:1e:56:54:0d:08    127 19 15

LACP Statistics:      LACP Rx   LACP Tx   Unknown Rx  Illegal Rx
et-0/0/0.0           7238124   7237616   0           0
et-3/0/1.0           7317685   7317124   0           0
et-10/0/0.0          7317430   7317147   0           0

Marker Statistics:   Marker Rx  Resp Tx   Unknown Rx  Illegal Rx
et-0/0/0.0           0          0         0           0
et-3/0/1.0           0          0         0           0
et-10/0/0.0          0          0         0           0

Protocol inet, MTU: 9178
Max nh cache: 75000, New hold nh limit: 75000, Curr nh cnt: 1, Curr new hold cnt: 0, NH drop
cnt: 0

```

Release Information

Command modified in Junos OS Release 10.2.

show interfaces flow-statistics

IN THIS SECTION

- [Syntax | 559](#)
- [Description | 559](#)
- [Options | 559](#)
- [Required Privilege Level | 560](#)
- [Output Fields | 560](#)
- [Sample Output | 563](#)
- [Release Information | 565](#)

Syntax

```
show interfaces flow-statistics <interface-name>
```

Description

Display interfaces flow statistics.

Options

Interface-name —(Optional) Display flow statistics about the specified interface. Following is a list of typical interface names. Replace *pim* with the PIM slot and *port* with the port number. For a complete list, see the *Interface Naming Conventions*.

- *at-pim/0/port*—ATM-over-ADSL or ATM-over-SHDSL interface.
- *br-pim/0/port*—Basic Rate Interface for establishing ISDN connections.
- *ce1-pim/0/port*—Channelized E1 interface.
- *ct1-pim/0/port*—Channelized T1 interface.
- *d10*—Dialer Interface for initiating ISDN and USB modem connections.
- *e1-pim/0/port*—E1 interface.
- *e3-pim/0/port*—E3 interface.
- *fe-pim/0/port*—Fast Ethernet interface.
- *ge-pim/0/port*—Gigabit Ethernet interface.
- *se-pim/0/port*—Serial interface.
- *t1-pim/0/port*—T1 (also called DS1) interface.
- *t3-pim/0/port*—T3 (also called DS3) interface.
- *wx-slot/0/0*—WAN acceleration interface, for the WXC Integrated Services Module (ISM 200).

Required Privilege Level

view

Output Fields

[Table 31 on page 560](#) lists the output fields for the `show interfaces flow-statistics` command. Output fields are listed in the approximate order in which they appear.

Table 31: show interfaces flow-statistics Output Fields

Field Name	Field Description
Traffic statistics	Number of packets and bytes transmitted and received on the physical interface.
Local statistics	Number of packets and bytes transmitted and received on the physical interface.
Transit statistics	Number of packets and bytes transiting the physical interface.
Flow input statistics	Statistics on packets received by flow module.
Flow output statistics	Statistics on packets sent by flow module.
Flow error statistics	Packet drop statistics for the flow module. For further details, see Table 32 on page 560 .

Table 32: Flow Error Statistics (Packet Drop Statistics for the Flow Module)

Error	Error Description
Screen:	
Address spoofing	The packet was dropped when the screen module detected address spoofing.

Syn-attack protection	The packet was dropped because of SYN attack protection or SYN cookie protection.
VPN:	
Authentication failed	The packet was dropped because the IPsec Encapsulating Security Payload (ESP) or Authentication Header (AH) authentication failed.
No SA for incoming SPI	The packet was dropped because the incoming IPsec packet's security parameter index (SPI) does not match any known SPI.
Security association not active	The packet was dropped because an IPsec packet was received for an inactive SA.
NAT:	
Incoming NAT errors	The source NAT rule search failed, an invalid source NAT binding was found, or the NAT allocation failed.
Multiple incoming NAT	Sometimes packets are looped through the system more than once; if source NAT is specified more than once, the packet will be dropped.
Auth:	
Multiple user authentications	Sometimes packets are looped through the system more than once. Each time a packet passes through the system, that packet must be permitted by a policy. If the packet matches more than one policy that specifies user authentication, then it will be dropped.
User authentication errors	Packet was dropped because policy requires authentication; however: <ul style="list-style-type: none"> • Only Telnet, FTP, and HTTP traffic can be authenticated. • The corresponding authentication entry could not be found, if web-auth is specified. • The maximum number of authenticated sessions per user was exceeded.
Flow:	

No one interested in self packets	<p>This counter is incremented for one of the following reasons:</p> <ul style="list-style-type: none"> • The outbound interface is a self interface, but the packet is not marked as a to-self packet and the destination address is in a source NAT pool. • No service is interested in the to-self packet • When a zone has ident-reset service enabled, the TCP RST to IDENT request for port 113 is sent back and this counter is incremented.
No minor session	<p>The packet was dropped because no minor sessions are available and a minor session was requested. Minor sessions are allocated for storing additional TCP state information.</p>
No more sessions	<p>The packet was dropped because there were no more free sessions available.</p>
No route present	<p>The packet was dropped because a valid route was not available to forward the packet.</p> <p>For new sessions, the counter is incremented for one of the following reasons:</p> <ul style="list-style-type: none"> • No valid route was found to forward the packet. • A discard or reject route was found. • The route could not be added due to lack of memory. • The reverse path forwarding check failed for an incoming multicast packet. <p>For existing sessions, the prior route was changed or deleted, or a more specific route was added. The session is rerouted, and this reroute could fail because:</p> <ul style="list-style-type: none"> • A new route could not be found; either the previous route was removed, or the route was changed to discard or reject. • Multiple packets may concurrently force rerouting to occur, and only one packet can successfully complete the rerouting process. Other packets will be dropped. • The route table was locked for updates by the Routing Engine. Packets that match a new session are retried, whereas packets that match an existing session are not.
No tunnel found	<p>The packet was dropped because a valid tunnel could not be found</p>

No session for a gate	This counter is incremented when a packet is destined for an ALG, and the ALG decides to drop this packet.
No zone or NULL zone binding	The packet was dropped because its incoming interface was not bound to any zone.
Policy denied	The error counter is incremented for one of the following reasons: <ul style="list-style-type: none"> • Source and/or destination NAT has occurred and policy says to drop the packet. • Policy specifies user authentication, which failed. • Policy was configured to deny this packet.
TCP sequence number out of window	A TCP packet with a sequence number failed the TCP sequence number check that was received.

Counters Not Currently in Use

No parent for a gate	-
Invalid zone received packet	-
No NAT gate	-

Sample Output

show interfaces flow-statistics (Gigabit Ethernet)

```

user@host> show interfaces flow-statistics ge-0/0/1.0
Logical interface ge-0/0/1.0 (Index 70) (SNMP ifIndex 49)
Flags: SNMP-Traps Encapsulation: ENET2
Input packets : 5161
Output packets: 83
Security: Zone: zone2
Allowed host-inbound traffic : bootp bfd bgp dns dvmrp igmp ldp msdp nhrp ospf pgm

```

pim rip router-discovery rsvp sap vrrp dhcp finger ftp tftp ident-reset http https ike
 netconf ping rlogin rpm rsh snmp snmp-trap ssh telnet traceroute xnm-clear-text xnm-ssl
 lsping

Flow Statistics :

Flow Input statistics :

Self packets :	0
ICMP packets :	0
VPN packets :	2564
Bytes permitted by policy :	3478
Connections established :	1

Flow Output statistics:

Multicast packets :	0
Bytes permitted by policy :	16994

Flow error statistics (Packets dropped due to):

Address spoofing:	0
Authentication failed:	0
Incoming NAT errors:	0
Invalid zone received packet:	0
Multiple user authentications:	0
Multiple incoming NAT:	0
No parent for a gate:	0
No one interested in self packets:	0
No minor session:	0
No more sessions:	0
No NAT gate:	0
No route present:	0
No SA for incoming SPI:	0
No tunnel found:	0
No session for a gate:	0
No zone or NULL zone binding	0
Policy denied:	0
Security association not active:	0
TCP sequence number out of window:	0
Syn-attack protection:	0
User authentication errors:	0

Protocol inet, MTU: 1500

Flags: None

Addresses, Flags: Is-Preferred Is-Primary

Destination: 203.0.113.1/24, Local: 203.0.113.2, Broadcast: 2.2.2.255

Release Information

Command introduced in Junos OS Release 9.2.

RELATED DOCUMENTATION

[Understanding Traffic Processing on Security Devices | 2](#)

Understanding Interfaces

show interfaces swfabx

IN THIS SECTION

- [Syntax | 565](#)
- [Description | 565](#)
- [Required Privilege Level | 566](#)
- [Output Fields | 566](#)
- [Sample Output | 566](#)
- [Release Information | 567](#)

Syntax

```
show interfaces (swfab0 | swfab1)
```

Description

Display the configured interfaces for each swfab interface. The swfab interface can contain one or more members because it is an aggregated interface.

Required Privilege Level

view

Output Fields

[Table 33 on page 566](#) lists the output fields for the `show interfaces <swfab0 | swfab1>` command. Output fields are listed in the approximate order in which they appear.

Table 33: show interfaces <swfab0 | swfab1> Output Fields

Field Name	Field Description
fabric-options	The fabric-options hierarchy is configured to be in sync with the fab interfaces.
member-interfaces	Interfaces specified under member-interfaces are single aggregate interfaces. This interface carries internode switching traffic.

Sample Output

`show interfaces swfab0`

```
user@host# show interfaces swfab0
fabric-options {
    member-interfaces {
        ge-0/0/9;
        ge-0/0/10;
    }
}
```

show interfaces swfab1

```
user@host# show interfaces swfab1
fabric-options {
    member-interfaces {
        ge-7/0/9;
        ge-7/0/10;
    }
}
```

Release Information

Command introduced in Junos OS Release 11.1.

RELATED DOCUMENTATION

| *clear interfaces statistics swfabx*

show monitor security flow

IN THIS SECTION

- [Syntax | 568](#)
- [Description | 568](#)
- [Required Privilege Level | 568](#)
- [Output Fields | 568](#)
- [Sample Output | 569](#)
- [Release Information | 570](#)

Syntax

```
show monitor security flow
```

Description

Display information about the security flow session monitoring.

Required Privilege Level

view

Output Fields

Lists the output fields for the `show monitor security flow` command. Output fields are listed in the approximate order in which they appear.

Table 34: show monitor security flow Output Fields

Field Name	Field Description
Monitor security flow session status	State of the security flow session monitoring: active or inactive.
Monitor security flow trace file	Name of the file for monitoring output.

Table 34: show monitor security flow Output Fields (Continued)

Field Name	Field Description
Monitor security flow filters	<ul style="list-style-type: none"> • conn-tag—Tag that uniquely identifies a session. The session key is expanded to include this tuple. • Destination Address—Address of the destination to be matched. • Destination Port—Name of the destination port to be matched. • Interface Name—Interface name to be matched. • Logical System Name—Logical system name to be matched. • Name—Name of the security flow filter. • Protocol—Name of the protocol to be matched. • Source Address—Address of the source to be matched. • Source Port—Name of the source port to be matched. • Status—State of the security flow filter: active or inactive.

Sample Output

show monitor security flow

```

user@host>show monitor security flow

Monitor security flow session status: Active
Monitor security flow trace file: flow
Monitor security flow filters:
  Name: server-sql
    Status: Active
    source: 10.2.2.1 (port *), destination: 10.20.30.40 (port 1433)
    protocol: TCP
    conn-tag: 0
  Name: internet-access
    Status: Active

```

```
source: * (port *), destination: * (port 80)
protocol: TCP
conn-tag: 0
```

Release Information

Command introduced in Junos OS Release 12.1X46-D10. This topic was updated to include the flow session conn-tag filter in Junos OS Release 15.1X49-D70.

RELATED DOCUMENTATION

[Monitoring Security Flow Sessions Overview | 186](#)

[monitor security flow filter | 491](#)

[monitor security flow start | 494](#)

[clear monitor security flow filter | 432](#)

show resource-manager cpu

IN THIS SECTION

- [Syntax | 571](#)
- [Description | 571](#)
- [Required Privilege Level | 571](#)
- [Sample Output | 571](#)
- [Release Information | 572](#)

Syntax

```
show resource-manager cpu
```

Description

This command displays the CPU utilization.

Required Privilege Level

view

Sample Output

```
show resource-manager cpu
```

```
user@host> show resource-manager cpu
fpc 0 pic 0

CPU Threshold exceeded :0

CPU threshold Clear :0

Drop flows :0

Throttled Sessions :0

Packets Dropped :0

Alarm Sent :0

Messages logged :0
```

Release Information

Command introduced in Junos OS Release 20.4R1.

RELATED DOCUMENTATION

[Understanding Traffic Processing on Security Devices | 2](#)

show resource-manager memory

IN THIS SECTION

- [Syntax | 572](#)
- [Description | 572](#)
- [Required Privilege Level | 573](#)
- [Sample Output | 573](#)
- [Release Information | 573](#)

Syntax

```
show resource-manager memory
```

Description

Display the CPU and memory utilization.

Required Privilege Level

view

Sample Output

show resource-manager memory

```
user@host> show resource-manager memory
fpc 0 pic 0

Session Low Watermark Hit :0

Session High Watermark Hit :0

Memory Threshold exceeded :15

Memory threshold Clear :14

Early Session Aged Out :0

Drop flows :0

Fail Open :0

Fail Close :167814

Alarm Sent :15

Messages logged :29
```

Release Information

Command introduced in Junos OS Release 20.4R1.

RELATED DOCUMENTATION

[Understanding Traffic Processing on Security Devices | 2](#)

show resource-manager

IN THIS SECTION

- [Syntax | 574](#)
- [Description | 574](#)
- [Required Privilege Level | 574](#)
- [Sample Output | 575](#)
- [Release Information | 575](#)

Syntax

```
show resource-manager
```

Description

Display the CPU and memory utilization.

Required Privilege Level

view

Sample Output

show resource-manager

```
user@host> show resource-manager
FPC 0 PIC 0

Services Memory: 0 %

Packet Memory: 0 %

Session created: 631829

THREAD 0

Last Minute CPU Average %: 0
```

Release Information

Command introduced in Junos OS Release 20.4R1.

RELATED DOCUMENTATION

[Understanding Traffic Processing on Security Devices | 2](#)

show security flow cp-session

IN THIS SECTION

- [Syntax | 576](#)
- [Description | 576](#)
- [Options | 576](#)

- Required Privilege Level | 577
- Output Fields | 577
- Sample Output | 578
- Sample Output | 579
- Release Information | 580

Syntax

```
show security flow cp-session [<filter>] [summary | terse]
<node ( node-id | all | local | primary)>
```

Description

Display central point session-related flow information. This command is supported on the SRX5800, SRX5600, and SRX5400 devices.

Options

- `conn-tag`—Session connection tag (0..4294967295)
- `destination-port`—Destination port (1..65535)
- `destination-prefix`—Destination prefix
- `family`—Display session by family.
- `logical-system`—Logical-system name
- `node`—(Optional) For chassis cluster configurations, display security flow cp-session information on a specific node (device) in the cluster.
 - `node-id` —Identification number of the node. It can be 0 or 1.
 - `all` —Display information about all nodes.

- `local` —Display information about the local node.
- `primary`—Display information about the primary node.
- `protocol`—IP protocol number
- `root-logical-system`—Root logical-system (default)
- `source-port`—Source port (1..65535)
- `source-prefix`—Source IP prefix or address
- `summary | terse`—Display the specified level of output.

Required Privilege Level

view

Output Fields

[Table 35 on page 577](#) lists the output fields for the `show security flow cp-session` command. Output fields are listed in the approximate order in which they appear.

Table 35: show security flow cp-session Output Fields

Field Name	Field Description
Valid gates	Number of valid central point sessions.
Pending gates	Number of pending central point sessions.
Invalidated gates	Number of invalid central point sessions.
Gates in other states	Number of central point sessions in other states.
Total gates	Number of central point sessions in total.

Table 35: show security flow cp-session Output Fields (Continued)

Field Name	Field Description
Maximum sessions	Number of maximum central point sessions.
Maximum inet6 sessions	Number of maximum inet6 central point sessions.
Session ID	Number that identifies the session. Use this ID to get more information about the session.
Conn Tag	A 32-bit connection tag that uniquely identifies the GPRS tunneling protocol, user plane (GTP-U) and the Stream Control Transmission Protocol (STCP) sessions. The connection tag for GTP-U is the tunnel endpoint identifier (TEID) and for SCTP is the vTag. The connection ID remains 0 if the connection tag is not used by the sessions.
SPU	Services Processing Unit.
In	Incoming flow (source and destination IP addresses).
Out	Reverse flow (source and destination IP addresses).

Sample Output

show security flow cp-session

```

root> show security flow cp-session
DCP Flow Sessions on FPC0 PIC0:
Total sessions: 0

DCP Flow Sessions on FPC0 PIC1:

Session ID: 10320276, SPU: 1, Valid
  In: 203.0.113.1/1000 --> o 203.0.113.2/2000;udp, Conn Tag: 0x0,

```

```
Out: 0.0.0.0/0 --> 0.0.0.0/0;0, Conn Tag: 0x0,  
Total sessions: 1
```

Sample Output

show security flow cp-session summary

```
root> show security flow cp-session summary  
DCP Flow Sessions on FPC10 PIC0:  
  
Valid sessions: 0  
Pending sessions: 0  
Invalidated sessions: 0  
Sessions in other states: 0  
Total sessions: 0  
  
DCP Flow Sessions on FPC10 PIC1:  
  
Valid sessions: 2  
Pending sessions: 0  
Invalidated sessions: 0  
Sessions in other states: 0  
Total sessions: 2  
Maximum sessions: 7549747  
Maximum inet6 sessions: 7549747  
  
DCP Flow Sessions on FPC10 PIC2:  
  
Valid sessions: 2  
Pending sessions: 0  
Invalidated sessions: 0  
Sessions in other states: 0  
Total sessions: 2  
Maximum sessions: 7549747  
Maximum inet6 sessions: 7549747  
  
DCP Flow Sessions on FPC10 PIC3:  
  
Valid sessions: 1
```

```
Pending sessions: 0
Invalidated sessions: 0
Sessions in other states: 0
Total sessions: 1
Maximum sessions: 7549747
Maximum inet6 sessions: 7549747
```

show security flow cp-session terse

```
root> show security flow cp-session terse
DCP Flow Sessions on FPC0 PIC1:

Session ID: 10000038, SPU: 1, Valid
  In: 203.0.113.6/1 --> 198.51.100.13/1;pim, Conn Tag: 0x0,
  Out: 198.51.100.13/1 --> 203.0.113.6/1;pim, Conn Tag: 0x0,

Total sessions: 1
```

Release Information

Command introduced in Junos OS Release 10.2. Support.

RELATED DOCUMENTATION

[Understanding Traffic Processing on Security Devices | 2](#)

show security flow cp-session destination-port

IN THIS SECTION

- [Syntax | 581](#)
- [Description | 581](#)

- Options | 581
- Required Privilege Level | 581
- Output Fields | 582
- Sample Output | 582
- Release Information | 584

Syntax

```
show security flow cp-session destination-port destination-port-number [summary | terse]
```

Description

Display central point session-related flow information for the specified destination port.

Options

- *destination-port-number*—Number of the destination port for which to display central point session information.
Range: 1 through 65,535
- summary | terse—Display the specified level of output.

Required Privilege Level

view

Output Fields

Table 36 on page 582 lists the output fields for the `show security flow cp-session destination-port` command. Output fields are listed in the approximate order in which they appear.

Table 36: show security flow cp-session destination-port Output Fields

Field Name	Field Description
Valid gates	Number of valid central point sessions.
Pending gates	Number of pending central point sessions.
Invalidated gates	Number of invalid central point sessions.
Gates in other states	Number of central point sessions in other states.
Total gates	Number of central point sessions in total.
Session ID	Number that identifies the session. Use this ID to get more information about the session.
SPU	Services Processing Unit.
In	Incoming flow (source and destination IP addresses).
Out	Reverse flow (source and destination IP addresses).

Sample Output

show security flow cp-session destination-port summary

```
root> show security flow cp-session destination-port 21 summary
DCP Flow Sessions on FPC10 PIC0:
```

```
Valid sessions: 0
Pending sessions: 0
Invalidated sessions: 0
Sessions in other states: 0
Total sessions: 0
```

DCP Flow Sessions on FPC10 PIC1:

```
Valid sessions: 0
Pending sessions: 0
Invalidated sessions: 0
Sessions in other states: 0
Total sessions: 0
```

DCP Flow Sessions on FPC10 PIC2:

```
Valid sessions: 1
Pending sessions: 0
Invalidated sessions: 0
Sessions in other states: 0
Total sessions: 1
```

DCP Flow Sessions on FPC10 PIC3:

```
Valid sessions: 0
Pending sessions: 0
Invalidated sessions: 0
Sessions in other states: 0
Total sessions: 0
```

show security flow cp-session destination-port terse

```
root> show security flow cp-session destination-port 21 terse
DCP Flow Sessions on FPC10 PIC0:
Total sessions: 0

DCP Flow Sessions on FPC10 PIC1:

Session ID: 410003298, SPU: 41, Valid
  In: 203.0.113.10/26182 --> 198.51.100.1/21;tcp,
```

```
Out: 198.51.100.1/21 --> 203.0.113.10/26182;tcp,  
Total sessions: 1
```

```
DCP Flow Sessions on FPC10 PIC2:  
Total sessions: 0
```

```
DCP Flow Sessions on FPC10 PIC3:  
Total sessions: 0
```

Release Information

Command introduced in Junos OS Release 10.2. This command is supported.

RELATED DOCUMENTATION

[show security flow cp-session | 575](#)

[show security flow cp-session destination-prefix | 584](#)

show security flow cp-session destination-prefix

IN THIS SECTION

- [Syntax | 585](#)
- [Description | 585](#)
- [Options | 585](#)
- [Required Privilege Level | 585](#)
- [Output Fields | 585](#)
- [Sample Output | 586](#)
- [Release Information | 588](#)

Syntax

```
show security flow cp-session destination-prefix destination-IP-prefix [summary | terse]
```

Description

Display central point session-related flow information for the specified destination prefix.

Options

- *destination-IP-prefix*—Destination IP prefix or address for which to display central point session information.
Range: 1 through 65,535.
- `summary | terse`—Display the specified level of output.

Required Privilege Level

view

Output Fields

[Table 37 on page 585](#) lists the output fields for the `show security flow cp-session destination-prefix` command. Output fields are listed in the approximate order in which they appear.

Table 37: show security flow cp-session destination-prefix Output Fields

Field Name	Field Description
Valid gates	Number of valid central point sessions.

Table 37: show security flow cp-session destination-prefix Output Fields (Continued)

Field Name	Field Description
Pending gates	Number of pending central point sessions.
Invalidated gates	Number of invalid central point sessions.
Gates in other states	Number of central point sessions in other states.
Total gates	Number of central point sessions in total.
Session ID	Number that identifies the session. Use this ID to get more information about the session.
SPU	Services Processing Unit.
In	Incoming flow (source and destination IP addresses).
Out	Reverse flow (source and destination IP addresses).

Sample Output

show security flow cp-session destination-prefix summary

```

root> show security flow cp-session destination-prefix 60/8 summary
DCP Flow Sessions on FPC10 PIC0:

Valid sessions: 0
Pending sessions: 0
Invalidated sessions: 0
Sessions in other states: 0
Total sessions: 0

DCP Flow Sessions on FPC10 PIC1:

```

```
Valid sessions: 0
Pending sessions: 0
Invalidated sessions: 0
Sessions in other states: 0
Total sessions: 0
```

DCP Flow Sessions on FPC10 PIC2:

```
Valid sessions: 1
Pending sessions: 0
Invalidated sessions: 0
Sessions in other states: 0
Total sessions: 1
```

DCP Flow Sessions on FPC10 PIC3:

```
Valid sessions: 0
Pending sessions: 0
Invalidated sessions: 0
Sessions in other states: 0
Total sessions: 0
```

show security flow cp-session destination-prefix terse

```
root> show security flow cp-session destination-prefix 60/8 terse
```

DCP Flow Sessions on FPC10 PIC0:

```
Total sessions: 0
```

DCP Flow Sessions on FPC10 PIC1:

```
Total sessions: 0
```

DCP Flow Sessions on FPC10 PIC2:

```
Session ID: 420002660, SPU: 42, Valid
```

```
In: 203.0.113.10/26183 --> 192.0.2.1/21;tcp,
```

```
Out:192.0.2.1/21 --> 203.0.113.10/26183;tcp,
```

```
Total sessions: 1
```

```
DCP Flow Sessions on FPC10 PIC3:
```

```
Total sessions: 0
```

Release Information

Command introduced in Junos OS Release 10.2. This command is supported.

RELATED DOCUMENTATION

[show security flow cp-session | 575](#)

[show security flow cp-session destination-port | 580](#)

show security flow cp-session family

IN THIS SECTION

- [Syntax | 588](#)
- [Description | 589](#)
- [Options | 589](#)
- [Required Privilege Level | 589](#)
- [Output Fields | 589](#)
- [Sample Output | 590](#)
- [Release Information | 591](#)

Syntax

```
show security flow cp-session family family [summary | terse]
```

Description

Display central point session-related flow information for the specified family.

Options

- *family*—Display session by family.
- *inet*—Display IPv4 sessions.
- *inet6*—Display IPv6 and IPv6-NATPT sessions.
- *summary | terse*—Display the specified level of output.

Required Privilege Level

view

Output Fields

[Table 38 on page 589](#) lists the output fields for the `show security flow cp-session family` command. Output fields are listed in the approximate order in which they appear.

Table 38: show security flow cp-session family Output Fields

Field Name	Field Description
Valid gates	Number of valid central point sessions.
Pending gates	Number of pending central point sessions.
Invalidated gates	Number of invalid central point sessions.
Gates in other states	Number of central point sessions in other states.

Table 38: show security flow cp-session family Output Fields (Continued)

Field Name	Field Description
Total gates	Number of central point sessions in total.
Session ID	Number that identifies the session. Use this ID to get more information about the session.
SPU	Services Processing Unit.
In	Incoming flow (source and destination IP addresses).
Out	Reverse flow (source and destination IP addresses).

Sample Output

show security flow cp-session family summary

```

root> show security flow cp-session family inet summary
DCP Flow Sessions on FPC10 PIC0:

Valid sessions: 0
Pending sessions: 0
Invalidated sessions: 0
Sessions in other states: 0
Total sessions: 0

DCP Flow Sessions on FPC10 PIC1:

Valid sessions: 0
Pending sessions: 0
Invalidated sessions: 0
Sessions in other states: 0
Total sessions: 0

```

```
DCP Flow Sessions on FPC10 PIC2:
```

```
Valid sessions: 1  
Pending sessions: 0  
Invalidated sessions: 0  
Sessions in other states: 0  
Total sessions: 1
```

```
DCP Flow Sessions on FPC10 PIC3:
```

```
Valid sessions: 0  
Pending sessions: 0  
Invalidated sessions: 0  
Sessions in other states: 0  
Total sessions: 0
```

show security flow cp-session family terse

```
root> show security flow cp-session family inet terse
```

```
DCP Flow Sessions on FPC10 PIC0:
```

```
Total sessions: 0
```

```
DCP Flow Sessions on FPC10 PIC1:
```

```
Total sessions: 0
```

```
DCP Flow Sessions on FPC10 PIC2:
```

```
Session ID: 420002660, SPU: 42, Valid
```

```
In: 198.51.100.1/26183 --> 203.0.113.2/21;tcp,
```

```
Out: 203.0.113.2/21 --> 198.51.100.1/26183;tcp,
```

```
Total sessions: 1
```

```
DCP Flow Sessions on FPC10 PIC3:
```

```
Total sessions: 0
```

Release Information

Command introduced in Junos OS Release 10.2. This command is supported.

RELATED DOCUMENTATION

| [show security flow cp-session](#) | 575

show security flow cp-session protocol

IN THIS SECTION

- [Syntax](#) | 592
- [Description](#) | 592
- [Options](#) | 592
- [Required Privilege Level](#) | 593
- [Output Fields](#) | 593
- [Sample Output](#) | 594
- [Release Information](#) | 595

Syntax

```
show security flow cp-session protocol protocol-name [summary | terse]
```

Description

Display central point session-related flow information for the specified protocol. This command is supported on the SRX1500, SRX5400, SRX5600, and SRX5800 devices and vSRX Virtual Firewall.

Options

- *protocol-name* – Protocol to use as a central point session filter. Information about the central point session that uses this protocol is displayed.

Possible protocols are:

- ah—IP Security Authentication Header
- egp—Exterior gateway protocol
- esp—IPsec Encapsulating Security Payload
- gre—Generic routing encapsulation
- icmp—Internet Control Message Protocol
- icmp6—Internet Control Message Protocol
- igmp—Internet Group Management Protocol
- ipip—IP over IP
- ospf—Open Shortest Path First
- pim—Protocol Independent Multicast
- rsvp—Resource Reservation Protocol
- sctp—Stream Control Transmission Protocol
- tcp—Transmission Control Protocol
- udp—User Datagram Protocol
- summary | terse—Display the specified level of output.

Required Privilege Level

view

Output Fields

[Table 39 on page 594](#) lists the output fields for the `show security flow cp-session protocol` command. Output fields are listed in the approximate order in which they appear.

Table 39: show security flow cp-session protocol Output Fields

Field Name	Field Description
Valid gates	Number of valid central point sessions.
Pending gates	Number of pending central point sessions.
Invalidated gates	Number of invalid central point sessions.
Gates in other states	Number of central point sessions in other states.
Total gates	Number of central point sessions in total.
Session ID	Number that identifies the session. Use this ID to get more information about the session.
SPU	Services Processing Unit.
In	Incoming flow (source and destination IP addresses).
Out	Reverse flow (source and destination IP addresses).

Sample Output

show security flow cp-session protocol summary

```

root> show security flow cp-session protocol tcp summary
DCP Flow Sessions on FPC10 PIC0:

Valid sessions: 0
Pending sessions: 0
Invalidated sessions: 0
Sessions in other states: 0
Total sessions: 0

```

DCP Flow Sessions on FPC10 PIC1:

Valid sessions: 0
Pending sessions: 0
Invalidated sessions: 0
Sessions in other states: 0
Total sessions: 0

DCP Flow Sessions on FPC10 PIC2:

Valid sessions: 0
Pending sessions: 0
Invalidated sessions: 0
Sessions in other states: 0
Total sessions: 0

DCP Flow Sessions on FPC10 PIC3:

Valid sessions: 1
Pending sessions: 0
Invalidated sessions: 0
Sessions in other states: 0
Total sessions: 1

show security flow cp-session protocol terse

```
root> show security flow cp-session protocol tcp terse
Session ID: 160000015, SPU: 17, Valid
  In: 203.0.113.9/32838 --> 198.51.100.26/21;tcp,
  Out: 198.51.100.26/21 --> 203.0.113.2/32838;tcp,
Total sessions: 1
```

Release Information

Command introduced in Junos OS Release 10.2.

RELATED DOCUMENTATION

| [show security flow cp-session](#) | 575

show security flow cp-session source-port

IN THIS SECTION

- [Syntax](#) | 596
- [Description](#) | 596
- [Options](#) | 597
- [Required Privilege Level](#) | 597
- [Output Fields](#) | 597
- [Sample Output](#) | 598
- [Release Information](#) | 599

Syntax

```
show security flow cp-session source-port source-port-number [summary | terse]
```

Description

Display central point session-related flow information for the specified source-port. This command is supported on the SRX1500, SRX5400, SRX5600, and SRX5800 devices and vSRX Virtual Firewall.

Options

source-port-number Number of the source port about which to display central point session information.

Range: 1 through 65,535

summary | terse Display the specified level of output.

Required Privilege Level

view

Output Fields

[Table 40 on page 597](#) lists the output fields for the `show security flow cp-session source-port` command. Output fields are listed in the approximate order in which they appear.

Table 40: show security flow cp-session source-port Output Fields

Field Name	Field Description
Valid gates	Number of valid central point sessions.
Pending gates	Number of pending central point sessions.
Invalidated gates	Number of invalid central point sessions.
Gates in other states	Number of central point sessions in other states.
Total gates	Number of central point sessions in total.
Session ID	Number that identifies the session. Use this ID to get more information about the session.

Table 40: show security flow cp-session source-port Output Fields (Continued)

Field Name	Field Description
SPU	Services Processing Unit.
In	Incoming flow (source and destination IP addresses).
Out	Reverse flow (source and destination IP addresses).

Sample Output

show security flow cp-session source-port summary

```

root> show security flow cp-session source-port 7000 summary
DCP Flow Sessions on FPC10 PIC0:

Valid sessions: 0
Pending sessions: 0
Invalidated sessions: 0
Sessions in other states: 0
Total sessions: 0

DCP Flow Sessions on FPC10 PIC1:

Valid sessions: 0
Pending sessions: 0
Invalidated sessions: 0
Sessions in other states: 0
Total sessions: 0

DCP Flow Sessions on FPC10 PIC2:

Valid sessions: 1
Pending sessions: 0
Invalidated sessions: 0
Sessions in other states: 0

```

```
Total sessions: 1
```

```
DCP Flow Sessions on FPC10 PIC3:
```

```
Valid sessions: 0
```

```
Pending sessions: 0
```

```
Invalidated sessions: 0
```

```
Sessions in other states: 0
```

```
Total sessions: 0
```

show security flow cp-session source-port terse

```
root> show security flow cp-session source-port 7000 terse
```

```
DCP Flow Sessions on FPC10 PIC0:
```

```
Total sessions: 0
```

```
DCP Flow Sessions on FPC10 PIC1:
```

```
Total sessions: 0
```

```
DCP Flow Sessions on FPC10 PIC2:
```

```
Session ID: 420002661, SPU: 42, Valid
```

```
In: 203.0.113.64/7000 --> 192.0.2.9/8000;udp,
```

```
Out: 192.0.2.9/8000 --> 203.0.113.64/7000;udp,
```

```
Total sessions: 1
```

```
DCP Flow Sessions on FPC10 PIC3:
```

```
Total sessions: 0
```

Release Information

Command introduced in Junos OS Release 10.2.

RELATED DOCUMENTATION

[show security flow cp-session | 575](#)

[show security flow cp-session source-prefix | 600](#)

show security flow cp-session source-prefix

IN THIS SECTION

- [Syntax | 600](#)
- [Description | 600](#)
- [Options | 600](#)
- [Required Privilege Level | 601](#)
- [Output Fields | 601](#)
- [Sample Output | 602](#)
- [Release Information | 603](#)

Syntax

```
show security flow cp-session source-prefix source-IP-prefix [summary | terse]
```

Description

Display central point session related flow information for the specified source-prefix. This is supported on the SRX1500, SRX5400, SRX5600, and SRX5800 devices and vSRX Virtual Firewall.

Options

- *source-IP-prefix*—Source IP prefix or address for which to display central point session information.
- `summary | terse`—Display the specified level of output.

Required Privilege Level

view

Output Fields

[Table 41 on page 601](#) lists the output fields for the `show security flow cp-session source-prefix` command. Output fields are listed in the approximate order in which they appear.

Table 41: show security flow cp-session source-prefix Output Fields

Field Name	Field Description
Valid gates	Number of valid central point sessions.
Pending gates	Number of pending central point sessions.
Invalidated gates	Number of invalid central point sessions.
Gates in other states	Number of central point sessions in other states.
Total gates	Number of central point sessions in total.
Session ID	Number that identifies the session. Use this ID to get more information about the session.
SPU	Services Processing Unit.
In	Incoming flow (source and destination IP addresses).
Out	Reverse flow (source and destination IP addresses).

Sample Output

show security flow cp-session source-prefix summary

```
root> show security flow cp-session source-prefix 203/8 summary
```

```
DCP Flow Sessions on FPC10 PIC0:
```

```
Valid sessions: 0
```

```
Pending sessions: 0
```

```
Invalidated sessions: 0
```

```
Sessions in other states: 0
```

```
Total sessions on FPC10 PIC1:
```

```
: 0
```

```
DCP Flow SessiValid sessions: 0
```

```
Pending sessions: 0
```

```
Invalidated sessions: 0
```

```
Sessions in other states: 0
```

```
Total sessions: 0
```

```
DCP Flow Sessions on FPC10 PIC2:
```

```
Valid sessions: 1
```

```
Pending sessions: 0
```

```
Invalidated sessions: 0
```

```
Sessions in other states: 0
```

```
Total sessions: 1
```

```
DCP Flow Sessions on FPC10 PIC3:
```

```
Valid sessions: 0
```

```
Pending sessions: 0
```

```
Invalidated sessions: 0
```

```
Sessions in other states: 0
```

```
Total sessions: 0
```

show security flow cp-session source-prefix terse

```
root> show security flow cp-session source-prefix 203/8 terse
DCP Flow Sessions on FPC10 PIC0:
Total sessions: 0

DCP Flow Sessions on FPC10 PIC1:
Total sessions: 0

DCP Flow Sessions on FPC10 PIC2:

Session ID: 420002663, SPU: 42, Valid
  In: 203.0.113.10/7000 --> 198.51.100.2/8000;udp,
  Out: 198.51.100.2/8000 --> 203.0.113.10/7000;udp,
Total sessions: 1

DCP Flow Sessions on FPC10 PIC3:
Total sessions: 0
```

Release Information

Command introduced in Junos OS Release 10.2.

RELATED DOCUMENTATION

[show security flow cp-session | 575](#)

[show security flow cp-session source-port | 596](#)

show security flow gate

IN THIS SECTION

● [Syntax | 604](#)

- [Description | 604](#)
- [Options | 604](#)
- [Required Privilege Level | 605](#)
- [Output Fields | 605](#)
- [Sample Output | 606](#)
- [Release Information | 609](#)

Syntax

```
show security flow gate  
[<filter>] [brief | summary]
```

Description

This command displays information about temporary openings known as pinholes or gates in the security firewall.

Pinholes are used by applications that commonly have both control and data sessions and must create openings in the firewall for the data sessions based on information from the parent sessions.

Options

- `destination-port`—Destination port
- `destination-prefix`—Destination IP prefix or address
- `protocol`—IP protocol number
- `source-port`—Source port
- `source-prefix`—Source IP prefix or address
- `brief | summary`—Display the specified level of output.

Required Privilege Level

view

Output Fields

[Table 42 on page 605](#) lists the output fields for the `show security flow gate` command. Output fields are listed in the approximate order in which they appear.

Table 42: show security flow gate Output Fields

Field Name	Field Description
Hole	Range of flows permitted by the pinhole.
Translated	Tuples used to create the session if it matches the pinhole. <ul style="list-style-type: none"> • Source address and port • Destination address and port
Protocol	Application protocol, such as UDP or TCP.
Application	Name of the application.
Age	Idle timeout for the pinhole.
Flags	Internal debug flags for the pinhole.
Zone	Incoming zone.
Reference count	Number of resource manager references to the pinhole.
Resource	Resource manager information about the pinhole.

Table 42: show security flow gate Output Fields (Continued)

Field Name	Field Description
Valid gates	Number of valid gates.
Pending gates	Number of pending gates.
Invalidated gates	Number of invalid gates.
Gates in other states	Number of gates in other states.
Total gates	Number of gates in total.
Maximum gates	Number of maximum gates

Sample Output

show security flow gate

```

user@host> show security flow gate
Hole: 0.0.0.0-0.0.0.0/0-0->40.1.1.198.51.100.252/64515-64515
Translated: 0.0.0.0/0->10.0.31.161/25415
Protocol: udp
Application: none/0
Age: 101 seconds
Flags: 0xe001
Zone: untrust
Reference count: 1
Resource: 5-1024-8185
Hole: 0.0.0.0-0.0.0.0/0-198.51.100.252/1046-1046
Translated: 198.51.100.252/36039-> 203.0.113.1/5060
Protocol: udp
Application: junos-sip/63
Age: 65535 seconds

```

```

Flags: 0xe200
Zone: untrust
Reference count: 1
Resource: 5-1024-8189
Hole: 0.0.0.0-0.0.0.0/0-0->198.51.100.252-198.51.100.252/24101-24101
Translated: 0.0.0.0/0-> 198.51.100.252/24101
Protocol: udp
Application: none/0
Age: 93 seconds
Flags: 0xe001
Zone: trust
Reference count: 1
Resource: 5-1024-8188
Hole: 0.0.0.0-0.0.0.0/0-0->40.1.1.5-198.51.100.252/24100-24100
Translated: 0.0.0.0/0->198.51.100.252/24100
Protocol: udp
Application: none/0
Age: 93 seconds
Flags: 0xe001
Zone: trust
Reference count: 1
Resource: 5-1024-8191
Hole: 0.0.0.0-0.0.0.0/0-0->198.51.100.252-198.51.100.252/5060-5060
Translated: 0.0.0.0/0->198.51.100.252/5060
Protocol: udp
Application: junos-sip/63
Age: 65535 seconds
Flags: 0xe200
Zone: trust
Reference count: 1
Resource: 5-1024-8190

```

show security flow gate brief

```

root> show security flow gate brief
Flow Gates on FPC4 PIC1:

Hole: 192.0.2.1-192.0.2.1/0->192.0.2.100-192.0.2.100/38143-38143
  Translated: 192.0.2.1->192.0.2.100/38143
  Protocol: tcp
  Application: FTP ALG/79

```

```
Age: 65532 seconds
Flags: 0x0080
Zone: trust
Reference count: 1
Resource: 1-24576-86016
```

```
Valid gates: 1
Pending gates: 0
Invalidated gates: 0
Gates in other states: 0
Total gates: 1
```

```
Flow Gates on FPC5 PIC0:
```

```
Valid gates: 0
Pending gates: 0
Invalidated gates: 0
Gates in other states: 0
Total gates: 0
```

```
Flow Gates on FPC5 PIC1:
```

```
Valid gates: 0
Pending gates: 0
Invalidated gates: 0
Gates in other states: 0
Total gates: 0
```

show security flow gate summary

```
root> show security flow gate summary
```

```
Flow Gates on FPC4 PIC1:
```

```
Valid gates: 1
Pending gates: 0
Invalidated gates: 0
Gates in other states: 0
Total gates: 1
Maximum gates: 131072
```

```
Flow Gates on FPC5 PIC0:
```



```
Valid gates: 0
Pending gates: 0
Invalidated gates: 0
Gates in other states: 0
Total gates: 0
Maximum gates: 131072
```

Flow Gates on FPC5 PIC1:

```
Valid gates: 0
Pending gates: 0
Invalidated gates: 0
Gates in other states: 0
Total gates: 0
Maximum gates: 131072
```

Release Information

Command introduced in Junos OS Release 8.5.

Filter and display options added in Junos OS Release 10.2.

RELATED DOCUMENTATION

[show security flow gate brief node | 622](#)

[show security flow gate destination-port | 630](#)

[show security flow gate destination-prefix | 635](#)

[show security flow gate protocol | 640](#)

[show security flow gate summary node | 645](#)

show security flow ip-action

IN THIS SECTION

- Syntax | 610
- Description | 610
- Options | 610
- Required Privilege Level | 612
- Output Fields | 612
- Sample Output | 613
- Release Information | 621

Syntax

```
show security flow ip-action [ <filter> ] [ summary family (inet | inet6) ]
```

Description

Display the current IP-action settings, based on filtered options, for IP sessions running on the device.

Options

- *filter*—Filter the display based on the specified criteria.

The following filters display those sessions that match the criteria specified by the filter. Refer to the sample output for filtered output examples.

all | [*filter*]
—All active sessions on the device.

destination-port *destination-port*—Destination port number of the traffic. Range is 1 through 65,535.

destination-prefix *destination-prefix*—Destination IP prefix or address.

family (inet | inet6) [*filter*]—IPv4 traffic or IPv6-NATPT traffic and filtered options.

logical-system *logical-system-name* | all [*filter*]—Specified logical system or all logical systems.

protocol *protocol-name* / *protocol-number* [*filter*]—Protocol name or number and filtered options.

- ah or 51
- egp or 8
- esp or 50
- gre or 47
- icmp or 1
- icmp6 or 58
- ipip or 4
- ospf or 89
- pim or 103
- rsvp or 46
- sctp or 132
- tcp or 6
- udp or 17

root-logical-system [*filter*]—Default logical system information and filtered options.

source-port *source-port*—Source port number of the traffic. Range is 1 through 65,535.

source-prefix *source-prefix*—Source IP prefix or address of the traffic.

- summary —Summary information about IP-action entries.

family—Display summary of IP-action entries by family. This option is used to filter the output.

- inet—Display summary of IPv4 entries.
- inet6—Display summary of IPv6 entries.

Required Privilege Level

view

Output Fields

Table 43 on page 612 lists the output fields for the `show security flow ip-action` command. Output fields are listed in the approximate order in which they appear.

Table 43: show security flow ip-action Output Fields

Field Name	Field Description
Src-Addr	Source address of outbound IP traffic.
Src-Port	Source port number of outbound IP traffic.
Dst-Addr	Destination address of inbound IP traffic.
Dst-Port/Proto	Destination port number and protocol type of inbound IP traffic.
Timeout (sec)	Configured timeouts and time remaining for an IP session.
Zone	Security zone associated with an IP session.
Action	Configured action type, for example, block, close, and notify.
State	The active mode and passive mode describe the states of the ip-action entry.
IPv4 action count	The total number of IPv4 entries.
IPv6 action count	The total number of IPv6 entries.

Sample Output

show security flow ip-action

```
user@host> show security flow ip-action
```

```
Src-Addr      Src-Port Dst-Addr      Dst-Port/Proto Timeout(sec) Zone      Action
State
  203.0.113.1  *      203.0.113.4  21/tcp        293/300      *
close      Passive
```

```
IPv4 action count: 1 on FPC0.PIC1
```

```
Src-Addr      Src-Port Dst-Addr      Dst-Port/Proto Timeout(sec) Zone      Action
State
203.0.113.1  *      203.0.113.4  21/tcp        293/300      *      close
Passive
```

```
IPv4 action count: 1 on FPC0.PIC2
```

```
Src-Addr      Src-Port Dst-Addr      Dst-Port/Proto Timeout(sec) Zone      Action
State
203.0.113.1  *      203.0.113.4  21/tcp        293/300      *      close
Passive
```

```
IPv4 action count: 1 on FPC0.PIC3
```

```
Src-Addr      Src-Port Dst-Addr      Dst-Port/Proto Timeout(sec) Zone      Action
State
203.0.113.1  *      203.0.113.4  21/tcp        293/300      *      close
Passive
```

```
IPv4 action count: 1 on FPC1.PIC0
```

```
Src-Addr      Src-Port Dst-Addr      Dst-Port/Proto Timeout(sec) Zone      Action
State
203.0.113.1  *      203.0.113.4  21/tcp        293/300      *      close
Passive
```

```
IPv4 action count: 1 on FPC1.PIC1
```

```
Src-Addr      Src-Port Dst-Addr      Dst-Port/Proto Timeout(sec) Zone      Action
State
203.0.113.1  *      203.0.113.4  21/tcp        292/300      *      close
Passive
```

```
IPv4 action count: 1 on FPC1.PIC2
```

```

Src-Addr      Src-Port Dst-Addr      Dst-Port/Proto Timeout(sec) Zone      Action
State
203.0.113.1   *       203.0.113.4   21/tcp        292/300      *       close
Active
IPv4 action count: 1 on FPC1.PIC3
IPv4 action count: Active mode 1 on all PICs
IPv6 action count: 0 on FPC0.PIC1
IPv6 action count: 0 on FPC0.PIC2
IPv6 action count: 0 on FPC0.PIC3
IPv6 action count: 0 on FPC1.PIC0
IPv6 action count: 0 on FPC1.PIC1
IPv6 action count: 0 on FPC1.PIC2
IPv6 action count: 0 on FPC1.PIC3
IPv6 action count: Active mode 0 on all PICs

```

show security flow ip-action destination-port

```
user@host> show security flow ip-action destination-port 21
```

```

Src-Addr      Src-Port Dst-Addr      Dst-Port/Proto Timeout(sec) Zone      Action
State
203.0.113.1   *       203.0.113.4   21/tcp        274/300      *       close
Passive
IPv4 action count: 1 on FPC0.PIC1

Src-Addr      Src-Port Dst-Addr      Dst-Port/Proto Timeout(sec) Zone      Action
State
203.0.113.1   *       203.0.113.4   21/tcp        274/300      *       close
Passive
IPv4 action count: 1 on FPC0.PIC2

Src-Addr      Src-Port Dst-Addr      Dst-Port/Proto Timeout(sec) Zone      Action
State
203.0.113.1   *       203.0.113.4   21/tcp        274/300      *       close
Passive
IPv4 action count: 1 on FPC0.PIC3

Src-Addr      Src-Port Dst-Addr      Dst-Port/Proto Timeout(sec) Zone      Action
State
203.0.113.1   *       203.0.113.4   21/tcp        274/300      *       close
Passive

```

IPv4 action count: 1 on FPC1.PIC0

Src-Addr	Src-Port	Dst-Addr	Dst-Port/Proto	Timeout(sec)	Zone	Action
203.0.113.1	*	203.0.113.4	21/tcp	274/300	*	close

State
Passive

IPv4 action count: 1 on FPC1.PIC1

Src-Addr	Src-Port	Dst-Addr	Dst-Port/Proto	Timeout(sec)	Zone	Action
203.0.113.1	*	203.0.113.4	21/tcp	274/300	*	close

State
Passive

IPv4 action count: 1 on FPC1.PIC2

Src-Addr	Src-Port	Dst-Addr	Dst-Port/Proto	Timeout(sec)	Zone	Action
203.0.113.1	*	203.0.113.4	21/tcp	273/300	*	close

State
Active

IPv4 action count: 1 on FPC1.PIC3

IPv4 action count: Active mode 1 on all PICs

IPv6 action count: 0 on FPC0.PIC1

IPv6 action count: 0 on FPC0.PIC2

IPv6 action count: 0 on FPC0.PIC3

IPv6 action count: 0 on FPC1.PIC0

IPv6 action count: 0 on FPC1.PIC1

IPv6 action count: 0 on FPC1.PIC2

IPv6 action count: 0 on FPC1.PIC3

IPv6 action count: Active mode 0 on all PICs

show security flow ip-action destination-prefix

user@host> **show security flow ip-action destination-prefix 203.0.113.4/8**

Src-Addr	Src-Port	Dst-Addr	Dst-Port/Proto	Timeout(sec)	Zone	Action
203.0.113.1	*	203.0.113.4	21/tcp	245/300	*	close

State
Passive

IPv4 action count: 1 on FPC0.PIC1

Src-Addr	Src-Port	Dst-Addr	Dst-Port/Proto	Timeout(sec)	Zone	Action
State						

```

203.0.113.1      *      203.0.113.4      21/tcp      245/300      *      close
Passive
IPv4 action count: 1 on FPC0.PIC2

Src-Addr      Src-Port Dst-Addr      Dst-Port/Proto Timeout(sec) Zone      Action
State
203.0.113.1      *      203.0.113.4      21/tcp      245/300      *      close
Passive
IPv4 action count: 1 on FPC0.PIC3

Src-Addr      Src-Port Dst-Addr      Dst-Port/Proto Timeout(sec) Zone      Action
State
192.0.2.3      *      203.0.113.4      21/tcp      245/300      *      close
Passive
IPv4 action count: 1 on FPC1.PIC0

Src-Addr      Src-Port Dst-Addr      Dst-Port/Proto Timeout(sec) Zone      Action
State
192.0.2.3      *      203.0.113.4      21/tcp      245/300      *      close
Passive
IPv4 action count: 1 on FPC1.PIC1

Src-Addr      Src-Port Dst-Addr      Dst-Port/Proto Timeout(sec) Zone      Action
State
203.0.113.1      *      203.0.113.4      21/tcp      245/300      *      close
Passive
IPv4 action count: 1 on FPC1.PIC2

Src-Addr      Src-Port Dst-Addr      Dst-Port/Proto Timeout(sec) Zone      Action
State
203.0.113.1      *      203.0.113.4      21/tcp      245/300      *      close
Active
IPv4 action count: 1 on FPC1.PIC3
IPv4 action count: Active mode 1 on all PICs

```

show security flow ip-action family inet protocol

```

user@host> show security flow ip-action family inet protocoludp
Src-Addr      Src-Port Dst-Addr      Dst-Port/Proto Timeout(sec) Zone      Action
State
203.0.113.1      *      203.0.113.4      69/udp      287/300      *

```



```

close      Passive
IPv4 action count: 1 on FPC0.PIC1

Src-Addr   Src-Port Dst-Addr   Dst-Port/Proto Timeout(sec) Zone   Action
State
203.0.113.1 *      203.0.113.4 69/udp     287/300 *    close
Passive
IPv4 action count: 1 on FPC0.PIC2

Src-Addr   Src-Port Dst-Addr   Dst-Port/Proto Timeout(sec) Zone   Action
State
203.0.113.1 *      203.0.113.4 69/udp     287/300 *    close
Passive
IPv4 action count: 1 on FPC0.PIC3

Src-Addr   Src-Port Dst-Addr   Dst-Port/Proto Timeout(sec) Zone   Action
State
203.0.113.1 *      203.0.113.4 69/udp     287/300 *
close      Active
IPv4 action count: 1 on FPC1.PIC0

Src-Addr   Src-Port Dst-Addr   Dst-Port/Proto Timeout(sec) Zone   Action
State
203.0.113.1 *      203.0.113.4 69/udp     287/300 *
close      Passive
IPv4 action count: 1 on FPC1.PIC1

Src-Addr   Src-Port Dst-Addr   Dst-Port/Proto Timeout(sec) Zone   Action
State
203.0.113.1 *      203.0.113.4 69/udp     287/300 *    close
Passive
IPv4 action count: 1 on FPC1.PIC2

Src-Addr   Src-Port Dst-Addr   Dst-Port/Proto Timeout(sec) Zone   Action
State
203.0.113.1 *      203.0.113.4 69/udp     287/300 *    close
Passive
IPv4 action count: 1 on FPC1.PIC3
IPv4 action count: Active mode 1 on all PICs

```

show security flow ip-action family inet logical-system all

```
user@host> show security flow ip-action family inet logical-system all
```

```
Src-Addr      Src-Port Dst-Addr      Dst-Port/Proto Timeout(sec) Zone      Action
State          Logical-System
203.0.113.1   *        203.0.113.4   69/udp        267/300      *
close         Passive      root-logical-system
IPv4 action count: 1 on FPC0.PIC1
```

```
Src-Addr      Src-Port Dst-Addr      Dst-Port/Proto Timeout(sec) Zone      Action
State          Logical-System
203.0.113.1   *        203.0.113.4   69/udp        267/300      *   close
Passive        root-logical-system
IPv4 action count: 1 on FPC0.PIC2
```

```
Src-Addr      Src-Port Dst-Addr      Dst-Port/Proto Timeout(sec) Zone      Action
State          Logical-System
203.0.113.1   *        203.0.113.4   69/udp        267/300      *   close
Passive        root-logical-system
IPv4 action count: 1 on FPC0.PIC3
```

```
Src-Addr      Src-Port Dst-Addr      Dst-Port/Proto Timeout(sec) Zone      Action
State          Logical-System
203.0.113.1   *        203.0.113.4   69/udp        267/300      *   close
Active         root-logical-system
IPv4 action count: 1 on FPC1.PIC0
```

```
Src-Addr      Src-Port Dst-Addr      Dst-Port/Proto Timeout(sec) Zone      Action
State          Logical-System
203.0.113.1   *        203.0.113.4   69/udp        267/300      *   close
Passive        root-logical-system
IPv4 action count: 1 on FPC1.PIC1
```

```
Src-Addr      Src-Port Dst-Addr      Dst-Port/Proto Timeout(sec) Zone      Action
State          Logical-System
203.0.113.1   *        203.0.113.4   69/udp        266/300      *   close
Passive        root-logical-system
IPv4 action count: 1 on FPC1.PIC2
```

```
Src-Addr      Src-Port Dst-Addr      Dst-Port/Proto Timeout(sec) Zone      Action
State          Logical-System
```

```

203.0.113.1      *      203.0.113.4    69/udp      266/300    *      close
Passive          root-logical-system
IPv4 action count: 1 on FPC1.PIC3
IPv4 action count: Active mode 1 on all PICs

```

show security flow ip-action source-prefix

```
user@host> show security flow ip-action source-prefix 192.0.2.3/8
```

```

Src-Addr      Src-Port Dst-Addr      Dst-Port/Proto Timeout(sec) Zone      Action
State
203.0.113.1   *      192.0.2.4    69/udp      244/300    *      close
Passive
IPv4 action count: 1 on FPC0.PIC1

Src-Addr      Src-Port Dst-Addr      Dst-Port/Proto Timeout(sec) Zone      Action
State
203.0.113.1   *      192.0.2.4    69/udp      244/300    *      close
Passive
IPv4 action count: 1 on FPC0.PIC2

Src-Addr      Src-Port Dst-Addr      Dst-Port/Proto Timeout(sec) Zone      Action
State
203.0.113.1   *      192.0.2.4    69/udp      244/300    *      close
Passive
IPv4 action count: 1 on FPC0.PIC3

Src-Addr      Src-Port Dst-Addr      Dst-Port/Proto Timeout(sec) Zone      Action
State
203.0.113.1   *      192.0.2.4    69/udp      244/300    *
close          Active
IPv4 action count: 1 on FPC1.PIC0

Src-Addr      Src-Port Dst-Addr      Dst-Port/Proto Timeout(sec) Zone      Action
State
203.0.113.1   *      192.0.2.4    69/udp      244/300    *      close
Passive
IPv4 action count: 1 on FPC1.PIC1

Src-Addr      Src-Port Dst-Addr      Dst-Port/Proto Timeout(sec) Zone      Action
State

```

```

203.0.113.1      *      192.0.2.4      69/udp      244/300      *
close      Passiveo
IPv4 action count: 1 on FPC1.PIC2

Src-Addr      Src-Port Dst-Addr      Dst-Port/Proto Timeout(sec) Zone      Action
State
203.0.113.1      *      192.0.2.4      69/udp      244/300      *
close      Passive
IPv4 action count: 1 on FPC1.PIC3
IPv4 action count: Active mode 1 on all PICs

```

show security flow ip-action summary

```
user@host> show security flow ip-action summary
```

```

IPv4 action count: 1 on FPC0.PIC1
IPv4 action count: 1 on FPC0.PIC2
IPv4 action count: 1 on FPC0.PIC3
IPv4 action count: 1 on FPC1.PIC0
IPv4 action count: 1 on FPC1.PIC1
IPv4 action count: 1 on FPC1.PIC2
IPv4 action count: 1 on FPC1.PIC3
IPv4 action count: Active mode 1 on all PICs
IPv6 action count: 0 on FPC0.PIC1
IPv6 action count: 0 on FPC0.PIC2
IPv6 action count: 0 on FPC0.PIC3
IPv6 action count: 0 on FPC1.PIC0
IPv6 action count: 0 on FPC1.PIC1
IPv6 action count: 0 on FPC1.PIC2
IPv6 action count: 0 on FPC1.PIC3
IPv6 action count: Active mode 0 on all PICs

```

show security flow ip-action summary family inet

```
user@host> show security flow ip-action summary inet
```

```

IPv4 action count: 1 on FPC0.PIC1
IPv4 action count: 1 on FPC0.PIC2
IPv4 action count: 1 on FPC0.PIC3

```

```
IPv4 action count: 1 on FPC1.PIC0
IPv4 action count: 1 on FPC1.PIC1
IPv4 action count: 1 on FPC1.PIC2
IPv4 action count: 1 on FPC1.PIC3
IPv4 action count: Active mode 1 on all PICs
```

show security flow ip-action summary family inet6

```
user@host> show security flow ip-action summary family inet6

IPv6 action count: 1 on FPC0.PIC1
IPv6 action count: 1 on FPC0.PIC2
IPv6 action count: 1 on FPC0.PIC3
IPv6 action count: 1 on FPC1.PIC0
IPv6 action count: 1 on FPC1.PIC1
IPv6 action count: 1 on FPC1.PIC2
IPv6 action count: 1 on FPC1.PIC3
IPv6 action count: Active mode 1 on all PICs
```

Release Information

Command introduced in Junos OS Release 10.1. Logical systems option added in Junos OS Release 11.2 . Summary option introduced in Junos OS Release 12.1.

RELATED DOCUMENTATION

[Understanding Traffic Processing on Security Devices | 2](#)

[clear security flow ip-action | 433](#)

[clear security flow session destination-port | 448](#)

show security flow gate brief node

IN THIS SECTION

- [Syntax | 622](#)
- [Description | 622](#)
- [Options | 622](#)
- [Required Privilege Level | 623](#)
- [Output Fields | 623](#)
- [Sample Output | 624](#)
- [Release Information | 630](#)

Syntax

```
show security flow gate brief node (node-id | all | local | primary)
```

Description

Display information about temporary openings known as pinholes or gates in the security firewall for the specified node options in brief mode.

Options

node—(Optional) For chassis cluster configurations, display gate information on a specific node.

- *node-id*—Identification number of the node. It can be 0 or 1.
- *all*—Display information about all nodes.
- *local*—Display information about the local node.

- `primary`—Display information about the primary node.

Required Privilege Level

view

Output Fields

[Table 44 on page 623](#) lists the output fields for the `show security flow gate brief node` command. Output fields are listed in the approximate order in which they appear.

Table 44: show security flow gate brief node Output Fields

Field Name	Field Description
Valid gates	Number of valid gates.
Pending gates	Number of pending gates.
Invalidated gates	Number of invalid gates.
Gates in other states	Number of gates in other states.
Total gates	Number of gates in total.
Hole	Range of flows permitted by the pinhole.
Translated	Tuples used to create the session if it matches the pinhole. <ul style="list-style-type: none"> • Source address and port • Destination address and port
Protocol	Application protocol, such as UDP or TCP.

Table 44: show security flow gate brief node Output Fields (Continued)

Field Name	Field Description
Application	Name of the application.
Age	Idle timeout for the pinhole.
Flags	Internal debug flags for the pinhole.
Zone	Incoming zone.
Reference count	Number of resource manager references to the pinhole.
Resource	Resource manager information about the pinhole.

Sample Output

show security flow gate brief node 0

```

root@antbert> show security flow gate brief node 0
node0:
-----

Flow Gates on FPC3 PIC1:

Valid gates: 0
Pending gates: 0
Invalidated gates: 0
Gates in other states: 0
Total gates: 0

Flow Gates on FPC4 PIC0:

Hole: 1.0.0.100-1.0.0.100/0-0->2.0.0.100-2.0.0.100/32707-32707

```



```

Translated: 1.0.0.100/0->2.0.0.100/32707
Protocol: tcp
Application: FTP ALG/79
Age: 65518 seconds
Flags: 0x0080
Zone: trust
Reference count: 1
Resource: 1-24576-86016

```

```

Valid gates: 1
Pending gates: 0
Invalidated gates: 0
Gates in other states: 0
Total gates: 1

```

Flow Gates on FPC4 PIC1:

```

Valid gates: 0
Pending gates: 0
Invalidated gates: 0
Gates in other states: 0
Total gates: 0

```

show security flow gate brief node 1

```

root@antbert> show security flow gate brief node 1
node1:
-----

Flow Gates on FPC3 PIC1:

Valid gates: 0
Pending gates: 0
Invalidated gates: 0
Gates in other states: 0
Total gates: 0

Flow Gates on FPC4 PIC0:

Hole: 1.0.0.100-1.0.0.100/0-0->2.0.0.100-2.0.0.100/32707-32707
Translated: 1.0.0.100/0->2.0.0.100/32707

```

```

Protocol: tcp
Application: FTP ALG/79
Age: 65514 seconds
Flags: 0x0080
Zone: trust
Reference count: 1
Resource: 1-24576-86016

```

```

Valid gates: 1
Pending gates: 0
Invalidated gates: 0
Gates in other states: 0
Total gates: 1

```

Flow Gates on FPC4 PIC1:

```

Valid gates: 0
Pending gates: 0
Invalidated gates: 0
Gates in other states: 0
Total gates: 0

```

show security flow gate brief node all

```

root@antbert> show security flow gate brief node all
node0:
-----

Flow Gates on FPC3 PIC1:

Valid gates: 0
Pending gates: 0
Invalidated gates: 0
Gates in other states: 0
Total gates: 0

Flow Gates on FPC4 PIC0:

Hole: 1.0.0.100-1.0.0.100/0-0->2.0.0.100-2.0.0.100/32707-32707
Translated: 1.0.0.100/0->2.0.0.100/32707
Protocol: tcp

```

Application: FTP ALG/79
Age: 65512 seconds
Flags: 0x0080
Zone: trust
Reference count: 1
Resource: 1-24576-86016

Valid gates: 1
Pending gates: 0
Invalidated gates: 0
Gates in other states: 0
Total gates: 1

Flow Gates on FPC4 PIC1:

Valid gates: 0
Pending gates: 0
Invalidated gates: 0
Gates in other states: 0
Total gates: 0

node1:

Flow Gates on FPC3 PIC1:

Valid gates: 0
Pending gates: 0
Invalidated gates: 0
Gates in other states: 0
Total gates: 0

Flow Gates on FPC4 PIC0:

Hole: 1.0.0.100-1.0.0.100/0-0->2.0.0.100-2.0.0.100/32707-32707
Translated: 1.0.0.100/0->2.0.0.100/32707
Protocol: tcp
Application: FTP ALG/79
Age: 65510 seconds
Flags: 0x0080
Zone: trust
Reference count: 1
Resource: 1-24576-86016

```

Valid gates: 1
Pending gates: 0
Invalidated gates: 0
Gates in other states: 0
Total gates: 1

```

Flow Gates on FPC4 PIC1:

```

Valid gates: 0
Pending gates: 0
Invalidated gates: 0
Gates in other states: 0
Total gates: 0

```

show security flow gate brief node local

```

root@antbert> show security flow gate brief node local
node0:
-----

Flow Gates on FPC3 PIC1:

Valid gates: 0
Pending gates: 0
Invalidated gates: 0
Gates in other states: 0
Total gates: 0

Flow Gates on FPC4 PIC0:

Hole: 1.0.0.100-1.0.0.100/0-0->2.0.0.100-2.0.0.100/32707-32707
  Translated: 1.0.0.100/0->2.0.0.100/32707
  Protocol: tcp
  Application: FTP ALG/79
  Age: 65504 seconds
  Flags: 0x0080
  Zone: trust
  Reference count: 1
  Resource: 1-24576-86016

```

```

Valid gates: 1
Pending gates: 0
Invalidated gates: 0
Gates in other states: 0
Total gates: 1

```

Flow Gates on FPC4 PIC1:

```

Valid gates: 0
Pending gates: 0
Invalidated gates: 0
Gates in other states: 0
Total gates: 0

```

show security flow gate brief node primary

```

root@antbert> show security flow gate brief node primary
node0:
-----

Flow Gates on FPC3 PIC1:

Valid gates: 0
Pending gates: 0
Invalidated gates: 0
Gates in other states: 0
Total gates: 0

Flow Gates on FPC4 PIC0:

Hole: 1.0.0.100-1.0.0.100/0-0->2.0.0.100-2.0.0.100/32707-32707
  Translated: 1.0.0.100/0->2.0.0.100/32707
  Protocol: tcp
  Application: FTP ALG/79
  Age: 65500 seconds
  Flags: 0x0080
  Zone: trust
  Reference count: 1
  Resource: 1-24576-86016

Valid gates: 1

```

```
Pending gates: 0
Invalidated gates: 0
Gates in other states: 0
Total gates: 1
```

```
Flow Gates on FPC4 PIC1:
```

```
Valid gates: 0
Pending gates: 0
Invalidated gates: 0
Gates in other states: 0
Total gates: 0
```

Release Information

Command introduced in Junos OS Release 8.5; node options added in Junos OS Release 9.0. Filter options added in Junos OS Release 10.2.

RELATED DOCUMENTATION

[show security flow gate | 603](#)

[show security flow gate summary node | 645](#)

show security flow gate destination-port

IN THIS SECTION

- [Syntax | 631](#)
- [Description | 631](#)
- [Options | 631](#)
- [Required Privilege Level | 631](#)
- [Output Fields | 632](#)

- [Sample Output | 633](#)
- [Release Information | 635](#)

Syntax

```
show security flow gate destination-port destination-port-number [brief | summary]
```

Description

Display information about temporary openings known as pinholes or gates in the security firewall that for the specified destination port.

NOTE: Destination port filter matches the gate only if the given port falls within the range of ports specified in the gate.

Options

- *destination-port-number*—Number of the destination port for which to display gate information.
Range: 1 through 65,535
- brief | summary—Display the specified level of output.

Required Privilege Level

view

Output Fields

Table 45 on page 632 lists the output fields for the `show security flow gate destination-port` command. Output fields are listed in the approximate order in which they appear.

Table 45: show security flow gate destination-port Output Fields

Field Name	Field Description
Hole	Range of flows permitted by the pinhole.
Translated	Tuples used to create the session if it matches the pinhole. <ul style="list-style-type: none"> • Source address and port • Destination address and port
Protocol	Application protocol, such as UDP or TCP.
Application	Name of the application.
Age	Idle timeout for the pinhole.
Flags	Internal debug flags for the pinhole.
Zone	Incoming zone.
Reference count	Number of resource manager references to the pinhole.
Resource	Resource manager information about the pinhole.
Valid gates	Number of valid gates.
Pending gates	Number of pending gates.
Invalidated gates	Number of invalid gates.

Table 45: show security flow gate destination-port Output Fields (Continued)

Field Name	Field Description
Gates in other states	Number of gates in other states.
Total gates	Number of gates in total.
Maximum gates	Number of maximum gates.

Sample Output

show security flow gate destination-port brief

```

root> show security flow gate destination-port 33253 brief
Flow Gates on FPC4 PIC1:

Hole: 40.0.0.111-40.0.0.111/0-0->30.0.0.100-30.0.0.100/33253-33253
  Translated: 40.0.0.111/0->30.0.0.100/33253
  Protocol: tcp
  Application: FTP ALG/79
  Age: 65526 seconds
  Flags: 0x0080
  Zone: trust
  Reference count: 1
  Resource: 1-24576-86016

Valid gates: 1
Pending gates: 0
Invalidated gates: 0
Gates in other states: 0
Total gates: 1

Flow Gates on FPC5 PIC0:

Valid gates: 0
Pending gates: 0

```

```
Invalidated gates: 0  
Gates in other states: 0  
Total gates: 0
```

```
Flow Gates on FPC5 PIC1:
```

```
Valid gates: 0  
Pending gates: 0  
Invalidated gates: 0  
Gates in other states: 0  
Total gates: 0
```

show security flow gate destination-port summary

```
root> show security flow gate destination-port 33253 summary
```

```
Flow Gates on FPC4 PIC1:
```

```
Valid gates: 1  
Pending gates: 0  
Invalidated gates: 0  
Gates in other states: 0  
Total gates: 1  
Maximum gates: 131072
```

```
Flow Gates on FPC5 PIC0:
```

```
Valid gates: 0  
Pending gates: 0  
Invalidated gates: 0  
Gates in other states: 0  
Total gates: 0  
Maximum gates: 131072
```

```
Flow Gates on FPC5 PIC1:
```

```
Valid gates: 0  
Pending gates: 0  
Invalidated gates: 0  
Gates in other states: 0
```

Total gates: 0
Maximum gates: 131072

Release Information

Command introduced in Junos OS Release 10.2.

RELATED DOCUMENTATION

[show security flow gate | 603](#)

[show security flow gate destination-prefix | 635](#)

show security flow gate destination-prefix

IN THIS SECTION

- [Syntax | 635](#)
- [Description | 636](#)
- [Options | 636](#)
- [Required Privilege Level | 636](#)
- [Output Fields | 636](#)
- [Sample Output | 638](#)
- [Release Information | 639](#)

Syntax

```
show security flow gate destination-prefix destination-IP-prefix [brief | summary]
```

Description

Display information about temporary openings known as pinholes or gates in the security firewall for the specified destination prefix.

NOTE: Destination prefix must match both the starting and ending address in the gate.

Options

- *destination-IP-prefix*—Destination IP prefix or address for which to display gate information.
- *brief | summary*—Display the specified level of output.

Required Privilege Level

view

Output Fields

[Table 46 on page 636](#) lists the output fields for the `show security flow gate destination-prefix` command. Output fields are listed in the approximate order in which they appear.

Table 46: show security flow gate destination-prefix Output Fields

Field Name	Field Description
Hole	Range of flows permitted by the pinhole.
Translated	Tuples used to create the session if it matches the pinhole. <ul style="list-style-type: none"> • Source address and port • Destination address and port

Table 46: show security flow gate destination-prefix Output Fields (Continued)

Field Name	Field Description
Protocol	Application protocol, such as UDP or TCP.
Application	Name of the application.
Age	Idle timeout for the pinhole.
Flags	Internal debug flags for the pinhole.
Zone	Incoming zone.
Reference count	Number of resource manager references to the pinhole.
Resource	Resource manager information about the pinhole.
Valid gates	Number of valid gates.
Pending gates	Number of pending gates.
Invalidated gates	Number of invalid gates.
Gates in other states	Number of gates in other states.
Total gates	Number of gates in total.

Sample Output

show security flow gate destination-prefix brief

```
root> show security flow gate destination-prefix 192.0.2.1 brief
Hole: 203.0.113.1-203.0.113.1/0-0->192.0.2.1-192.0.2.1/37308-37308
Translated: 203.0.113.1/0->192.0.2.1/37308
Protocol: tcp
Application: FTP ALG/79
Age: 65456 seconds
Flags: 0x0080
Zone: trust
Reference count: 1
Resource: 1-24575-86015
```

```
Valid gates: 1
Pending gates: 0
Invalidated gates: 0
Gates in other states: 0
Total gates: 1
```

Flow Gates on FPC5 PIC0:

```
Valid gates: 0
Pending gates: 0
Invalidated gates: 0
Gates in other states: 0
Total gates: 0
```

Flow Gates on FPC5 PIC1:

```
Valid gates: 0
Pending gates: 0
Invalidated gates: 0
Gates in other states: 0
Total gates: 0
```

show security flow gate destination-prefix summary

```
root> show security flow gate destination-prefix 192.0.2.1 summary
Flow Gates on FPC4 PIC1:

Valid gates: 1
Pending gates: 0
Invalidated gates: 0
Gates in other states: 0
Total gates: 1

Flow Gates on FPC5 PIC0:

Valid gates: 0
Pending gates: 0
Invalidated gates: 0
Gates in other states: 0
Total gates: 0

Flow Gates on FPC5 PIC1:

Valid gates: 0
Pending gates: 0
Invalidated gates: 0
Gates in other states: 0
Total gates: 0
```

Release Information

Command introduced in Junos OS Release 10.2.

RELATED DOCUMENTATION

[show security flow gate | 603](#)

[show security flow gate destination-port | 630](#)

show security flow gate protocol

IN THIS SECTION

- Syntax | 640
- Description | 640
- Options | 640
- Required Privilege Level | 641
- Output Fields | 641
- Sample Output | 643
- Release Information | 644

Syntax

```
show security flow gate protocol protocol-name [brief | summary]
```

Description

Display information about temporary openings known as pinholes or gates in the security firewall for the specified protocol.

Options

- *protocol-name*—Protocol to use as a gate filter. Information about gates that use this protocol is displayed.

Possible protocols are:

- ah—IP Security Authentication Header
- egp—Exterior gateway protocol

- esp—IPsec Encapsulating Security Payload
- gre—Generic routing encapsulation
- icmp—Internet Control Message Protocol
- icmp6—Internet Control Message Protocol
- igmp—Internet Group Management Protocol
- ipip—IP over IP
- ospf—Open Shortest Path First
- pim—Protocol Independent Multicast
- rsvp—Resource Reservation Protocol
- sctp—Stream Control Transmission Protocol
- tcp—Transmission Control Protocol
- udp—User Datagram Protocol
- brief | summary—Display the specified level of output.

Required Privilege Level

view

Output Fields

[Table 47 on page 641](#) lists the output fields for the `show security flow gate protocol` command. Output fields are listed in the approximate order in which they appear.

Table 47: show security flow gate protocol Output Fields

Field Name	Field Description
Hole	Range of flows permitted by the pinhole.

Table 47: show security flow gate protocol Output Fields (Continued)

Field Name	Field Description
Translated	Tuples used to create the session if it matches the pinhole. <ul style="list-style-type: none"> • Source address and port • Destination address and port
Protocol	Application protocol, such as UDP or TCP.
Application	Name of the application.
Age	Idle timeout for the pinhole.
Flags	Internal debug flags for the pinhole.
Zone	Incoming zone.
Reference count	Number of resource manager references to the pinhole.
Resource	Resource manager information about the pinhole.
Valid gates	Number of valid gates.
Pending gates	Number of pending gates.
Invalidated gates	Number of invalid gates.
Gates in other states	Number of gates in other states.
Total gates	Number of gates in total.

Sample Output

show security flow gate protocol brief

```
root> root> show security flow gate protocol tcp brief
Hole: 203.0.113.1-40.0.0.111/0-0->192.0.2.1-192.0.2.1/37308-37308
Translated: 203.0.113.1/0->30.0.0.100/37308
Protocol: tcp
Application: FTP ALG/79
Age: 65414 seconds
Flags: 0x0080
Zone: trust
Reference count: 1
Resource: 1-24575-86015
```

```
Valid gates: 1
Pending gates: 0
Invalidated gates: 0
Gates in other states: 0
Total gates: 1
```

Flow Gates on FPC5 PIC0:

```
Valid gates: 0
Pending gates: 0
Invalidated gates: 0
Gates in other states: 0
Total gates: 0
```

Flow Gates on FPC5 PIC1:

```
Valid gates: 0
Pending gates: 0
Invalidated gates: 0
Gates in other states: 0
Total gates: 0
```

show security flow gate protocol summary

```
root> show security flow gate protocol tcp summary
Flow Gates on FPC4 PIC1:

Valid gates: 1
Pending gates: 0
Invalidated gates: 0
Gates in other states: 0
Total gates: 1

Flow Gates on FPC5 PIC0:

Valid gates: 0
Pending gates: 0
Invalidated gates: 0
Gates in other states: 0
Total gates: 0

Flow Gates on FPC5 PIC1:

Valid gates: 0
Pending gates: 0
Invalidated gates: 0
Gates in other states: 0
Total gates: 0
```

Release Information

Command introduced in Junos OS Release 10.2.

RELATED DOCUMENTATION

| [show security flow gate](#) | 603

show security flow gate summary node

IN THIS SECTION

- [Syntax | 645](#)
- [Description | 645](#)
- [Options | 645](#)
- [Required Privilege Level | 646](#)
- [Output Fields | 646](#)
- [Sample Output | 647](#)
- [Release Information | 652](#)

Syntax

```
show security flow gate summary node (node-id | all | local | primary)
```

Description

Display information about temporary openings known as pinholes or gates in the security firewall for the specified node options in summary mode.

Options

`node`—(Optional) For chassis cluster configurations, display gate information on a specific node.

- `node-id`—Identification number of the node. It can be 0 or 1.
- `all`—Display information about all nodes.
- `local`—Display information about the local node.

- `primary`—Display information about the primary node.

Required Privilege Level

view

Output Fields

[Table 48 on page 646](#) lists the output fields for the `show security flow gate summary node` command. Output fields are listed in the approximate order in which they appear.

Table 48: show security flow gate summary node Output Fields

Field Name	Field Description
Valid gates	Number of valid gates.
Pending gates	Number of pending gates.
Invalidated gates	Number of invalid gates.
Gates in other states	Number of gates in other states.
Total gates	Number of gates in total.
Hole	Range of flows permitted by the pinhole.
Translated	Tuples used to create the session if it matches the pinhole. <ul style="list-style-type: none"> • Source address and port • Destination address and port
Protocol	Application protocol, such as UDP or TCP.

Table 48: show security flow gate summary node Output Fields (Continued)

Field Name	Field Description
Application	Name of the application.
Age	Idle timeout for the pinhole.
Flags	Internal debug flags for the pinhole.
Zone	Incoming zone.
Reference count	Number of resource manager references to the pinhole.
Resource	Resource manager information about the pinhole.

Sample Output

show security flow gate summary node 0

```
root@antbert> show security flow gate summary node 0
```

```
node0:
```

```
-----
```

```
Flow Gates on FPC3 PIC1:
```

```
Valid gates: 0
```

```
Pending gates: 0
```

```
Invalidated gates: 0
```

```
Gates in other states: 0
```

```
Total gates: 0
```

```
Maximum gates: 131072
```

```
Flow Gates on FPC4 PIC0:
```

```
Valid gates: 1
Pending gates: 0
Invalidated gates: 0
Gates in other states: 0
Total gates: 1
Maximum gates: 131072
```

```
Flow Gates on FPC4 PIC1:
```

```
Valid gates: 0
Pending gates: 0
Invalidated gates: 0
Gates in other states: 0
Total gates: 0
Maximum gates: 131072
```

show security flow gate summary node 1

```
root@antbert> show security flow gate summary node 1
node1:
```

```
-----
Flow Gates on FPC3 PIC1:
```

```
Valid gates: 0
Pending gates: 0
Invalidated gates: 0
Gates in other states: 0
Total gates: 0
Maximum gates: 131072
```

```
Flow Gates on FPC4 PIC0:
```

```
Valid gates: 1
Pending gates: 0
Invalidated gates: 0
Gates in other states: 0
Total gates: 1
Maximum gates: 131072
```

```
Flow Gates on FPC4 PIC1:
```



```
Valid gates: 0  
Pending gates: 0  
Invalidated gates: 0  
Gates in other states: 0  
Total gates: 0  
Maximum gates: 131072
```

show security flow gate summary node all

```
root@antbert> show security flow gate summary node all  
node0:
```

```
-----  
Flow Gates on FPC3 PIC1:
```

```
Valid gates: 0  
Pending gates: 0  
Invalidated gates: 0  
Gates in other states: 0  
Total gates: 0  
Maximum gates: 131072
```

```
Flow Gates on FPC4 PIC0:
```

```
Valid gates: 1  
Pending gates: 0  
Invalidated gates: 0  
Gates in other states: 0  
Total gates: 1  
Maximum gates: 131072
```

```
Flow Gates on FPC4 PIC1:
```

```
Valid gates: 0  
Pending gates: 0  
Invalidated gates: 0  
Gates in other states: 0  
Total gates: 0  
Maximum gates: 131072
```

```
node1:
-----

Flow Gates on FPC3 PIC1:

Valid gates: 0
Pending gates: 0
Invalidated gates: 0
Gates in other states: 0
Total gates: 0
Maximum gates: 131072

Flow Gates on FPC4 PIC0:

Valid gates: 1
Pending gates: 0
Invalidated gates: 0
Gates in other states: 0
Total gates: 1
Maximum gates: 131072

Flow Gates on FPC4 PIC1:

Valid gates: 0
Pending gates: 0
Invalidated gates: 0
Gates in other states: 0
Total gates: 0
Maximum gates: 131072
```

show security flow gate summary node local

```
root@antbert> show security flow gate summary node local
node0:
-----

Flow Gates on FPC3 PIC1:

Valid gates: 0
Pending gates: 0
Invalidated gates: 0
```

```
Gates in other states: 0  
Total gates: 0  
Maximum gates: 131072
```

```
Flow Gates on FPC4 PIC0:
```

```
Valid gates: 1  
Pending gates: 0  
Invalidated gates: 0  
Gates in other states: 0  
Total gates: 1  
Maximum gates: 131072
```

```
Flow Gates on FPC4 PIC1:
```

```
Valid gates: 0  
Pending gates: 0  
Invalidated gates: 0  
Gates in other states: 0  
Total gates: 0  
Maximum gates: 131072
```

show security flow gate summary node primary

```
root@antbert> show security flow gate summary node primary  
node0:
```

```
-----  
Flow Gates on FPC3 PIC1:
```

```
Valid gates: 0  
Pending gates: 0  
Invalidated gates: 0  
Gates in other states: 0  
Total gates: 0  
Maximum gates: 131072
```

```
Flow Gates on FPC4 PIC0:
```

```
Valid gates: 1  
Pending gates: 0
```

```
Invalidated gates: 0
Gates in other states: 0
Total gates: 1
Maximum gates: 131072
```

```
Flow Gates on FPC4 PIC1:
```

```
Valid gates: 0
Pending gates: 0
Invalidated gates: 0
Gates in other states: 0
Total gates: 0
Maximum gates: 131072
```

Release Information

Command introduced in Junos OS Release 8.5; node options added in Junos OS Release 9.0. Filter options added in Junos OS Release 10.2.

RELATED DOCUMENTATION

show security flow gate

[show security flow gate brief node](#) | 622

show security flow pmi statistics

IN THIS SECTION

- [Syntax](#) | 653
- [Description](#) | 653
- [Options](#) | 653
- [Required Privilege Level](#) | 653

- [Output Fields | 654](#)
- [Sample Output | 654](#)
- [Release Information | 656](#)

Syntax

```
show security flow pmi statistics  
<node (node-id | all | local | primary)>
```

Description

The `show security flow statistics` command displays information for individual PIC.

Options

- `none`—Display the security flow statistics information.
- `node`—(Optional) For chassis cluster configurations, display all security flow statistics on a specific node (device) in the cluster.
 - `node-id`—Identification number of the node. It can be 0 or 1.
 - `all`—Display information about all nodes.
 - `local`—Display information about the local node.
 - `primary`—Display information about the primary node.

Required Privilege Level

view

Output Fields

Table 49 on page 654 lists the output fields for the `show security flow pmi statistics` command. Output fields are listed in the approximate order in which they appear.

Table 49: show security flow statistics Output Fields

Field Name	Field Description
PMI received packets	Number of PMI inbound packets received.
PMI transmitted packets	Number of PMI outbound packets transmitted.
PMI regular flow path	Number of PMI packets returned using flow path.
PMI dropped packets	Number of PMI packets dropped
PMI encapsulation bytes	Number of PMI bytes encapsulated.
PMI decapsulation bytes	Number of PMI bytes decapsulated.
PMI encapsulation packets	Number of PMI packets encapsulated.
PMI decapsulation packets	Number of PMI packets decapsulated.

Sample Output

`show security flow statistics`

```
user@host> show security flow pmi statistics
show security flow pmi statistics
Flow power-mode-IPSec statistics:
PMI statistics of FPC2 PIC0:
  PMI received packets:          0
  PMI transmitted packets:      0
```

```

PMI regular flow path:          0
PMI dropped packets:           0
PMI encapsulation bytes:       0
PMI decapsulation bytes:       0
PMI encapsulation packets:     0
PMI decapsulation packets:     0

```

PMI statistics of FPC2 PIC1:

```

PMI received packets:          0
PMI transmitted packets:       0
PMI regular flow path:         0
PMI dropped packets:           0
PMI encapsulation bytes:       0
PMI decapsulation bytes:       0
PMI encapsulation packets:     0
PMI decapsulation packets:     0

```

PMI statistics summary:

```

PMI received packets:          0
PMI transmitted packets:       0
PMI regular flow path:         0
PMI dropped packets:           0
PMI encapsulation bytes:       0
PMI decapsulation bytes:       0
PMI encapsulation packets:     0
PMI decapsulation packets:     0

```

show security flow pmi statistics (PowerMode)

```
user@host> show security flow pmi statistics
```

```
node0:
```

```
-----
```

Flow power-mode-IPSec statistics:

```

PMI received packets:          40
PMI transmitted packets:       33
PMI regular flow path:         7
PMI dropped packets:           0
PMI encapsulation bytes:       0
PMI decapsulation bytes:       0
PMI encapsulation packets:     0

```

```
PMI decapsulation packets:          0
```

Release Information

Command introduced in Junos OS Release 19.2R1.

RELATED DOCUMENTATION

[Understanding Traffic Processing on Security Devices](#) | 2

show security flow session

IN THIS SECTION

- [Syntax](#) | 656
- [Description](#) | 657
- [Options](#) | 657
- [Required Privilege Level](#) | 660
- [Output Fields](#) | 660
- [Sample Output](#) | 664
- [Release Information](#) | 670

Syntax

```
show security flow session [filter] [brief | extensive | summary]  
<node (node-id | all | local | primary)>
```

Description

Display information about all currently active security sessions on the device. For the normal flow sessions, the `show security flow session` command displays byte counters based on IP header length. However, for sessions in Express Path mode, the statistics are collected from the IOC2 (SRX5K-MPC), IOC3 (SRX5K-MPC3-100G10G and SRX5K-MPC3-40G10G), and IOC4 (SRX5K-IOC4-MRAT and SRX5K-IOC4-10G) ASIC hardware engines and include full packet length with L2 headers. Because of this, the output displays slightly larger byte counters for sessions in Express Path mode than for the normal flow session.

Options

- *filter*—Filter the display by the specified criteria.

The following filters reduce the display to those sessions that match the criteria specified by the filter. Refer to the specific `show` command for examples of the filtered output.

advanced-anti-malware	Show advanced-anti-malware sessions. For details on the advanced-anti-malware option, see the Sky Advanced Threat Prevention CLI Reference Guide .
all-logical-systems-tenants	All multitenancy systems.
application	Predefined application name.
application-firewall	Application firewall enabled.
application-firewall-rule-set	Application firewall enabled with the specified rule set.
application-traffic-control	Application traffic control session.
application-traffic-control-rule-set	Application traffic control rule set name and rule name.
bytes-less-than	Define session's bytes-count less than a value (1..4294967295).
bytes-more-than	Define session's bytes-count more a value (1..4294967295).
conn-tag	Session connection tag (0..4294967295).
content-filtering	Display the content filtering session details.
curr-less-than	Define session's current-timeout value less than a value (1..100000).

curr-more-than	Define session's current-timeout value more than a value (1..100000).
destination-port	Destination port.
destination-prefix	Destination IP prefix or address.
dynamic-application	Dynamic application.
dynamic-application-group	Dynamic application.
duration-less-than	Define session's duration time less than a value (1..100000).
duration-more-than	Define session's duration time more than a value (1..100000).
encrypted	Encrypted traffic.
family	Display session by family.
ha-link	Display HA link session information.
idp	IDP-enabled sessions.
interface	Name of incoming or outgoing interface.
logical-system (all <i>logical-system-name</i>)	Name of a specific logical system or all to display all logical systems.
nat	Display sessions with network address translation.
node	(Optional) For chassis cluster configurations, display security flow session information on a specific node (device) in the cluster. <ul style="list-style-type: none"> • <i>node-id</i> —Identification number of the node. It can be 0 or 1. • all —Display information about all nodes. • local —Display information about the local node. • primary—Display information about the primary node.
packets-less-than	Define session's packets-count less than a value (1..4294967295).
packets-more-than	Define session's packets-count more than a value (1..4294967295).
plugin-name	Plugin name.
plugin-status	Plugin status.
plugins	Display the flow session information of plugins.

policy-id	Display session information based on policy ID; the range is 1 through 4,294,967,295.
pretty	Display the flow session information in a list to make it easy for you to read and monitor.
protocol	IP protocol number.
resource-manager	Resource manager.
root-logical-system	Display root logical system as default.
security-intelligence	Display security intelligence sessions.
services-offload	Display services offload sessions.
session-identifier	Display session with specified session identifier.
session-state	Session state.
source-port	Source port.
source-prefix	Source IP prefix.
ssl	Display the SSL proxy sessions information.
tenant	Displays the security flow session information for a tenant system.
timeout-less-than	Define session's timeout value less than a value (1..100000).
timeout-more-than	Define session's timeout value more than a value (1..100000).
tunnel	Tunnel sessions.
tunnel-inspection-type	Tunnel inspection type <ul style="list-style-type: none"> gre Displays gre tunnel inspection ipip Displays ipip tunnel inspection vxlan Displays vxlan tunnel inspection
vxlan-vni	It only lists the tunnel session which vni matches the one you specify in the command.
url-category	Display flow session information by url-category.
vrf-group	Display flow session information by L3VPN VRF Group.

web-filtering Display the web filtering sessions details.

- `brief` | `extensive` | `summary`—Display the specified level of output.
- `none`—Display information about all active sessions.

Required Privilege Level

view

Output Fields

[Table 50 on page 660](#) lists the output fields for the `show security flow session` command. Output fields are listed in the approximate order in which they appear.

Table 50: show security flow session Output Fields

Field Name	Field Description	Level of Output
Session ID	Number that identifies the session. Use this ID to get more information about the session.	brief extensive none
If	Interface name.	brief none
State	Status of security flow session.	brief extensive none

Table 50: show security flow session Output Fields (Continued)

Field Name	Field Description	Level of Output
Conn Tag	A 32-bit connection tag that uniquely identifies the GPRS tunneling protocol, user plane (GTP-U) and the Stream Control Transmission Protocol (STCP) sessions. The connection tag for GTP-U is the tunnel endpoint identifier (TEID) and for SCTP is the vTag. The connection ID remains 0 if the connection tag is not used by the sessions.	brief extensive none
CP Session ID	Number that identifies the central point session. Use this ID to get more information about the central point session.	brief extensive none
Policy name	Name and ID of the policy that the first packet of the session matched.	brief extensive none
Timeout	Idle timeout after which the session expires.	brief extensive none
In	Incoming flow (source and destination IP addresses, application protocol, interface, session token, route, gateway, tunnel, port sequence, FIN sequence, FIN state, packets and bytes).	brief extensive none
Bytes	Number of received and transmitted bytes.	brief extensive none

Table 50: show security flow session Output Fields (Continued)

Field Name	Field Description	Level of Output
Pkts	Number of received and transmitted packets.	brief extensive none
Total sessions	Total number of sessions.	brief extensive none
Out	Reverse flow (source and destination IP addresses, application protocol, interface, session token, route, gateway, tunnel, port sequence, FIN sequence, FIN state, packets and bytes).	brief extensive none
Status	Session status.	extensive
Flag	Internal flag depicting the state of the session, used for debugging purposes.	extensive
Source NAT pool	The name of the source pool where NAT is used.	extensive
Dynamic application	Name of the application.	extensive
Application traffic control rule-set	AppQoS rule set for this session.	extensive
Rule	AppQoS rule for this session.	extensive
Maximum timeout	Maximum session timeout.	extensive

Table 50: show security flow session Output Fields (Continued)

Field Name	Field Description	Level of Output
Current timeout	Remaining time for the session unless traffic exists in the session.	extensive
Session State	Session state.	extensive
Start time	Time when the session was created, offset from the system start time.	extensive
Unicast-sessions	Number of unicast sessions.	Summary
Multicast-sessions	Number of multicast sessions.	Summary
Services-offload-sessions	Number of services-offload sessions.	Summary
Failed-sessions	Number of failed sessions.	Summary
Sessions-in-use	Number of sessions in use. <ul style="list-style-type: none"> • Valid sessions • Pending sessions • Invalidated sessions • Sessions in other states 	Summary
Maximum-sessions	Maximum number of sessions permitted.	Summary

Sample Output

show security flow session

```

root> show security flow session
Flow Sessions on FPC0 PIC1:

Session ID: 10115977, Policy name: SG/4, State: Active, Timeout: 56, Valid
  In: 203.0.113.1/1000 --> 203.0.113.11/2000;udp, Conn Tag: 0x0, If: reth1.0, Pkts: 1, Bytes:
86, CP Session ID: 10320276
  Out: 203.0.113.11/2000 --> 203.0.113.1/1000;udp, Conn Tag: 0x0, If: reth0.0, Pkts: 0, Bytes:
0, CP Session ID: 10320276

Total sessions: 1

```

show security flow session (with default policy)

```

root> show security flow session
Session ID: 36, Policy name: pre-id-default-policy/n, Timeout: 2, Valid
  In: 10.10.10.2/61606 --> 10.10.10.1/179;tcp, Conn Tag: 0x0, If: ge-0/0/2.0, Pkts: 1, Bytes: 64,
  Out: 10.10.10.1/179 --> 10.10.10.2/61606;tcp, Conn Tag: 0x0, If: .local..0, Pkts: 1, Bytes: 40,

```

show security flow session (drop flow)

Shows dropped flows for SRX5400.

```

root> show security flow session
Outgoing wing:  CP session ID: 12, CP sess SPU Id: 4617  1.0.0.1/55069 <- 1.0.0.254/23;6,
Conn, Drop Flow

Tag: 0x0, VRF GRP ID: 0(0), If: xe-1/0/0.0 (7), Flag: 0x40000020, Vector index: 0x00000002
WSF: 1, Diff: 0, Sequence: 0, Ack: 0, Port sequence: 0, FIN sequence: 0, FIN state: 0  Zone Id:
7, NH: 0x40010, NSP tunnel: 0x0, NP info: 0xffthread id:255

```

show security flow session (IPv6 tunnel)

```

root> show security flow session
Session ID: 44, Policy name: N/A, State: Stand-alone, Timeout: N/A, Valid
  In: 9001::4/1 --> 9001::3/1;ipip, Conn Tag: 0x0, If: ge-0/0/0.0, Pkts: 0, Bytes: 0,

Session ID: 45, Policy name: N/A, State: Stand-alone, Timeout: N/A, Valid
  In: 9001::4/1 --> 9001::3/1;ipv6, Conn Tag: 0x0, If: ge-0/0/0.0, Pkts: 0, Bytes: 0,

Session ID: 57, Policy name: default-policy-logical-system-00/2, State: Stand-alone, Timeout:
1796, Valid
  In: 20.0.0.2/37628 --> 30.0.0.2/22;tcp, Conn Tag: 0x0, If: ge-0/0/1.0, Pkts: 22, Bytes: 4409,
  Out: 30.0.0.2/22 --> 20.0.0.2/37628;tcp, Conn Tag: 0x0, If: ip-0/0/0.1, Pkts: 30, Bytes: 5209,

Session ID: 58, Policy name: default-policy-logical-system-00/2, State: Stand-alone, Timeout:
1784, Valid
  In: 2001::2/58602 --> 3001::2/22;tcp, Conn Tag: 0x0, If: ge-0/0/1.0, Pkts: 31, Bytes: 5569,
  Out: 3001::2/22 --> 2001::2/58602;tcp, Conn Tag: 0x0, If: ip-0/0/0.1, Pkts: 28, Bytes: 6249,
Total sessions: 4

```

show security flow session brief

```

root> show security flow session brief
Flow Sessions on FPC0 PIC1:

Session ID: 10115977, Policy name: SG/4, State: Active, Timeout: 62, Valid
  In: 203.0.113.11/1000 --> 203.0.113.1/2000;udp, Conn Tag: 0x0, If: reth1.0, Pkts: 1, Bytes:
86, CP Session ID: 10320276
  Out: 203.0.113.1/2000 --> 203.0.113.11/1000;udp, Conn Tag: 0x0, If: reth0.0, Pkts: 0, Bytes:
0, CP Session ID: 10320276

Total sessions: 1

```

show security flow session content-filtering

```

root> show security flow session content-filtering
Flow Sessions on FPC0 PIC1:

Session ID: 10115977, Policy name: SG/4, State: Active, Timeout: 62, Valid

```

```

In: 192.0.2.0/24/1000 --> 203.0.113.0/2000;udp, Conn Tag: 0x0, If: reth1.0, Pkts: 1, Bytes:
86, CP Session ID: 10320276
Out: 203.0.113.0/2000 --> 192.0.2.0/24/1000;udp, Conn Tag: 0x0, If: reth0.0, Pkts: 0, Bytes:
0, CP Session ID: 10320276

```

```
Total sessions: 1
```

show security flow session extensive

```

root> show security flow session extensive
Flow Sessions on FPC0 PIC1:

Session ID: 10115977, Status: Normal, State: Active
Flags: 0x8000040/0x18000000/0x12000003
Policy name: SG/4
Source NAT pool: Null, Application: junos-gprs-gtp-v0-udp/76
Dynamic application: junos:UNKNOWN,
Encryption: Unknown
Application traffic control rule-set: INVALID, Rule: INVALID
Maximum timeout: 90, Current timeout: 54
Session State: Valid
Start time: 6704, Duration: 35
  In: 203.0.113.11/1000 --> 201.11.0.100/2000;udp,
    Conn Tag: 0x0, Interface: reth1.0,
    Session token: 0x6, Flag: 0x40000021
    Route: 0x86053c2, Gateway: 201.10.0.100, Tunnel: 0
    Port sequence: 0, FIN sequence: 0,
    FIN state: 0,
    Pkts: 1, Bytes: 86
    CP Session ID: 10320276
  Out: 203.0.113.1/2000 --> 203.0.113.11/1000;udp,
    Conn Tag: 0x0, Interface: reth0.0,
    Session token: 0x7, Flag: 0x50000000
    Route: 0x86143c2, Gateway: 203.0.113.11, Tunnel: 0
    Port sequence: 0, FIN sequence: 0,
    FIN state: 0,
    Pkts: 0, Bytes: 0
    CP Session ID: 10320276
Total sessions: 1

```

show security flow session extensive

```
root> show security flow session extensive
Flow Sessions on FPC0 PIC0:

Session ID: 10000059, Status: Normal
Flags: 0x10000/0x0/0x10/0x1
Policy name: N/A
Source NAT pool: Null
Dynamic application: junos:UNKNOWN,
Encryption: Unknown
Application traffic control rule-set: INVALID, Rule: INVALID
Maximum timeout: N/A, Current timeout: N/A
Session State: Valid
Start time: 642, Duration: 369
  In: 3.0.0.2/64387 --> 2.0.0.1/8940;esp,
  Conn Tag: 0x0, Interface: xe-2/0/2.0,
  Session token: 0x7, Flag: 0x80100621
  Route: 0xc0010, Gateway: 2.0.0.2, Tunnel: 0
  ESP/AH frag Rx: 0, Generated: 0
  Inner IPv4 frag Rx: 0, Tx: 0, Generated: 0,
  Inner IPv6 frag Rx: 0, Tx: 0, Generated: 0
  Port sequence: 0, FIN sequence: 0,
  FIN state: 0,
  Pkts: 25, Bytes: 3760
  CP Session ID: 0

Session ID: 10000060, Status: Normal
Flags: 0x10000/0x0/0x10/0x1
Policy name: N/A
Source NAT pool: Null
Dynamic application: junos:UNKNOWN,
Encryption: Unknown
Application traffic control rule-set: INVALID, Rule: INVALID
Maximum timeout: N/A, Current timeout: N/A
Session State: Valid
Start time: 642, Duration: 369
  In: 3.0.0.2/0 --> 2.0.0.1/0;esp,
  Conn Tag: 0x0, Interface: xe-2/0/2.0,
  Session token: 0x7, Flag: 0x621
  Route: 0xc0010, Gateway: 2.0.0.2, Tunnel: 0
  ESP/AH frag Rx: 0, Generated: 0
```

```
Inner IPv4 frag Rx: 0, Tx: 0, Generated: 0,  
Inner IPv6 frag Rx: 0, Tx: 0, Generated: 0  
Port sequence: 0, FIN sequence: 0,  
FIN state: 0,  
Pkts: 0, Bytes: 0  
CP Session ID: 0  
Total sessions: 2
```

show security flow session summary

```
root> show security flow session summary  
Flow Sessions on FPC10 PIC1:  
Unicast-sessions: 1  
Multicast-sessions: 0  
Services-offload-sessions: 0  
Failed-sessions: 0  
Sessions-in-use: 1  
  Valid sessions: 1  
  Pending sessions: 0  
  Invalidated sessions: 0  
  Sessions in other states: 0  
Maximum-sessions: 6291456  
  
Flow Sessions on FPC10 PIC2:  
Unicast-sessions: 0  
Multicast-sessions: 0  
Services-offload-sessions: 0  
Failed-sessions: 0  
Sessions-in-use: 0  
  Valid sessions: 0  
  Pending sessions: 0  
  Invalidated sessions: 0  
  Sessions in other states: 0  
Maximum-sessions: 6291456  
  
Flow Sessions on FPC10 PIC3:  
Unicast-sessions: 0  
Multicast-sessions: 0  
Services-offload-sessions: 0  
Failed-sessions: 0  
Sessions-in-use: 0
```

```

Valid sessions: 0
Pending sessions: 0
Invalidated sessions: 0
Sessions in other states: 0
Maximum-sessions: 6291456

```

show security flow session tunnel-inspection-type

```

root> show security flow session tunnel-inspection-type vxlan
Session ID: 335544369, Policy name: p1/7, Timeout: 2, Valid
In: 192.168.200.100/19183 --> 192.168.200.101/2;icmp, Conn Tag: 0xfcd, If: xe-7/0/0.0, Pkts: 2,
Bytes: 2048, CP Session ID: 30, Tunnel Session ID: 268435486, Type: VXLAN, VNI: 1000
Out: 192.168.200.101/2 --> 192.168.200.100/19183;icmp, Conn Tag: 0xfcd, If: xe-7/0/1.0, Pkts: 2,
Bytes: 2048, CP Session ID: 30, Tunnel Session ID: 268435488, Type: VXLAN, VNI: 1000

```

show security flow session tunnel-inspection-type

```

root> show security flow session vxlan-vni 400
Session ID: 1677861258, Policy name: pset1_p1/6, Timeout: 2, Valid
In: 192.150.0.12/55908 --> 192.160.0.66/80;tcp, Conn Tag: 0xfcd, If: xe-3/0/0.0, Pkts: 5, Bytes:
465, CP Session ID: 7021087,
Type: VXLAN, VNI: 400, Tunnel Session ID: 1680264845
Out: 192.160.0.66/80 --> 192.150.0.12/55908;tcp, Conn Tag: 0xfcd, If: xe-3/0/1.0, Pkts: 3,
Bytes: 328, CP Session ID: 7021087,
Type: VXLAN, VNI: 400, Tunnel Session ID: 1679640460

Session ID: 1678454648, Policy name: pset1_p1/6, Timeout: 2, Valid
In: 192.150.0.13/56659 --> 192.160.0.67/80;tcp, Conn Tag: 0xfcd, If: xe-3/0/0.0, Pkts: 5, Bytes:
465, CP Session ID: 5589311,
Type: VXLAN, VNI: 400, Tunnel Session ID: 1679698941
Out: 192.160.0.67/80 --> 192.150.0.13/56659;tcp, Conn Tag: 0xfcd, If: xe-3/0/1.0, Pkts: 3,
Bytes: 328, CP Session ID: 5589311,
Type: VXLAN, VNI: 400, Tunnel Session ID: 1679872223

```

show security flow session web-filtering

```
root> show security flow session web-filtering
Session ID: 256, Policy name: p/4, Timeout: 1794, Session State: Valid
  In: 198.51.100.0/33170 --> 203.0.113.0/443;tcp, Conn Tag: 0x0, If: ge-0/0/0.0, Pkts: 3, Bytes:
351,
  Out: 203.0.113.0/443 --> 192.0.2.0/13089;tcp, Conn Tag: 0x0, If: ge-0/0/2.0, Pkts: 1, Bytes:
44,
Total sessions: 1
```

Release Information

Command introduced in Junos OS Release 8.5.

Support for filter and view options added in Junos OS Release 10.2.

Application firewall, dynamic application, and logical system filters added in Junos OS Release 11.2.

Policy ID filter added in Junos OS Release 12.3X48-D10.

Support for connection tag added in Junos OS Release 15.1X49-D40.

The tenant option introduced in Junos OS Release 18.3R1.

The tunnel-inspection-type option is introduced in Junos OS Release 20.4R1.

The content filtering and Web filtering filtering options are introduced in Junos OS Release 23.1R1.

RELATED DOCUMENTATION

[Understanding Traffic Processing on Security Devices](#)

[clear security flow session all](#)

show security flow session brief node

IN THIS SECTION

- [Syntax | 671](#)
- [Description | 671](#)
- [Options | 671](#)
- [Required Privilege Level | 672](#)
- [Output Fields | 672](#)
- [Sample Output | 673](#)
- [Release Information | 676](#)

Syntax

```
show security flow session brief node (node-id | all | local | primary)
```

Description

Display information about all currently active security sessions on the device for the specified node options in brief mode.

Options

node—(Optional) For chassis cluster configurations, display session information on a specific node.

- *node-id*—Identification number of the node. It can be 0 or 1.
- *all*—Display information about all nodes.
- *local*—Display information about the local node.

- `primary`—Display information about the primary node.

Required Privilege Level

view

Output Fields

[Table 51 on page 672](#) lists the output fields for the `show security flow session brief node` command. Output fields are listed in the approximate order in which they appear.

Table 51: show security flow session brief node Output Fields

Field Name	Field Description
Session ID	Number that identifies the session. Use this ID to get more information about the session.
Policy name	Policy that permitted the traffic.
State	Session state.
Timeout	Idle timeout after which the session expires.
In	Incoming flow (source and destination IP addresses, application protocol, interface, session token, route, gateway, tunnel, port sequence, FIN sequence, FIN state, packets and bytes).
Out	Reverse flow (source and destination IP addresses, application protocol, interface, session token, route, gateway, tunnel, port sequence, FIN sequence, FIN state, packets and bytes).
CP Session ID	Number that identifies the central point session. Use this ID to get more information about the central point session.

Table 51: show security flow session brief node Output Fields (Continued)

Field Name	Field Description
Total sessions	Total number of sessions.

Sample Output

show security flow session brief node 0

```

root@host> show security flow session brief node 0
node0:
-----

Flow Sessions on FPC0 PIC1:

Session ID: 10000001, Policy name: default-policy-00/2, State: Active, Timeout: 1696, Valid
Resource information : FTP ALG, 1, 0
  In: 203.0.113.1/60059 --> 203.0.113.2/21;tcp, If: reth0.0, Pkts: 14, Bytes: 626, CP Session
ID: 10000001
  Out: 203.0.113.2/21 --> 203.0.113.1/60059;tcp, If: reth1.0, Pkts: 13, Bytes: 744, CP Session
ID: 10000001

Total sessions: 1

Flow Sessions on FPC0 PIC2:
Total sessions: 0

Flow Sessions on FPC0 PIC3:
Total sessions: 0

```

show security flow session brief node 1

```

root@host> show security flow session brief node 1
node1:

```

```
-----
```

Flow Sessions on FPC0 PIC1:

Session ID: 10000001, Policy name: default-policy-00/2, State: Active, Timeout: 1696, Valid

Resource information : FTP ALG, 1, 0

In: 203.0.113.1/60059 --> 203.0.113.2/21;tcp, If: reth0.0, Pkts: 14, Bytes: 626, CP Session ID: 10000001

Out: 203.0.113.2/21 --> 203.0.113.1/60059;tcp, If: reth1.0, Pkts: 13, Bytes: 744, CP Session ID: 10000001

Total sessions: 1

Flow Sessions on FPC0 PIC2:

Total sessions: 0

Flow Sessions on FPC0 PIC3:

Total sessions: 0

show security flow session brief node all

```
root@host> show security flow session brief node all
```

```
node0:
```

```
-----
```

Session ID: 10000001, Policy name: default-policy-00/2, State: Active, Timeout: 1696, Valid

Resource information : FTP ALG, 1, 0

In: 203.0.113.1/60059 --> 203.0.113.2/21;tcp, If: reth0.0, Pkts: 14, Bytes: 626, CP Session ID: 10000001

Out: 203.0.113.2/21 --> 203.0.113.1/60059;tcp, If: reth1.0, Pkts: 13, Bytes: 744, CP Session ID: 10000001

Total sessions: 1

Flow Sessions on FPC0 PIC2:

Total sessions: 0

Flow Sessions on FPC0 PIC3:

Total sessions: 0

```
node1:
```

```
-----
```

Flow Sessions on FPC0 PIC1:

Session ID: 10000001, Policy name: default-policy-00/2, State: Active, Timeout: 1696, Valid

Resource information : FTP ALG, 1, 0

In: 203.0.113.1/60059 --> 203.0.113.2/21;tcp, If: reth0.0, Pkts: 14, Bytes: 626, CP Session ID: 10000001

Out: 203.0.113.2/21 --> 203.0.113.1/60059;tcp, If: reth1.0, Pkts: 13, Bytes: 744, CP Session ID: 10000001

Total sessions: 1

Flow Sessions on FPC0 PIC2:

Total sessions: 0

Flow Sessions on FPC0 PIC3:

Total sessions: 0

show security flow session brief node local

```
root@host> show security flow session brief node local
```

```
node0:
```

```
-----
```

Flow Sessions on FPC0 PIC1:

Session ID: 10000001, Policy name: default-policy-00/2, State: Active, Timeout: 1696, Valid

Resource information : FTP ALG, 1, 0

In: 203.0.113.1/60059 --> 203.0.113.2/21;tcp, If: reth0.0, Pkts: 14, Bytes: 626, CP Session ID: 10000001

Out: 203.0.113.2/21 --> 203.0.113.1/60059;tcp, If: reth1.0, Pkts: 13, Bytes: 744, CP Session ID: 10000001

Total sessions: 1

Flow Sessions on FPC0 PIC2:

Total sessions: 0

Flow Sessions on FPC0 PIC3:

Total sessions: 0

show security flow session brief node primary

```
root@host> show security flow session brief node primary
node0:
-----

Flow Sessions on FPC0 PIC1:

Session ID: 10000001, Policy name: default-policy-00/2, State: Active, Timeout: 1696, Valid
Resource information : FTP ALG, 1, 0
  In: 203.0.113.1/60059 --> 203.0.113.2/21;tcp, If: reth0.0, Pkts: 14, Bytes: 626, CP Session
ID: 10000001
  Out: 203.0.113.2/21 --> 203.0.113.1/60059;tcp, If: reth1.0, Pkts: 13, Bytes: 744, CP Session
ID: 10000001

Flow Sessions on FPC0 PIC2:
Total sessions: 0

Flow Sessions on FPC0 PIC3:
Total sessions: 0
```

Release Information

Command introduced in Junos OS Release 8.5; node options added in Junos OS Release 9.0. Filter options added in Junos OS Release 10.2.

RELATED DOCUMENTATION

[Understanding Traffic Processing on Security Devices | 2](#)

show security flow session

show security flow session destination-port

IN THIS SECTION

- [Syntax | 677](#)
- [Description | 677](#)
- [Options | 677](#)
- [Required Privilege Level | 678](#)
- [Output Fields | 678](#)
- [Sample Output | 680](#)
- [Release Information | 682](#)

Syntax

```
show security flow session destination-port  
    destination-port-number [brief | extensive | summary]
```

Description

Display information about each session that uses the specified destination port.

Options

- *destination-port-number* —Number of the destination port for which to display sessions information.
- **Range:** 1 through 65,535

brief | extensive | summary

Display the specified level of output.

Required Privilege Level

view

Output Fields

Table 52 on page 678 lists the output fields for the `show security flow session destination-port` command. Output fields are listed in the approximate order in which they appear.

Table 52: show security flow session destination-port Output Fields

Field Name	Field Description
Session ID	Number that identifies the session. You can use this ID to get additional information about the session.
Policy name	Policy that permitted the traffic.
Timeout	Idle timeout after which the session expires.
In	Incoming flow (source and destination IP addresses, application protocol, interface, session token, route, gateway, tunnel, port sequence, FIN sequence, FIN state, packets and bytes).
Out	Reverse flow (source and destination IP addresses, application protocol, interface, session token, route, gateway, tunnel, port sequence, FIN sequence, FIN state, packets and bytes).
Total sessions	Total number of sessions.
Status	Session status.
Flag	Internal flag depicting the state of the session, used for debugging purposes.
Policy name	Name and ID of the policy that the first packet of the session matched.

Table 52: show security flow session destination-port Output Fields (Continued)

Field Name	Field Description
Source NAT pool	The name of the source pool where NAT is used.
Application	Name of the application.
Maximum timeout	Maximum session timeout.
Current timeout	Remaining time for the session unless traffic exists in the session.
Session State	Session state.
Start time	Time when the session was created, offset from the system start time.
Unicast-sessions	Number of unicast sessions.
Multicast-sessions	Number of multicast sessions.
Failed-sessions	Number of failed sessions.
Sessions-in-use	Number of sessions in use. <ul style="list-style-type: none"> • Valid sessions • Pending sessions • Invalidated sessions • Sessions in other states
Maximum-sessions	Number of maximum sessions.

Sample Output

show security flow session destination-port 23

```
root> show security flow session destination-port 23
Flow Sessions on FPC10 PIC1:
Total sessions: 0

Flow Sessions on FPC10 PIC2:
Total sessions: 0

Flow Sessions on FPC10 PIC3:

Session ID: 430000098, Policy name: default-policy-00/2, Timeout: 1778, Valid
  In: 198.51.100.10/15190 --> 198.51.100.2/23;tcp, If: ge-7/1/0.0, Pkts: 109, Bytes: 5874, CP
Session ID: 430000093
  Out: 198.51.100.2/23 --> 198.51.100.10/15190;tcp, If: ge-7/1/1.0, Pkts: 64, Bytes: 4015, CP
Session ID: 430000093
Total sessions: 1
```

show security flow session destination-port 23 brief

```
root> show security flow session destination-port 23 brief
Flow Sessions on FPC10 PIC1:
Total sessions: 0

Flow Sessions on FPC10 PIC2:
Total sessions: 0

Flow Sessions on FPC10 PIC3:

Session ID: 430000098, Policy name: default-policy-00/2, Timeout: 1778, Valid
  In: 198.51.100.10/15190 --> 198.51.100.2/23;tcp, If: ge-7/1/0.0, Pkts: 109, Bytes: 5874, CP
Session ID: 430000093
  Out: 198.51.100.2/23 --> 198.51.100.10/15190;tcp, If: ge-7/1/1.0, Pkts: 64, Bytes: 4015, CP
Session ID: 430000093
Total sessions: 1
```

show security flow session destination-port 23 extensive

```
root> show security flow session destination-port 23 extensive
Flow Sessions on FPC10 PIC1:
Total sessions: 0

Flow Sessions on FPC10 PIC2:
Total sessions: 0

Flow Sessions on FPC10 PIC3:

Session ID: 430000098, Status: Normal
Flags: 0x40/0x0/0x2008003
Policy name: default-policy-00/2
Source NAT pool: Null, Application: junos-telnet/10
Dynamic application: junos:UNKNOWN,
Encryption: Unknown
Application traffic control rule-set: INVALID, Rule: INVALID
Maximum timeout: 1800, Current timeout: 1630
Session State: Valid
Start time: 65490, Duration: 207
  In: 198.51.100.10/15190 --> 198.51.100.2/23;tcp
    Interface: ge-7/1/0.0,
    Session token: 0x6, Flag: 0xc0001021
    Route: 0xa0010, Gateway: 200.0.0.10, Tunnel: 0
    Port sequence: 0, FIN sequence: 0,
    FIN state: 0,
    Pkts: 109, Bytes: 5874
    CP Session ID: 430000093
  Out: 198.51.100.2/23 --> 2198.51.100.10/15190;tcp,
    Interface: ge-7/1/1.0,
    Session token: 0x7, Flag: 0xc0001020
    Route: 0x80010, Gateway: 60.0.0.2, Tunnel: 0
    Port sequence: 0, FIN sequence: 0,
    FIN state: 0,
    Pkts: 64, Bytes: 4015
    CP Session ID: 430000093
Total sessions: 1
```

show security flow session destination-port 23 summary

```
root> show security flow session destination-port 23 summary
Flow Sessions on FPC10 PIC1:

Valid sessions: 0
Pending sessions: 0
Invalidated sessions: 0
Sessions in other states: 0
Total sessions: 0

Flow Sessions on FPC10 PIC2:

Valid sessions: 0
Pending sessions: 0
Invalidated sessions: 0
Sessions in other states: 0
Total sessions: 0

Flow Sessions on FPC10 PIC3:

Valid sessions: 1
Pending sessions: 0
Invalidated sessions: 0
Sessions in other states: 0
Total sessions: 1
```

Release Information

Command introduced in Junos OS Release 8.5; Filter and view options added in Junos OS Release 10.2.

RELATED DOCUMENTATION

[Understanding Traffic Processing on Security Devices | 2](#)

[clear security flow session destination-port | 448](#)

show security flow session destination-prefix

IN THIS SECTION

- [Syntax | 683](#)
- [Description | 683](#)
- [Options | 683](#)
- [Required Privilege Level | 684](#)
- [Output Fields | 684](#)
- [Sample Output | 686](#)
- [Release Information | 689](#)

Syntax

```
show security flow session destination-prefix  
    destination-IP-prefix [brief | extensive | summary]
```

Description

Display information about each session that matches the specified IP destination prefix.

Options

- *destination-IP-prefix*—Destination IP prefix or address for which to display session information.
- `brief | extensive | summary`—Display the specified level of output.

Required Privilege Level

view

Output Fields

[Table 53 on page 684](#) lists the output fields for the `show security flow session destination-prefix` command. Output fields are listed in the approximate order in which they appear.

Table 53: show security flow session destination-prefix Output Fields

Field Name	Field Description
Session ID	Number that identifies the session. You can use this ID to get additional information about the session.
Policy name	Policy that permitted the traffic.
Timeout	Idle timeout after which the session expires.
In	Incoming flow (source and destination IP addresses, application protocol, interface, session token, route, gateway, tunnel, port sequence, FIN sequence, FIN state, packets and bytes).
Out	Reverse flow (source and destination IP addresses, application protocol, interface, session token, route, gateway, tunnel, port sequence, FIN sequence, FIN state, packets and bytes).
Total sessions	Total number of sessions.
Status	Session status.
Flag	Internal flag depicting the state of the session, used for debugging purposes.
Policy name	Name and ID of the policy that the first packet of the session matched.

Table 53: show security flow session destination-prefix Output Fields (Continued)

Field Name	Field Description
Source NAT pool	The name of the source pool where NAT is used.
Application	Name of the application.
Maximum timeout	Maximum session timeout.
Current timeout	Remaining time for the session unless traffic exists in the session.
Session State	Session state.
Start time	Time when the session was created, offset from the system start time.
Unicast-sessions	Number of unicast sessions.
Multicast-sessions	Number of multicast sessions.
Failed-sessions	Number of failed sessions.
Sessions-in-use	Number of sessions in use. <ul style="list-style-type: none"> • Valid sessions • Pending sessions • Invalidated sessions • Sessions in other states
Maximum-sessions	Number of maximum sessions.

Sample Output

show security flow session destination-prefix 198.51.100.1/24

```
root> show security flow session destination-prefix 198.51.100.1/24
Flow Sessions on FPC10 PIC1:
Total sessions: 0

Flow Sessions on FPC10 PIC2:
Total sessions: 0

Flow Sessions on FPC10 PIC3:

Session ID: 430000098, Policy name: default-policy-00/2, Timeout: 1450, Valid
  In: 192.0.2.10/15190 --> 198.51.100.1/23;tcp, If: ge-7/1/0.0, Pkts: 109, Bytes: 5874, CP
Session ID: 430000093
  Out: 198.51.100.1/23 --> 192.0.2.10/15190;tcp, If: ge-7/1/1.0, Pkts: 64, Bytes: 4015, CP
Session ID: 430000093
Total sessions: 1
```

show security flow session destination-prefix 198.51.100.1/24 brief

```
root> show security flow session destination-prefix 198.51.100.1/24 brief
Flow Sessions on FPC10 PIC1:
Total sessions: 0

Flow Sessions on FPC10 PIC2:
Total sessions: 0

Flow Sessions on FPC10 PIC3:

Session ID: 430000098, Policy name: default-policy-00/2, Timeout: 1450, Valid
  In: 192.0.2.10/15190 --> 198.51.100.1/23;tcp, If: ge-7/1/0.0, Pkts: 109, Bytes: 5874, CP
Session ID: 430000093
  Out: 198.51.100.1/23 --> 192.0.2.10/15190;tcp, If: ge-7/1/1.0, Pkts: 64, Bytes: 4015, CP
Session ID: 430000093
Total sessions: 1
```

show security flow session destination-prefix 198.51.100.1/24 extensive

```
root> show security flow session destination-prefix 198.51.100.1/24 extensive
Flow Sessions on FPC10 PIC1:
Total sessions: 0

Flow Sessions on FPC10 PIC2:
Total sessions: 0

Flow Sessions on FPC10 PIC3:

Session ID: 430000098, Status: Normal
Flags: 0x40/0x0/0x2008003
Policy name: default-policy-00/2
Source NAT pool: Null, Application: junos-telnet/10
Dynamic application: junos:UNKNOWN,
Encryption: Unknown
Application traffic control rule-set: INVALID, Rule: INVALID
Maximum timeout: 1800, Current timeout: 1172
Session State: Valid
Start time: 65490, Duration: 666
  In: 192.0.2.10/15190 --> 198.51.100.1/23;tcp,
    Interface: ge-7/1/0.0,
    Session token: 0x6, Flag: 0xc0001021
    Route: 0xa0010, Gateway: 200.0.0.10, Tunnel: 0
    Port sequence: 0, FIN sequence: 0,
    FIN state: 0,
    Pkts: 109, Bytes: 5874
    CP Session ID: 430000093
  Out: 198.51.100.1/23 --> 200.0.0.10/15190;tcp,
    Interface: ge-7/1/1.0,
    Session token: 0x7, Flag: 0xc0001020
    Route: 0x80010, Gateway: 60.0.0.2, Tunnel: 0
    Port sequence: 0, FIN sequence: 0,
    FIN state: 0,
    Pkts: 64, Bytes: 4015
    CP Session ID: 430000093
Total sessions: 1
```

show security flow session destination-prefix 198.51.100.1/24 summary

```
root> show security flow session destination-prefix 198.51.100.1/24 summary
Flow Sessions on FPC10 PIC1:

Valid sessions: 0
Pending sessions: 0
Invalidated sessions: 0
Sessions in other states: 0
Total sessions: 0

Flow Sessions on FPC10 PIC2:

Valid sessions: 0
Pending sessions: 0
Invalidated sessions: 0
Sessions in other states: 0
Total sessions: 0

Flow Sessions on FPC10 PIC3:

Valid sessions: 1
Pending sessions: 0
Invalidated sessions: 0
Sessions in other states: 0
Total sessions: 1
```

show security flow session destination-prefix 2001:db8::/32

```
user@host> show security flow session destination-prefix 2001:db8::/32
Session ID: 50000004, Policy name: self-traffic-policy/1, Timeout: 2
In: 10::11/42756 --> 2001:db8::1 ;icmp, If: .local..0
Out: 2001:db8::1 --> 10::11/42756;icmp, If: ge-0/3/0.0

Valid sessions: 1
Pending sessions: 0
Invalidated sessions: 0
Sessions in other states: 0
Total sessions: 1
```

Release Information

Command introduced in Junos OS Release 8.5. Support.

Support for IPv6 addresses added in Junos OS Release 10.2.

Filter and view options added in Junos OS Release 10.2.

RELATED DOCUMENTATION

[Understanding Traffic Processing on Security Devices | 2](#)

[clear security flow session destination-port | 448](#)

show security flow session extensive node

IN THIS SECTION

- [Syntax | 689](#)
- [Description | 690](#)
- [Options | 690](#)
- [Required Privilege Level | 690](#)
- [Output Fields | 690](#)
- [Sample Output | 692](#)
- [Release Information | 699](#)

Syntax

```
show security flow session extensive node (node-id | all | local | primary)
```

Description

Display information about all currently active security sessions on the device for the specified node options in extensive mode.

Options

`node`—(Optional) For chassis cluster configurations, display session information on a specific node.

- `node-id`—Identification number of the node. It can be 0 or 1.
- `all`—Display information about all nodes.
- `local`—Display information about the local node.
- `primary`—Display information about the primary node.

Required Privilege Level

view

Output Fields

[Table 54 on page 690](#) lists the output fields for the `show security flow session extensive node` command. Output fields are listed in the approximate order in which they appear.

Table 54: show security flow session extensive node Output Fields

Field Name	Field Description
Session ID	Number that identifies the session. You can use this ID to get additional information about the session.
Status	Session status.

Table 54: show security flow session extensive node Output Fields (Continued)

Field Name	Field Description
State	Session state.
Flag	Internal flag depicting the state of the session, used for debugging purposes.
Policy name	Policy that permitted the traffic.
Source NAT pool	The name of the source pool where NAT is used.
Maximum timeout	Maximum session timeout.
Current timeout	Remaining time for the session unless traffic exists in the session.
Start time	Time when the session was created, offset from the system start time.
Duration	Length of time for which the session is active.
In	Incoming flow (source and destination IP addresses, application protocol, interface, session token, flag, route, gateway, tunnel, port sequence, FIN sequence, FIN state, packets and bytes).
Out	Reverse flow (source and destination IP addresses, application protocol, interface, session token, flag, route, gateway, tunnel, port sequence, FIN sequence, FIN state, packets and bytes).
Total sessions	Total number of sessions.
CP Session ID	Number that identifies the central point session. Use this ID to get more information about the central point session.

Sample Output

show security flow session extensive node 0

```
root@host> show security flow session extensive node 0
node0:
-----

Flow Sessions on FPC0 PIC1:

Session ID: 10000003, Status: Normal, State: Active
Flags: 0x8000042/0x8000000/0x110103
Policy name: default-policy-00/2
Source NAT pool: Null, Application: junos-ftp/1
Dynamic application: junos:UNKNOWN,
Encryption: Unknown
Application traffic control rule-set: INVALID, Rule: INVALID
Maximum timeout: 1800, Current timeout: 1778
Session State: Valid
Start time: 6466, Duration: 28
  In: 10.0.2.1/52080 --> 203.0.113.1/24;tcp,
    Interface: reth0.0,
    Session token: 0x6, Flag: 0x40002621
    Route: 0x86193c2, Gateway: 100.0.0.2, Tunnel: 0
    Port sequence: 0, FIN sequence: 0,
    FIN state: 0,
    Pkts: 9, Bytes: 414
    CP Session ID: 10000004
  Out: 203.0.113.1/24 --> 10.0.2.1/52080;tcp,
    Interface: reth1.0,
    Session token: 0x6, Flag: 0x40002620
    Route: 0x86033c2, Gateway: 120.0.0.2, Tunnel: 0
    Port sequence: 0, FIN sequence: 0,
    FIN state: 0,
    Pkts: 8, Bytes: 420
    CP Session ID: 10000004
Total sessions: 1

Flow Sessions on FPC0 PIC2:
Total sessions: 0
```

Flow Sessions on FPC0 PIC3:

Total sessions: 0

show security flow session extensive node 1

```
root@host> show security flow session extensive node 1
```

```
node1:
```

```
-----
```

Flow Sessions on FPC0 PIC1:

Session ID: 10000003, Status: Normal, State: Backup

Flags: 0x10000042/0x0/0x10103

Policy name: default-policy-00/2

Source NAT pool: Null, Application: junos-ftp/1

Dynamic application: junos:UNKNOWN,

Encryption: Unknown

Application traffic control rule-set: INVALID, Rule: INVALID

Maximum timeout: 1800, Current timeout: 14324

Session State: Valid

Start time: 6248, Duration: 90

In: 110.0.2.1/52080 --> 203.0.113.1/24;tcp,

Interface: reth0.0,

Session token: 0x6, Flag: 0x60002621

Route: 0x86193c2, Gateway: 100.0.0.2, Tunnel: 0

Port sequence: 0, FIN sequence: 0,

FIN state: 0,

Pkts: 0, Bytes: 0

CP Session ID: 10000003

Out: 203.0.113.1/24 --> 10.0.2.1/52080;tcp,

Interface: reth1.0,

Session token: 0x6, Flag: 0x60002620

Route: 0x86033c2, Gateway: 120.0.0.2, Tunnel: 0

Port sequence: 0, FIN sequence: 0,

FIN state: 0,

Pkts: 0, Bytes: 0

CP Session ID: 10000003

Total sessions: 1

Flow Sessions on FPC0 PIC2:

Total sessions: 0

```
Flow Sessions on FPC0 PIC3:
Total sessions: 0
```

show security flow session extensive node all

```
root@host> show security flow session extensive node all
node0:
-----

Flow Sessions on FPC0 PIC1:

Session ID: 10000003, Status: Normal, State: Active
Flags: 0x8000042/0x8000000/0x110103
Policy name: default-policy-00/2
Source NAT pool: Null, Application: junos-ftp/1
Dynamic application: junos:UNKNOWN,
Encryption: Unknown
Application traffic control rule-set: INVALID, Rule: INVALID
Maximum timeout: 1800, Current timeout: 1692
Session State: Valid
Start time: 6466, Duration: 113
  In: 10.0.2.1/52080 --> 203.0.113.1/21;tcp,
    Interface: reth0.0,
    Session token: 0x6, Flag: 0x40002621
    Route: 0x86193c2, Gateway: 100.0.0.2, Tunnel: 0
    Port sequence: 0, FIN sequence: 0,
    FIN state: 0,
    Pkts: 9, Bytes: 414
    CP Session ID: 10000004
  Out: 203.0.113.1/21 --> 10.0.2.1/52080;tcp,
    Interface: reth1.0,
    Session token: 0x6, Flag: 0x40002620
    Route: 0x86033c2, Gateway: 120.0.0.2, Tunnel: 0
    Port sequence: 0, FIN sequence: 0,
    FIN state: 0,
    Pkts: 8, Bytes: 420
    CP Session ID: 10000004
Total sessions: 1

Flow Sessions on FPC0 PIC2:
```

Total sessions: 0

Flow Sessions on FPC0 PIC3:

Total sessions: 0

node1:

Flow Sessions on FPC0 PIC1:

Session ID: 10000003, Status: Normal, State: Backup

Flags: 0x10000042/0x0/0x10103

Policy name: default-policy-00/2

Source NAT pool: Null, Application: junos-ftp/1

Dynamic application: junos:UNKNOWN,

Encryption: Unknown

Application traffic control rule-set: INVALID, Rule: INVALID

Maximum timeout: 1800, Current timeout: 14298

Session State: Valid

Start time: 6248, Duration: 115

In: 10.0.2.1/52080 --> 203.0.113.1/21;tcp,

Interface: reth0.0,

Session token: 0x6, Flag: 0x60002621

Route: 0x86193c2, Gateway: 100.0.0.2, Tunnel: 0

Port sequence: 0, FIN sequence: 0,

FIN state: 0,

Pkts: 0, Bytes: 0

CP Session ID: 10000003

Out: 203.0.113.1/21 --> 10.0.2.1/52080;tcp,

Interface: reth1.0,

Session token: 0x6, Flag: 0x60002620

Route: 0x86033c2, Gateway: 120.0.0.2, Tunnel: 0

Port sequence: 0, FIN sequence: 0,

FIN state: 0,

Pkts: 0, Bytes: 0

CP Session ID: 10000003

Total sessions: 1

Flow Sessions on FPC0 PIC2:

Total sessions: 0

Flow Sessions on FPC0 PIC3:

Total sessions: 0

show security flow session extensive node local

```
root@host> show security flow session extensive node local
```

```
node0:
```

```
-----
```

Flow Sessions on FPC0 PIC1:

Session ID: 10000003, Status: Normal, State: Active

Flags: 0x8000042/0x8000000/0x110103

Policy name: default-policy-00/2

Source NAT pool: Null, Application: junos-ftp/1

Dynamic application: junos:UNKNOWN,

Encryption: Unknown

Application traffic control rule-set: INVALID, Rule: INVALID

Maximum timeout: 1800, Current timeout: 1584

Session State: Valid

Start time: 6466, Duration: 221

In: 100.0.0.2/52080 --> 120.0.0.2/21;tcp,

Interface: reth0.0,

Session token: 0x6, Flag: 0x40002621

Route: 0x86193c2, Gateway: 100.0.0.2, Tunnel: 0

Port sequence: 0, FIN sequence: 0,

FIN state: 0,

Pkts: 9, Bytes: 414

CP Session ID: 10000004

Out: 120.0.0.2/21 --> 100.0.0.2/52080;tcp,

Interface: reth1.0,

Session token: 0x6, Flag: 0x40002620

Route: 0x86033c2, Gateway: 120.0.0.2, Tunnel: 0

Port sequence: 0, FIN sequence: 0,

FIN state: 0,

Pkts: 8, Bytes: 420

CP Session ID: 10000004

Total sessions: 1

Flow Sessions on FPC0 PIC2:

Total sessions: 0

```
Flow Sessions on FPC0 PIC3:
Total sessions: 0
```

show security flow session extensive node primary

```
root@host> show security flow session extensive node primary
node0:
```

```
-----
Flow Sessions on FPC0 PIC1:
```

```
Session ID: 10000003, Status: Normal, State: Active
Flags: 0x8000042/0x8000000/0x110103
Policy name: default-policy-00/2
Source NAT pool: Null, Application: junos-ftp/1
Dynamic application: junos:UNKNOWN,
Encryption: Unknown
Application traffic control rule-set: INVALID, Rule: INVALID
Maximum timeout: 1800, Current timeout: 1554
Session State: Valid
Start time: 6466, Duration: 252
  In: 100.0.0.2/52080 --> 120.0.0.2/21;tcp,
    Interface: reth0.0,
    Session token: 0x6, Flag: 0x40002621
    Route: 0x86193c2, Gateway: 100.0.0.2, Tunnel: 0
    Port sequence: 0, FIN sequence: 0,
    FIN state: 0,
    Pkts: 9, Bytes: 414
    CP Session ID: 10000004
  Out: 120.0.0.2/21 --> 100.0.0.2/52080;tcp,
    Interface: reth1.0,
    Session token: 0x6, Flag: 0x40002620
    Route: 0x86033c2, Gateway: 120.0.0.2, Tunnel: 0
    Port sequence: 0, FIN sequence: 0,
    FIN state: 0,
    Pkts: 8, Bytes: 420
    CP Session ID: 10000004
Total sessions: 1
```

```
Flow Sessions on FPC0 PIC2:
```

Total sessions: 0

Flow Sessions on FPC0 PIC3:

Total sessions: 0

show security flow session extensive node 0 (PowerMode)

```

root@host> show security flow session extensive node 0
node0:
-----

Session ID: 13607, Status: Normal, State: Active
Flags: 0x88000040/0x8000000/0x2/0x908003
Policy name: p1/4
Source NAT pool: Null
Dynamic application: junos:UNKNOWN,
Encryption: Unknown
Url-category: Unknown
Application traffic control rule-set: INVALID, Rule: INVALID
Maximum timeout: 150, Current timeout: 2
Session State: Valid
Start time: 443962, Duration: 3
  In: 20.1.1.2/10000 --> 30.1.1.2/2001;tcp,
  Conn Tag: 0x0, Interface: reth0.0,
  Session token: 0x8, Flag: 0x201021,
  Power-Mode Active: True
  Route: 0x33a3c2, Gateway: 20.1.1.2, Tunnel ID: 0, Tunnel type: None
  Port sequence: 0, FIN sequence: 0,
  FIN state: 2,
  Pkts: 24, Bytes: 1896
  Out: 30.1.1.2/2001 --> 20.1.1.2/10000;tcp,
  Conn Tag: 0x0, Interface: reth1.0,
  Session token: 0x7, Flag: 0x201020,
  Power-Mode Active: True
  Route: 0x326bc2, Gateway: 30.1.1.2, Tunnel ID: 0, Tunnel type: None
  Port sequence: 0, FIN sequence: 0,
  FIN state: 2,
  Pkts: 13, Bytes: 1324
Total sessions: 1

```

Release Information

Command introduced in Junos OS Release 8.5; node options added in Junos OS Release 9.0. Filter options added in Junos OS Release 10.2.

RELATED DOCUMENTATION

[Understanding Traffic Processing on Security Devices | 2](#)

[show security flow session | 656](#)

show security flow session family

IN THIS SECTION

- [Syntax | 699](#)
- [Description | 700](#)
- [Options | 700](#)
- [Required Privilege Level | 700](#)
- [Output Fields | 700](#)
- [Sample Output | 702](#)
- [Release Information | 707](#)

Syntax

```
show security flow session family (inet | inet6)
[brief | extensive | summary]
```

Description

Display filtered summary of information about existing sessions, including types of sessions, active and failed sessions, and the maximum allowed number of sessions.

Options

- `inet`—Display details summary of IPv4 sessions.
- `inet6`—Display details summary of IPv6 sessions.
- `brief | extensive | summary`—Display the specified level of output.

Required Privilege Level

view

Output Fields

[Table 55 on page 700](#) lists the output fields for the `show security flow session family` command. Output fields are listed in the approximate order in which they appear.

Table 55: show security flow session family Output Fields

Field Name	Field Description
Session ID	Number that identifies the session. Use this ID to get more information about the session.
Policy name	Policy that permitted the traffic.
Timeout	Idle timeout after which the session expires.

Table 55: show security flow session family Output Fields (Continued)

Field Name	Field Description
In	Incoming flow (source and destination IP addresses, application protocol, interface, session token, route, gateway, tunnel, port sequence, FIN sequence, FIN state, packets and bytes).
Out	Reverse flow (source and destination IP addresses, application protocol, interface, session token, route, gateway, tunnel, port sequence, FIN sequence, FIN state, packets and bytes).
Total sessions	Total number of sessions.
Status	Session status.
Flag	Internal flag depicting the state of the session, used for debugging purposes.
Policy name	Name and ID of the policy that the first packet of the session matched.
Source NAT pool	The name of the source pool where NAT is used.
Application	Name of the application.
Maximum timeout	Maximum session timeout.
Current timeout	Remaining time for the session unless traffic exists in the session.
Session State	Session state.
Start time	Time when the session was created, offset from the system start time.
Unicast-sessions	Number of unicast sessions.
Multicast-sessions	Number of multicast sessions.

Table 55: show security flow session family Output Fields (Continued)

Field Name	Field Description
Failed-sessions	Number of failed sessions.
Sessions-in-use	Number of sessions in use. <ul style="list-style-type: none"> • Valid sessions • Pending sessions • Invalidated sessions • Sessions in other states
Maximum-sessions	Number of maximum sessions.

Sample Output

show security flow session family inet

```

root> show security flow session family inet
Flow Sessions on FPC10 PIC1:
Total sessions: 0

Flow Sessions on FPC10 PIC2:

Session ID: 420000107, Policy name: default-policy-00/2, Timeout: 4, Valid
  In: 203.0.113.0/3 --> 203.0.113.5/24;icmp, If: ge-7/1/0.0, Pkts: 1, Bytes: 84, CP Session ID:
420000202
  Out: 203.0.113.4/24 --> 203.0.113.6/24;icmp, If: .local..0, Pkts: 1, Bytes: 84, CP Session ID:
420000202
Total sessions: 1

Flow Sessions on FPC10 PIC3:

Session ID: 430000115, Policy name: default-policy-00/2, Timeout: 2, Valid

```

```

In: 203.0.113.0/4 --> 203.0.113.5/24;icmp, If: ge-7/1/0.0, Pkts: 1, Bytes: 84, CP Session ID:
430000110
Out: 203.0.113.5/24 --> 203.0.113.6/24;icmp, If: .local..0, Pkts: 1, Bytes: 84, CP Session ID:
430000110

Session ID: 430000117, Policy name: default-policy-00/2, Timeout: 4, Valid
In: 203.0.113.0/4 --> 203.0.113.5/24;icmp, If: ge-7/1/0.0, Pkts: 1, Bytes: 84, CP Session ID:
430000111
Out: 203.0.113.5/24 --> 203.0.113.6/24;icmp, If: .local..0, Pkts: 1, Bytes: 84, CP Session ID:
430000111
Total sessions: 2

```

show security flow session family inet brief

```

root> show security flow session family inet brief
Flow Sessions on FPC10 PIC1:
Total sessions: 0

Flow Sessions on FPC10 PIC2:

Session ID: 420000115, Policy name: default-policy-00/2, Timeout: 2, Valid
In: 203.0.113.0/3 --> 203.0.113.5/24;icmp, If: ge-7/1/0.0, Pkts: 1, Bytes: 84, CP Session ID:
420000206
Out: 203.0.113.4/24 --> 203.0.113.6/24;icmp, If: .local..0, Pkts: 1, Bytes: 84, CP Session ID:
420000206

Session ID: 420000117, Policy name: default-policy-00/2, Timeout: 2, Valid
In: 203.0.113.0/4 --> 203.0.113.5/24;icmp, If: ge-7/1/0.0, Pkts: 1, Bytes: 84, CP Session ID:
420000207
Out: 203.0.113.5/24 --> 203.0.113.6/24;icmp, If: .local..0, Pkts: 1, Bytes: 84, CP Session ID:
420000207
Total sessions: 2

Flow Sessions on FPC10 PIC3:

Session ID: 430000119, Policy name: default-policy-00/2, Timeout: 2, Valid
In: 203.0.113.0/4 --> 203.0.113.5/24;icmp, If: ge-7/1/0.0, Pkts: 1, Bytes: 84, CP Session ID:
430000112
Out: 203.0.113.5/24 --> 203.0.113.6/24;icmp, If: .local..0, Pkts: 1, Bytes: 84, CP Session ID:

```

```
430000112
```

```
Total sessions: 1
```

show security flow session family inet extensive

```
root> show security flow session family inet extensive
Flow Sessions on FPC10 PIC1:

Session ID: 410000111, Status: Normal
Flags: 0x80400040/0x0/0x2800023
Policy name: default-policy-00/2
Source NAT pool: Null
Dynamic application: junos:UNKNOWN,
Encryption: Unknown
Application traffic control rule-set: INVALID, Rule: INVALID
Maximum timeout: 4, Current timeout: 4
Session State: Valid
Start time: 76455, Duration: 0
  In: 203.0.113.0/24 --> 203.0.113.1/24;icmp,
    Interface: ge-7/1/0.0,
    Session token: 0x6, Flag: 0xc0000021
    Route: 0xa0010, Gateway: 203.0.113.10, Tunnel: 0
    Port sequence: 0, FIN sequence: 0,
    FIN state: 0,
    Pkts: 1, Bytes: 84
    CP Session ID: 410000242
  Out: 203.0.113.1/24 --> 203.0.113.10/4;icmp,
    Interface: .local..0,
    Session token: 0x2, Flag: 0x40000030
    Route: 0xfffb0006, Gateway: 203.0.113.1, Tunnel: 0
    Port sequence: 0, FIN sequence: 0,
    FIN state: 0,
    Pkts: 1, Bytes: 84
    CP Session ID: 410000242
Total sessions: 1

Flow Sessions on FPC10 PIC2:

Session ID: 420000123, Status: Normal
Flags: 0x80400040/0x0/0x2800023
Policy name: default-policy-00/2
```



```
Source NAT pool: Null
Dynamic application: junos:UNKNOWN,
Encryption: Unknown
Application traffic control rule-set: INVALID, Rule: INVALID
Maximum timeout: 4, Current timeout: 2
Session State: Valid
Start time: 76454, Duration: 2
  In: 203.0.113.10/24 --> 203.0.113.11/24;icmp,
    Interface: ge-7/1/0.0,
    Session token: 0x6, Flag: 0xc0000021
    Route: 0xa0010, Gateway: 20010, Tunnel: 0
    Port sequence: 0, FIN sequence: 0,
    FIN state: 0,
    Pkts: 1, Bytes: 84
    CP Session ID: 420000210
  Out: 203.0.113.11/24 --> 203.0.113.12/24;icmp,
    Interface: .local..0,
    Session token: 0x2, Flag: 0x40000030
    Route: 0xffffb0006, Gateway: 203.0.113.1, Tunnel: 0
    Port sequence: 0, FIN sequence: 0,
    FIN state: 0,
    Pkts: 1, Bytes: 84
    CP Session ID: 420000210
Total sessions: 1
```

Flow Sessions on FPC10 PIC3:

```
Session ID: 430000131, Status: Normal
Flags: 0x80400040/0x0/0x2800023
Policy name: default-policy-00/2
Source NAT pool: Null
Dynamic application: junos:UNKNOWN,
Encryption: Unknown
Application traffic control rule-set: INVALID, Rule: INVALID
Maximum timeout: 4, Current timeout: 4
Session State: Valid
Start time: 76421, Duration: 1
  In: 203.0.113.10/24 --> 203.0.113.11/24;icmp,
    Interface: ge-7/1/0.0,
    Session token: 0x6, Flag: 0xc0000021
    Route: 0xa0010, Gateway: 203.0.113.10, Tunnel: 0
    Port sequence: 0, FIN sequence: 0,
    FIN state: 0,
```

```
Pkts: 1, Bytes: 84
CP Session ID: 430000118
Out: 203.0.113.12/24 --> 203.0.113.13/24;icmp,
Interface: .local..0,
Session token: 0x2, Flag: 0x40000030
Route: 0xffffb0006, Gateway: 203.0.113.1, Tunnel: 0
Port sequence: 0, FIN sequence: 0,
FIN state: 0,
Pkts: 1, Bytes: 84
CP Session ID: 430000118
Total sessions: 1
```

show security flow session family inet summary

```
root> show security flow session family inet summary
Flow Sessions on FPC10 PIC1:

Valid sessions: 2
Pending sessions: 0
Invalidated sessions: 2
Sessions in other states: 0
Total sessions: 4

Flow Sessions on FPC10 PIC2:

Valid sessions: 2
Pending sessions: 0
Invalidated sessions: 2
Sessions in other states: 0
Total sessions: 4

Flow Sessions on FPC10 PIC3:

Valid sessions: 2
Pending sessions: 0
Invalidated sessions: 2
Sessions in other states: 0
Total sessions: 4
```

Release Information

Command introduced in Junos OS Release 10.2.

RELATED DOCUMENTATION

[Understanding Traffic Processing on Security Devices | 2](#)

[clear security flow session family | 453](#)

show security flow session interface

IN THIS SECTION

- [Syntax | 707](#)
- [Description | 708](#)
- [Options | 708](#)
- [Required Privilege Level | 708](#)
- [Output Fields | 708](#)
- [Sample Output | 710](#)
- [Release Information | 713](#)

Syntax

```
show security flow session interface  
interface-name [brief | extensive | summary]
```

Description

Display information about each session that uses the specified interface. The interface name can be a session's incoming or outgoing interface.

Options

- *interface-name*—Name of the interface on the device for which to display sessions information.
- `brief` | `extensive` | `summary`—Display the specified level of output.

Required Privilege Level

view

Output Fields

[Table 56 on page 708](#) lists the output fields for the `show security flow session interface` command. Output fields are listed in the approximate order in which they appear.

Table 56: show security flow session interface Output Fields

Field Name	Field Description
Session ID	Number that identifies the session. You can use this ID to get additional information about the session.
Policy name	Policy that permitted the traffic.
Timeout	Idle timeout after which the session expires.

Table 56: show security flow session interface Output Fields (Continued)

Field Name	Field Description
In	Incoming flow (source and destination IP addresses, application protocol, interface, session token, route, gateway, tunnel, port sequence, FIN sequence, FIN state, packets and bytes).
Out	Reverse flow (source and destination IP addresses, application protocol, interface, session token, route, gateway, tunnel, port sequence, FIN sequence, FIN state, packets and bytes).
Total sessions	Total number of sessions.
Status	Session status.
Flag	Internal flag depicting the state of the session, used for debugging purposes.
Policy name	Name and ID of the policy that the first packet of the session matched.
Source NAT pool	The name of the source pool where NAT is used.
Application	Name of the application.
Maximum timeout	Maximum session timeout.
Current timeout	Remaining time for the session unless traffic exists in the session.
Session State	Session state.
Start time	Time when the session was created, offset from the system start time.
Unicast-sessions	Number of unicast sessions.
Multicast-sessions	Number of multicast sessions.

Table 56: show security flow session interface Output Fields (Continued)

Field Name	Field Description
Failed-sessions	Number of failed sessions.
Sessions-in-use	Number of sessions in use. <ul style="list-style-type: none"> • Valid sessions • Pending sessions • Invalidated sessions • Sessions in other states
Maximum-sessions	Number of maximum sessions.

Sample Output

show security flow session interface ge-0/0/2.0

```

root> show security flow session interface ge-7/1/1.0
Flow Sessions on FPC10 PIC1:
Total sessions: 0

Flow Sessions on FPC10 PIC2:

Session ID: 420000146, Policy name: default-policy-00/2, Timeout: 58, Valid
  In: 200.0.0.10/9 --> 60.0.0.2/21562;icmp, If: ge-7/1/0.0, Pkts: 1, Bytes: 84, CP Session ID:
420000247
  Out: 60.0.0.2/21562 --> 200.0.0.10/9;icmp, If: ge-7/1/1.0, Pkts: 0, Bytes: 0, CP Session ID:
420000247
Total sessions: 1

Flow Sessions on FPC10 PIC3:

Session ID: 430000146, Policy name: default-policy-00/2, Timeout: 56, Valid

```

```

In: 200.0.0.10/8 --> 60.0.0.2/21562;icmp, If: ge-7/1/0.0, Pkts: 1, Bytes: 84, CP Session ID:
430000131
Out: 60.0.0.2/21562 --> 200.0.0.10/8;icmp, If: ge-7/1/1.0, Pkts: 0, Bytes: 0, CP Session ID:
430000131
Total sessions: 1

```

show security flow session interface ge-0/0/2.0 brief

```

root> show security flow session interface ge-7/1/1.0 brief
Flow Sessions on FPC10 PIC1:

Session ID: 410000137, Policy name: default-policy-00/2, Timeout: 2, Valid
  In: 200.0.0.10/5 --> 60.0.0.2/23354;icmp, If: ge-7/1/0.0, Pkts: 1, Bytes: 84, CP Session ID:
410000269
  Out: 60.0.0.2/23354 --> 200.0.0.10/5;icmp, If: ge-7/1/1.0, Pkts: 1, Bytes: 84, CP Session ID:
410000269
Total sessions: 1

Flow Sessions on FPC10 PIC2:

Session ID: 420000151, Policy name: default-policy-00/2, Timeout: 54, Valid
  In: 200.0.0.10/1 --> 60.0.0.2/23354;icmp, If: ge-7/1/0.0, Pkts: 1, Bytes: 84, CP Session ID:
420000252
  Out: 60.0.0.2/23354 --> 200.0.0.10/1;icmp, If: ge-7/1/1.0, Pkts: 0, Bytes: 0, CP Session ID:
420000252
Total sessions: 1

Flow Sessions on FPC10 PIC3:
Total sessions: 0

```

show security flow session interface ge-0/0/2.0 extensive

```

root> show security flow session interface ge-7/1/1.0 extensive
Flow Sessions on FPC10 PIC1:
Total sessions: 0

Flow Sessions on FPC10 PIC2:

Session ID: 420000151, Status: Normal
Flags: 0x40/0x0/0x2000003

```

```

Policy name: default-policy-00/2
Source NAT pool: Null
Dynamic application: junos:UNKNOWN,
Encryption: Unknown
Application traffic control rule-set: INVALID, Rule: INVALID
Maximum timeout: 60, Current timeout: 48
Session State: Valid
Start time: 83328, Duration: 12
  In: 200.0.0.10/1 --> 60.0.0.2/23354;icmp,
    Interface: ge-7/1/0.0,
    Session token: 0x6, Flag: 0xc0000021
    Route: 0xa0010, Gateway: 200.0.0.10, Tunnel: 0
    Port sequence: 0, FIN sequence: 0,
    FIN state: 0,
    Pkts: 1, Bytes: 84
    CP Session ID: 420000252
  Out: 60.0.0.2/23354 --> 200.0.0.10/1;icmp,
    Interface: ge-7/1/1.0,
    Session token: 0x7, Flag: 0xc0000020
    Route: 0x80010, Gateway: 60.0.0.2, Tunnel: 0
    Port sequence: 0, FIN sequence: 0,
    FIN state: 0,
    Pkts: 0, Bytes: 0
    CP Session ID: 420000252
Total sessions: 1

Flow Sessions on FPC10 PIC3:
Total sessions: 0

```

show security flow session interface ge-7/1/1.0 summary

```

root> show security flow session interface ge-7/1/1.0 summary
Flow Sessions on FPC10 PIC1:

Valid sessions: 1
Pending sessions: 0
Invalidated sessions: 0
Sessions in other states: 0
Total sessions: 1

Flow Sessions on FPC10 PIC2:

```



```
Valid sessions: 1
Pending sessions: 0
Invalidated sessions: 0
Sessions in other states: 0
Total sessions: 1
```

```
Flow Sessions on FPC10 PIC3:
```

```
Valid sessions: 2
Pending sessions: 0
Invalidated sessions: 0
Sessions in other states: 0
Total sessions: 2
```

Release Information

Command introduced in Junos OS Release 8.5; Filter and view options added in Junos OS Release 10.2.

RELATED DOCUMENTATION

[Understanding Traffic Processing on Security Devices | 2](#)

[clear security flow session interface | 458](#)

show security flow session nat

IN THIS SECTION

- [Syntax | 714](#)
- [Description | 714](#)
- [Options | 714](#)
- [Required Privilege Level | 714](#)

- [Output Fields | 714](#)
- [Sample Output | 716](#)
- [Release Information | 718](#)

Syntax

```
show security flow session nat [brief | extensive | summary]
```

Description

Display sessions with network address translation.

Options

brief | extensive | summary

Display the specified level of output.

Required Privilege Level

view

Output Fields

[Table 57 on page 715](#) lists the output fields for the `show security flow session nat` command. Output fields are listed in the approximate order in which they appear.

Table 57: show security flow session nat Output Fields

Field Name	Field Description
Session ID	Number that identifies the session. You can use this ID to get additional information about the session.
Policy name	Policy that permitted the traffic.
Timeout	Idle timeout after which the session expires.
Resource information	Information about the session particular to the resource manager, including the name of the ALG, the group ID, and the resource ID.
In	Incoming flow (source and destination IP addresses, application protocol, interface, session token, route, gateway, tunnel, port sequence, FIN sequence, FIN state, packets and bytes).
Out	Reverse flow (source and destination IP addresses, application protocol, interface, session token, route, gateway, tunnel, port sequence, FIN sequence, FIN state, packets and bytes).
Total sessions	Total number of sessions.
Status	Session status.
Flag	Internal flag depicting the state of the session, used for debugging purposes.
Policy name	Name and ID of the policy that the first packet of the session matched.
Source NAT pool	The name of the source pool where NAT is used.
Application	Name of the application.
Maximum timeout	Maximum session timeout.

Table 57: show security flow session nat Output Fields (Continued)

Field Name	Field Description
Current timeout	Remaining time for the session unless traffic exists in the session.
Session State	Session state.
Start time	Time when the session was created, offset from the system start time.
Valid sessions	Number of valid sessions.
Pending sessions	Number of pending sessions.
Invalidated sessions	Number of invalidated sessions.

Sample Output

show security flow session nat brief

```

root> show security flow session nat brief
Flow Sessions on FPC10 PIC1:
Total sessions: 0

Flow Sessions on FPC10 PIC2:

Session ID: 420000390, Policy name: default-policy-00/2, Timeout: 1778, Valid
  In: 200.0.0.10/41043 --> 60.0.0.2/21;tcp, If: ge-7/1/0.0, Pkts: 9, Bytes: 414, CP Session ID:
420001090
  Out: 60.0.0.2/21 --> 60.0.0.1/19473;tcp, If: ge-7/1/1.0, Pkts: 8, Bytes: 479, CP Session ID:
430000964
Total sessions: 1

Flow Sessions on FPC10 PIC3:
Total sessions: 0

```

show security flow session nat extensive

```
root> show security flow session nat extensive
Flow Sessions on FPC10 PIC1:
Total sessions: 0

Flow Sessions on FPC10 PIC2:

Session ID: 420000390, Status: Normal
Flags: 0x2/0x0/0x2010103
Policy name: default-policy-00/2
Source NAT pool: interface, Application: junos-ftp/1
Dynamic application: junos:UNKNOWN,
Encryption: Unknown
Application traffic control rule-set: INVALID, Rule: INVALID
Maximum timeout: 1800, Current timeout: 1770
Session State: Valid
Start time: 151971, Duration: 55
  In: 200.0.0.10/41043 --> 60.0.0.2/21;tcp,
    Interface: ge-7/1/0.0,
    Session token: 0x6, Flag: 0xc0002621
    Route: 0x70010, Gateway: 200.0.0.10, Tunnel: 0
    Port sequence: 0, FIN sequence: 0,
    FIN state: 0,
    Pkts: 9, Bytes: 414
    CP Session ID: 420001090
  Out: 60.0.0.2/21 --> 60.0.0.1/19473;tcp,
    Interface: ge-7/1/1.0,
    Session token: 0x7, Flag: 0xe0002620
    Route: 0x80010, Gateway: 60.0.0.2, Tunnel: 0
    Port sequence: 0, FIN sequence: 0,
    FIN state: 0,
    Pkts: 8, Bytes: 479
    CP Session ID: 430000964
Total sessions: 1

Flow Sessions on FPC10 PIC3:
Total sessions: 0
```

show security flow session nat summary

```
root> show security flow session nat summary
Flow Sessions on FPC10 PIC1:

Valid sessions: 0
Pending sessions: 0
Invalidated sessions: 0
Sessions in other states: 0
Total sessions: 0

Flow Sessions on FPC10 PIC2:

Valid sessions: 1
Pending sessions: 0
Invalidated sessions: 0
Sessions in other states: 0
Total sessions: 1

Flow Sessions on FPC10 PIC3:

Valid sessions: 0
Pending sessions: 0
Invalidated sessions: 0
Sessions in other states: 0
Total sessions: 0
```

Release Information

Command introduced in Junos OS Release 10.2.

RELATED DOCUMENTATION

[Understanding Traffic Processing on Security Devices | 2](#)

[show security flow session | 656](#)

show security flow session plugins

IN THIS SECTION

- [Syntax | 719](#)
- [Description | 719](#)
- [Required Privilege Level | 719](#)
- [Output Fields | 719](#)
- [Sample Output | 721](#)
- [Release Information | 722](#)

Syntax

```
show security flow session plugins
```

Description

Displays the detailed information about security flow session of plugins. The output displays the information in a list to make it easy for you to read and monitor the flow session.

Required Privilege Level

View

Output Fields

[Table 58 on page 720](#) lists the output fields for the `show security flow session plugins` command.

Table 58: show security flow session plugins Output Fields

Field Name	Field Description
Bandwidth	Client to server and server to client bytes added together and converted to MB or GB.
Base Layer7 Application	Base layer7 application details. <ul style="list-style-type: none"> • True: SSL proxy decrypted. • False: SSL proxy not decrypted.
Decrypted	SSL proxy decryption status.
Decrypted-Mirrored	Decryption mirror status.
Duration	Duration of the session.
Final Layer7 Application	The last classified application.
Forwarding Type	Show the type of current flow session.
Forward Direction	Interface, IP address, protocol, tag, and gateway information of this direction.
From Zone	Source zone of the flow session.
Hardware Accelerated	Status of the Express Path flow session.
Layer4 Application	Layer4 applications details.
Plugin List	List of the plugins used in the flow session.
Policy	Policy details.
Reverse Direction	Interface, IP address, protocol, tag, and gateway information of the flowdirection.

Table 58: show security flow session plugins Output Fields (Continued)

Field Name	Field Description
Session ID	Number that identifies the session. Use this ID to get more information about the session.
Session HA Status	Session HA status such as Stand-alone, Forward, Warm, Active, Backup, orUnknown.
Session State	Status of security flow session.
Start time	Time when the session was created, offset from the system start time.
Time Out	Idle time-out after which the session expires.
To Zone	Destination zone of the flow session.
Tunneled Session	Status of the tunnel session. <ul style="list-style-type: none"> • True: Session is a tunnel session. • False: Session is not a tunnel session.

Sample Output

show security flow session plugins

```
user@host> show security flow session plugins
```

```
Session ID           : 19
Forward Direction    : Interface: .local..0, 192.0.2.0/10002 --> 198.51.100.0/80;tcp, conn
tag: 0x0, gateway: 192.0.2.0
Reverse Direction    : Interface: ge-0/0/15.0, 198.51.100.0/80 --> 192.0.2.0/10002;tcp, conn
tag: 0x0, gateway: 203.0.113.0
Forwarding Type      : Route
Bandwidth            : 0.02 MB
```

```

From Zone           : junos-host
To Zone             : internet
Layer4 Application  : junos-http
Base Layer7 Application : UNKNOWN
Final Layer7 Application: UNKNOWN
Hardware Accelerated : False
Decrypted           : False
Decrypted-Mirrored  : False
Tunneled Session    : False
Session State       : Valid
Session HA Status   : Stand-alone
Policy              : self-traffic-policy/1
Time Out            : 300 s
Time-To-Live        : 272 s
Start Time          : 83 s
Duration            : 3811 s
Plugin List:
junos-tcp-svr-emul: C2S Interested, S2C Interested
junos-rtcom-stream: C2S Interested, S2C Interested
junos-tcp-clt-emul: C2S Interested, S2C Interested

```

Release Information

Command introduced in Junos OS Release 21.1R1.

RELATED DOCUMENTATION

| [show security flow session](#) | 656

show security flow session policy-id

IN THIS SECTION

● [Syntax](#) | 723

- [Description | 723](#)
- [Options | 723](#)
- [Required Privilege Level | 723](#)
- [Output Fields | 724](#)
- [Sample Output | 726](#)
- [Release Information | 727](#)

Syntax

```
show security flow session policy-id policy-id-number [brief | extensive | summary ]
```

Description

Display information about each session by using policy id of the session.

Options

- *policy-id-number* —ID of the policy that the first packet of the session matches with.
Range: 1through 4294967295
- brief | extensive | summary—Display the specified level of output.

Required Privilege Level

view

Output Fields

Table 59 on page 724 lists the output fields for the `show security flow session policy-id` command. Output fields are listed in the approximate order in which they appear.

Table 59: show security flow session policy-id Output Fields

Field Name	Field Description
Session ID	Number that identifies the session. You can use this ID to get additional information about the session.
Policy name	Policy that permitted the traffic.
Timeout	Idle timeout after which the session expires.
In	<p>For the input flow:</p> <ul style="list-style-type: none"> • Source and destination addresses and protocol tuple for the input flow. • Interface: Input flow interface. • Session token: Internal token derived from the virtual routing instance. • Flag: Internal debugging flags. • Route: Internal next hop of the route to be used by the flow. • Gateway: Next-hop gateway of the flow. • Tunnel: If the flow is going into a tunnel, the tunnel ID. Otherwise, 0 (zero). • Port Sequence, FIN sequence, FIN state, Cookie: Internal TCP state tracking information.

Table 59: show security flow session policy-id Output Fields (Continued)

Field Name	Field Description
Out	<p>For the reverse flow:</p> <ul style="list-style-type: none"> • Source and destination addresses, and protocol tuple for the reverse flow. • Interface: Reverse flow interface. • Session token: Internal token derived from the virtual routing instance. • Flag: Internal debugging flags. • Route: Internal next hop of the route to be used by the flow. • Gateway: Next-hop gateway of the flow. • Tunnel: If the flow is going into a tunnel, the tunnel ID. Otherwise, 0 (zero). • Port Sequence, FIN sequence, FIN state, Cookie: Internal TCP state tracking information.
Total sessions	Total number of sessions.
Status	Session status.
Flag	Internal flag depicting the state of the session, used for debugging purposes.
Policy name	Name and ID of the policy that the first packet of the session matched.
Source NAT pool	The name of the source pool where NAT is used.
Dynamic application	Name of the application.
Maximum timeout	Maximum session timeout.
Current timeout	Remaining time for the session unless traffic exists in the session.

Table 59: show security flow session policy-id Output Fields (Continued)

Field Name	Field Description
Session State	Session state.
Start time	Time when the session was created, offset from the system start time.

Sample Output

show security flow session policy-id 4

```

root> show security flow session policy-id 4
Flow Sessions on FPC1 PIC0:

Session ID: 20093273, Policy name: p1/4, Timeout: 1784, Valid
  In: 101.0.0.2/1 --> 111.0.0.3/1;0, If: ge-0/0/0.0, Pkts: 1, Bytes: 84
  Out: 111.0.0.3/1 --> 201.0.0.1/22643;0, If: ge-0/0/1.0, Pkts: 0, Bytes: 0
Total sessions: 1

```

show security flow session policy-id 4 extensive

```

root> show security flow session policy-id 4 extensive
Flow Sessions on FPC10 PIC1:
Total sessions: 0

Flow Sessions on FPC10 PIC2:

Session ID: 420000428, Status: Normal
Flags: 0x0/0x0/0x2008003
Policy name: p1/4
Source NAT pool: interface, Application: junos-telnet/10
Dynamic application: junos:UNKNOWN,
Encryption: Unknown
Application traffic control rule-set: INVALID, Rule: INVALID
Maximum timeout: 1800, Current timeout: 1740

```

```
Session State: Valid
Start time: 152305, Duration: 64
  In: 200.0.0.10/15192 --> 60.0.0.2/23;tcp,
    Interface: ge-7/1/0.0,
    Session token: 0x6, Flag: 0xc0001021
    Route: 0x70010, Gateway: 200.0.0.10, Tunnel: 0
    Port sequence: 0, FIN sequence: 0,
    FIN state: 0,
    Pkts: 40, Bytes: 2251
    CP Session ID: 420001128
  Out: 60.0.0.2/23 --> 60.0.0.1/8078;tcp,
    Interface: ge-7/1/1.0,
    Session token: 0x7, Flag: 0xe0001020
    Route: 0x80010, Gateway: 60.0.0.2, Tunnel: 0
    Port sequence: 0, FIN sequence: 0,
    FIN state: 0,
    Pkts: 28, Bytes: 1714
    CP Session ID: 430000965
Total sessions: 1

Flow Sessions on FPC10 PIC3:
Total sessions: 0
```

Release Information

Command introduced in Junos OS Release 12.3X48-D10.

show security flow session pretty

IN THIS SECTION

- [Syntax | 728](#)
- [Description | 728](#)
- [Required Privilege Level | 728](#)

- [Output Fields | 728](#)
- [Sample Output | 731](#)
- [Release Information | 732](#)

Syntax

```
show security flow session pretty
```

Description

Displays the detailed information about security flow session. The output displays the information in a list to make it easy for you to read and monitor the flow session.

Required Privilege Level

View

Output Fields

[Table 60 on page 728](#) lists the output fields for the `show security flow session pretty` command.

Table 60: show security flow session pretty Output Fields

Field Name	Field Description
Advanced Security Feature Status	Status of the advanced security feature status such as Content Security, IDP, Advance Anti-Malware, Security-Intelligence, ICAP-Redirect , and App-Routing.
Bandwidth	Client to server and server to client bytes added together and converted to MB or GB.

Table 60: show security flow session pretty Output Fields (Continued)

Field Name	Field Description
Base Layer7 Application	Base layer7 application details.
Decrypted	SSL proxy decryption status. <ul style="list-style-type: none"> • True: SSL proxy decrypted. • False: SSL proxy not decrypted.
Decrypted-Mirrored	Decryption mirror status.
Destination-User	Destination user details.
Destination-Zone	Flow session destination zone details.
Duration	Duration of the session.
Final Layer7 Application	The last classified application.
Forwarding Type	Show the type of current flow session.
Forward Direction	Interface, IP address, protocol, tag, and gateway information of this direction.
Hardware Accelerated	Status of the Express Path flow session.
Inspection Mode	Flow session inspection mode.
JDPI Classification	JDPI classification status.
Layer4 Application	Layer4 applications details.
LSYS	Logical system details.

Table 60: show security flow session pretty Output Fields (Continued)

Field Name	Field Description
Plugin List	List of the plugins used in the flow session.
Policy	Policy details.
Reverse Direction	Interface, IP address, protocol, tag, and gateway information of the flowdirection.
Session ID	Number that identifies the session. Use this ID to get more information about the session.
Session HA Status	Show the HA status.
Session State	Show the HA status.
Session State	Status of security flow session.
Start time	Time when the session was created, offset from the system start time.
Source-User	Shows the user source address.
Source-Zone	Flow session source zone details.
Time Out	Idle time-out after which the session expires.
TSYS	Tenant system details.
Tunnel Inspection	Tunnel inspection status.
Tunneled Session	Status of the tunnel session. <ul style="list-style-type: none"> • True: Session is a tunnel session. • False: Session is not a tunnel session.

Sample Output

show security flow session pretty

```
user@host> show security flow session pretty
```

```
Session ID           : 438249
Forward Direction    : Interface:ge-0/0/0.1, 192.0.2.0/45750 --> 203.0.113.0/443;tcp,
tag 0x0, Gateway 192.0.2.0
Reverse Direction    : Interface:ge-0/0/2.0, 203.0.113.0/443 -->
198.51.100.04/45750;tcp, tag 0x0, Gateway 198.51.100.0
Forwarding Type      : Route/Nat/Transparent/Secure-Wire/Tap
Session State        : Valid
Session HA Status    : Stand-alone
Start Time           : 350 s
Duration             : 19 s
Timeout              : 1800 s
Time-to-Live         : 1799 s
Bandwidth            : 18MB
Source-User          : example1.com\user123
Destination-User     : Unknown
LSYS                 : LSYS-X
TSYS                 : TSYS-Y
Source-Zone          : Trust
Destination-Zone     : Untrust
Policy               : permit_urls/5
Layer4 Application   : junos:https
Base Layer7 Application : junos:SSL
Final Layer7 Application : junos:CNN
Inspection Mode      : Flow
Hardware Accelerated : False
Decrypted            : False
Decryption-Mirrored  : False
JDPI Classification  : Complete
Tunneled Session     : False
Tunnel Inspection    : N/A
Advanced Security Feature Status:
UTM                  : Flow Mode
IDP                  : Flow Mode
Advance Anti-Malware : Flow Mode
```

Security-Intelligence	: Flow Mode
ICAP-Redirect	: Flow Mode
App-Routing	: Flow Mode

Release Information

Command introduced in Junos OS Release 21.1R1.

RELATED DOCUMENTATION

| [show security flow session | 656](#)

show security flow session protocol

IN THIS SECTION

- [Syntax | 732](#)
- [Description | 733](#)
- [Options | 733](#)
- [Required Privilege Level | 734](#)
- [Output Fields | 734](#)
- [Sample Output | 736](#)
- [Release Information | 739](#)

Syntax

```
show security flow session protocol ( protocol-name | protocol-  
number )  
[brief | extensive | summary]
```

Description

Display information about each session that uses the specified protocol.

Options

protocol-name —(Optional) Protocol to use as a sessions filter. Information about sessions that use this protocol is displayed. Possible protocols are:

- ah—IP Security Authentication Header
- egp—Exterior gateway protocol
- esp—IPsec Encapsulating Security Payload
- gre—Generic routing encapsulation
- icmp—Internet Control Message Protocol
- igmp—Internet Group Management Protocol
- ipip—IP over IP
- ospf—Open Shortest Path First
- pim—Protocol Independent Multicast
- rsvp—Resource Reservation Protocol
- sctp—Stream Control Transmission Protocol
- tcp—Transmission Control Protocol
- udp—User Datagram Protocol

protocol-number —(Optional) Numeric protocol value. For a complete list of possible numeric values, see RFC 1700, *Assigned Numbers (for the Internet Protocol Suite)*.

Range: 0 through 255

brief | extensive | summary

Display the specified level of output.

Required Privilege Level

view

Output Fields

Table 61 on page 734 lists the output fields for the show security flow session protocol command. Output fields are listed in the approximate order in which they appear.

Table 61: show security flow session protocol Output Fields

Field Name	Field Description
Session ID	Number that identifies the session. You can use this ID to get additional information about the session.
Policy name	Policy that permitted the traffic.
Timeout	Idle timeout after which the session expires.
In	Incoming flow (source and destination IP addresses, application protocol, interface, session token, route, gateway, tunnel, port sequence, FIN sequence, FIN state, packets and bytes).
Out	Reverse flow (source and destination IP addresses, application protocol, interface, session token, route, gateway, tunnel, port sequence, FIN sequence, FIN state, packets and bytes).
Total sessions	Total number of sessions.
Status	Session status.
Flag	Internal flag depicting the state of the session, used for debugging purposes.
Policy name	Name and ID of the policy that the first packet of the session matched.

Table 61: show security flow session protocol Output Fields (Continued)

Field Name	Field Description
Source NAT pool	The name of the source pool where NAT is used.
Application	Name of the application.
Maximum timeout	Maximum session timeout.
Current timeout	Remaining time for the session unless traffic exists in the session.
Session State	Session state.
Start time	Time when the session was created, offset from the system start time.
Unicast-sessions	Number of unicast sessions.
Multicast-sessions	Number of multicast sessions.
Failed-sessions	Number of failed sessions.
Sessions-in-use	Number of sessions in use. <ul style="list-style-type: none"> • Valid sessions • Pending sessions • Invalidated sessions • Sessions in other states
Maximum-sessions	Number of maximum sessions.

Sample Output

show security flow session protocol icmp

```
root> show security flow session protocol icmp
Flow Sessions on FPC10 PIC1:

Session ID: 410000654, Policy name: p1/4, Timeout: 2, Valid
  In: 200.0.0.10/2 --> 60.0.0.2/15685;icmp, If: ge-7/1/0.0, Pkts: 1, Bytes: 84, CP Session ID:
410001264
  Out: 60.0.0.2/15685 --> 200.0.0.10/2;icmp, If: ge-7/1/1.0, Pkts: 1, Bytes: 84, CP Session ID:
410001264
Total sessions: 1

Flow Sessions on FPC10 PIC2:
Total sessions: 0

Flow Sessions on FPC10 PIC3:

Session ID: 430000399, Policy name: p1/4, Timeout: 2, Valid
  In: 200.0.0.10/3 --> 60.0.0.2/15685;icmp, If: ge-7/1/0.0, Pkts: 1, Bytes: 84, CP Session ID:
430001053
  Out: 60.0.0.2/15685 --> 200.0.0.10/3;icmp, If: ge-7/1/1.0, Pkts: 1, Bytes: 84, CP Session ID:
430001053
Total sessions: 1
```

show security flow session protocol icmp brief

```
root> show security flow session protocol icmp brief
Flow Sessions on FPC10 PIC1:

Session ID: 410000658, Policy name: p1/4, Timeout: 4, Valid
  In: 200.0.0.10/4 --> 60.0.0.2/16453;icmp, If: ge-7/1/0.0, Pkts: 1, Bytes: 84, CP Session ID:
410001268
  Out: 60.0.0.2/16453 --> 200.0.0.10/4;icmp, If: ge-7/1/1.0, Pkts: 1, Bytes: 84, CP Session ID:
410001268
Total sessions: 1

Flow Sessions on FPC10 PIC2:
```



```

Session ID: 420000612, Policy name: p1/4, Timeout: 2, Valid
  In: 200.0.0.10/5 --> 60.0.0.2/16453;icmp, If: ge-7/1/0.0, Pkts: 1, Bytes: 84, CP Session ID:
420001316
  Out: 60.0.0.2/16453 --> 200.0.0.10/5;icmp, If: ge-7/1/1.0, Pkts: 1, Bytes: 84, CP Session ID:
420001316
Total sessions: 1

```

Flow Sessions on FPC10 PIC3:

```

Session ID: 430000405, Policy name: p1/4, Timeout: 2, Valid
  In: 200.0.0.10/6 --> 60.0.0.2/16453;icmp, If: ge-7/1/0.0, Pkts: 1, Bytes: 84, CP Session ID:
430001059
  Out: 60.0.0.2/16453 --> 200.0.0.10/6;icmp, If: ge-7/1/1.0, Pkts: 1, Bytes: 84, CP Session ID:
430001059
Total sessions: 1

```

show security flow session protocol icmp extensive

```

root> show security flow session protocol icmp extensive
Flow Sessions on FPC10 PIC1:

Session ID: 410000660, Status: Normal
Flags: 0x80000040/0x0/0x2800003
Policy name: p1/4
Source NAT pool: Null
Dynamic application: junos:UNKNOWN,
Encryption: Unknown
Application traffic control rule-set: INVALID, Rule: INVALID
Maximum timeout: 4, Current timeout: 2
Session State: Valid
Start time: 153201, Duration: 3
  In: 200.0.0.10/8 --> 60.0.0.2/16453;icmp,
    Interface: ge-7/1/0.0,
    Session token: 0x6, Flag: 0xc0000021
    Route: 0x70010, Gateway: 200.0.0.10, Tunnel: 0
    Port sequence: 0, FIN sequence: 0,
    FIN state: 0,
    Pkts: 1, Bytes: 84
    CP Session ID: 410001270
  Out: 60.0.0.2/16453 --> 200.0.0.10/8;icmp,
    Interface: ge-7/1/1.0,

```

```
Session token: 0x7, Flag: 0xc0000020
Route: 0x80010, Gateway: 60.0.0.2, Tunnel: 0
Port sequence: 0, FIN sequence: 0,
FIN state: 0,
Pkts: 1, Bytes: 84
CP Session ID: 410001270
Total sessions: 1
```

```
Flow Sessions on FPC10 PIC2:
Total sessions: 0
```

```
Flow Sessions on FPC10 PIC3:
Total sessions: 0
```

show security flow session protocol icmp summary

```
root> show security flow session protocol icmp summary
Flow Sessions on FPC10 PIC1:

Valid sessions: 2
Pending sessions: 0
Invalidated sessions: 1
Sessions in other states: 0
Total sessions: 3

Flow Sessions on FPC10 PIC2:

Valid sessions: 0
Pending sessions: 0
Invalidated sessions: 0
Sessions in other states: 0
Total sessions: 0

Flow Sessions on FPC10 PIC3:

Valid sessions: 2
Pending sessions: 0
Invalidated sessions: 1
Sessions in other states: 0
Total sessions: 3
```

Release Information

Command introduced in Junos OS Release 8.5; Filter and view options introduced in Junos OS Release 10.2.

RELATED DOCUMENTATION

[Understanding Traffic Processing on Security Devices | 2](#)

[clear security flow session protocol | 467](#)

show security flow session resource-manager

IN THIS SECTION

- [Syntax | 739](#)
- [Description | 740](#)
- [Options | 740](#)
- [Required Privilege Level | 740](#)
- [Output Fields | 740](#)
- [Sample Output | 742](#)
- [Release Information | 745](#)

Syntax

```
show security flow session resource-manager  
[brief | extensive | summary]
```

Description

This command displays information about sessions created by the resource manager.

Options

`none`—Display all resource manager sessions.

`brief | extensive | summary` Display the specified level of output.

Required Privilege Level

view

Output Fields

[Table 62 on page 740](#) lists the output fields for the `show security flow session resource-manager` command. Output fields are listed in the approximate order in which they appear.

Table 62: show security flow session resource-manager Output Fields

Field Name	Field Description
Session ID	Number that identifies the session. You can use this ID to get additional information about the session.
Policy name	Policy that permitted the traffic.
Timeout	Idle timeout after which the session expires.
Resource information	Information about the session particular to the resource manager, including the name of the ALG, the group ID, and the resource ID.

Table 62: show security flow session resource-manager Output Fields (Continued)

Field Name	Field Description
In	Incoming flow (source and destination IP addresses, application protocol, interface, session token, route, gateway, tunnel, port sequence, FIN sequence, FIN state, packets and bytes).
Out	Reverse flow (source and destination IP addresses, application protocol, interface, session token, route, gateway, tunnel, port sequence, FIN sequence, FIN state, packets and bytes).
Total sessions	Total number of sessions.
Status	Session status.
Flag	Internal flag depicting the state of the session, used for debugging purposes.
Policy name	Name and ID of the policy that the first packet of the session matched.
Source NAT pool	The name of the source pool where NAT is used.
Application	Name of the application.
Maximum timeout	Maximum session timeout.
Current timeout	Remaining time for the session unless traffic exists in the session.
Session State	Session state.
Start time	Time when the session was created, offset from the system start time.
Valid sessions	Number of valid sessions.
Pending sessions	Number of pending sessions.

Table 62: show security flow session resource-manager Output Fields (Continued)

Field Name	Field Description
Invalidated sessions	Number of invalidated sessions.
Sessions in other states	Number of sessions in other states.
CP Session ID	Number that identifies the central point session. Use this ID to get more information about the central point session.

Sample Output

show security flow session resource-manager

```

root> show security flow session resource-manager
Flow Sessions on FPC10 PIC1:

Session ID: 410000664, Policy name: p1/4, Timeout: 1734, Valid
Resource information : FTP ALG, 1, 0
  In: 200.0.0.10/41047 --> 60.0.0.2/21;tcp, If: ge-7/1/0.0, Pkts: 13, Bytes: 586, CP Session ID:
410001274
  Out: 60.0.0.2/21 --> 200.0.0.10/41047;tcp, If: ge-7/1/1.0, Pkts: 13, Bytes: 803, CP Session
ID: 410001274
Total sessions: 1

Flow Sessions on FPC10 PIC2:
Total sessions: 0

Flow Sessions on FPC10 PIC3:
Total sessions: 0

```

show security flow session resource-manager brief

```

root> show security flow session resource-manager brief
Flow Sessions on FPC10 PIC1:

```

```

Session ID: 410000664, Policy name: p1/4, Timeout: 1704, Valid
Resource information : FTP ALG, 1, 0
  In: 200.0.0.10/41047 --> 60.0.0.2/21;tcp, If: ge-7/1/0.0, Pkts: 13, Bytes: 586, CP Session ID:
410001274
  Out: 60.0.0.2/21 --> 200.0.0.10/41047;tcp, If: ge-7/1/1.0, Pkts: 13, Bytes: 803, CP Session
ID: 410001274
Total sessions: 1

Flow Sessions on FPC10 PIC2:
Total sessions: 0

Flow Sessions on FPC10 PIC3:
Total sessions: 0

```

show security flow session resource-manager extensive

```

root> show security flow session resource-manager extensive
Flow Sessions on FPC10 PIC1:

Session ID: 410000664, Status: Normal
Flags: 0x42/0x0/0x2010103
Policy name: p1/4
Source NAT pool: Null, Application: junos-ftp/1
Dynamic application: junos:UNKNOWN,
Encryption: Unknown
Application traffic control rule-set: INVALID, Rule: INVALID
Maximum timeout: 1800, Current timeout: 1682
Session State: Valid
Start time: 160496, Duration: 153
Client: FTP ALG, Group: 1, Resource: 0
  In: 200.0.0.10/41047 --> 60.0.0.2/21;tcp,
  Interface: ge-7/1/0.0,
  Session token: 0x6, Flag: 0xc0002621
  Route: 0x70010, Gateway: 200.0.0.10, Tunnel: 0
  Port sequence: 0, FIN sequence: 0,
  FIN state: 0,
  Pkts: 13, Bytes: 586
  CP Session ID: 410001274
  Out: 60.0.0.2/21 --> 200.0.0.10/41047;tcp,
  Interface: ge-7/1/1.0,

```

```
Session token: 0x7, Flag: 0xc0002620
Route: 0x80010, Gateway: 60.0.0.2, Tunnel: 0
Port sequence: 0, FIN sequence: 0,
FIN state: 0,
Pkts: 13, Bytes: 803
CP Session ID: 410001274
Total sessions: 1
```

```
Flow Sessions on FPC10 PIC2:
Total sessions: 0
```

```
Flow Sessions on FPC10 PIC3:
Total sessions: 0
```

show security flow session resource-manager summary

```
root> show security flow session resource-manager summary
```

```
Flow Sessions on FPC10 PIC1:
```

```
Valid sessions: 1
Pending sessions: 0
Invalidated sessions: 0
Sessions in other states: 0
Total sessions: 1
```

```
Flow Sessions on FPC10 PIC2:
```

```
Valid sessions: 0
Pending sessions: 0
Invalidated sessions: 0
Sessions in other states: 0
Total sessions: 0
```

```
Flow Sessions on FPC10 PIC3:
```

```
Valid sessions: 0
Pending sessions: 0
Invalidated sessions: 0
Sessions in other states: 0
Total sessions: 0
```

Release Information

Command introduced in Junos OS Release 8.5.

Filter and view options introduced in Junos OS Release 10.2.

RELATED DOCUMENTATION

[Understanding Traffic Processing on Security Devices | 2](#)

[clear security flow session resource-manager | 470](#)

show security flow session services-offload

IN THIS SECTION

- [Syntax | 745](#)
- [Description | 746](#)
- [Options | 746](#)
- [Required Privilege Level | 747](#)
- [Output Fields | 747](#)
- [Sample Output | 749](#)
- [Release Information | 752](#)

Syntax

```
show security flow session services-offload  
[filter] [brief | extensive | summary]
```

Description

Display information about all currently active services-offload security sessions on the device.

Options

- *filter*—Filter the display by the specified criteria.

The following filters reduce the display to those sessions that match the criteria specified by the filter:

<code>application</code>	Application name.
<code>application-firewall-rule-set</code>	Application firewall enabled with the specified rule set.
<code>application-traffic-control-rule-set</code>	Application traffic control enabled with the specified rule set.
<code>destination-port</code>	Destination port.
<code>destination-prefix</code>	Destination IP prefix or address.
<code>dynamic-application</code>	Dynamic application name.
<code>dynamic-application-group</code>	Dynamic application group name.
<code>encrypted</code>	Show encrypted traffic.
<code>family</code>	Protocol family.
<code>interface</code>	Name of incoming or outgoing interface.
<code>logical-system</code>	Logical system name.
<code>protocol</code>	IP protocol number.
<code>root-logical-system</code>	Root logical system name.
<code>source-port</code>	Source port.
<code>source-prefix</code>	Source IP prefix or address.
<code>tenant</code>	Tenant system name.

- brief | extensive | summary—Display the specified level of output.

Required Privilege Level

view

Output Fields

[Table 63 on page 747](#) lists the output fields for the `show security flow session services-offload` command. Output fields are listed in the approximate order in which they appear.

Table 63: show security flow session services-offload Output Fields

Field Name	Field Description
Session ID	Number that identifies the services-offload session. Use this ID to get more information about the session.
Policy name	Policy that permits the services-offload traffic.
Timeout	Idle timeout period after which the services-offload session expires.
In	Incoming flow (source and destination IP addresses, application protocol, interface, session token, route, gateway, tunnel, port sequence, FIN sequence, FIN state, packets, and bytes).
Out	Reverse flow (source and destination IP addresses, application protocol, interface, session token, route, gateway, tunnel, port sequence, FIN sequence, FIN state, packets, and bytes).
Total sessions	Total number of services-offload sessions.
Status	Services-offload session status.

Table 63: show security flow session services-offload Output Fields (Continued)

Field Name	Field Description
Flag	Internal flag depicting the state of the services-offload session, used for debugging purposes.
Policy name	Name and ID of the policy that the first packet of the services-offload session matched.
Source NAT pool	The name of the source pool where NAT is used.
Application	Name of the application.
Dynamic application	Name of the dynamic application.
Maximum timeout	Maximum amount of idle time allowed for the services-offload session.
Current timeout	Number of seconds that the current services-offload session has been idle.
Session State	Services-offload session state.
Start time	Time when the services-offload session was created, offset from the system start time.
Duration	Duration of the services-offload session.
Valid sessions	Number of valid services-offload sessions.
Pending sessions	Number of pending services-offload sessions.
Invalidated sessions	Number of invalidated services-offload sessions.
Sessions in other states	Number of services-offload sessions in other states.

Table 63: show security flow session services-offload Output Fields (Continued)

Field Name	Field Description
Total sessions	Total number of services-offload sessions.

Sample Output

show security flow session services-offload

```

user@host>show security flow session services-offload
Flow Sessions on FPC10 PIC1:
Total sessions: 0

Flow Sessions on FPC10 PIC2:

Session ID: 420000002, Policy name: p1/4, Timeout: 1788, Valid
  In: 200.0.0.10/15198 --> 60.0.0.2/23;tcp, If: ge-7/1/0.0, Pkts: 9, Bytes: 507, CP Session ID:
420000002
  Out: 60.0.0.2/23 --> 200.0.0.10/15198;tcp, If: ge-7/1/1.0, Pkts: 8, Bytes: 462, CP Session ID:
420000002
Total sessions: 1

Flow Sessions on FPC10 PIC3:
Total sessions: 0

```

show security flow session services-offload brief

```

user@host>show security flow session services-offload brief
Flow Sessions on FPC10 PIC1:
Total sessions: 0

Flow Sessions on FPC10 PIC2:

Session ID: 420000002, Policy name: p1/4, Timeout: 1748, Valid
  In: 200.0.0.10/15198 --> 60.0.0.2/23;tcp, If: ge-7/1/0.0, Pkts: 9, Bytes: 507, CP Session ID:

```

```

420000002
  Out: 60.0.0.2/23 --> 200.0.0.10/15198;tcp, If: ge-7/1/1.0, Pkts: 8, Bytes: 462, CP Session ID:
420000002
Total sessions: 1

Flow Sessions on FPC10 PIC3:
Total sessions: 0

```

show security flow session services-offload extensive

```

user@host>show security flow session services-offload extensive
Flow Sessions on FPC10 PIC1:
Total sessions: 0

Flow Sessions on FPC10 PIC2:

Session ID: 420000002, Status: Normal
Flags: 0x40/0x0/0x2408003, services-offload
Policy name: p1/4
Source NAT pool: Null, Application: junos-telnet/10
Dynamic application: junos:UNKNOWN,
Encryption: Unknown
Application traffic control rule-set: INVALID, Rule: INVALID
Maximum timeout: 1800, Current timeout: 1718
Session State: Valid
Start time: 165, Duration: 89
  In: 200.0.0.10/15198 --> 60.0.0.2/23;tcp,
    Interface: ge-7/1/0.0,
    Session token: 0x6, Flag: 0x42001021
    Route: 0x80010, Gateway: 200.0.0.10, Tunnel: 0
    Port sequence: 0, FIN sequence: 0,
    FIN state: 0,
    Pkts: 9, Bytes: 507
    CP Session ID: 420000002
  Out: 60.0.0.2/23 --> 200.0.0.10/15198;tcp,
    Interface: ge-7/1/1.0,
    Session token: 0x7, Flag: 0x42001020
    Route: 0x70010, Gateway: 60.0.0.2, Tunnel: 0
    Port sequence: 0, FIN sequence: 0,
    FIN state: 0,
    Pkts: 8, Bytes: 462

```

```
CP Session ID: 420000002
Total sessions: 1

Flow Sessions on FPC10 PIC3:
Total sessions: 0
```

show security flow session services-offload summary

```
user@host>show security flow session services-offload summary
Flow Sessions on FPC10 PIC1:

Valid sessions: 0
Pending sessions: 0
Invalidated sessions: 0
Sessions in other states: 0
Total sessions: 0

Flow Sessions on FPC10 PIC2:

Valid sessions: 0
Pending sessions: 0
Invalidated sessions: 0
Sessions in other states: 0
Total sessions: 0

Flow Sessions on FPC10 PIC3:

Valid sessions: 1
Pending sessions: 0
Invalidated sessions: 0
Sessions in other states: 0
Total sessions: 1
```

show security flow session services-offload summary logical-system LSYS1

```
user@host>show security flow session services-offload summary logical-system LSYS1
Valid sessions: 500
    Pending sessions: 0
    Invalidated sessions: 0
```

```
Sessions in other states: 0  
Total sessions: 500
```

show security flow session services-offload summary

```
user@host:LSYS1>show security flow session services-offload summary  
Valid sessions: 500  
    Pending sessions: 0  
    Invalidated sessions: 0  
    Sessions in other states: 0  
    Total sessions: 500
```

show security flow session services-offload summary tenant TSYS1

```
user@host>show security flow session services-offload summary tenant TSYS1  
Valid sessions: 10  
    Pending sessions: 0  
    Invalidated sessions: 0  
    Sessions in other states: 0  
    Total sessions: 10
```

show security flow session services-offload summary

```
user@host:TSYS1>show security flow session services-offload summary  
Valid sessions: 10  
    Pending sessions: 0  
    Invalidated sessions: 0  
    Sessions in other states: 0  
    Total sessions: 10
```

Release Information

Command introduced in Junos OS Release 11.4.

Low-latency option introduced in Junos OS Release 12.1X44-D10.

Starting in Junos OS Release 15.1X49-D10 and Junos OS Release 17.3R1, the SRX5K-MPC3-100G10G (IOC3) and the SRX5K-MPC3-40G10G (IOC3) with Express Path (formerly known as *services offloading*) support are introduced for SRX5400, SRX5600, and SRX5800 Series devices.

Support added on SRX5800, SRX5600, SRX5400 Series devices and vSRX Virtual Firewall.

Support added on SRX4600 Series device in Junos OS Release 20.1R1.

Support added at the logical system and tenant system level in Junos OS Release 20.1R1.

RELATED DOCUMENTATION

[Understanding Traffic Processing on Security Devices | 2](#)

[clear security flow session services-offload | 473](#)

show security flow session session-identifier

IN THIS SECTION

- [Syntax | 753](#)
- [Description | 754](#)
- [Options | 754](#)
- [Required Privilege Level | 754](#)
- [Output Fields | 754](#)
- [Sample Output | 759](#)
- [Release Information | 760](#)

Syntax

```
show security flow session session-identifier session-identifier
```

Description

Display detailed information for the identified session.

Options

session-identifier —Identifier of the session about which to display information.

Required Privilege Level

view

Output Fields

[Table 64 on page 754](#) lists the output fields for the `show security flow session session-identifier` command. Output fields are listed in the approximate order in which they appear.

Table 64: show security flow session session-identifier Output Fields

Field Name	Field Description
Session ID	A unique number that a server assigns a specific user for the duration of that session.
Flags	<p>Internal flag depicting the state of the session, used for debugging purposes. It is internal. The three available flags are:</p> <p>Flags: 0x42/0x0/0x1/0x8103</p> <ul style="list-style-type: none"> • natflag: • natflag2: • natflag3: • flag:

Table 64: show security flow session session-identifier Output Fields (Continued)

Field Name	Field Description
Policy name	<p>Name and ID of the policy that the first packet of the session matched and that permitted the traffic.</p> <p>Session log entries are tied to policy configuration. Each main session event—create, close, and deny—creates a log entry if the controlling policy has enabled logging.</p>
Source NAT pool	<p>The name of the source pool where NAT is used.</p> <p>A NAT pool is a user-defined set of IP addresses that are used for translation. Unlike static NAT, where there is a one-to-one mapping that includes destination IP address translation in one direction and source IP address translation in the reverse direction, with source NAT, the original source IP address is translated to an IP address in the address pool.</p> <p>Source NAT is used to allow hosts with private IP addresses to access a public network.</p>
Dynamic application	<p>Dynamic application: INCONCLUSIVE.</p> <p>If the dynamic application has yet to be determined, the output indicates Pending. If the dynamic application cannot be determined, the output indicates junos: UNKNOWN.</p> <p>Traffic with an application ID of junos: UNKNOWN matches a dynamic application of junos: UNKNOWN. If there is no such rule defined, the default rule is applied.</p> <p>The term junos: UNKNOWN is a reserved keyword.</p>
Encryption	<p>Type of encryption, if the application traffic is encrypted.</p> <p>Encryption: Unknown.</p>
Application traffic control rule-set	<p>Name of the application traffic control rule set.</p> <p>Application traffic control rule-set: INVALID.</p>
Maximum timeout	<p>Maximum session timeout, in seconds.</p>

Table 64: show security flow session session-identifier Output Fields (Continued)

Field Name	Field Description
Session state	Session state: Valid.
Start time	Time, in seconds, when the session was created, offset from the system start time.
In	<p>For the input flow:</p> <ul style="list-style-type: none"> • Source and destination addresses, ports, and protocol tuple for the input flow. • Interface: Input flow interface. • Session token: Internal token derived from the virtual routing instance. • Flag: Internal debugging flags. • Route: Internal next hop of the route to be used by the flow. • Gateway: Next-hop gateway of the flow. • Tunnel: Used for internal debugging. If the flow is going into a tunnel, the decimal format of the tunnel ID, plus the tunnel type. Otherwise, 0 (zero). See Table 65 on page 758 for tunnel type identification. • Port Sequence, FIN sequence, FIN state, Cookie: Internal TCP state tracking information. • Pkts, Bytes, CP Session ID: Packets and bytes matched on the wing, and the associated CP session ID of the wing. • Conn tag: Session connection tag for GRPS tunneling protocol, user plane (GTP-U) flow sessions and Stream Control Transmission Protocol (SCTP) flow sessions.

Table 64: show security flow session session-identifier Output Fields (Continued)

Field Name	Field Description
Out	<p>For the reverse flow:</p> <ul style="list-style-type: none"> • Source and destination IP addresses, and application protocol for the reverse flow. • Interface: Reverse flow interface. • Session token: Internal token derived from the virtual routing instance. • Flag: Internal debugging flags. • Route: Internal next hop of the route to be used by the flow. • Gateway: Next-hop gateway of the flow. • Tunnel: Tunnel type identifier. Used for internal debugging. <p>If the flow is going into a tunnel, species the decimal format of the tunnel ID, plus the tunnel type. Otherwise, 0 (zero). See Table 65 on page 758 for tunnel type identification.</p> <ul style="list-style-type: none"> • Port Sequence, FIN sequence, FIN state, Cookie: Internal TCP state tracking information. • Pkts, Bytes, CP Session ID: Packets and bytes matched on the wing, and the associated CP session ID of the wing. • Conn tag: Session connection tag for GRPS tunneling protocol, user plane (GTP-U) flow sessions and Stream Control Transmission Protocol (SCTP) flow sessions.
Status	<p>Session status:</p> <ul style="list-style-type: none"> • Auth (NAT flag with NAT_AUTH) • Transparent (NAT flag with NAT_TRANSPARENT) • Expired (NAT flag with NAT_INVALID) • Normal (no flag)
Virtual system	Virtual system to which the session belongs (it is optional).

Table 64: show security flow session session-identifier Output Fields (Continued)

Field Name	Field Description
Application	Application match for applying the rule. Application: junos-http/6.
Rule	Name of the application traffic control rule. Rule: INVALID.
Current timeout	Remaining time for the session unless traffic exists in the session.
Duration	Length of time, in seconds, for which the session is active.
Client	Name of the ALG, if there is resource manager.
Group	Group identification number, if there is resource manager.
Resource	Resource identification number, if there is resource manager.

Table 65: Tunnel Type Identification

Binary (first 3 bits)	Hexadecimal (the first 4 bits)	Tunnel Type
0x000	0x0	no tunnel
0x001	0x2	TUNNEL_TYPE_IPSEC
0x010	0x4	TUNNEL_TYPE_L2TP
0x011	0x6	TUNNEL_TYPE_NATT
0x100	0x8	TUNNEL_TYPE_DS_LITE

Table 65: Tunnel Type Identification (Continued)

Binary (first 3 bits)	Hexadecimal (the first 4 bits)	Tunnel Type
0x101	Oxa	TUNNEL_TYPE_MCNH

Sample Output

show security flow session session-identifier 20595

```

root> show security flow session session-identifier 20595
Flow Sessions on FPC10 PIC2:

Session ID: 20595, Status: Normal
Flags: 0x42/0x0/0x1/0x8103
Policy name: pre-id-default-policy-logical-system-00/3
Source NAT pool: Null, Application: junos-http/6
Dynamic application: INCONCLUSIVE,
Encryption: Unknown
Application traffic control rule-set: INVALID, Rule: INVALID
Maximum timeout: 1800, Current timeout: 1788
Session State: Valid
Start time: 247736, Duration: 14
  In: 4.0.0.1/47931 --> 5.0.0.2/80;tcp,
    Conn Tag: 0x0, Interface: ge-0/0/2.0,
    Session token: 0x7, Flag: 0x3621
    Route: 0xe0010, Gateway: 4.0.0.1, Tunnel: 0
    Port sequence: 0, FIN sequence: 0,
    FIN state: 0,
    Pkts: 3, Bytes: 176
  Out: 5.0.0.2/80 --> 4.0.0.1/47931;tcp,
    Conn Tag: 0x0, Interface: ge-0/0/3.0,
    Session token: 0x8, Flag: 0x3620
    Route: 0xc0010, Gateway: 5.0.0.2, Tunnel: 0
    Port sequence: 0, FIN sequence: 0,
    FIN state: 0,

```

Pkts: 2, Bytes: 120
Total sessions: 1

Release Information

Command introduced in Junos OS Release 8.5. Output changed to support natflag2 and flag in Junos OS Release 12.3X48-D10.

RELATED DOCUMENTATION

[Understanding Traffic Processing on Security Devices | 2](#)

[clear security flow session session-identifier | 477](#)

show security flow session source-port

IN THIS SECTION

- [Syntax | 761](#)
- [Description | 761](#)
- [Options | 761](#)
- [Required Privilege Level | 761](#)
- [Output Fields | 761](#)
- [Sample Output | 763](#)
- [Release Information | 766](#)

Syntax

```
show security flow session source-port
source-port-number
[brief | extensive | summary]
```

Description

Display information about each session that uses the specified source port.

Options

- *source-port-number* —Number of the source port about which to display sessions information.
- *brief | extensive | summary*—Display the specified level of output.

Required Privilege Level

view

Output Fields

[Table 66 on page 761](#) lists the output fields for the `show security flow session source-port` command. Output fields are listed in the approximate order in which they appear.

Table 66: show security flow session source-port Output Fields

Field Name	Field Description
Session ID	Number that identifies the session. You can use this ID to get additional information about the session.

Table 66: show security flow session source-port Output Fields (Continued)

Field Name	Field Description
Policy name	Policy that permitted the traffic.
Timeout	Idle timeout after which the session expires.
Resource information	Information about the session particular to the resource manager, including the name of the ALG, the group ID, and the resource ID.
In	Incoming flow (source and destination IP addresses, application protocol, interface, session token, route, gateway, tunnel, port sequence, FIN sequence, FIN state, packets and bytes).
Out	Reverse flow (source and destination IP addresses, application protocol, interface, session token, route, gateway, tunnel, port sequence, FIN sequence, FIN state, packets and bytes).
Total sessions	Total number of sessions.
Status	Session status.
Flag	Internal flag depicting the state of the session, used for debugging purposes.
Policy name	Name and ID of the policy that the first packet of the session matched.
Source NAT pool	The name of the source pool where NAT is used.
Application	Name of the application.
Maximum timeout	Maximum session timeout.
Current timeout	Remaining time for the session unless traffic exists in the session.

Table 66: show security flow session source-port Output Fields (Continued)

Field Name	Field Description
Session State	Session state.
Start time	Time when the session was created, offset from the system start time.
Valid sessions	Number of valid sessions.
Pending sessions	Number of pending sessions.
Invalidated sessions	Number of invalidated sessions.
Sessions in other states	Number of sessions in other states.

Sample Output

show security flow session source-port 15198

```

root> show security flow session source-port 15198
Flow Sessions on FPC10 PIC1:
Total sessions: 0

Flow Sessions on FPC10 PIC2:

Session ID: 420000002, Policy name: p1/4, Timeout: 770, Valid
  In: 200.0.0.10/15198 --> 60.0.0.2/23;tcp, If: ge-7/1/0.0, Pkts: 9, Bytes: 507, CP Session ID:
420000002
  Out: 60.0.0.2/23 --> 200.0.0.10/15198;tcp, If: ge-7/1/1.0, Pkts: 8, Bytes: 462, CP Session ID:
420000002
Total sessions: 1

Flow Sessions on FPC10 PIC3:
Total sessions: 0

```

show security flow session source-port 15198 brief

```
root> show security flow session source-port 15198 brief
Flow Sessions on FPC10 PIC1:
Total sessions: 0

Flow Sessions on FPC10 PIC2:

Session ID: 420000002, Policy name: p1/4, Timeout: 740, Valid
  In: 200.0.0.10/15198 --> 60.0.0.2/23;tcp, If: ge-7/1/0.0, Pkts: 9, Bytes: 507, CP Session ID:
420000002
  Out: 60.0.0.2/23 --> 200.0.0.10/15198;tcp, If: ge-7/1/1.0, Pkts: 8, Bytes: 462, CP Session ID:
420000002
Total sessions: 1

Flow Sessions on FPC10 PIC3:
Total sessions: 0
```

show security flow session source-port 15198 extensive

```
root> show security flow session source-port 15198 extensive
Flow Sessions on FPC10 PIC1:
Total sessions: 0

Flow Sessions on FPC10 PIC2:

Session ID: 420000002, Status: Normal
Flags: 0x40/0x0/0x2408003, services-offload
Policy name: p1/4
Source NAT pool: Null, Application: junos-telnet/10
Dynamic application: junos:UNKNOWN,
Encryption: Unknown
Application traffic control rule-set: INVALID, Rule: INVALID
Maximum timeout: 1800, Current timeout: 750
Session State: Valid
Start time: 165, Duration: 1056
  In: 200.0.0.10/15198 --> 60.0.0.2/23;tcp,
  Interface: ge-7/1/0.0,
  Session token: 0x6, Flag: 0x42001021
  Route: 0x80010, Gateway: 200.0.0.10, Tunnel: 0
```

```
Port sequence: 0, FIN sequence: 0,  
FIN state: 0,  
Pkts: 9, Bytes: 507  
CP Session ID: 42000002  
Out: 60.0.0.2/23 --> 200.0.0.10/15198;tcp,  
Interface: ge-7/1/1.0,  
Session token: 0x7, Flag: 0x42001020  
Route: 0x70010, Gateway: 60.0.0.2, Tunnel: 0  
Port sequence: 0, FIN sequence: 0,  
FIN state: 0,  
Pkts: 8, Bytes: 462  
CP Session ID: 42000002  
Total sessions: 1  
  
Flow Sessions on FPC10 PIC3:  
Total sessions: 0
```

show security flow session source-port 15198 summary

```
root> show security flow session source-port 15198 summary  
Flow Sessions on FPC10 PIC1:  
  
Valid sessions: 0  
Pending sessions: 0  
Invalidated sessions: 0  
Sessions in other states: 0  
Total sessions: 0  
  
Flow Sessions on FPC10 PIC2:  
  
Valid sessions: 1  
Pending sessions: 0  
Invalidated sessions: 0  
Sessions in other states: 0  
Total sessions: 1  
  
Flow Sessions on FPC10 PIC3:  
  
Valid sessions: 0  
Pending sessions: 0  
Invalidated sessions: 0
```

Sessions in other states: 0

Total sessions: 0

Release Information

Command introduced in Junos OS Release 8.5; Filter and view options introduced in Junos OS Release 10.2.

RELATED DOCUMENTATION

[Understanding Traffic Processing on Security Devices | 2](#)

[clear security flow session source-port | 480](#)

show security flow session source-prefix

IN THIS SECTION

- [Syntax | 767](#)
- [Description | 767](#)
- [Options | 767](#)
- [Required Privilege Level | 767](#)
- [Output Fields | 767](#)
- [Sample Output | 769](#)
- [Release Information | 772](#)

Syntax

```
show security flow session source-prefix  
    source-prefix-number  
[brief | extensive | summary]
```

Description

Display information about each session that uses the specified source prefix.

Options

source-prefix-number—Source IP prefix or address for which to display sessions information.

brief | extensive | summary Display the specified level of output.

Required Privilege Level

view

Output Fields

[Table 67 on page 768](#) lists the output fields for the `show security flow session source-prefix` command. Output fields are listed in the approximate order in which they appear.

Table 67: show security flow session source-prefix Output Fields

Field Name	Field Description
Session ID	Number that identifies the session. You can use this ID to get additional information about the session.
Policy name	Policy that permitted the traffic.
Timeout	Idle timeout after which the session expires.
In	Incoming flow (source and destination IP addresses, application protocol, interface, session token, route, gateway, tunnel, port sequence, FIN sequence, FIN state, packets and bytes).
Out	Reverse flow (source and destination IP addresses, application protocol, interface, session token, route, gateway, tunnel, port sequence, FIN sequence, FIN state, packets and bytes).
Total sessions	Total number of sessions.
Status	Session status.
Flag	Internal flag depicting the state of the session, used for debugging purposes.
Policy name	Name and ID of the policy that the first packet of the session matched.
Source NAT pool	The name of the source pool where NAT is used.
Application	Name of the application.
Maximum timeout	Maximum session timeout.
Current timeout	Remaining time for the session unless traffic exists in the session.

Table 67: show security flow session source-prefix Output Fields (Continued)

Field Name	Field Description
Session State	Session state.
Start time	Time when the session was created, offset from the system start time.
Valid sessions	Number of valid sessions.
Pending sessions	Number of pending sessions.
Invalidated sessions	Number of invalidated sessions.
Sessions in other states	Number of sessions in other states.

Sample Output

show security flow session source-prefix 200.0.0.10

```

root> show security flow session source-prefix 200.0.0.10
Flow Sessions on FPC10 PIC1:
Total sessions: 0

Flow Sessions on FPC10 PIC2:

Session ID: 420000002, Policy name: p1/4, Timeout: 488, Valid
  In: 200.0.0.10/15198 --> 60.0.0.2/23;tcp, If: ge-7/1/0.0, Pkts: 9, Bytes: 507, CP Session ID:
420000002
  Out: 60.0.0.2/23 --> 200.0.0.10/15198;tcp, If: ge-7/1/1.0, Pkts: 8, Bytes: 462, CP Session ID:
420000002
Total sessions: 1

Flow Sessions on FPC10 PIC3:
Total sessions: 0

```

show security flow session source-prefix 200.0.0.10 brief

```
root> show security flow session source-prefix 200.0.0.10 brief
Flow Sessions on FPC10 PIC1:
Total sessions: 0

Flow Sessions on FPC10 PIC2:

Session ID: 420000002, Policy name: p1/4, Timeout: 482, Valid
  In: 200.0.0.10/15198 --> 60.0.0.2/23;tcp, If: ge-7/1/0.0, Pkts: 9, Bytes: 507, CP Session ID:
420000002
  Out: 60.0.0.2/23 --> 200.0.0.10/15198;tcp, If: ge-7/1/1.0, Pkts: 8, Bytes: 462, CP Session ID:
420000002
Total sessions: 1

Flow Sessions on FPC10 PIC3:
Total sessions: 0
```

show security flow session source-prefix 200.0.0.10 extensive

```
root> show security flow session source-prefix 200.0.0.10 extensive
Flow Sessions on FPC10 PIC1:
Total sessions: 0

Flow Sessions on FPC10 PIC2:

Session ID: 420000002, Status: Normal
Flags: 0x40/0x0/0x2408003, services-offload
Policy name: p1/4
Source NAT pool: Null, Application: junos-telnet/10
Dynamic application: junos:UNKNOWN,
Encryption: Unknown
Application traffic control rule-set: INVALID, Rule: INVALID
Maximum timeout: 1800, Current timeout: 436
Session State: Valid
Start time: 165, Duration: 1370
  In: 200.0.0.10/15198 --> 60.0.0.2/23;tcp,
  Interface: ge-7/1/0.0,
  Session token: 0x6, Flag: 0x42001021
  Route: 0x80010, Gateway: 200.0.0.10, Tunnel: 0
```

```

Port sequence: 0, FIN sequence: 0,
FIN state: 0,
Pkts: 9, Bytes: 507
CP Session ID: 42000002
Out: 60.0.0.2/23 --> 200.0.0.10/15198;tcp,
Interface: ge-7/1/1.0,
Session token: 0x7, Flag: 0x42001020
Route: 0x70010, Gateway: 60.0.0.2, Tunnel: 0
Port sequence: 0, FIN sequence: 0,
FIN state: 0,
Pkts: 8, Bytes: 462
CP Session ID: 42000002
Total sessions: 1

Flow Sessions on FPC10 PIC3:
Total sessions: 0

```

show security flow session source-prefix 200.0.0.10 summary

```

root> show security flow session source-prefix 200.0.0.10 summary
Flow Sessions on FPC10 PIC1:

Valid sessions: 0
Pending sessions: 0
Invalidated sessions: 0
Sessions in other states: 0
Total sessions: 0

Flow Sessions on FPC10 PIC2:

Valid sessions: 1
Pending sessions: 0
Invalidated sessions: 0
Sessions in other states: 0
Total sessions: 1

Flow Sessions on FPC10 PIC3:

Valid sessions: 0
Pending sessions: 0
Invalidated sessions: 0

```

Sessions in other states: 0

Total sessions: 0

Release Information

Command introduced in Junos OS Release 8.5.

Support for IPv6 addresses added in Junos OS Release 10.2. Support for IPv6 addresses in active/active chassis cluster configurations (in addition to the existing support of active/passive chassis cluster configurations) added in Junos OS Release 10.4.

Filter and view options introduced in Junos OS Release 10.2.

RELATED DOCUMENTATION

[Understanding Traffic Processing on Security Devices | 2](#)

[clear security flow session source-prefix | 482](#)

show security flow session summary family

IN THIS SECTION

- [Syntax | 773](#)
- [Description | 773](#)
- [Options | 773](#)
- [Required Privilege Level | 773](#)
- [Output Fields | 773](#)
- [Sample Output | 774](#)
- [Release Information | 775](#)

Syntax

```
show security flow session summary family (inet | inet6)
```

Description

Display filtered summary of information about existing sessions, including types of sessions, active and failed sessions, and the maximum allowed number of sessions.

Options

- `inet`—Display details summary of IPv4 sessions.
- `inet6`—Display details summary of IPv6 sessions.

Required Privilege Level

view

Output Fields

[Table 68 on page 773](#) lists the output fields for the `show security flow session summary family` command. Output fields are listed in the approximate order in which they appear.

Table 68: show security flow session summary Output Fields

Field Name	Field Description
Valid sessions	Count of valid sessions.

Table 68: show security flow session summary Output Fields (Continued)

Field Name	Field Description
Pending sessions	Count of pending sessions.
Invalidated sessions	Count of sessions the security device has determined to be invalid.
Sessions in other states	Count of sessions not in valid, pending, or invalidated state.
Total sessions	Total of the above counts.

Sample Output

show security flow session summary family inet

```
user@host> show security flow session summary family inet
```

```
Flow Sessions on FPC10 PIC1:
```

```
Valid sessions: 0
```

```
Pending sessions: 0
```

```
Invalidated sessions: 0
```

```
Sessions in other states: 0
```

```
Total sessions: 0
```

```
Flow Sessions on FPC10 PIC2:
```

```
Valid sessions: 1
```

```
Pending sessions: 0
```

```
Invalidated sessions: 0
```

```
Sessions in other states: 0
```

```
Total sessions: 1
```

```
Flow Sessions on FPC10 PIC3:
```

```
Valid sessions: 0
```

```
Pending sessions: 0  
Invalidated sessions: 0  
Sessions in other states: 0  
Total sessions: 0
```

show security flow session summary family inet6

```
user@host> show security flow session summary family inet6  
Flow Sessions on FPC10 PIC1:  
  
Valid sessions: 0  
Pending sessions: 0  
Invalidated sessions: 0  
Sessions in other states: 0  
Total sessions: 0  
  
Flow Sessions on FPC10 PIC2:  
  
Valid sessions: 0  
Pending sessions: 0  
Invalidated sessions: 0  
Sessions in other states: 0  
Total sessions: 0  
  
Flow Sessions on FPC10 PIC3:  
  
Valid sessions: 1  
Pending sessions: 0  
Invalidated sessions: 0  
Sessions in other states: 0  
Total sessions: 1
```

Release Information

Command introduced in Junos OS Release 10.2.

Support on SRX Series Firewalls for flow-based mode for family inet6 added in Junos OS Release 10.2.

Support for IPv6 addresses in active/active chassis cluster configurations (in addition to the existing support of active/passive chassis cluster configurations) added in Junos OS Release 10.4.

RELATED DOCUMENTATION

[Understanding Traffic Processing on Security Devices | 2](#)

[clear security flow session all | 437](#)

show security flow session summary node

IN THIS SECTION

- [Syntax | 776](#)
- [Description | 776](#)
- [Options | 777](#)
- [Required Privilege Level | 777](#)
- [Output Fields | 777](#)
- [Sample Output | 778](#)
- [Release Information | 784](#)

Syntax

```
show security flow session summary node (node-id | all | local | primary)
```

Description

Display information about all currently active security sessions on the device for the specified node options in summary mode.

Options

`node`—(Optional) For chassis cluster configurations, display session information on a specific node.

- `node-id`—Identification number of the node. It can be 0 or 1.
- `all`—Display information about all nodes.
- `local`—Display information about the local node.
- `primary`—Display information about the primary node.

Required Privilege Level

view

Output Fields

[Table 69 on page 777](#) lists the output fields for the `show security flow session summary node` command. Output fields are listed in the approximate order in which they appear.

Table 69: show security flow session summary node Output Fields

Field Name	Field Description
Unicast-sessions	Number of unicast sessions.
Multicast-sessions	Number of multicast sessions.
Failed-sessions	Number of failed sessions.

Table 69: show security flow session summary node Output Fields (Continued)

Field Name	Field Description
Sessions-in-use	Number of sessions in use. <ul style="list-style-type: none"> • Valid sessions • Pending sessions • Invalidated sessions • Sessions in other states
Maximum-sessions	Maximum number of sessions permitted.

Sample Output

show security flow session summary node 0

```
root@host> show security flow session summary node 0
```

```
node0:
```

```
-----
```

```
Flow Sessions on FPC0 PIC1:
```

```
Unicast-sessions: 1
```

```
Multicast-sessions: 0
```

```
Services-offload-sessions: 0
```

```
Failed-sessions: 0
```

```
Sessions-in-use: 1
```

```
  Valid sessions: 1
```

```
  Pending sessions: 0
```

```
  Invalidated sessions: 0
```

```
  Sessions in other states: 0
```

```
Maximum-sessions: 6291456
```

```
Flow Sessions on FPC0 PIC2:
```

```
Unicast-sessions: 0
```

```
Multicast-sessions: 0
```

```
Services-offload-sessions: 0
Failed-sessions: 0
Sessions-in-use: 0
  Valid sessions: 0
  Pending sessions: 0
  Invalidated sessions: 0
  Sessions in other states: 0
Maximum-sessions: 6291456
```

```
Flow Sessions on FPC0 PIC3:
Unicast-sessions: 0
Multicast-sessions: 0
Services-offload-sessions: 0
Failed-sessions: 0
Sessions-in-use: 0
  Valid sessions: 0
  Pending sessions: 0
  Invalidated sessions: 0
  Sessions in other states: 0
Maximum-sessions: 6291456
```

show security flow session summary node 1

```
root@host> show security flow session summary node 1
node1:
```

```
-----

Flow Sessions on FPC0 PIC1:
Unicast-sessions: 1
Multicast-sessions: 0
Services-offload-sessions: 0
Failed-sessions: 0
Sessions-in-use: 1
  Valid sessions: 1
  Pending sessions: 0
  Invalidated sessions: 0
  Sessions in other states: 0
Maximum-sessions: 6291456
```

```
Flow Sessions on FPC0 PIC2:
Unicast-sessions: 0
```

```

Multicast-sessions: 0
Services-offload-sessions: 0
Failed-sessions: 0
Sessions-in-use: 0
  Valid sessions: 0
  Pending sessions: 0
  Invalidated sessions: 0
  Sessions in other states: 0
Maximum-sessions: 6291456

```

```

Flow Sessions on FPC0 PIC3:
Unicast-sessions: 0
Multicast-sessions: 0
Services-offload-sessions: 0
Failed-sessions: 0
Sessions-in-use: 0
  Valid sessions: 0
  Pending sessions: 0
  Invalidated sessions: 0
  Sessions in other states: 0
Maximum-sessions: 6291456

```

show security flow session summary node all

```

root@host> show security flow session summary node all
node0:

```

```

-----

Flow Sessions on FPC0 PIC1:
Unicast-sessions: 1
Multicast-sessions: 0
Services-offload-sessions: 0
Failed-sessions: 0
Sessions-in-use: 1
  Valid sessions: 1
  Pending sessions: 0
  Invalidated sessions: 0
  Sessions in other states: 0
Maximum-sessions: 6291456

```

```

Flow Sessions on FPC0 PIC2:

```

Unicast-sessions: 0
Multicast-sessions: 0
Services-offload-sessions: 0
Failed-sessions: 0
Sessions-in-use: 0
 Valid sessions: 0
 Pending sessions: 0
 Invalidated sessions: 0
 Sessions in other states: 0
Maximum-sessions: 6291456

Flow Sessions on FPC0 PIC3:

Unicast-sessions: 0
Multicast-sessions: 0
Services-offload-sessions: 0
Failed-sessions: 0
Sessions-in-use: 0
 Valid sessions: 0
 Pending sessions: 0
 Invalidated sessions: 0
 Sessions in other states: 0
Maximum-sessions: 6291456

node1:

Flow Sessions on FPC0 PIC1:

Unicast-sessions: 1
Multicast-sessions: 0
Services-offload-sessions: 0
Failed-sessions: 0
Sessions-in-use: 1
 Valid sessions: 1
 Pending sessions: 0
 Invalidated sessions: 0
 Sessions in other states: 0
Maximum-sessions: 6291456

Flow Sessions on FPC0 PIC2:

Unicast-sessions: 0
Multicast-sessions: 0
Services-offload-sessions: 0
Failed-sessions: 0

```
Sessions-in-use: 0
  Valid sessions: 0
  Pending sessions: 0
  Invalidated sessions: 0
  Sessions in other states: 0
Maximum-sessions: 6291456
```

```
Flow Sessions on FPC0 PIC3:
Unicast-sessions: 0
Multicast-sessions: 0
Services-offload-sessions: 0
Failed-sessions: 0
Sessions-in-use: 0
  Valid sessions: 0
  Pending sessions: 0
  Invalidated sessions: 0
  Sessions in other states: 0
Maximum-sessions: 6291456
```

show security flow session summary node local

```
root@host> show security flow session summary node local
node0:
```

```
-----

Flow Sessions on FPC0 PIC1:
Unicast-sessions: 1
Multicast-sessions: 0
Services-offload-sessions: 0
Failed-sessions: 0
Sessions-in-use: 1
  Valid sessions: 1
  Pending sessions: 0
  Invalidated sessions: 0
  Sessions in other states: 0
Maximum-sessions: 6291456
```

```
Flow Sessions on FPC0 PIC2:
Unicast-sessions: 0
Multicast-sessions: 0
```

```

Services-offload-sessions: 0
Failed-sessions: 0
Sessions-in-use: 0
  Valid sessions: 0
  Pending sessions: 0
  Invalidated sessions: 0
  Sessions in other states: 0
Maximum-sessions: 6291456

```

```

Flow Sessions on FPC0 PIC3:
Unicast-sessions: 0
Multicast-sessions: 0
Services-offload-sessions: 0
Failed-sessions: 0
Sessions-in-use: 0
  Valid sessions: 0
  Pending sessions: 0
  Invalidated sessions: 0
  Sessions in other states: 0
Maximum-sessions: 6291456

```

show security flow session summary node primary

```
root@host> show security flow session summary node primary
```

```
node0:
```

```

-----
Flow Sessions on FPC0 PIC1:
Unicast-sessions: 1
Multicast-sessions: 0
Services-offload-sessions: 0
Failed-sessions: 0
Sessions-in-use: 1
  Valid sessions: 1
  Pending sessions: 0
  Invalidated sessions: 0
  Sessions in other states: 0
Maximum-sessions: 6291456

```

```

Flow Sessions on FPC0 PIC2:
Unicast-sessions: 0

```

```

Multicast-sessions: 0
Services-offload-sessions: 0
Failed-sessions: 0
Sessions-in-use: 0
  Valid sessions: 0
  Pending sessions: 0
  Invalidated sessions: 0
  Sessions in other states: 0
Maximum-sessions: 6291456

Flow Sessions on FPC0 PIC3:
Unicast-sessions: 0
Multicast-sessions: 0
Services-offload-sessions: 0
Failed-sessions: 0
Sessions-in-use: 0
  Valid sessions: 0
  Pending sessions: 0
  Invalidated sessions: 0
  Sessions in other states: 0
Maximum-sessions: 6291456

```

Release Information

Command introduced in Junos OS Release 8.5; node options added in Junos OS Release 9.0. Filter options added in Junos OS Release 10.2.

Support on SRX Series Firewalls for flow-based mode for family inet6 added in Junos OS Release 10.2.

Support for IPv6 addresses in active/active chassis cluster configurations (in addition to the existing support of active/passive chassis cluster configurations) added in Junos OS Release 10.4.

RELATED DOCUMENTATION

[Understanding Traffic Processing on Security Devices | 2](#)

[show security flow session | 656](#)

show security flow session summary services-offload

IN THIS SECTION

- [Syntax | 785](#)
- [Description | 785](#)
- [Options | 785](#)
- [Required Privilege Level | 786](#)
- [Output Fields | 786](#)
- [Sample Output | 787](#)
- [Release Information | 790](#)

Syntax

```
show security flow session summary services-offload [filter]
```

Description

Display information about all currently active services-offload security sessions on the device in summary mode.

Options

- *filter*—Filter the display by the specified criteria.

The following filters reduce the display to those sessions that match the criteria specified by the filter:

<code>application</code>	Application name.
<code>application-firewall-rule-set</code>	Application firewall enabled with the specified rule set.
<code>application-traffic-control-rule-set</code>	Application traffic control enabled with the specified rule set.
<code>destination-port</code>	Destination port.
<code>destination-prefix</code>	Destination IP prefix or address.
<code>dynamic-application</code>	Dynamic application name.
<code>dynamic-application-group</code>	Dynamic application group name.
<code>family</code>	Protocol family.
<code>interface</code>	Name of incoming or outgoing interface.
<code>logical-system</code>	Logical system name.
<code>protocol</code>	IP protocol number.
<code>root-logical-system</code>	Root logical system name.
<code>source-port</code>	Source port.
<code>source-prefix</code>	Source IP prefix or address.

Required Privilege Level

view

Output Fields

[Table 70 on page 787](#) lists the output fields for the `show security flow session summary services-offload` command. Output fields are listed in the approximate order in which they appear.

Table 70: show security flow session summary services-offload Output Fields

Field Name	Field Description
Unicast-sessions	Number of unicast sessions.
Multicast-sessions	Number of multicast sessions.
Services-offload-sessions	Number of services-offload sessions.
Failed-sessions	Number of failed sessions.
Sessions-in-use	Number of sessions in use: <ul style="list-style-type: none"> • Valid • Pending • Invalidated • Sessions in other states
Maximum-sessions	Maximum number of sessions.

Sample Output

show security flow session summary services-offload

```

user@host> show security flow session summary services-offload
Flow Sessions on FPC1 PIC0:
Unicast-sessions: 0
Multicast-sessions: 0
Services-offload-sessions: 0
Failed-sessions: 0
Sessions-in-use: 0
  Valid sessions: 0
  Pending sessions: 0

```

Invalidated sessions: 0
Sessions in other states: 0
Maximum-sessions: 409600

Flow Sessions on FPC2 PIC0:

Unicast-sessions: 1
Multicast-sessions: 0
Services-offload-sessions: 1
Failed-sessions: 0
Sessions-in-use: 1
Valid sessions: 1
Pending sessions: 0
Invalidated sessions: 0
Sessions in other states: 0
Maximum-sessions: 819200

Flow Sessions on FPC3 PIC0:

Unicast-sessions: 0
Multicast-sessions: 0
Services-offload-sessions: 0
Failed-sessions: 0
Sessions-in-use: 0
Valid sessions: 0
Pending sessions: 0
Invalidated sessions: 0
Sessions in other states: 0
Maximum-sessions: 819200

Flow Sessions on FPC5 PIC0:

Unicast-sessions: 0
Multicast-sessions: 0
Services-offload-sessions: 0
Failed-sessions: 0
Sessions-in-use: 0
Valid sessions: 0
Pending sessions: 0
Invalidated sessions: 0
Sessions in other states: 0
Maximum-sessions: 819200

show security flow session summary services-offload application

```
user@host> show security flow session summary services-offload application telnet
Flow Sessions on FPC10 PIC1:

Valid sessions: 0
Pending sessions: 0
Invalidated sessions: 0
Sessions in other states: 0
Total sessions: 0

Flow Sessions on FPC10 PIC2:

Valid sessions: 0
Pending sessions: 0
Invalidated sessions: 0
Sessions in other states: 0
Total sessions: 0

Flow Sessions on FPC10 PIC3:

Valid sessions: 1
Pending sessions: 0
Invalidated sessions: 0
Sessions in other states: 0
Total sessions: 1
```

show security flow session summary services-offload destination-port

```
user@host> show security flow session summary services-offload destination-port 23
Flow Sessions on FPC10 PIC1:
Total sessions: 0

Flow Sessions on FPC10 PIC2:
Total sessions: 0

Flow Sessions on FPC10 PIC3:

Session ID: 430000004, Policy name: p1/4, Timeout: 1500, Valid
```

```
In: 200.0.0.10/15200 --> 60.0.0.2/23;tcp, If: ge-7/1/0.0, Pkts: 13, Bytes: 718, CP Session ID: 430000003
Out: 60.0.0.2/23 --> 200.0.0.10/15200;tcp, If: ge-7/1/1.0, Pkts: 12, Bytes: 677, CP Session ID: 430000003
Total sessions: 1
```

Release Information

Command introduced in Junos OS Release 11.4.

Starting with Junos OS Release 15.1X49-D10 and Junos OS Release 17.3R1, the SRX5K-MPC3-100G10G (IOC3) and the SRX5K-MPC3-40G10G (IOC3) with Express Path (formerly known as *services offloading*) support are introduced for SRX5400, SRX5600, and SRX5800 devices.

This command is supported on the SRX1500, SRX 5800, SRX 5600, and SRX 5400 devices, and vSRX Virtual Firewall.

RELATED DOCUMENTATION

[Understanding Traffic Processing on Security Devices | 2](#)

[clear security flow session services-offload | 473](#)

show security flow session tunnel

IN THIS SECTION

- [Syntax | 791](#)
- [Description | 791](#)
- [Options | 791](#)
- [Required Privilege Level | 791](#)
- [Output Fields | 791](#)
- [Sample Output | 794](#)
- [Release Information | 801](#)

Syntax

```
show security flow session tunnel  
[brief | extensive | summary]
```

Description

Display information about all tunnel sessions.

Options

none—Display the brief (default) level of output.

brief—Display the specified brief level of output.

extensive—Display the information about all current active sessions.

summary—Display the session information on each FPC.

Required Privilege Level

view

Output Fields

[Table 71 on page 792](#) lists the output fields for the `show security flow session tunnel` command. Output fields are listed in the approximate order in which they appear.

Table 71: show security flow session tunnel Output Fields

Field Name	Field Description
Session ID	Number that identifies the session. You can use this ID to get additional information about the session.
Policy name	Policy that permitted the traffic. NA (Not Applicable) for a tunnel session.
Source NAT pool	The name of the source pool where NAT is used.
Timeout	Idle timeout after which the session expires. NA (Not Applicable) for a tunnel session.
In	Incoming flow (source and destination IP addresses, application protocol, interface, session token, route, gateway, tunnel, encapsulation and authentication header fragments generated, inner IPv4 fragments generated, inner IPv6 fragments generated, port sequence, FIN sequence, FIN state, packets and bytes).
Total sessions	Total number of sessions.
Status	Session status.
Flags	Internal flag depicting the state of the session, used for debugging purposes.
Source NAT pool	The name of the source pool where NAT is used.
Application	Name of the application.
Maximum timeout	Maximum session timeout.
Current timeout	Remaining time for the session unless traffic exists in the session.
Encryption	Encryption traffic name.

Table 71: show security flow session tunnel Output Fields (Continued)

Field Name	Field Description
Session State	Session state.
Start time	Time when the session was created, offset from the system start time.
Session token	Internal token derived from the virtual routing instance.
Route	Internal next hop of the route to be used by the flow.
Valid sessions	Number of valid sessions.
Pending sessions	Number of pending sessions.
Invalidated sessions	Number of invalidated sessions.
Sessions in other states	Number of sessions in other states.
ESP/AH frag Rx: <i>number</i> , Generated: <i>number</i>	For IPsec tunnels, the number of Encapsulating Security Payload (ESP) or Authentication Header (AH) fragments that were received and the number that were generated.
Inner IPv4 frag Rx: <i>number</i> , Tx: <i>number</i> , Generated: <i>number</i>	For tunnels with IPv4 fragments, the number of fragments associated with the tunnel that were received, transmitted, and generated.
Inner IPv6 frag Rx: <i>number</i> , Tx: <i>number</i> , Generated: <i>number</i>	For tunnels with IPv6 fragments, the number of fragments associated with the tunnel that were received, transmitted, and generated.

Sample Output

show security flow session tunnel

```
root> show security flow session tunnel
Flow Sessions on FPC10 PIC1:

Session ID: 410000001, Policy name: N/A, Timeout: N/A, Valid
  In: 60.0.0.2/43405 --> 60.0.0.3/494;esp, If: ge-7/1/1.0, Pkts: 0, Bytes: 0, CP Session ID:
420000000

Session ID: 410000002, Policy name: N/A, Timeout: N/A, Valid
  In: 60.0.0.2/0 --> 60.0.0.3/0;esp, If: ge-7/1/1.0, Pkts: 0, Bytes: 0, CP Session ID: 420000000
Total sessions: 2

Flow Sessions on FPC10 PIC2:

Session ID: 420000003, Policy name: N/A, Timeout: N/A, Valid
  In: 60.0.0.2/0 --> 60.0.0.3/0;esp, If: ge-7/1/1.0, Pkts: 0, Bytes: 0, CP Session ID: 420000000

Session ID: 420000004, Policy name: N/A, Timeout: N/A, Valid
  In: 60.0.0.2/0 --> 60.0.0.3/0;ah, If: ge-7/1/1.0, Pkts: 0, Bytes: 0, CP Session ID: 420000000
Total sessions: 2

Flow Sessions on FPC10 PIC3:

Session ID: 430000005, Policy name: N/A, Timeout: N/A, Valid
  In: 60.0.0.2/0 --> 60.0.0.3/0;esp, If: ge-7/1/1.0, Pkts: 0, Bytes: 0, CP Session ID: 420000000

Session ID: 430000006, Policy name: N/A, Timeout: N/A, Valid
  In: 60.0.0.2/0 --> 60.0.0.3/0;ah, If: ge-7/1/1.0, Pkts: 0, Bytes: 0, CP Session ID: 420000000
Total sessions: 2
```

show security flow session tunnel brief

```
root> show security flow session tunnel brief
Flow Sessions on FPC10 PIC1:

Session ID: 410000001, Policy name: N/A, Timeout: N/A, Valid
  In: 60.0.0.2/43405 --> 60.0.0.3/494;esp, If: ge-7/1/1.0, Pkts: 0, Bytes: 0, CP Session ID:
```

420000000

Session ID: 410000002, Policy name: N/A, Timeout: N/A, Valid

In: 60.0.0.2/0 --> 60.0.0.3/0;esp, If: ge-7/1/1.0, Pkts: 0, Bytes: 0, CP Session ID: 420000000
Total sessions: 2

Flow Sessions on FPC10 PIC2:

Session ID: 420000003, Policy name: N/A, Timeout: N/A, Valid

In: 60.0.0.2/0 --> 60.0.0.3/0;esp, If: ge-7/1/1.0, Pkts: 0, Bytes: 0, CP Session ID: 420000000

Session ID: 420000004, Policy name: N/A, Timeout: N/A, Valid

In: 60.0.0.2/0 --> 60.0.0.3/0;ah, If: ge-7/1/1.0, Pkts: 0, Bytes: 0, CP Session ID: 420000000
Total sessions: 2

Flow Sessions on FPC10 PIC3:

Session ID: 430000005, Policy name: N/A, Timeout: N/A, Valid

In: 60.0.0.2/0 --> 60.0.0.3/0;esp, If: ge-7/1/1.0, Pkts: 0, Bytes: 0, CP Session ID: 420000000

Session ID: 430000006, Policy name: N/A, Timeout: N/A, Valid

In: 60.0.0.2/0 --> 60.0.0.3/0;ah, If: ge-7/1/1.0, Pkts: 0, Bytes: 0, CP Session ID: 420000000
Total sessions: 2

show security flow session tunnel extensive

```
root> show security flow session tunnel extensive
```

Flow Sessions on FPC10 PIC1:

Session ID: 410000001, Status: Normal

Flags: 0x10000/0x0/0x1

Policy name: N/A

Source NAT pool: Null

Dynamic application: junos:UNKNOWN,

Encryption: Unknown

Application traffic control rule-set: INVALID, Rule: INVALID

Maximum timeout: N/A, Current timeout: N/A

Session State: Valid

Start time: 3548, Duration: 797

In: 60.0.0.2/43405 --> 60.0.0.3/494;esp,

Interface: ge-7/1/1.0,

Session token: 0x7, Flag: 0x80100621
Route: 0x60010, Gateway: 60.0.0.2, Tunnel: 0
ESP/AH frag Rx: 0, Generated: 0
 Inner IPv4 frag Rx: 4, Tx: 4, Generated: 4,
 Inner IPv6 frag Rx: 0, Tx: 0, Generated: 0
Port sequence: 0, FIN sequence: 0,
FIN state: 0,
Pkts: 0, Bytes: 0
CP Session ID: 420000000

Session ID: 410000002, Status: Normal
Flags: 0x10000/0x0/0x1
Policy name: N/A
Source NAT pool: Null
Dynamic application: junos:UNKNOWN,
Encryption: Unknown
Application traffic control rule-set: INVALID, Rule: INVALID
Maximum timeout: N/A, Current timeout: N/A
Session State: Valid
Start time: 3548, Duration: 797
 In: 60.0.0.2/0 --> 60.0.0.3/0;esp,
 Interface: ge-7/1/1.0,
 Session token: 0x7, Flag: 0x621
 Route: 0x60010, Gateway: 60.0.0.2, Tunnel: 0
 Port sequence: 0, FIN sequence: 0,
 FIN state: 0,
 Pkts: 0, Bytes: 0
 CP Session ID: 420000000
Total sessions: 2

Flow Sessions on FPC10 PIC2:

Session ID: 420000003, Status: Normal
Flags: 0x10000/0x0/0x1
Policy name: N/A
Source NAT pool: Null
Dynamic application: junos:UNKNOWN,
Encryption: Unknown
Application traffic control rule-set: INVALID, Rule: INVALID
Maximum timeout: N/A, Current timeout: N/A
Session State: Valid
Start time: 3513, Duration: 798
 In: 60.0.0.2/0 --> 60.0.0.3/0;esp,

Interface: ge-7/1/1.0,
Session token: 0x7, Flag: 0x621
Route: 0x0, Gateway: 60.0.0.2, Tunnel: 0
Port sequence: 0, FIN sequence: 0,
FIN state: 0,
Pkts: 0, Bytes: 0
CP Session ID: 420000000

Session ID: 420000004, Status: Normal
Flags: 0x10000/0x0/0x1
Policy name: N/A
Source NAT pool: Null
Dynamic application: junos:UNKNOWN,
Encryption: Unknown
Application traffic control rule-set: INVALID, Rule: INVALID
Maximum timeout: N/A, Current timeout: N/A
Session State: Valid
Start time: 3513, Duration: 798
In: 60.0.0.2/0 --> 60.0.0.3/0;ah,
Interface: ge-7/1/1.0,
Session token: 0x7, Flag: 0x621
Route: 0x0, Gateway: 60.0.0.2, Tunnel: 0
Port sequence: 0, FIN sequence: 0,
FIN state: 0,
Pkts: 0, Bytes: 0
CP Session ID: 420000000
Total sessions: 2

Flow Sessions on FPC10 PIC3:

Session ID: 430000005, Status: Normal
Flags: 0x10000/0x0/0x1
Policy name: N/A
Source NAT pool: Null
Dynamic application: junos:UNKNOWN,
Encryption: Unknown
Application traffic control rule-set: INVALID, Rule: INVALID
Maximum timeout: N/A, Current timeout: N/A
Session State: Valid
Start time: 3513, Duration: 799
In: 60.0.0.2/0 --> 60.0.0.3/0;esp,
Interface: ge-7/1/1.0,

```

Session token: 0x7, Flag: 0x621
Route: 0x0, Gateway: 60.0.0.2, Tunnel: 0
Port sequence: 0, FIN sequence: 0,
FIN state: 0,
Pkts: 0, Bytes: 0
CP Session ID: 42000000

```

```

Session ID: 43000006, Status: Normal
Flags: 0x10000/0x0/0x1
Policy name: N/A
Source NAT pool: Null
Dynamic application: junos:UNKNOWN,
Encryption: Unknown
Application traffic control rule-set: INVALID, Rule: INVALID
Maximum timeout: N/A, Current timeout: N/A
Session State: Valid
Start time: 3513, Duration: 799
  In: 60.0.0.2/0 --> 60.0.0.3/0;ah,
  Interface: ge-7/1/1.0,
  Session token: 0x7, Flag: 0x621
  Route: 0x0, Gateway: 60.0.0.2, Tunnel: 0
  Port sequence: 0, FIN sequence: 0,
  FIN state: 0,
  Pkts: 0, Bytes: 0
  CP Session ID: 42000000
Total sessions: 2

```

show security flow session tunnel summary extensive (with fragmentation counters output)

```

root> show security flow session tunnel extensive
node0:
Flow Sessions on FPC2 PIC1:
  Session ID: 90000004, Status: Normal, State: Active
  Flags: 0x10000/0x0/0x1
  Policy name: N/A
  Source NAT pool: Null
  Dynamic application: junos:UNKNOWN,
  Encryption: Unknown
  Application traffic control rule-set: INVALID, Rule: INVALID
  Maximum timeout: N/A, Current timeout: N/A
  Session State: Valid

```

Start time: 6251, Duration: 167168

In: 2.2.2.2/0 --> 2.2.2.1/10203;esp,
Conn Tag: 0x0, Interface: reth1.0,
Session token: 0x7, Flag: 0x80100621
Route: 0x867f3c1, Gateway: 2.2.2.2, Tunnel: 0
ESP/AH frag Rx: 0, Generated: 0
Inner IPv4 frag Rx: 27, Tx: 27, Generated: 18,
Inner IPv6 frag Rx: 0, Tx: 0, Generated: 0
Port sequence: 0, FIN sequence: 0,
FIN state: 0,
Pkts: 0, Bytes: 0
CP Session ID: 90000000

Session ID: 90000005, Status: Normal, State: Active

Flags: 0x10000/0x0/0x1

Policy name: N/A

Source NAT pool: Null

Dynamic application: junos:UNKNOWN,

Encryption: Unknown

Application traffic control rule-set: INVALID, Rule: INVALID

Maximum timeout: N/A,

Current timeout: N/A

Session State: Valid

Start time: 6251, Duration: 167168

In: 2.2.2.2/0 --> 2.2.2.1/0;esp,
Conn Tag: 0x0, Interface: reth1.0,
Session token: 0x7, Flag: 0x100621
Route: 0x867f3c1, Gateway: 2.2.2.2, Tunnel: 0
ESP/AH frag Rx: 0, Generated: 0
Inner IPv4 frag Rx: 0, Tx: 0, Generated: 0,
Inner IPv6 frag Rx: 0, Tx: 0, Generated: 0
Port sequence: 0,
FIN sequence: 0,
FIN state: 0,
Pkts: 0, Bytes: 0

CP Session ID: 90000000

Total sessions: 2

show security flow session tunnel summary (with fragmentation counters output)

```
root> show security flow session tunnel summary
```

```
node0:
```

```
Flow Sessions on FPC2 PIC1:
```

```
Valid sessions: 2
```

```
Pending sessions: 0
```

```
Invalidated sessions: 0
```

```
Sessions in other states: 0
```

```
Total sessions: 2
```

```
Tunnel fragment summary:
```

```
Tunnels with ESP/AH frag Rx: 0 (0)
```

```
Tunnels with ESP/AH frag generated: 0 (0)
```

```
Tunnels with IPv4 frag Rx: 1 (27)
```

```
Tunnels with IPv4 frag Tx: 1 (27)
```

```
Tunnels with IPv4 frag generated: 1 (18)
```

```
Tunnels with IPv6 frag Rx: 0 (0)
```

```
Tunnels with IPv6 frag Tx: 0 (0)
```

```
Tunnels with IPv6 frag generated: 0 (0)
```

```
Flow Sessions on FPC2 PIC1:
```

```
Valid sessions: 2
```

```
Pending sessions: 0
```

```
Invalidated sessions: 0
```

```
Sessions in other states: 0
```

```
Total sessions: 2
```

```
Tunnel fragment summary:
```

```
Tunnels with ESP/AH frag Rx: 0 (0)
```

```
Tunnels with ESP/AH frag generated: 0 (0)
```

```
Tunnels with IPv4 frag Rx: 0 (0)
```

```
Tunnels with IPv4 frag Tx: 0 (0)
```

```
Tunnels with IPv4 frag generated: 0 (0)
```

```
Tunnels with IPv6 frag Rx: 0 (0)
```

```
Tunnels with IPv6 frag Tx: 0 (0)
```

```
Tunnels with IPv6 frag generated: 0 (0)
```

Flow Sessions on FPC2 PIC3:

Valid sessions: 2

Pending sessions: 0

Invalidated sessions: 0

Sessions in other states: 0

Total sessions: 2

Tunnel fragment summary:

Tunnels with ESP/AH frag Rx: 0 (0)

Tunnels with ESP/AH frag generated: 0 (0)

Tunnels with IPv4 frag Rx: 0 (0)

Tunnels with IPv4 frag Tx: 0 (0)

Tunnels with IPv4 frag generated: 0 (0)

Tunnels with IPv6 frag Rx: 0 (0)

Tunnels with IPv6 frag Tx: 0 (0)

Tunnels with IPv6 frag generated: 0 (0)

Tunnel fragment summary:

Tunnels with ESP/AH frag Rx: 0 (0)

Tunnels with ESP/AH frag generated: 0 (0)

Tunnels with IPv4 frag Rx: 1 (27)

Tunnels with IPv4 frag Tx: 1 (27)

Tunnels with IPv4 frag generated: 1 (18)

Tunnels with IPv6 frag Rx: 0 (0)

Tunnels with IPv6 frag Tx: 0 (0)

Tunnels with IPv6 frag generated: 0 (0)

Release Information

Command introduced in Junos OS Release 8.5; Filter and view options introduced in Junos OS Release 10.2. Fragmentation counters options introduced in Junos OS Release 15.1X49-90.

NOTE: Only `show security flow session tunnel extensive` and `show security flow session tunnel summary` provide fragmentation counters output.

RELATED DOCUMENTATION

[Understanding Traffic Processing on Security Devices | 2](#)

show security flow statistics

IN THIS SECTION

- [Syntax | 802](#)
- [Description | 802](#)
- [Options | 804](#)
- [Required Privilege Level | 804](#)
- [Output Fields | 804](#)
- [Sample Output | 806](#)
- [Release Information | 808](#)

Syntax

```
show security flow statistics
<node (node-id | all | local | primary)>
<logical-system (logical-system-name | all)>
<tenant (tenant-name | all)>
```

Description

Display security flow statistics on a specific SPU. A flow is a stream of related packets that meet the same matching criteria and share the same characteristics.

A packet undergoes flow-based processing after packet-based filters and some screens have been applied to it. A System Processing Unit (SPU) processes the packets of a flow according to the security features and other services configured for the session. Flow-based packet processing treats related

packets, or a stream of packets, in the same way. Packet treatment depends on characteristics that were established for the first packet of the packet stream.

The `show security flow statistics` command displays information for individual SPUs. For each SPU, the active sessions on the SPU, packets received, packets transmitted, packets forwarded/queued, packets copied, packets dropped, packet fragments received in a flow on the SPU, pre-fragmented packets generated, and post-fragmented packets generated are displayed in terms of numbers.

There are many conditions that can cause a packet to be dropped. Here are some of them:

- A screen module detects IP spoofing
- The IPsec Encapsulating Security Payload (ESP) or the Authentication Header (AH) authentication failed. For example, incoming NAT errors could cause this to happen.
- A packet matches more than one security policy that specifies user authentication. (Sometimes packets are looped through the system more than once. Each time a packet passes through the system, that packet must be permitted by a policy.)
- A time constraint setting expires. For example, multicast streams with a packet interval of more than 60 seconds would experience premature aging-out of flow sessions. (In most cases, you can configure higher time-out value to prevent packet drop.)

Packet fragmentation can occur for a number of reasons, and, in some cases, it can be controlled through a configuration setting. Every link has a maximum transmission unit (MTU) size that specifies the size of the largest packet that the link can transmit. A larger MTU size means that fewer packets are required to transmit a certain amount of data. However, for a packet to successfully traverse the path from the source node to the destination node, the MTU size of the source node egress interface must be no larger than that of the smallest MTU size of all nodes on the path between the source and destination. This value is referred to as the path maximum transmission unit (path MTU).

When a packet is larger than the MTU size on any link in the data path, the link might fragment it or drop it.

- For IPv4, if a node within the path between a source node and a destination node receives a packet that is larger than its MTU size, it can fragment the packet and transmit the resulting smaller packets.
- For IPv6, an intermediate node cannot fragment a packet. If a packet is larger than a link's MTU size, it is likely that the link will drop it. However, the source node (the node that sent the packet) can fragment a packet, and this is done to accommodate a path MTU size-adjustment requirement. Nodes along the path of a packet cannot fragment the packet to transmit it.

The fragmentation counters feature for IPsec tunnels provides the show output information for the pre-fragments generated and post-fragments generated fields.

Starting in Junos OS Release 15.1X49-D10 and Junos OS Release 17.3R1, SRX5K-MPC3-100G10G (IOC3) and SRX5K-MPC3-40G10G (IOC3) are introduced for SRX5400, SRX5600, and SRX5800 devices

that perform hash-based datapath packet forwarding to interconnect with all existing IOC and SPC cards using the XL chip (packet-processing chip). The IOC3 XL chip uses a hash-based method to distribute ingress traffic to a pool of SPUs by default.

Options

<code>none</code>	Displays the security flow statistics information.
<code>node</code>	(Optional) For chassis cluster configurations, displays all security flow statistics on a specific node (device) in the cluster. <ul style="list-style-type: none"> <code>node-id</code>—Identification number of the node. It can be 0 or 1. <code>all</code>—Displays information about all nodes. <code>local</code>—Displays information about the local node. <code>primary</code>—Displays information about the primary node.
<code>logical-system</code> <code>logical-system-</code> <code>name</code>	(Optional) Displays information about the specified logical system.
<code>logical-system all</code>	(Optional) Displays information about all the logical systems.
<code>tenant tenant-name</code>	(Optional) Displays information about the specified tenant system.
<code>tenant all</code>	(Optional) Displays information about all tenant systems.

Required Privilege Level

view

Output Fields

[Table 72 on page 805](#) lists the output fields for the `show security flow statistics` command. Output fields are listed in the approximate order in which they appear.

Table 72: show security flow statistics Output Fields

Field Name	Field Description
Current sessions	Number of active sessions on the SPU.
Packets received	Number of packets received in a security flow of a specific SPU. The packets are processed and forwarded on that SPU.
Packets transmitted	Number of packets returned to Jexec for transmission.
Packets forwarded/queued	Number of packets forwarded or number of packets queued up by other modules. NOTE: Dropped packets are not captured by this field.
Packets copied	Number of packets copied by other modules including fragmentation and tcp proxy.
Packets dropped	Number of packets dropped in a flow on a specific SPU. The packets are received in the flow. However, during processing, the system discovers sanity check errors, security violations, or other conditions that caused the packet to be dropped. See the description for some of the conditions and events that can cause a packet to be dropped.
Fragment packets	Number of fragments received in a flow on the SPU. See the description for information about packet fragments.
Pre fragments generated	For IPsec tunnels, the number of fragments that are self-generated by the SRX Series Firewall before it encapsulates the packet with the IPsec encryption header.
Post fragments generated	For IPsec tunnels, the number of fragments that are received by the SRX Series Firewall and packets that are fragmented after encryption.

Sample Output

show security flow statistics

```
user@host> show security flow statistics
```

```
node0:
```

```
-----
```

```
Current sessions: 0
Packets received: 2677
Packets transmitted: 2278
Packets forwarded/queued: 0
Packets copied: 99
Packets dropped: 300
Fragment packets: 0
Pre fragments generated: 0
Post fragments generated: 0
```

```
node1:
```

```
-----
```

```
Current sessions: 0
Packets received: 1267
Packets transmitted: 904
Packets forwarded/queued: 0
Packets copied: 0
Packets dropped: 363
Fragment packets: 0
Pre fragments generated: 0
Post fragments generated: 0
```

show security flow statistics logical-system LSYS1

```
user@host> show security flow statistics logical-system LSYS1
```

```
Current sessions: 1000
Packets received: 177888012
Packets transmitted: 66705150
Packets forwarded/queued: 14
Packets copied: 77831798
Packets dropped: 33351074
```

```
Services-offload packets processed: 16574037502
Fragment packets: 0
Pre fragments generated: 0
Post fragments generated: 0
```

show security flow statistics

```
user@host:LSYS1> show security flow statistics
Current sessions: 1000
    Packets received: 177888012
    Packets transmitted: 66705150
    Packets forwarded/queued: 14
    Packets copied: 77831798
    Packets dropped: 33351074
    Services-offload packets processed: 16574037502
    Fragment packets: 0
    Pre fragments generated: 0
    Post fragments generated: 0
```

show security flow statistics tenant TSYS1

```
user@host> show security flow statistics tenant TSYS1
Current sessions: 10
    Packets received: 28711
    Packets transmitted: 10
    Packets forwarded/queued: 0
    Packets copied: 9590
    Packets dropped: 19541
    Services-offload packets processed: 95909
    Fragment packets: 0
    Pre fragments generated: 0
    Post fragments generated: 0
```

show security flow statistics

```
user@host:TSYS1> show security flow statistics
Current sessions: 10
    Packets received: 28711
```

```
Packets transmitted: 10
Packets forwarded/queued: 0
Packets copied: 9590
Packets dropped: 19541
Services-offload packets processed: 95909
Fragment packets: 0
Pre fragments generated: 0
Post fragments generated: 0
```

Release Information

Command introduced in Junos OS Release 10.2.

Fragmentation counters options introduced in Junos OS Release 15.1X49-90.

Support added at the logical system and tenant system level in Junos OS Release 20.1R1.

RELATED DOCUMENTATION

[Understanding Traffic Processing on Security Devices | 2](#)

show security flow status

IN THIS SECTION

- [Syntax | 809](#)
- [Description | 809](#)
- [Required Privilege Level | 809](#)
- [Output Fields | 809](#)
- [Sample Output | 811](#)
- [Release Information | 818](#)

Syntax

```
show security flow status
```

Description

Display the flow processing modes and logging status.

Required Privilege Level

view

Output Fields

[Table 73 on page 810](#) lists the output fields for the `show security flow status` command. Output fields are listed in the approximate order in which they appear.

Table 73: show security flow status Output Fields

Field Name	Field Description
Flow forwarding mode	Flow processing mode. <ul style="list-style-type: none"> • Inet forwarding mode • Inet6 forwarding mode • MPLS forwarding mode • ISO forwarding mode • Session distribution mode • Enhanced route scaling mode • Tap mode: enabled, inspect ipip
Flow trace status	Flow logging status. <ul style="list-style-type: none"> • Flow tracing status • Flow tracing options
flow session distribution	SPU load distribution mode. <ul style="list-style-type: none"> • RR-based • Hash-based GTP-U distribution <ul style="list-style-type: none"> • Enabled
Flow packet ordering	packet-ordering mode. <ul style="list-style-type: none"> • Hardware • Software
Flow ipsec performance acceleration	IPsec VPN performance acceleration status.

Table 73: show security flow status Output Fields (Continued)

Field Name	Field Description
Flow power mode IPsec	Flow PowerMode IPsec status.
Flow Enhanced Service Mode	Flow Enhanced Service Mode status <ul style="list-style-type: none"> • Disabled • Enabled • Disabled (reboot needed to enable Enhanced Service Mode) • Enabled (reboot needed to disable Enhanced Service Mode)
Flow gre performance acceleration	GRE performance acceleration status.

Sample Output

show security flow status

```

user@host> show security flow status
Flow forwarding mode:
  Inet forwarding mode: flow based
  Inet6 forwarding mode: flow based
  MPLS forwarding mode: drop
  ISO forwarding mode: drop
  Tap mode: disabled (default)
  Enhanced services mode: Disabled
Flow trace status
  Flow tracing status: on
  Flow tracing options: all
  Flow tracing level: detail
  Flow trace root-override status: on
Flow session distribution
  Distribution mode: Hash-based
  GTP-U distribution: Disabled

```

```

Flow ipsec performance acceleration: off
Flow gre performance acceleration: off
Flow packet ordering
  Ordering mode: Hardware
Flow power mode IPsec: Disabled
Flow power mode IPsec QAT: Disabled
Fat core group status: off
Flow inline fpga crypto: Disabled

```

```
node1:
```

```

-----
Flow forwarding mode:
  Inet forwarding mode: flow based
  Inet6 forwarding mode: flow based
  MPLS forwarding mode: drop
  ISO forwarding mode: drop
  Tap mode: disabled (default)
Flow trace status
  Flow tracing status: off
Flow session distribution
  Distribution mode: RR-based
  GTP-U distribution: Disabled
  SCTP distribution: Enabled
Flow ipsec performance acceleration: off
Flow gre performance acceleration: off
Flow packet ordering
  Ordering mode: Hardware
Flow power mode: Enabled
Flow power mode IPsec: Enabled
Flow power mode IPsec QAT: Disabled
Fat core group status: off
Flow inline fpga crypto: Disabled

```

Logical system or tenant system user output.

```

Flow trace status
Flow tracing status: on
Flow tracing options: all

```

```
Flow tracing level: detail
Flow trace root-override status: on
```

```
user@host> show security flow status
Flow forwarding mode:
  Inet forwarding mode: flow based
  Inet6 forwarding mode: drop
  MPLS forwarding mode: drop
  ISO forwarding mode: drop
  TAP mode: enabled
Flow trace status
Flow tracing status: off
Flow session distribution
  Distribution mode: RR-based
  GTP-U distribution: Enabled Flow packet ordering
  Ordering mode: Software (reboot needed to change to software)
Flow power mode IPsec: Enabled
```

show security flow status (IPsec Performance Acceleration)

```
user@host> show security flow status
node0:
-----
Flow forwarding mode:
  Inet forwarding mode: flow based
  Inet6 forwarding mode: flow based
  MPLS forwarding mode: drop
  ISO forwarding mode: drop
  Tap mode: disabled (default)
Flow trace status
  Flow tracing status: off
Flow session distribution
  Distribution mode: Hash-based
  GTP-U distribution: Disabled
Flow ipsec performance acceleration: off
Flow packet ordering
  Ordering mode: Hardware
Flow power mode IPsec: Enabled
Fat core group status: on
node1:
```

```
Flow forwarding mode:
Inet forwarding mode: flow based
Inet6 forwarding mode: flow based
MPLS forwarding mode: drop
ISO forwarding mode: drop
Tap mode: disabled (default)
Flow trace status
Flow tracing status: off
Flow session distribution
Distribution mode: Hash-based
GTP-U distribution: Disabled
Flow ipsec performance acceleration: off
Flow packet ordering
Ordering mode: Hardware
Flow power mode IPsec: Enabled
Fat core group status: on
```

show security flow status (for hash-based datapath forwarding using SRX5K-MPC3-40G10G (IOC3) and SRX5K-MPC3-100G10G (IOC3))

```
user@host> show security flow status
Flow forwarding mode:
Inet forwarding mode: flow based
Inet6 forwarding mode: flow based
MPLS forwarding mode: drop
ISO forwarding mode: drop
Tap mode: disabled (default)
Flow trace status
Flow tracing status: off
Flow session distribution
Distribution mode: Hash-based
GTP-U distribution: Disabled
Flow ipsec performance acceleration: off
Flow packet ordering
Ordering mode: Hardware
Flow power mode IPsec: Disabled
Fat core group status: on
```

show security flow status (SRX5400, SRX5600, SRX5600, and vSRX Virtual Firewall)

```

user@host> show security flow status
Flow forwarding mode:
Inet forwarding mode: flow based
Inet6 forwarding mode: flow based
MPLS forwarding mode: drop
ISO forwarding mode: drop
Tap mode: enabled, inspect ipip
...

```

show security flow status (Tap mode enabled with IP-IP or GRE tunnel inspection on SRX300, SRX320, SRX340, SRX345, SRX1500, SRX4100, and SRX4200)

```

user@host> show security flow status
Flow forwarding mode:
  Inet forwarding mode: flow based
...
Flow packet ordering
  Ordering mode: Hardware
Flow power mode IPsec: Disabled
Flow Enhanced Service Mode: Enabled
...

```

show security flow status (Enhanced Service Mode enabled on vSRX Virtual Firewall 3.0)

```

user@host> show security flow status
Flow forwarding mode:
  Inet forwarding mode: flow based
  Inet6 forwarding mode: flow based
  MPLS forwarding mode: drop
  ISO forwarding mode: drop
  Tap mode: disabled (default)
Flow trace status
  Flow tracing status: off
Flow session distribution
  Distribution mode: Hash-based
  GTP-U distribution: Disabled
Flow ipsec performance acceleration: off

```

```

Flow packet ordering
  Ordering mode: Hardware
Flow power mode IPsec: Disabled
Flow power mode IPsec QAT: Enabled
Fat core group status: off
Flow inline fpga crypto: Disabled

```

show security flow status (GRE Performance Acceleration)

```

user@host> show security flow status
Flow forwarding mode:
Inet forwarding mode: flow based
Inet6 forwarding mode: drop
MPLS forwarding mode: drop
ISO forwarding mode: drop
TAP mode: enabled
Flow trace status
Flow tracing status: off
Flow session distribution
Distribution mode: RR-based
GTP-U distribution: Enabled Flow packet ordering
Ordering mode: Software (reboot needed to change to software)
Flow power mode IPsec: Disabled
Flow gre performance acceleration: on

```

show security flow status (PowerMode)

```

user@host> show security flow status
node0:
-----
Flow forwarding mode:
  Inet forwarding mode: flow based
  Inet6 forwarding mode: flow based
  MPLS forwarding mode: drop
  ISO forwarding mode: drop
  Tap mode: disabled (default)
Flow trace status
  Flow tracing status: off
Flow session distribution
  Distribution mode: Hash-based

```



```

GTP-U distribution: Disabled
SCTP distribution: Enabled
Flow ipsec performance acceleration: off
Flow gre performance acceleration: off
Flow packet ordering
  Ordering mode: Hardware
Flow power mode: Enabled
Flow power mode IPsec: Enabled
Flow power mode IPsec QAT: Disabled
Fat core group status: on
Flow inline fpga crypto: Disabled

```

show security flow status (PowerMode IPsec QAT)

show security flow status (MX-SPC3 services card)

```

user@host> show security flow status
Flow forwarding mode:
  Inet forwarding mode: flow based
  Inet6 forwarding mode: flow based
  MPLS forwarding mode: drop
  ISO forwarding mode: drop
  Tap mode: disabled (default)
Flow trace status
  Flow tracing status: off
Flow session distribution
  Distribution mode: Hash-based
  GTP-U distribution: Disabled
Flow ipsec performance acceleration: off
Flow packet ordering
  Ordering mode: Hardware
Flow power mode IPsec: Enabled
Fat core group status: on

```

Release Information

Command introduced in Junos OS Release 10.2; session distribution mode option added in Junos OS Release 12.1X44-D10; enhanced route scaling mode option added in Junos OS Release 12.1X45-D10. GTP-U distribution option added in Junos OS Release 15.1X49-D40.

Starting in Junos OS Release 15.1X49-D10 and Junos OS Release 17.3R1, SRX5K-MPC3-100G10G (IOC3) and SRX5K-MPC3-40G10G (IOC3) are introduced for SRX5400, SRX5600, and SRX5800 devices that perform hash-based data path packet forwarding to interconnect with all existing IOC and SPC cards using the XL chip (packet-processing chip).

The IOC3 XL chip uses a hash-based method to distribute ingress traffic to a pool of SPUs by default. Selection of hash keys depends on application protocols.

Starting in Junos OS Release 18.3R1, flow PowerMode IPsec support is introduced on vSRX Virtual Firewall instances.

Starting in Junos OS Release 18.4R1, flow PowerMode IPsec support is introduced on SRX4100 and SRX 4200 devices.

Starting in Junos OS Release 18.2R2, flow PowerMode IPsec support is introduced on SRX5400, SRX5600, and SRX5800 devices.

Starting in Junos OS Release 19.1R1, flow PowerMode IPsec support is introduced on SRX4600 devices.

Starting in Junos OS Release 19.4R1, symmetric fat tunnel support is introduced on SRX5400, SRX5600, SRX5800, and vSRX Virtual Firewall instances.

Starting in Junos OS Release 20.3R1, Enhanced Service Mode is supported on vSRX Virtual Firewall 3.0. In this mode of service vSRX Virtual Firewall 3.0 can support upto 128K L7 service sessions with increased service memory. By default, ESM is disabled and the vSRX Virtual Firewall 3.0 is in basic firewall mode. You can enable ESM using the `set security forwarding-process enhanced-services-mode` command. After enabling this mode, you need to reboot the instance. When you enable this configuration, you will receive a warning message **warning: You have changed enhanced services mode. You must reboot the system for your change to take effect. If you have deployed a cluster, be sure to reboot all nodes.**

Starting in Junos OS Release 20.4R1, the `jexec`, `minimal`, and `root-override` support is introduced on SRX1500, SRX4100, SRX4200, SRX4600, SRX5000 line of devices, and vSRX Virtual Firewall. The options `route`, `session-scan`, and `tunnel` at `[edit security flow traceoptions flag]` hierarchy are configured only by root user.

Starting in Junos OS Release 21.1R1, we support the PMI and GRE acceleration solutions to improve the software-defined WAN (SD-WAN) performance.

For PMI solution, include the `power-mode-ipsec` and `gre-performance-acceleration` statements at the `[edit security flow]` hierarchy level. PMI supports both IPsec and GRE. In this case, traffic flows through the PMI data path.

For GRE acceleration solution, include the `gre-performance-acceleration` statement at the `[edit security flow]` hierarchy level. By default, `gre-performance-acceleration` is turned off. In this case, traffic flows through the GRE acceleration data path.

Starting in Junos OS Release 21.2R1, we support clear text traffic over generic routing encapsulation (GRE) tunnels and MPLS-over-GRE tunnels.

RELATED DOCUMENTATION

[Understanding Traffic Processing on Security Devices | 2](#)

show security forwarding-options mirror-filter

IN THIS SECTION

- [Syntax | 819](#)
- [Description | 820](#)
- [Options | 820](#)
- [Required Privilege Level | 821](#)
- [Output Fields | 821](#)
- [Sample Output | 822](#)
- [Release Information | 822](#)

Syntax

```
show security forwarding-options mirror-filter (all | filter-name)
```

Description

Displays status information about all configured mirror filters or that of a specific mirror filter. Each mirror filter contains a set of parameters against which traffic is matched. For each mirror filter, the output identifies the number of packets that were matched by the filter for mirroring and the number of packets that were sent to the packet analyzer. It also shows the parameters that were configured for the mirror filter.

Network operators need a way to monitor X2 traffic to debug any handover issues across eNodeBs. The mirror filter feature allows you to do that. To use the mirror filter feature to monitor X2 traffic, you configure mirror filters. Traffic coming out of an IPsec tunnel is decrypted, mirrored, and analyzed by a packet analyzer, and then encrypted again to go into the outbound IPsec tunnel.

NOTE: The SRX Series mirror filter feature is bidirectional, much like a session. X2 traffic flowing through an IPsec VPN from devices that match the configured filter conditions is mirrored and analyzed.

Starting in Junos OS Release 18.4R1, if the output X2 interface of a mirror filter is configured for an st0 interface to filter traffic that you want to analyze, the packet is duplicated and encrypted by the IPsec tunnel bound to the st0 interface. This enhancement supports the SRX Series Firewalls to send traffic mirrored from a port on an IPsec tunnel.

You can configure up to 15 different mirror filters to be used concurrently.

NOTE: Although there is no minimum required number of parameters for a mirror filter, please be mindful that if you specify too few criteria or accidentally commit an incomplete filter, an over-proportional amount of traffic flow through the system could be mirrored.

Options

- | | |
|---------------------------|---|
| all | Display counters for all mirror filters. |
| <i>filter-name</i> | Name of the mirror filter for which the counters are displayed. |

Required Privilege Level

view

Output Fields

Lists the output fields for the `show security forward-options mirror-filter` command. Output fields are listed in the approximate order in which they appear in the output.

Table 74: show security forward-options mirror-filter

Field Name	Field Description
mirror-filter-name	Name of the mirror filter configured on the device.
interface-in	Name of the incoming logical interface to be matched for mirroring.
interface-out	Name of the outgoing logical interface to be matched for mirroring.
protocol	Networking protocol name or number to be matched for mirroring.
source-port	Transmission Control Protocol (TCP) or User Datagram Protocol (UDP) source port number to be matched for mirroring.
source-prefix	Source IP prefix or address to be matched for mirroring.
destination-port	Transmission Control Protocol (TCP) or User Datagram Protocol (UDP) destination port number to be matched for mirroring.
destination-prefix	Destination IP prefix or address to be matched for mirroring.
filter-counters	Number of packets matched for mirroring.
output-counter	Number of packets sent to the packet analyzer.

Sample Output

show security forward-options mirror-filter

```
user@host> show security forward-options mirror-filter traffic-https
```

```
Security mirror status
```

```
mirror-filter-name: traffic-https  
interface-in: st0.1  
interface-out: st0.2  
destination-port: 443  
protocol: 132  
source-prefix: 192.0.2.0  
destination-prefix: 203.0.113.0  
filter-counters: 2  
output-counters: 2
```

Release Information

Command introduced in Junos OS Release 12.1X46-D10.

RELATED DOCUMENTATION

[mirror-filter \(Security Forwarding Options\) | 345](#)

[clear security forward-options mirror filter | 488](#)

show security forward-options resource-manager

IN THIS SECTION

● [Syntax | 823](#)

- Description | 823
- Options | 823
- Required Privilege Level | 824
- Output Fields | 824
- Sample Output | 824
- Release Information | 825

Syntax

```
show security forward-options resource-manager settings <node (node-id | all | local | primary)>
```

Description

Display forward option status and the CPU and memory allocated for the advance services and to verify the CPU allocation between routing engine and flow RT threads.

Options

- *setting*—Display resource manager settings
- *node*—(Optional) For chassis cluster configurations, display resource manager settings on a specific node.
 - *node-id*—Identification number of the node. It can be 0 or 1.
 - *all*—Display information about all nodes.
 - *local*—Display information about the local node.
 - *primary*—Display information about the primary node.
- *status*—Verify the CPU allocation between routing engine and flow RT threads.

Required Privilege Level

view

Output Fields

Table 75 on page 824 lists the output fields for the `show security forward-options resource-manager settings` command. Output fields are listed in the approximate order in which they appear.

Table 75: show security forward-options resource-manager settings Output Fields

Field Name	Field Description
Owner	Displays owner of the setting. Usually it is the service that requests the resource. The service utilizing resources such as Content Security, IDP, SWRSS, SWRSS-IO, NICRSS_Q, or RE.
Type	Displays resource type. This can be either CPU core number, CPU core percentage, regular memory, service memory, heap memory, SWRSS mode or value.
Current settings and Next settings	Displays the current effective and next boot effective value. Value “-” indicates that the setting is not effective or takes default value.

Sample Output

`show security forward-options resource-manager status`

```
user@host> show security forward-options resource-manager status
Resource manager details:
vCPU number for IO threads: 0
vCPU number for flow threads: 1
```

show security forward-options resource-manager settings

```
user@host> show security forward-options resource-manager settings
Owner      Type                Current settings  Next settings
RE         CPU core number     1                 1
```

show security forward-options resource-manager status (SRX4600)

```
user@host> show security forward-options resource-manager status
Resource manager details:
vCPU number for IO threads: 0
vCPU number for flow threads: 23
Dedicated resources for logging: Enabled
```

Release Information

Command introduced in Junos OS Release 19.4R1.

RELATED DOCUMENTATION

| [Understanding Traffic Processing on Security Devices | 2](#)

show security monitoring

IN THIS SECTION

- [Syntax | 826](#)
- [Description | 826](#)
- [Required Privilege Level | 826](#)
- [show security monitoring | 826](#)

- [show security monitoring \(SRX1400\) | 827](#)
- [show security monitoring \(vSRX Virtual Firewall\) | 827](#)
- [show security monitoring \(vSRX Virtual Firewall in a Chassis Cluster\) | 828](#)
- [Release Information | 828](#)

Syntax

```
show security monitoring
```

Description

Displays a count of security flow and central point (CP) sessions, CPU utilization (as a percentage of maximum), and memory in use (also as a percentage of maximum) at the moment the command is run. This command is supported on SRX1400, SRX1500, SRX5400, SRX5600, and SRX5800 devices and vSRX Virtual Firewall.

Required Privilege Level

View

show security monitoring

command-name

```
user@host>show security monitoring
```

```
user@host> show security monitoring
-----
                Flow session  Flow session  CP session  CP session
```

FPC	PIC	CPU	Mem	current	maximum	current	maximum
1	0	0	11	0	0	0	0
1	1	0	5	3	6291456	1	7549747
1	2	0	5	2	6291456	0	7549747
1	3	0	5	3	6291456	1	7549747
8	0	0	65	4	6963	2	8355
8	1	0	65	2	6963	0	8355
Total Sessions:				14	18888294	4	22665951

show security monitoring (SRX1400)

command-name

user@host>show security monitoring

```
user@host> show security monitoring
```

FPC	PIC	CPU	Mem	Flow session current	Flow session maximum	CP session current	CP session maximum
1	0	0	75	0	1048576	0	1048576

show security monitoring (vSRX Virtual Firewall)

command-name

user@host>show security monitoring

```
user@host> show security monitoring
```

FPC	PIC	CPU	Mem	Flow session current	Flow session maximum	CP session current	CP session maximum
-----	-----	-----	-----	-------------------------	-------------------------	-----------------------	-----------------------

```
-----
0 0 0 68          2          524288          N/A          N/A
```

show security monitoring (vSRX Virtual Firewall in a Chassis Cluster)

command-name

user@host>show security monitoring

node0:

```
-----
                Flow session  Flow session  CP session  CP session
FPC PIC CPU Mem      current    maximum      current    maximum
-----
0 0 0 67          0          524288          N/A          N/A
```

node1:

```
-----
                Flow session  Flow session  CP session  CP session
FPC PIC CPU Mem      current    maximum      current    maximum
-----
0 0 0 67          0          524288          N/A          N/A
```

Release Information

Command introduced in Junos OS Release 10.2.

RELATED DOCUMENTATION

No Link Title

No Link Title

No Link Title

show security np-cache summary

IN THIS SECTION

- [Syntax | 829](#)
- [Description | 829](#)
- [Required Privilege Level | 829](#)
- [Output Fields | 830](#)
- [Sample Output | 830](#)
- [Sample Output | 830](#)
- [Release Information | 831](#)

Syntax

```
show security np-cache summary
```

Description

This command is supported on the SRX4600, SRX5400, SRX5600, and SRX5800 devices. This command shows the IOC NP session cache information.

Required Privilege Level

view

Output Fields

Table 76 on page 830 lists the output fields for the `show security flow cp-session` command. Output fields are listed in the approximate order in which they appear.

Table 76: show security flow cp-session Output Fields

Field Name	Field Description
NP-cache/services-offload Wings	Number of wings used (a wing is one half or direction of a session),
NP-cache Capacity	Capacity of the NP in number of wings.
NP-cache Usage	Percentage of wings used.

Sample Output

show security np-cache summary (SRX4600)

```
user@host> show security np-cache summary
NP-cache/services-offload Wings: 10
  NP-cache Capacity: 5242880
  NP-cache Usage: 0%
2
```

Sample Output

show security np-cache summary (SRX5400, SRX5600, and SRX5800)

```
user@host> show security np-cache summary
  IO Card NP cache usage of FPC9:
  PIC0
```

```
NP-cache/services-offload Wings: 0
NP-cache Capacity: 5242880
NP-cache Usage: 0%
PIC1
NP-cache/services-offload Wings: 0
NP-cache Capacity: 5242880
NP-cache Usage: 0%
```

Release Information

Command introduced in Junos OS Release 21.2 R1.

show security policies

IN THIS SECTION

- [Syntax | 831](#)
- [Description | 832](#)
- [Options | 832](#)
- [Required Privilege Level | 833](#)
- [Output Fields | 833](#)
- [Sample Output | 839](#)
- [Release Information | 854](#)

Syntax

```
show security policies
<all-logical-systems-tenants>
<checksum>
<count>
```

```

<detail>
<from-zone zone-name>
<global>
<hit-count>
<information>
<logical-system logical-system-name>
<policy-name policy-name>
<root-logical-system>
<service-set>
<start>
<tenant tenant-name>
<to-zone zone-name>
<unknown-source-identity>
<zone-context>

```

Description

Displays a summary of all security policies configured on the device. If a particular policy is specified, display information specific to that policy. The existing show commands for displaying the policies configured with multiple tenant support are enhanced. A security policy controls the traffic flow from one zone to another zone. The security policies allow you to deny, permit, reject (deny and send a TCP RST or ICMP port unreachable message to the source host), encrypt and decrypt, authenticate, prioritize, schedule, filter, and monitor the traffic attempting to cross from one security zone to another.

Options

- `all-logical-systems-tenants`—Displays all multitenancy systems.
- `checksum`—Displays the policy information checksum.
- `count`—Displays the number of policies to show. Range is 1 through 65,535.
- `detail`—(Optional) Displays a detailed view of all of the policies configured on the device.
- `from-zone`—Displays the policy information matching the given source zone.
- `global`—(Optional) Displays the policy information about global policies.
- `hit-count`—Displays the policies hit count.

- `information`—Displays the policy information.
- `logical-system`—Displays the logical system name.
- `policy-name`—(Optional) Displays the policy information matching the given policy name.
- `root-logical-system`—Displays root logical system as default.
- `service-set`—Displays the name of the service set.
- `start`—Displays the policies from a given position. Range is 1 through 65,535.
- `tenant`—Displays the name of the tenant system.
- `to-zone`—Displays the policy information matching the given destination zone.
- `unknown-source-identity`—Displays the unknown-source-identity of a policy.
- `zone-context`—Displays the count of policies in each context (from-zone and to-zone).

Required Privilege Level

view

Output Fields

[Table 77 on page 833](#) lists the output fields for the `show security policies` command. Output fields are listed in the approximate order in which they appear.

Table 77: show security policies Output Fields

Field Name	Field Description
From zone	Name of the source zone.
To zone	Name of the destination zone.
Policy-name	Name of the applicable policy.

Table 77: show security policies Output Fields (Continued)

Field Name	Field Description
Description	Description of the applicable policy.
State	<p>Status of the policy:</p> <ul style="list-style-type: none"> enabled: The policy can be used in the policy lookup process, which determines access rights for a packet and the action taken in regard to it. disabled: The policy cannot be used in the policy lookup process, and therefore it is not available for access control.
Index	Internal number associated with the policy.
Sequence number	Number of the policy within a given context. For example, three policies that are applicable in a from-zoneA-to-zoneB context might be ordered with sequence numbers 1, 2, 3. Also, in a from-zoneC-to-zoneD context, four policies might have sequence numbers 1, 2, 3, 4.
Source addresses	<p>For standard display mode, the names of the source addresses for a policy. Address sets are resolved to their individual names.</p> <p>For detail display mode, the names and corresponding IP addresses of the source addresses for a policy. Address sets are resolved to their individual address name-IP address pairs.</p>
Destination addresses	Name of the destination address (or address set) as it was entered in the destination zone's address book. A packet's destination address must match this value for the policy to apply to it.
source-end-user-profile	Name of the device identity profile (referred to as end-user-profile in the CLI) that contains attributes, or characteristics of a device. Specification of the device identity profile in the source-end-user-profile field is part of the device identity feature. If a device matches the attributes specified in the profile and other security policy parameters, then the security policy's action is applied to traffic issuing from the device.
Source addresses (excluded)	Name of the source address excluded from the policy.

Table 77: show security policies Output Fields (Continued)

Field Name	Field Description
Destination addresses (excluded)	Name of the destination address excluded from the policy.
Source identities	One or more user roles specified for a policy.
Applications	<p>Name of a preconfigured or custom application whose type the packet matches, as specified at configuration time.</p> <ul style="list-style-type: none"> • IP protocol: The Internet protocol used by the application—for example, TCP, UDP, ICMP. • ALG: If an ALG is explicitly associated with the policy, the name of the ALG is displayed. If application-protocol ignore is configured, ignore is displayed. Otherwise, 0 is displayed. <p>However, even if this command shows ALG: 0, ALGs might be triggered for packets destined to well-known ports on which ALGs are listening, unless ALGs are explicitly disabled or when application-protocol ignore is not configured for custom applications.</p> <ul style="list-style-type: none"> • Inactivity timeout: Elapsed time without activity after which the application is terminated. • Source port range: The low-high source port range for the session application.
Source identity feeds	Name of a source identity (user name) added as match criteria
Destination identity feeds	Name of a destination identity (user name) added as match criteria
Dynamic Applications	Application identification-based Layer 7 dynamic applications.

Table 77: show security policies Output Fields (Continued)

Field Name	Field Description
Destination Address Translation	<p>Status of the destination address translation traffic:</p> <ul style="list-style-type: none"> • drop translated—Drop the packets with translated destination addresses. • drop untranslated—Drop the packets without translated destination addresses.
Application Firewall	<p>An application firewall includes the following:</p> <ul style="list-style-type: none"> • Rule-set—Name of the rule set. • Rule—Name of the rule. <ul style="list-style-type: none"> • Dynamic applications—Name of the applications. • Dynamic application groups—Name of the application groups. • Action—The action taken with respect to a packet that matches the application firewall rule set. Actions include the following: <ul style="list-style-type: none"> • permit • deny • Default rule—The default rule applied when the identified application is not specified in any rules of the rule set.

Table 77: show security policies Output Fields (Continued)

Field Name	Field Description
Action or Action-type	<ul style="list-style-type: none"> • The action taken for a packet that matches the policy's tuples. Actions include the following: <ul style="list-style-type: none"> • permit • feed • firewall-authentication • tunnel ipsec-vpn <i>vpn-name</i> • pair-policy <i>pair-policy-name</i> • source-nat pool <i>pool-name</i> • pool-set <i>pool-set-name</i> • interface • destination-nat <i>name</i> • deny • reject • services-offload
Session log	Session log entry that indicates whether the at-create and at-close flags were set at configuration time to log session information.
Scheduler name	Name of a preconfigured scheduler whose schedule determines when the policy is active and can be used as a possible match for traffic.

Table 77: show security policies Output Fields (*Continued*)

Field Name	Field Description
Policy statistics	<ul style="list-style-type: none"> • Input bytes—The total number of bytes presented for processing by the device. • Initial direction—The number of bytes presented for processing by the device from the initial direction. • Reply direction—The number of bytes presented for processing by the device from the reply direction. • Output bytes—The total number of bytes actually processed by the device. • Initial direction—The number of bytes from the initial direction actually processed by the device. • Reply direction—The number of bytes from the reply direction actually processed by the device. • Input packets—The total number of packets presented for processing by the device. • Initial direction—The number of packets presented for processing by the device from the initial direction. • Reply direction—The number of packets presented for processing by the device from the reply direction. • Output packets—The total number of packets actually processed by the device. • Initial direction—The number of packets actually processed by the device from the initial direction. • Reply direction—The number of packets actually processed by the device from the reply direction. • Session rate—The total number of active and deleted sessions. • Active sessions—The number of sessions currently present because of access control lookups that used this policy. • Session deletions—The number of sessions deleted since system startup. • Policy lookups—The number of times the policy was accessed to check for a match.

Table 77: show security policies Output Fields (Continued)

Field Name	Field Description
dynapp-redir-profile	Displays unified policy redirect profile. See <i>profile(dynamic-application)</i> .
Per policy TCP Options	Configured syn and sequence checks, and the configured TCP MSS value for the initial direction, the reverse direction or, both.
Feed	Feeds details added in the security policy. The supported feeds are: <ul style="list-style-type: none"> • add-source-ip-to-feed • add-destination-ip-to-feed • add-source-identity-to-feed • add-destination-identity-to-feed

Sample Output

show security policies

```

user@host> show security policies

From zone: trust, To zone: untrust
Policy: p1, State: enabled, Index: 4, Sequence number: 1
Source addresses:
sa-1-ipv4: 198.51.100.11/24
sa-2-ipv6: 2001:db8:a0b:12f0::1/32
sa-3-ipv6: 2001:db8:a0b:12f0::22/32
sa-4-wc: 203.0.113.1/255.255.0.255
Destination addresses:
da-1-ipv4: 10.2.2.2/24
da-2-ipv6: 2001:db8:a0b:12f0::8/32
da-3-ipv6: 2001:db8:a0b:12f0::9/32
da-4-wc: 192.168.22.11/255.255.0.255
Source identities: role1, role2, role4
Applications: any

```

```

Action: permit, application services, log, scheduled
Application firewall : my_ruleset1
Policy: p2, State: enabled, Index: 5, Sequence number: 2
Source addresses:
sa-1-ipv4: 198.51.100.11/24
sa-2-ipv6: 2001:db8:a0b:12f0::1/32
sa-3-ipv6: 2001:db8:a0b:12f0::22/32
Destination addresses:
da-1-ipv4: 10.2.2.2/24
da-2-ipv6: 2001:db8:a0b:12f0::1/32
da-3-ipv6: 2001:db8:a0b:12f0::9/32
Source identities: role1, role4
Applications: any
Action: deny, scheduled

```

show security policies (Dynamic Applications)

```
user@host>show security policies
```

```

Policy: p1, State: enabled, Index: 4, Scope Policy: 0, Sequence number: 1
Source addresses: any
Destination addresses: any
Applications: any
Dynamic Applications: junos:YAHOO
Action: deny, log
Policy: p2, State: enabled, Index: 5, Scope Policy: 0, Sequence number: 2
Source addresses: any
Destination addresses: any
Applications: any
Dynamic Applications: junos:web, junos:web:social-networking:facebook,
junos:TFTP, junos:QQ
Action: permit, log
Policy: p3, State: enabled, Index: 6, Scope Policy: 0, Sequence number: 3
Source addresses: any
Destination addresses: any
Applications: any
Dynamic Applications: junos:HTTP, junos:SSL
Action: permit, application services, log

```

The following example displays the output with unified policies configured.

```
user@host> show security policies

Default policy: deny-all
Pre ID default policy: permit-all
From zone: trust, To zone: untrust
  Policy: p2, State: enabled, Index: 4, Scope Policy: 0, Sequence number: 1
    Source addresses: any
    Destination addresses: any
    Applications: junos-defaults
    Dynamic Applications: junos:GMAIL, junos:FACEBOOK-CHAT
    dynapp-redir-profile: profile1
```

show security policies policy-name p2

```
user@host> show security policies policy-name p2
  Policy: p2, State: enabled, Index: 4, Scope Policy: 0, Sequence number: 1
    From zones: any
    To zones: any
    Source vrf group: any
    Destination vrf group: any
    Source addresses: any
    Destination addresses: any
    Applications: any
    Dynamic Applications: any
    Action: permit, application services, feed
```

show security policies policy-name detail

```
user@host> show security policies policy-name p2 detail

Policy: p2, action-type: permit, State: enabled, Index: 4, Scope Policy: 0
  Policy Type: Configured, global
  Sequence number: 1
  From zones:
    any
  To zones:
    any
```

```

Source vrf group:
  any
Destination vrf group:
  any
Source addresses:
  any-ipv4(global): 0.0.0.0/0
  any-ipv6(global): ::/0
Destination addresses:
  any-ipv4(global): 0.0.0.0/0
  any-ipv6(global): ::/0
Application: any
  IP protocol: 0, ALG: 0, Inactivity timeout: 0
  Source port range: [0-0]
  Destination ports: [0-0]
Dynamic Application:
  any: 0
Per policy TCP Options: SYN check: No, SEQ check: No, Window scale: No
Intrusion Detection and Prevention: disabled
Unified Access Control: disabled
Feed: add-source-ip-to-feed

```

```
user@host> show security policies policy-name p1 detail
```

```

Policy: p1, action-type: permit, State: enabled, Index: 4, Scope Policy: 0
Description: The policy p1 is for the sales team
Sequence number: 1
From zone: trust, To zone: untrust
Source addresses:
  sa-1-ipv4: 198.51.100.11/24
  sa-2-ipv6: 2001:db8:a0b:12f0::1/32
  sa-3-ipv6: 2001:db8:a0b:12f0::9/32
  sa-4-wc: 203.0.113.1/255.255.0.255
Destination addresses:
  da-1-ipv4: 192.0.2.0/24
  da-2-ipv6: 2001:db8:a0b:12f0::1/32
  da-3-ipv6: 2001:db8:a0b:12f0::9/32
  da-4-wc: 192.168.22.11/255.255.0.255
Source identities:
  role1
  role2
  role4
Application: any
  IP protocol: 0, ALG: 0, Inactivity timeout: 0

```

```

Source port range: [0-0]
Destination port range: [0-0]
Destination Address Translation: drop translated
Application firewall :
  Rule-set: my_ruleset1
    Rule: rule1
      Dynamic Applications: junos:FACEBOOK-ACCESS, junos:YMSG
      Dynamic Application groups: junos:web, junos:chat
      Action: deny
    Default rule: permit
Session log: at-create, at-close
Scheduler name: sch20
Per policy TCP Options: SYN check: No, SEQ check: No
Policy statistics:
  Input bytes      :                18144          545 bps
    Initial direction:                9072           272 bps
    Reply direction :                9072           272 bps
  Output bytes     :                18144          545 bps
    Initial direction:                9072           272 bps
    Reply direction :                9072           272 bps
  Input packets   :                 216             6 pps
    Initial direction:                 108             3 bps
    Reply direction :                 108             3 bps
  Output packets  :                 216             6 pps
    Initial direction:                 108             3 bps
    Reply direction :                 108             3 bps
  Session rate    :                 108             3 sps
  Active sessions :                   93
  Session deletions :                   15
  Policy lookups  :                   108

```

show security policies (Services-Offload)

```

user@host> show security policies

Policy: p1, action-type: reject, State: enabled, Index: 4, Scope Policy: 0
Policy Type: Configured
Sequence number: 1
From zone: trust, To zone: trust
Source addresses:
  any-ipv4(global): 0.0.0.0/0

```

```

any-ipv6(global): ::/0
Destination addresses:
any-ipv4(global): 0.0.0.0/0
any-ipv6(global): ::/0
Application: any
IP protocol: 0, ALG: 0, Inactivity timeout: 0
Source port range: [0-0]
Destination port range: [0-0]
dynapp-redir-profile: profile1(1)
Per policy TCP Options: SYN check: No, SEQ check: No, Window scale: No

```

show security policies (Device Identity)

```

user@host> show security policies
From zone: trust, To zone: untrust
Policy: dev-id-marketing, State: enabled, Index: 5, Scope Policy: 0, Sequence number: 1
Source addresses: any
Destination addresses: any
source-end-user-profile: marketing-profile
Applications: any
Action: permit

```

show security policies detail

```

user@host> show security policies detail

Default policy: deny-all
Policy: p1, action-type: permit, services-offload:enabled , State: enabled, Index: 4, Scope
Policy: 0
Policy Type: Configured
Description: The policy p1 is for the sales team
Sequence number: 1
From zone: trust, To zone: untrust
Source addresses:
any-ipv4(global): 0.0.0.0/0
any-ipv6(global): ::/0
Destination addresses:
any-ipv4(global): 0.0.0.0/0
any-ipv6(global): ::/0
Source identities:

```

```

    role1
    role2
    role4
Application: any
  IP protocol: 0, ALG: 0, Inactivity timeout: 0
    Source port range: [0-0]
    Destination port range: [0-0]
Per policy TCP Options: SYN check: No, SEQ check: No
Policy statistics:
  Input bytes      :                18144          545 bps
    Initial direction:                9072          272 bps
    Reply direction :                9072          272 bps
  Output bytes     :                18144          545 bps
    Initial direction:                9072          272 bps
    Reply direction :                9072          272 bps
  Input packets   :                 216           6 pps
    Initial direction:                 108           3 bps
    Reply direction :                 108           3 bps
  Output packets  :                 216           6 pps
    Initial direction:                 108           3 bps
    Reply direction :                 108           3 bps
  Session rate    :                 108           3 sps
  Active sessions :                   93
  Session deletions :                   15
  Policy lookups  :                   108

Policy: p2, action-type: permit, services-offload:enabled , State: enabled, Index: 5, Scope
Policy: 0
  Policy Type: Configured
  Description: The policy p2 is for the sales team
  Sequence number: 1
  From zone: untrust, To zone: trust
  Source addresses:
    any-ipv4(global): 0.0.0.0/0
    any-ipv6(global): ::/0
  Destination addresses:
    any-ipv4(global): 0.0.0.0/0
    any-ipv6(global): ::/0
  Source identities:
    role1
    role2
    role4
Application: any
  IP protocol: 0, ALG: 0, Inactivity timeout: 0

```

```

Source port range: [0-0]
Destination port range: [0-0]
Per policy TCP Options: SYN check: No, SEQ check: No

```

The following example displays the output with unified policies configured.

```

user@host> show security policies detail

Default policy: deny-all
Pre ID default policy: permit-all
Policy: p2, action-type: reject, State: enabled, Index: 4, Scope Policy: 0
Policy Type: Configured
Sequence number: 1
From zone: trust, To zone: untrust
Source addresses:
  any-ipv4(global): 0.0.0.0/0
  any-ipv6(global): ::/0
Destination addresses:
  any-ipv4(global): 0.0.0.0/0
  any-ipv6(global): ::/0
Application: junos-defaults
IP protocol: 6, ALG: 0, Inactivity timeout: 1800
  Source port range: [0-0]
  Destination port range: [443-443]
IP protocol: 6, ALG: 0, Inactivity timeout: 1800
  Source port range: [0-0]
  Destination port range: [5432-5432]
IP protocol: 6, ALG: 0, Inactivity timeout: 1800
  Source port range: [0-0]
  Destination port range: [80-80]
IP protocol: 6, ALG: 0, Inactivity timeout: 1800
  Source port range: [0-0]
  Destination port range: [3128-3128]
IP protocol: 6, ALG: 0, Inactivity timeout: 1800
  Source port range: [0-0]
  Destination port range: [8000-8000]
IP protocol: 6, ALG: 0, Inactivity timeout: 1800
  Source port range: [0-0]
  Destination port range: [8080-8080]
IP protocol: 17, ALG: 0, Inactivity timeout: 60
  Source port range: [0-0]
  Destination port range: [1-65535]

```

```

IP protocol: 6, ALG: 0, Inactivity timeout: 1800
  Source port range: [0-0]
  Destination port range: [443-443]
IP protocol: 6, ALG: 0, Inactivity timeout: 1800
  Source port range: [0-0]
  Destination port range: [5432-5432]
IP protocol: 6, ALG: 0, Inactivity timeout: 1800
  Source port range: [0-0]
  Destination port range: [80-80]
IP protocol: 6, ALG: 0, Inactivity timeout: 1800
  Source port range: [0-0]
  Destination port range: [3128-3128]
IP protocol: 6, ALG: 0, Inactivity timeout: 1800
  Source port range: [0-0]
  Destination port range: [8000-8000]
IP protocol: 6, ALG: 0, Inactivity timeout: 1800
  Source port range: [0-0]
  Destination port range: [8080-8080]
IP protocol: 17, ALG: 0, Inactivity timeout: 60
  Source port range: [0-0]
  Destination port range: [1-65535]
Dynamic Application:
  junos:FACEBOOK-CHAT: 10704
  junos:GMAIL: 51
dynapp-redir-profile: profile1(1)
Per policy TCP Options: SYN check: No, SEQ check: No, Window scale: No

```

show security policies detail (TCP Options)

```

user@host> show security policies policy-name p2 detail
node0:
-----
Policy:p2, action-type:permit, State: enabled,Index: 4, Scope Policy: 0
Policy Type: Configured
Sequence number: 1
From zone: trust, To zone: trust
Source addresses:
  any-ipv4(global): 0.0.0.0/0
  any-ipv6(global): ::/0
Destination addresses:
  any-ipv4(global): 0.0.0.0/0

```

```

any-ipv6(global): ::/0
Application: junos-defaults
IP protocol: tcp, ALG: 0, Inactivity timeout: 0
Source port range: [0-0]
Destination port range: [80-80]
Per policy TCP Options: SYN check: No, SEQ check: No, Window scale: No
Dynamic-application: junos:HTTP

```

show security policies policy-name (Negated Address)

```

user@host> show security policies policy-name p1
node0:
-----
From zone: trust, To zone: untrust
Policy: p1, State: enabled, Index: 4, Scope Policy: 0, Sequence number: 1
Source addresses(excluded): as1
Destination addresses(excluded): as2
Applications: any
Action: permit

```

show security policies policy-name detail (Negated Address)

```

user@host> show security policies policy-name p1 detail
node0:
-----
Policy: p1, action-type: permit, State: enabled, Index: 4, Scope Policy: 0
Policy Type: Configured
Sequence number: 1
From zone: trust, To zone: untrust
Source addresses(excluded):
  ad1(ad): 255.255.255.255/32
  ad2(ad): 198.51.100.1/24
  ad3(ad): 198.51.100.6 ~ 198.51.100.56
  ad4(ad): 192.0.2.8/24
  ad5(ad): 198.51.100.99 ~ 198.51.100.199
  ad6(ad): 203.0.113.9/24
  ad7(ad): 203.0.113.23/24
Destination addresses(excluded):
  ad13(ad2): 198.51.100.76/24
  ad12(ad2): 198.51.100.88/24

```



```

ad11(ad2): 192.0.2.23 ~ 192.0.2.66
ad10(ad2): 192.0.2.93
ad9(ad2): 203.0.113.76 ~ 203.0.113.106
ad8(ad2): 203.0.113.199
Application: any
IP protocol: 0, ALG: 0, Inactivity timeout: 0
Source port range: [0-0]
Destination port range: [0-0]
Per policy TCP Options: SYN check: No, SEQ check: No

```

show security policies global

```

user@host> show security policies global policy-name Pa
node0:
-----
Global policies:
Policy: Pa, State: enabled, Index: 6, Scope Policy: 0, Sequence number: 1
From zones: any
To zones: any
Source addresses: H0
Destination addresses: H1
Applications: junos-http
Action: permit

```

show security policies detail tenant

```

user@host> show security policies detail tenant TN1

Default policy: deny-all
Pre ID default policy: permit-all
Policy: p1, action-type: permit, State: enabled, Index: 4, Scope Policy: 0
Policy Type: Configured
Sequence number: 1
From zone: trust, To zone: untrust
Source addresses: any
Destination addresses: any
Application: junos-ping
IP protocol: 1, ALG: 0, Inactivity timeout: 60
ICMP Information: type=255, code=0

```

```

Application: junos-telnet
IP protocol: tcp, ALG: 0, Inactivity timeout: 1800
Source port range: [0-0]
Destination port range: [23-23]
Application: app_udp
IP protocol: udp, ALG: 0, Inactivity timeout: 1800
Source port range: [0-0]
Destination port range: [5000-5000]
Application: junos-icmp6-all
IP protocol: 58, ALG: 0, Inactivity timeout: 60
ICMP Information: type=255, code=0
Per policy TCP Options: SYN check: No, SEQ check: No, Window scale: No
Session log: at-create, at-close
Policy statistics:
Input bytes      :                0                0 bps
Initial direction:                0                0 bps
Reply direction  :                0                0 bps
Output bytes     :                0                0 bps
Initial direction:                0                0 bps
Reply direction  :                0                0 bps
Input packets    :                0                0 pps
Initial direction:                0                0 bps
Reply direction  :                0                0 bps
Output packets   :                0                0 pps
Initial direction:                0                0 bps
Reply direction  :                0                0 bps
Session rate     :                0                0 sps
Active sessions  :                0
Session deletions:                0
Policy lookups   :                0

```

show security policies (threat profile feeds)

```

user@host> show security policies policy-name p2
From zone: trust, To zone: untrust
  Policy: p2, State: enabled, Index: 5, Scope Policy: 0, Sequence number: 2
    Source vrf group: any
    Destination vrf group: any
    Source addresses: any
    Destination addresses: any

```

```

Applications: any
Source identity feeds: user_feed_1, user_feed_2
Destination identity feeds: user_feed_3, user_feed_4
Action: permit, application services, feed

```

show security policies detail (threat profile feeds)

```

user@host> show security policies policy-name p2 detail
Policy: p2, action-type: permit, State: enabled, Index: 5, Scope Policy: 0
  Policy Type: Configured
  Sequence number: 2
  From zone: trust, To zone: untrust
  Source vrf group:
    any
  Destination vrf group:
    any
  Source addresses:
    any-ipv4(bob_addrbook_1): 0.0.0.0/0
    any-ipv6(bob_addrbook_1): ::/0
  Destination addresses:
    any-ipv4(bob_addrbook_1): 0.0.0.0/0
    any-ipv6(bob_addrbook_1): ::/0
  Application: any
    IP protocol: 0, ALG: 0, Inactivity timeout: 0
    Source port range: [0-0]
    Destination ports: [0-0]
  Source identity feeds:
user_feed_1
user_feed_2
  Destination identity feeds:
user_feed_3
user_feed_4
  Per policy TCP Options: SYN check: No, SEQ check: No, Window scale: No
  Intrusion Detection and Prevention: disabled
  Unified Access Control: disabled
  Feed: add-source-ip-to-feed
  Feed: add-destination-ip-to-feed
  Feed: add-source-identity-to-feed
  Feed: add-destination-identity-to-feed

```

show security policies detail (services-offload enabled)

```

user@host> show security policies detail
Default policy: deny-all
Default policy log Profile ID: 0
Pre ID default policy: permit-all
Policy: SOF-enable, action-type: permit, services-offload:enabled , State: enabled, Index: 5,
Scope Policy: 0
Policy Type: Configured
Sequence number: 1
From zone: trust, To zone: untrust1
Source vrf group:
any
Destination vrf group:
any
Source addresses:
any-ipv4(global): 0.0.0.0/0
any-ipv6(global): ::/0
Destination addresses:
any-ipv4(global): 0.0.0.0/0
any-ipv6(global): ::/0
Application: any
IP protocol: 0, ALG: 0, Inactivity timeout: 0
Source port range: [0-0]
Destination ports: [0-0]
Dynamic Application:
any: 0
Source identity feeds:
any
Destination identity feeds:
any
Per policy TCP Options: SYN check: No, SEQ check: No, Window scale: No

```

show security policies policy-name SOF-enable

```

user@host> show security policies policy-name SOF-enable
From zone: trust, To zone: untrust1
Policy: SOF-enable, State: enabled, Index: 5, Scope Policy: 0, Sequence number: 1, Log Profile
ID: 0
Source vrf group: any

```

```

Destination vrf group: any
Source addresses: any
Destination addresses: any
Applications: any
Dynamic Applications: any
Source identity feeds: any
Destination identity feeds: any
Action: permit, services-offload

```

show security policies detail (services-offload disabled)

```

user@host> show security policies detail
Default policy: deny-all
Default policy log Profile ID: 0
Pre ID default policy: permit-all
Policy: SOF-disable, action-type: permit, services-offload:disabled , State: enabled, Index: 5,
Scope Policy: 0
  Policy Type: Configured
  Sequence number: 1
  From zone: trust, To zone: untrust1
  Source vrf group:
    any
  Destination vrf group:
    any
  Source addresses:
    any-ipv4(global): 0.0.0.0/0
    any-ipv6(global): ::/0
  Destination addresses:
    any-ipv4(global): 0.0.0.0/0
    any-ipv6(global): ::/0
  Application: any
    IP protocol: 0, ALG: 0, Inactivity timeout: 0
    Source port range: [0-0]
    Destination ports: [0-0]
  Dynamic Application:
    any: 0
  Source identity feeds:
    any
  Destination identity feeds:

```

any

Per policy TCP Options: SYN check: No, SEQ check: No, Window scale: No

show security policies policy-name SOF-disable

```

user@host> show security policies policy-name SOF-disable
From zone: trust, To zone: untrust1
Policy: SOF-disable, State: enabled, Index: 5, Scope Policy: 0, Sequence number: 1, Log
Profile ID: 0
  Source vrf group: any
  Destination vrf group: any
  Source addresses: any
  Destination addresses: any
  Applications: any
  Dynamic Applications: any
  Source identity feeds: any
  Destination identity feeds: any
  Action: permit, no-services-offload

```

Release Information

Command modified in Junos OS Release 9.2.

Support for IPv6 addresses is added in Junos OS Release 10.2.

Support for wildcard addresses is added in Junos OS Release 11.1.

Support for global policy and services offloading is added in Junos OS Release 11.4.

Support for source-identities and the Description output field is added in Junos OS Release 12.1.

Support for negated address added in Junos OS Release 12.1X45-D10.

The output fields for Policy Statistics expanded, and the output fields for the global and policy-name options are expanded to include from-zone and to-zone global match criteria in Junos OS Release 12.1X47-D10.

Support for the initial-tcp-mss and reverse-tcp-mss options is added in Junos OS Release 12.3X48-D20.

Output field and description for source-end-user-profile option is added in Junos OS Release 15.1x49-D70.

Output field and description for `dynamic-applications` option is added in Junos OS Release 15.1x49-D100.

Output field and description for `dynapp-redir-profile` option is added in Junos OS Release 18.2R1.

The `tenant` option is introduced in Junos OS Release 18.3R1.

The `<all-logical-systems-tenants>` option is introduced in Junos OS Release 18.4R1.

The `information` option is introduced in Junos OS Release 18.4R1.

The `checksum` option is introduced in Junos OS Release 18.4R1.

RELATED DOCUMENTATION

Security Policies Overview

Understanding Security Policy Rules

Understanding Security Policy Elements

Unified Policies Configuration Overview

show security policies hit-count

IN THIS SECTION

- [Syntax | 856](#)
- [Description | 856](#)
- [Options | 857](#)
- [Required Privilege Level | 857](#)
- [Output Fields | 858](#)
- [Sample Output | 859](#)
- [Sample Output | 859](#)
- [Sample Output | 859](#)
- [Sample Output | 860](#)
- [Sample Output | 860](#)
- [Sample Output | 860](#)
- [Sample Output | 861](#)

- [Sample Output | 861](#)
- [Release Information | 861](#)

Syntax

```
show security policies hit-count
<ascending>
<descending>
<dynamic-applications>
<from-zone zone-name>
<greater-than count>
<less-than count>
<logical-system (logical-system-name / all)>
<root-logical-system>
<tenant (tenant-name / all)>
<to-zone zone-name>
<url-categories>
```

Description

Display the utility rate of security policies by listing the number of times a security policy rule matches the traffic (number of hits). You can specify the options to list the output in ascending or descending order. You can specify the range to display security policies with certain number of hits. You can filter the output by zones, logical or tenant systems, dynamic applications, and URL categories.

When the device is operating in chassis cluster mode, the count displayed is a sum of all the Services Processing Cards (SPC) hit counts in the cluster setup. The security device retains the count if a Packet Forwarding Engine (PFE) in a node is in failover mode, but does not reboot. . The device clears the count if a node reboots and the PFE in the node also reboots. During an in-service software upgrade (ISSU), all PFEs reboot, therefore all counters are cleared.

Use this command without options to display the number of hits in random order for all security policies and for all zones.

Options

- `ascending`—(Optional) Displays the number of hits for security policies in ascending order.
- `descending`—(Optional) Displays the number of hits for security policies in descending order.
- `dynamic-applications`—(Optional) Displays the number of hits for security policies configured with dynamic applications.

When you display the policy count for the dynamic applications, the device considers the count for the final matched application identification. For example, if the traffic's classification path is: HTTP:FACEBOOK-ACCESS:FACEBOOK-CHAT, then the count increases only for FACEBOOK-CHAT.

- `from-zone zone-name`—(Optional) Displays the number of hits for security policies associated with the named source zone.
- `greater-than count`—(Optional) Displays security policies for which the number of hits is greater than the specified number.

Range: 0 through 4,294,967,295

- `less-than count`—(Optional) Displays security policies for which the number of hits is less than the specified number.

Range: 0 through 4,294,967,295

- `logical-system`—Displays the logical system name.
- `root-logical-system`—Displays the number of hits for security policies configured for a root logical system.
- `tenant`—Displays the number of hits for security policies configured for the tenant system.
- `to-zone zone-name`—(Optional) Displays the number of hits for security policies associated with the named destination zone.
- `url-categories`—(Optional) Displays the number of hits for security policies based on the matching URL categories.

Required Privilege Level

view

Output Fields

"No Link Title" on page 858 lists the output fields for the `show security policies hit-count` command. Output fields are listed in the approximate order in which they appear.

`show security policies hit-count` Output Fields

Field Name	Field Description
index	Displays the line number
from-zone	Name of the source zone
to-zone	Name of the destination zone
name	Name of the security policy
policy count	Number of hits for each security policy
tenant	Displays the name of the tenant system.
Action	Policy action - Permit or Deny.
Redirect	Number of permitted sessions that are redirected by the policy
Dynamic-applications	Details of the dynamic applications. <ul style="list-style-type: none"> • Name - Dynamic-application name • Count- Number of hits for each dynamic application
url-categories	Details of the URL categories. <ul style="list-style-type: none"> • Name - URL category name • Count- Number of hits for each URL category

Sample Output

show security policies hit-count

```
user@host> show security policies hit-count
index  from zone  to zone  name      policy count
  1     untrust   vrtrust  policy1    40
  2     untrust   trust    policy2    20
  3     untrust   trust    policy3    80

Number of policy: 3
```

Sample Output

show security policies hit-count ascending

```
user@host> show security policies hit-count ascending
index  from zone  to zone  name      policy count
  2     untrust   trust    policy2    20
  1     untrust   vrtrust  policy1    40
  3     untrust   trust    policy3    80

Number of policy: 3
```

Sample Output

show security policies hit-count descending greater-than 70 less-than 100

```
user@host> show security policies hit-count descending greater-than 70 less-than 100
index  from zone  to zone  name      policy count
  2     untrust   trust    policy2    100
  1     untrust   vrtrust  policy1    90
  3     untrust   trust    policy3    80
```

```
Number of policy: 3
```

Sample Output

show security policies hit-count from-zone untrust to-zone trust

```
user@host> show security policies hit-count from-zone untrust to-zone trust
index  from zone  to zone  name      policy count
  2     untrust   trust    policy2    20
  3     untrust   trust    policy3    80

Number of policy: 2
```

Sample Output

show security policies hit-count

```
user@host> show security policies hit-count
Logical system: root-logical-system
Index  From zone      To zone      Name          Policy count  Action
  1     junos-global   junos-global  policy1       5202          Permit
```

Sample Output

show security policies hit-count detail

```
user@host> show security policies hit-count detail
Logical system: root-logical-system
Index  From zone      To zone      Name          Policy count  Action  Redirect
```

1	junos-global	junos-global	policy1	5202	Permit	0
2	junos-global	junos-global	policy2	5202	Reject	3

Sample Output

show security policies hit-count policy-name policy-name detail url-categories

```
user@host> show security policies hit-count policy-name policy1 detail url-categories
Logical system: root-logical-system
Index  From zone      To zone      Name          Policy count  Action  Redirects
1      junos-global   junos-global policy1        5202          Permit   0
URL-Categories
Name          Count
Enhanced_Information_Technology  1000
Enhanced_Collaboration_Office    2000
```

Sample Output

show security policies hit-count policy-name policy-name detail dynamic-applications

```
user@host> show security policies hit-count policy-name policy1 detail dynamic-applications
Logical system: root-logical-system
Index  From zone      To zone      Name          Policy count  Action  Redirect
1      junos-global   junos-global policy1        5202          Permit   0
Dynamic-applications
Name    Application  Count
Junos:SSH      2234
Junos:HTTP     2502
Junos:TWITTER  529
```

Release Information

Command introduced in Junos OS Release 12.1.

The tenant option is introduced in Junos OS Release 18.3R1.

The dynamic-applications and url-categories options are introduced in Junos OS Release 21.2R1.

RELATED DOCUMENTATION

clear security policies hit-count

Security Policies Overview

Unified Policies Configuration Overview

show security resource-manager group active

IN THIS SECTION

- [Syntax | 863](#)
- [Description | 863](#)
- [Options | 863](#)
- [Required Privilege Level | 863](#)
- [Output Fields | 864](#)
- [Sample Output | 864](#)
- [Sample Output | 864](#)
- [Sample Output | 865](#)
- [Sample Output | 865](#)
- [Sample Output | 866](#)
- [Release Information | 866](#)

Syntax

```
show security resource-manager group active
      <group-number >
<node ( <node-id | all | local | primary)>
```

Description

This command displays security information about active groups created through the resource manager.

Options

- none—Display resource manager group service information for all active groups.
- *group-number* —(Optional) Display resource manager group service information for a specific group identification number.
- node—(Optional) For chassis cluster configurations, display active resource manager group service information on a specific node.
 - *node-id* —Identification number of the node. It can be 0 or 1.
 - all—Display information about all nodes.
 - local—Display information about the local node.
 - primary—Display information about the primary node.

Required Privilege Level

view

Output Fields

Table 78 on page 864 lists the output fields for the `show security resource-manager group` command. Output fields are listed in the approximate order in which they appear.

Table 78: show security resource-manager group Output Fields

Field Name	Field Description
Total groups	Total number of groups in the system.
active groups	Number of active groups.
Group ID	Identification number whose group information is displayed.

Sample Output

`show security resource-manager group active`

```
user@host> show security resource-manager group active
Total groups 32, active groups 0
```

Sample Output

`show security resource-manager group active 2048`

```
user@host> show security resource-manager group active 2048
Total groups 2048, active groups 1
Group ID 2048: state - Active
    : Virtual System      - root
    : Application         - SIP ALG
    : Group Timeout       - 65535
    : Number of resources - 3
```



```
Resource ID - 8190  
Resource ID - 8188  
Resource ID - 8187
```

Sample Output

show security resource-manager group active node primary

```
user@host> show security resource-manager group active node primary  
node0:  
-----  
Group ID 1024: Application - SIP ALG  
Total groups 1024, active groups 1
```

Sample Output

show security resource-manager group active node all

```
user@host> show security resource-manager group active node all  
node0:  
-----  
Group ID 1024: Application - SIP ALG  
Total groups 1024, active groups 1  
node1:  
-----  
Group ID 1024: Application - SIP ALG  
Total groups 1024, active groups 1
```

Sample Output

show security resource-manager group active 1024 node all

```
user@host> show security resource-manager group active 1024 node all
node0:
```

```
-----
Group ID 1024: state - Active
  : Application      - SIP ALG
  : Group Timeout   - 65535
  : Number of resources - 3
    Resource ID - 8192
    Resource ID - 8188
    Resource ID - 8187
```

```
node1:
```

```
-----
Group ID 1024: state - Active
  : Application      - SIP ALG
  : Group Timeout   - 65535
  : Number of resources - 3
    Resource ID - 8187
    Resource ID - 8186
    Resource ID - 8190
```

Release Information

Command introduced in Junos OS Release 8.5.

The node options added in Junos OS Release 9.0.

RELATED DOCUMENTATION

[Understanding Traffic Processing on Security Devices](#)

show security resource-manager resource active

IN THIS SECTION

- [Syntax | 867](#)
- [Description | 867](#)
- [Options | 867](#)
- [Required Privilege Level | 868](#)
- [Output Fields | 868](#)
- [Sample Output | 869](#)
- [Sample Output | 869](#)
- [Sample Output | 870](#)
- [Sample Output | 870](#)
- [Release Information | 870](#)

Syntax

```
show security resource-manager resource active
      <resource-id >
<node ( <node-id | all | local | primary)>
```

Description

This command displays security information about active resources created through the resource manager.

Options

- none—Display information for all active resources.

- *resource-id* —(Optional) Display information for a resource with a specific identification number.
- *node*—(Optional) For chassis cluster configurations, display active resource manager information on a specific node.
 - *node-id* —Identification number of the node. It can be 0 or 1.
 - *all*—Display information about all nodes.
 - *local*—Display information about the local node.
 - *primary*—Display information about the primary node.

Required Privilege Level

view

Output Fields

[Table 79 on page 868](#) lists the output fields for the `show security resource-manager resource` command. Output fields are listed in the approximate order in which they appear.

Table 79: show security resource-manager resource Output Fields

Field Name	Field Description
Total resources	Total number of resources in the system.
active resources	Number of active resources.
Resource ID	Identification number whose resource information is displayed.

Sample Output

show security resource-manager resource active

```

user@host> show security resource-manager resource active
Resource ID 7: Group ID - 2, Application - JSF_sip

Resource ID 6: Group ID - 2, Application - JSF_sip

Resource ID 5: Group ID - 2, Application - JSF_sip

Resource ID 4: Group ID - 2, Application - JSF_sip

Resource ID 3: Group ID - 2, Application - JSF_sip

Resource ID 1: Group ID - 2, Application - JSF_sip

Resource ID 2: Group ID - 2, Application - JSF_sip
Total Resources 4326, active resources 7

```

Sample Output

show security resource-manager resource active 5

```

user@host> show security resource-manager resource active 5
Resource ID 5: state - Active
  Application      - asl_client
  Parent group     - 2
  Policy           - 5
  From zone        - untrust
  To zone          - trust
  Resource timeout - 0
  Number of sessions - 0
  Number of Holes  - 1
    Source IP range - {0.0.0.0, 0.0.0.0}
    Source port range - {0, 0}
    Destination IP range - {33.1.0.200, 33.1.0.200}
    Destination port range - {5060, 5060}

```

```
Translated          - {0.0.0.0/0 -> 33.1.0.200/5060}
Protocol           - 17
Reference count     - 1
```

Sample Output

show security resource-manager resource active node local

```
user@host> show security resource-manager resource active node local
node0:
-----
Resource ID 8192: Group ID - 1024, Application - SIP ALG
Resource ID 8188: Group ID - 1024, Application - SIP ALG
Resource ID 8187: Group ID - 1024, Application - SIP ALG
Total Resources 8192, active resources 3
```

Sample Output

show security resource-manager resource active node primary

```
user@host> show security resource-manager resource active node primary
node0:
-----
Resource ID 8192: Group ID - 1024, Application - SIP ALG
Resource ID 8188: Group ID - 1024, Application - SIP ALG
Resource ID 8187: Group ID - 1024, Application - SIP ALG
Total Resources 8192, active resources 3
```

Release Information

Command introduced in Junos OS Release 8.5.

The node options added in Junos OS Release 9.0.

RELATED DOCUMENTATION

[Understanding Traffic Processing on Security Devices | 2](#)

show security resource-manager settings

IN THIS SECTION

- [Syntax | 871](#)
- [Description | 871](#)
- [Options | 872](#)
- [Required Privilege Level | 872](#)
- [Output Fields | 872](#)
- [Sample Output | 873](#)
- [Sample Output | 873](#)
- [Sample Output | 873](#)
- [Release Information | 874](#)

Syntax

```
show security resource-manager settings  
<node ( node-id | all | local | primary)>
```

Description

Display resource manager settings.

Options

`node`—(Optional) For chassis cluster configurations, display resource manager settings on a specific node.

- `node-id`—Identification number of the node. It can be 0 or 1.
- `all`—Display information about all nodes.
- `local`—Display information about the local node.
- `primary`—Display information about the primary node.

Required Privilege Level

view

Output Fields

[Table 80 on page 872](#) lists the output fields for the `show security resource-manager settings` command. Output fields are listed in the approximate order in which they appear.

Table 80: show security resource-manager settings Output Fields

Field Name	Field Description
Client Heartbeat	Time after which idle an resource manager client is timed out.
Count	Number of active clients.
Pinhole age	Duration for which the temporary opening in the security firewall (pinhole) is open for specified traffic. If the specified traffic does not exist during this time period, the pinhole is timed out.

Sample Output

show security resource-manager settings

```
user@host> show security resource-manager settings
Client Heartbeat: timeout 600 seconds, count 5
Pinhole age: 32 seconds
```

Sample Output

show security resource-manager settings node primary

```
user@host> show security resource-manager settings node primary
node0:
-----
Client heartbeat: timeout 600 seconds, count 5
Pinhole age: 120 seconds
```

Sample Output

show security resource-manager settings node all

```
user@host> show security resource-manager settings node all
node0:
-----
Client heartbeat: timeout 600 seconds, count 5
Pinhole age: 120 seconds
node1:
-----
Client heartbeat: timeout 600 seconds, count 5
Pinhole age: 120 seconds
```

Release Information

Command introduced in Junos OS Release 8.5; node options added in Junos OS Release 9.0.

RELATED DOCUMENTATION

[Understanding Traffic Processing on Security Devices | 2](#)

show security resource-manager summary

IN THIS SECTION

- [Syntax | 874](#)
- [Description | 874](#)
- [Required Privilege Level | 875](#)
- [Output Fields | 875](#)
- [Sample Output | 875](#)
- [Release Information | 876](#)

Syntax

```
show security resource-manager summary
```

Description

This command displays summary information about active resources, clients, groups, and sessions created through the resource manager.

Required Privilege Level

view

Output Fields

[Table 81 on page 875](#) lists the output fields for the `show security resource-manager summary` command. Output fields are listed in the approximate order in which they appear.

Table 81: show security resource-manager summary Output Fields

Field Name	Field Description
Active resource-manager clients	Number of active resource manager clients.
Active resource-manager groups	Number of active resource manager groups.
Active resource-manager resources	Number of active resource manager resources.
Active resource-manager sessions	Number of active resource manager sessions.

Sample Output

show security resource-manager summary

```
user@host> show security resource-manager summary
```

```
Active resource-manager clients : 15
Active resource-manager groups  : 1
Active resource-manager resources : 1
Active resource-manager sessions : 0
```

Release Information

Command introduced in Junos OS Release 11.4.

RELATED DOCUMENTATION

[Understanding Traffic Processing on Security Devices](#) | 2

show security screen ids-option

IN THIS SECTION

- [Syntax](#) | 876
- [Description](#) | 877
- [Options](#) | 877
- [Required Privilege Level](#) | 877
- [Output Fields](#) | 877
- [Sample Output](#) | 881
- [Sample Output](#) | 881
- [Sample Output](#) | 882
- [Release Information](#) | 884

Syntax

```
show security screen ids-option  
  screen-name  
  logical-system  
  root-logical-system  
  tenant
```

Description

Display the configuration information about the specified security screen. You can configure a `ids-option` to enable screen protection on the SRX Series Firewalls.

Options

- `screen-name` —Name of the screen.
- `logical-system`—Name of the logical system.
- `root-logical-system`—Displays root logical system as default.
- `tenant`—Name of the tenant system.

Required Privilege Level

view

Output Fields

[Table 82 on page 877](#) lists the output fields for the `show security screen ids-option` command. Output fields are listed in the approximate order in which they appear.

Table 82: show security screen ids-option Output Fields

Field Name	Field Description
TCP address sweep threshold	Number of microseconds for which the device accepts 10 TCP packets from the same remote source to different destination addresses.
TCP port scan threshold	Number of microseconds during which the device accepts packets from the same remote source with up to 10 different port numbers.

Table 82: show security screen ids-option Output Fields (Continued)

Field Name	Field Description
ICMP address sweep threshold	Number of microseconds during which up to 10 ICMP echo requests from the same host are allowed into the device.
UDP flood threshold	Number of UDP packets per second allowed to ping the same destination address before the device rejects further UDP packets.
UDP port scan threshold	Number of microseconds during which the device accepts packets from the same remote source IP with up to 10 different destination port numbers.
TCP winnuke	Enable or disable the detection of TCP WinNuke attacks.
TCP SYN flood attack threshold	Number of SYN packets per second required to trigger the SYN proxy response.
TCP SYN flood alarm threshold	Number of half-complete proxy connections per second at which the device makes entries in the event alarm log.
TCP SYN flood source threshold	Number of SYN segments to be received per second before the device begins dropping connection requests.
TCP SYN flood destination threshold	Number of SYN segments received per second before the device begins dropping connection requests.
TCP SYN flood timeout	Maximum length of time before a half-completed connection is dropped from the queue.
TCP SYN flood queue size	Number of proxy connection requests that can be held in the proxy connection queue before the device begins rejecting new connection requests.
ICMP large packet	Enable or disable the detection of any ICMP frame with an IP length greater than 1024 bytes.

Table 82: show security screen ids-option Output Fields (Continued)

Field Name	Field Description
UDP address sweep threshold	Number of microseconds for which the device accepts 10 UDP packets from the same remote source to different destination addresses.
IPv6 extension routing	Enable or disable the IPv6 extension routing screen option.
IPv6 extension shim6	Enable or disable the IPv6 extension shim6 screen option.
IPv6 extension fragment/IP block fragment	Enable or disable the IPv6 extension fragment screen option.
IPv6 extension AH	Enable or disable the IPv6 extension Authentication Header Protocol screen option.
IPv6 extension ESP	Enable or disable the IPv6 extension Encapsulating Security Payload screen option.
IPv6 extension mobility	Enable or disable the IPv6 extension mobility screen option.
IPv6 extension HIP	Enable or disable the IPv6 extension Host Identify Protocol screen option.
IPv6 extension no next	Enable or disable the IPv6 extension no-next screen option.
IPv6 extension user-defined	Enable or disable the IPv6 extension user-defined screen option.
IPv6 extension HbyH jumbo	Enable or disable the IPv6 extension HbyH jumbo screen option.
IPv6 extension HbyH RPL	Enable or disable the IPv6 extension HbyH RPL screen option.
IPv6 extension HbyH router alert	Enable or disable the IPv6 extension HbyH router screen option.

Table 82: show security screen ids-option Output Fields (Continued)

Field Name	Field Description
IPv6 extension HbyH quick start	Enable or disable the IPv6 extension HbyH quick-start screen option.
IPv6 extension HbyH CALIPSO	Enable or disable the IPv6 extension HbyH Common Architecture Label IPv6 Security Screen option.
IPv6 extension HbyH SMF DPD	Enable or disable the IPv6 extension HbyH Simplified Multicast Forwarding IPv6 Duplicate Packet Detection screen option.
IPv6 extension HbyH user-defined	Enable or disable the IPv6 extension HbyH user-defined screen option.
IPv6 extension Dst tunnel encaps limit	Enable or disable the IPv6 extension distributed (network) storage tunnel encapsulation limit screen option.
IPv6 extension Dst home address	Enable or disable the IPv6 extension DST home address screen option.
IPv6 extension Dst ILNP nonce	Enable or disable the IPv6 extension DST Identifier-Locator Network Protocol nonce screen option.
IPv6 extension Dst line-id	Enable or disable the IPv6 extension DST line-ID screen option.
IPv6 extension Dst user-defined	Enable or disable the IPv6 extension DST user-defined screen option.
IPv6 extension header limit	Threshold for the number of IPv6 extension headers that can pass through the screen.
IPv6 malformed header	Enable or disable the IPv6 malformed header screen option.
ICMPv6 malformed header	Enable or disable the ICMPv6 malformed packet screen option.
UDP flood white-list	Allowlist of IP addresses to bypass UDP flood detection.

Table 82: show security screen ids-option Output Fields (Continued)

Field Name	Field Description
IP block fragment white-list	Allowlist of IP addresses to bypass IP block fragmentation check.
Session source limit threshold	Limit the number of concurrent sessions the device can initiate from a single source IP address or the number of sessions it can direct to a single destination IP address.
Logical system/Tenant	Name of the logical system or tenant system.

Sample Output

show security screen ids-option jscreen

```

user@host> show security screen ids-option jscreen
Screen object status:
Name                               Value
TCP port scan threshold            5000
UDP port scan threshold            10000
ICMP address sweep threshold        5000

```

Sample Output

show security screen ids-option jscreen (IPv6)

```

user@host> show security screen ids-option jscreen

Screen object status:

Name                               Value
ICMP ping of death                 enabled
.....

```

IPv6 extension routing	enabled
IPv6 extension shim6	enabled
IPv6 extension fragment	enabled
IPv6 extension AH	enabled
IPv6 extension ESP	enabled
IPv6 extension mobility	enabled
IPv6 extension HIP	enabled
IPv6 extension no next	enabled
IPv6 extension user-defined	enabled
IPv6 extension HbyH jumbo	enabled
IPv6 extension HbyH RPL	enabled
IPv6 extension HbyH router alert	enabled
IPv6 extension HbyH quick start	enabled
IPv6 extension HbyH CALIPSO	enabled
IPv6 extension HbyH SMF DPD	enabled
IPv6 extension HbyH user-defined	enabled
IPv6 extension Dst tunnel encap limit	enabled
IPv6 extension Dst home address	enabled
IPv6 extension Dst ILNP nonce	enabled
IPv6 extension Dst line-id	enabled
IPv6 extension Dst user-defined	enabled
IPv6 extension header limit	20
IPv6 Malformed header	enabled
ICMPv6 malformed packet	enabled

Sample Output

show security screen ids-option jscreen1 node all

```
user@host> show security screen ids-option jscreen1 node all
```

```
node0:
```

```
-----
```

```
Screen object status:
```

Name	Value
UDP flood threshold	1000
TCP winnuke	enabled
TCP SYN flood attack threshold	200

```

TCP SYN flood alarm threshold      512
TCP SYN flood source threshold     4000
TCP SYN flood destination threshold 4000
TCP SYN flood timeout              20
TCP SYN flood queue size           1024
ICMP large packet                  enabled
node1:
-----
Screen object status:
Name                               Value
UDP flood threshold                1000
TCP winnuke                        enabled
TCP SYN flood attack threshold     200
TCP SYN flood alarm threshold      512
TCP SYN flood source threshold     4000
TCP SYN flood destination threshold 4000
TCP SYN flood timeout              20
TCP SYN flood queue size           1024
ICMP large packet                  enabled

```

show security screen ids-option jscreen tenant TN1

```

user@host> show security screen ids-option jscreen tenant TN1

Screen object status:

Name                               value
UDP flood threshold                1000
UDP flood white-list               a1
UDP flood white-list               a2

```

show security screen ids-option jscreen tenant all

```

user@host> show security screen ids-option jscreen tenant all

Logical system: root-logical-system
Screen object status:

Name                               value

```

```

UDP flood threshold          1
UDP flood white-list        a1
UDP flood white-list        a2
IP block fragment           enabled
Session source limit threshold 5

```

Tenant: TN1

Screen object status:

Name	value
UDP flood threshold	1000
UDP flood white-list	a1
UDP flood white-list	a2

show security screen ids-option jscreen (IP block fragment screen)

```

user@host> show security screen ids-option jscreen

```

Screen object status:

Name	value
IP block fragment	enabled
IP block fragment white-list	a1
IP block fragment white-list	a2

Release Information

Command introduced in Junos OS Release 8.5. Support for UDP port scan added in Junos OS Release 12.1X47-D10.

Support for node option added in Junos OS Release 9.0.

Support for IPv6 extension header screens added in Junos OS Release 12.1X46-D10.

The tenant option is introduced in Junos OS Release 18.3R1.

The IP block fragment allowlist option added in Junos OS Release 22.2R1.

RELATED DOCUMENTATION

ids-option

Example: Configuring Multiple Screening Options

show security screen statistics

IN THIS SECTION

- [Syntax | 885](#)
- [Description | 886](#)
- [Options | 886](#)
- [Required Privilege Level | 886](#)
- [Output Fields | 886](#)
- [Sample Output | 890](#)
- [Sample Output | 891](#)
- [Sample Output | 892](#)
- [Sample Output | 893](#)
- [Sample Output | 893](#)
- [Sample Output | 894](#)
- [Release Information | 900](#)

Syntax

```
show security screen statistics <zone zone-name / interface interface-name>  
logical-system <logical-system-name | all>  
root-logical-system  
tenant <tenant-name >
```

Description

Display intrusion detection service (IDS) security screen statistics.

Options

- `zone zone-name`—Display screen statistics for this security zone.
- `interface interface-name`—Display screen statistics for this interface.
- `logical-system-name`—Display screen statistics for the named logical system.
- `root-logical-system`—(Optional) Display screen statistics for the primary logical system only.
- `tenant`—Display the name of the tenant system.

Required Privilege Level

view

Output Fields

[Table 83 on page 886](#) lists the output fields for the `show security screen statistics` command. Output fields are listed in the approximate order in which they appear.

Table 83: show security screen statistics Output Fields

Field Name	Field Description
ICMP flood	Internet Control Message Protocol (ICMP) flood counter. An ICMP flood typically occurs when ICMP echo requests use all resources in responding, such that valid network traffic can no longer be processed.

Table 83: show security screen statistics Output Fields (Continued)

Field Name	Field Description
UDP flood	User Datagram Protocol (UDP) flood counter. UDP flooding occurs when an attacker sends IP packets containing UDP datagrams with the purpose of slowing down the resources, such that valid connections can no longer be handled.
TCP winnuke	Number of Transport Control Protocol (TCP) WinNuke attacks. WinNuke is a denial-of-service (DoS) attack targeting any computer on the Internet running Windows.
TCP port scan	Number of TCP port scans. The purpose of this attack is to scan the available services in the hopes that at least one port will respond, thus identifying a service to target.
ICMP address sweep	Number of ICMP address sweeps. An IP address sweep can occur with the intent of triggering responses from active hosts.
IP tear drop	Number of teardrop attacks. Teardrop attacks exploit the reassembly of fragmented IP packets.
TCP SYN flood	Number of TCP SYN attacks.
IP spoofing	Number of IP spoofs. IP spoofing occurs when an invalid source address is inserted in the packet header to make the packet appear to come from a trusted source.
ICMP ping of death	ICMP ping of death counter. Ping of death occurs when IP packets are sent that exceed the maximum legal length (65,535 bytes).
IP source route option	Number of IP source route attacks.
TCP address sweep	Number of TCP address sweeps.

Table 83: show security screen statistics Output Fields (Continued)

Field Name	Field Description
TCP land attack	Number of land attacks. Land attacks occur when an attacker sends spoofed SYN packets containing the IP address of the victim as both the destination and source IP address.
TCP SYN fragment	Number of TCP SYN fragments.
TCP no flag	Number of TCP headers without flags set. A normal TCP segment header has at least one control flag set.
IP unknown protocol	Number of IPs.
IP bad options	Number of invalid options.
IP record route option	Number of packets with the IP record route option enabled. This option records the IP addresses of the network devices along the path that the IP packet travels.
IP timestamp option	Number of IP timestamp option attacks. This option records the time (in Universal Time) when each network device receives the packet during its trip from the point of origin to its destination.
IP security option	Number of IP security option attacks.
IP loose source route option	Number of IP loose source route option attacks. This option specifies a partial route list for a packet to take on its journey from source to destination.
IP strict source route option	Number of IP strict source route option attacks. This option specifies the complete route list for a packet to take on its journey from source to destination.
IP stream option	Number of stream option attacks. This option provides a way for the 16-bit SATNET stream identifier to be carried through networks that do not support streams.

Table 83: show security screen statistics Output Fields (Continued)

Field Name	Field Description
ICMP fragment	Number of ICMP fragments. Because ICMP packets contain very short messages, there is no legitimate reason for ICMP packets to be fragmented. If an ICMP packet is so large that it must be fragmented, something is amiss.
ICMP large packet	Number of large ICMP packets.
TCP SYN FIN	Number of TCP SYN FIN packets.
TCP FIN no ACK	Number of TCP FIN flags without the acknowledge (ACK) flag.
Source session limit	Number of concurrent sessions that can be initiated from a source IP address.
TCP SYN-ACK-ACK proxy	Number of TCP flags enabled with SYN-ACK-ACK. To prevent flooding with SYN-ACK-ACK sessions, you can enable the SYN-ACK-ACK proxy protection screen option. After the number of connections from the same IP address reaches the SYN-ACK-ACK proxy threshold and SRX Series Firewalls running Junos OS reject further connection requests from that IP address.
IP block fragment	Number of IP block fragments.
Destination session limit	Number of concurrent sessions that can be directed to a single destination IP address.
UDP address sweep	Number of UDP address sweeps.

Table 83: show security screen statistics Output Fields (Continued)

IPv6 extension header	Number of packets filtered for the defined IPv6 extension headers.
IPv6 extension hop by hop option	Number of packets filtered for the defined IPv6 hop-by-hop option types.

IPv6 extension destination option	Number of packets filtered for the defined IPv6 destination option types.
IPv6 extension header limit	Number of packets filtered for crossing the defined IPv6 extension header limit.
IPv6 malformed header	Number of IPv6 malformed headers defined for the intrusion detection service (IDS).
ICMPv6 malformed packet	Number of ICMPv6 malformed packets defined for the IDS options.

Sample Output

show security screen statistics zone scrzone

```

user@host> show security screen statistics zone scrzone
Screen statistics:
IDS attack type           Statistics
ICMP flood                0
UDP flood                 0
TCP winnuke               0
TCP port scan             91
ICMP address sweep        0
TCP sweep                 0
UDP sweep                  0
IP tear drop              0
TCP SYN flood             0
IP spoofing                0
ICMP ping of death        0
IP source route option    0
TCP land attack           0
TCP SYN fragment          0
TCP no flag                0
IP unknown protocol       0
IP bad options             0
IP record route option    0
IP timestamp option       0

```

IP security option	0
IP loose source route option	0
IP strict source route option	0
IP stream option	0
ICMP fragment	0
ICMP large packet	0
TCP SYN FIN	0
TCP FIN no ACK	0
Source session limit	0
TCP SYN-ACK-ACK proxy	0
IP block fragment	0
Destination session limit	0

Sample Output

show security screen statistics zone untrust (IPv6)

```
user@host>show security screen statistics zone untrust
```

```
Screen statistics:
```

IDS attack type	Statistics
ICMP flood	0
UDP flood	0
TCP winnuke	0
.....	
IPv6 extension header	0
IPv6 extension hop by hop option	0
IPv6 extension destination option	0
IPv6 extension header limit	0
IPv6 malformed header	0
ICMPv6 malformed packet	0

Sample Output

show security screen statistics interface ge-0/0/3

```
user@host> show security screen statistics interface ge-0/0/3
```

```
Screen statistics:
```

IDS attack type	Statistics
ICMP flood	0
UDP flood	0
TCP winnuke	0
TCP port scan	91
ICMP address sweep	0
TCP sweep	0
UDP sweep	0
IP tear drop	0
TCP SYN flood	0
IP spoofing	0
ICMP ping of death	0
IP source route option	0
TCP land attack	0
TCP SYN fragment	0
TCP no flag	0
IP unknown protocol	0
IP bad options	0
IP record route option	0
IP timestamp option	0
IP security option	0
IP loose source route option	0
IP strict source route option	0
IP stream option	0
ICMP fragment	0
ICMP large packet	0
TCP SYN FIN	0
TCP FIN no ACK	0
Source session limit	0
TCP SYN-ACK-ACK proxy	0
IP block fragment	0
Destination session limit	0

Sample Output

show security screen statistics interface ge-0/0/1 (IPv6)

```
user@host> show security screen statistics interface ge-0/0/1
```

```
Screen statistics:
```

IDS attack type	Statistics
ICMP flood	0
UDP flood	0
.....	
IPv6 extension header	0
IPv6 extension hop by hop option	0
IPv6 extension destination option	0
IPv6 extension header limit	0
IPv6 malformed header	0
ICMPv6 malformed packet	0

Sample Output

show security screen statistics interface ge-0/0/1 node primary

```
user@host> show security screen statistics interface ge-0/0/1 node primary
```

```
node0:
```

```
-----  
Screen statistics:
```

IDS attack type	Statistics
ICMP flood	1
UDP flood	1
TCP winnuke	1
TCP port scan	1
ICMP address sweep	1
TCP sweep	1
UDP sweep	1
IP tear drop	1
TCP SYN flood	1
IP spoofing	1

ICMP ping of death	1
IP source route option	1
TCP land attack	1
TCP SYN fragment	1
TCP no flag	1
IP unknown protocol	1
IP bad options	1
IP record route option	1
IP timestamp option	1
IP security option	1
IP loose source route option	1
IP strict source route option	1
IP stream option	1
ICMP fragment	1
ICMP large packet	1
TCP SYN FIN	1
TCP FIN no ACK	1
Source session limit	1
TCP SYN-ACK-ACK proxy	1
IP block fragment	1
Destination session limit	1

Sample Output

show security screen statistics zone trust logical-system all

```
user@host> show security screen statistics zone trust logical-system all
```

```
Logical system: root-logical-system
```

```
Screen statistics:
```

IDS attack type	Statistics
ICMP flood	0
UDP flood	0
TCP winnuke	0
TCP port scan	0
ICMP address sweep	0
TCP sweep	0
UDP sweep	0
IP tear drop	0

TCP SYN flood	0
IP spoofing	0
ICMP ping of death	0
IP source route option	0
TCP land attack	0
TCP SYN fragment	0
TCP no flag	0
IP unknown protocol	0
IP bad options	0
IP record route option	0
IP timestamp option	0
IP security option	0
IP loose source route option	0
IP strict source route option	0
IP stream option	0
ICMP fragment	0
ICMP large packet	0
TCP SYN FIN	0
TCP FIN no ACK	0
Source session limit	0
TCP SYN-ACK-ACK proxy	0
IP block fragment	0
Destination session limit	0

Logical system: ls1

Screen statistics:

IDS attack type	Statistics
ICMP flood	0
UDP flood	0
TCP winnuke	0
TCP port scan	0
ICMP address sweep	0
TCP sweep	0
UDP sweep	0
IP tear drop	0
TCP SYN flood	0
IP spoofing	0
ICMP ping of death	0
IP source route option	0
TCP land attack	0
TCP SYN fragment	0
TCP no flag	0

IP unknown protocol	0
IP bad options	0
IP record route option	0
IP timestamp option	0
IP security option	0
IP loose source route option	0
IP strict source route option	0
IP stream option	0
ICMP fragment	0
ICMP large packet	0
TCP SYN FIN	0
TCP FIN no ACK	0
Source session limit	0
TCP SYN-ACK-ACK proxy	0
IP block fragment	0
Destination session limit	0

Logical system: ls2

Screen statistics:

IDS attack type	Statistics
ICMP flood	0
UDP flood	0
TCP winnuke	0
TCP port scan	0
ICMP address sweep	0
TCP sweep	0
UDP sweep	0
IP tear drop	0
TCP SYN flood	0
IP spoofing	0
ICMP ping of death	0
IP source route option	0
TCP land attack	0
TCP SYN fragment	0
TCP no flag	0
IP unknown protocol	0
IP bad options	0
IP record route option	0
IP timestamp option	0
IP security option	0
IP loose source route option	0
IP strict source route option	0

IP stream option	0
ICMP fragment	0
ICMP large packet	0
TCP SYN FIN	0
TCP FIN no ACK	0
Source session limit	0
TCP SYN-ACK-ACK proxy	0
IP block fragment	0
Destination session limit	0

show security screen statistics zone trust tenant TN1

```
user@host> show security screen statistics zone trust tenant TN1
```

Screen statistics:

IDS attack type	Statistics
ICMP flood	0
UDP flood	0
TCP winnuke	0
TCP port scan	0
UDP port scan	0
ICMP address sweep	0
TCP sweep	0
UDP sweep	0
IP tear drop	0
TCP SYN flood	0
SYN flood source	0
SYN flood destination	0
IP spoofing	0
ICMP ping of death	0
IP source route option	0
TCP land attack	0
TCP SYN fragment	0
TCP no flag	0
IP unknown protocol	0
IP bad options	0
IP record route option	0
IP timestamp option	0
IP security option	0
IP loose source route option	0

IP strict source route option	0
IP stream option	0
ICMP fragment	0
ICMP large packet	0
TCP SYN FIN	0
TCP FIN no ACK	0
Source session limit	0
TCP SYN-ACK-ACK proxy	0
IP block fragment	0
Destination session limit	0
IPv6 extension header	0
IPv6 extension hop by hop option	0
IPv6 extension destination option	0
IPv6 extension header limit	0
IPv6 malformed header	0
ICMPv6 malformed packet	0
IP tunnel summary	0

show security screen statistics zone trust tenant all

```
user@host> show security screen statistics zone trust tenant all
```

```
Logical system: root-logical-system
screen statistics:
```

IDS attack type	Statistics
ICMP flood	0
UDP flood	0
TCP winnuke	0
TCP port scan	0
UDP port scan	0
ICMP address sweep	0
TCP sweep	0
UDP sweep	0
IP tear drop	0
TCP SYN flood	0
SYN flood source	0
SYN flood destination	0
IP spoofing	0
ICMP ping of death	0
IP source route option	0

TCP land attack	0
TCP SYN fragment	0
TCP no flag	0
IP unknown protocol	0
IP bad options	0
IP record route option	0
IP timestamp option	0
IP security option	0
IP loose source route option	0
IP strict source route option	0
IP stream option	0
ICMP fragment	0
ICMP large packet	0
TCP SYN FIN	0
TCP FIN no ACK	0
Source session limit	0
TCP SYN-ACK-ACK proxy	0
IP block fragment	0
Destination session limit	0
IPv6 extension header	0
IPv6 extension hop by hop option	0
IPv6 extension destination option	0
IPv6 extension header limit	0
IPv6 malformed header	0
ICMPv6 malformed packet	0
IP tunnel summary	0

Tenant: TN1

Screen statistics:

IDS attack type	Statistics
ICMP flood	0
UDP flood	0
TCP winnuke	0
TCP port scan	0
UDP port scan	0
ICMP address sweep	0
TCP sweep	0
UDP sweep	0
IP tear drop	0
TCP SYN flood	0
SYN flood source	0
SYN flood destination	0

IP spoofing	0
ICMP ping of death	0
IP source route option	0
TCP land attack	0
TCP SYN fragment	0
TCP no flag	0
IP unknown protocol	0
IP bad options	0
IP record route option	0
IP timestamp option	0
IP security option	0
IP loose source route option	0
IP strict source route option	0
IP stream option	0
ICMP fragment	0
ICMP large packet	0
TCP SYN FIN	0
TCP FIN no ACK	0
Source session limit	0
TCP SYN-ACK-ACK proxy	0
IP block fragment	0
Destination session limit	0
IPv6 extension header	0
IPv6 extension hop by hop option	0
IPv6 extension destination option	0
IPv6 extension header limit	0
IPv6 malformed header	0
ICMPv6 malformed packet	0
IP tunnel summary	0

Release Information

Command introduced in Junos OS Release 8.5.

The `node` option added in Junos OS Release 9.0.

The `logical-system all` option added in Junos OS Release 11.2R6.

Support for IPv6 extension header screens added in Junos OS Release 12.1X46-D10.

The tenant option is introduced in Junos OS Release 18.3R1.

RELATED DOCUMENTATION

clear security screen statistics

clear security screen statistics interface

clear security screen statistics zone

Example: Configuring Multiple Screening Options

show security softwires

IN THIS SECTION

- [Syntax | 901](#)
- [Description | 901](#)
- [Options | 902](#)
- [Required Privilege Level | 902](#)
- [Sample Output | 902](#)
- [Release Information | 903](#)

Syntax

```
show security softwires <software-name software-name>  
<logical-system (all | logical-system-name)>
```

Description

Display a summary of information of all the softwire concentrators and details on concentrators with specified name.

Options

- software-name** *software-name* Display the details of the specified software concentrator.
- logical-system** (all | *logical-system-name*) Display software information for all logical systems or for a specified logical system. This option is only available to the primary administrator.

Required Privilege Level

view

Sample Output

command-name

```
user@host> show security softwares
Software Name      SC Address      Status  Number of SI connected
SC-CSSI-1         3001::1        Connected  2
SC-CSSI-str00     3100::1        Active    0
SC-CSSI-str01     3101::1        Inactive  0
SC-CSSI-str02     3001::1        Connected 2520
```

command-name

```
user@host> show security softwares software-name SC-CSSI-1
Name of software: SC-CSSI-1
  SC status: Connected
  SC address: 3001::1
  Zone: trust
  VR ID: 0
  SI Address      SI Status      SPU
  3001::2        Active         spu-1
  3001::2        Active         spu-21
  SI number: 2
```

command-name

```
user@host> show security softwires logical-system ls-product-design
Software Name      SC Address      Status  Number of SI connected
sc_1               3000::1        Connected  1
```

Release Information

Command introduced in Junos OS Release 10.4. The `logical-system` option introduced in Junos OS Release 12.1.

RELATED DOCUMENTATION

[Understanding Traffic Processing on Security Devices | 2](#)

show security zones

IN THIS SECTION

- [Syntax | 904](#)
- [Description | 904](#)
- [Options | 904](#)
- [Required Privilege Level | 905](#)
- [Output Fields | 905](#)
- [Sample Output | 906](#)
- [Release Information | 912](#)

Syntax

```
show security zones
<zone-name>
<all-logical-systems-tenants>
<detail>
<logical-system (logical-system-name | all)>
<root-logical-system>
<tenant (tenant-name | all)>
<terse>
<type (functional | security)>
```

Description

This command displays the information about the security zones. You can define a security zone, which allows you to divide the network into different segments and apply different security options to each segment.

Options

- *none*—Displays information about all the security zones configured.
- *zone-name*—(Optional) Displays information about the specified security zone.
- *all-logical-systems-tenants*—(Optional) Displays the information about the security zone of all logical systems and tenant systems.
- *detail*—(Optional) Displays the detail level information about the security zone.
- *logical-system logical-system-name*—(Optional) Displays the information about the security zones of a specified logical system.
- *logical-system all*—(Optional) Displays the information about the security zones of all logical systems.
- *root-logical-system*—(Optional) Displays the information about the security zones of the root logical system.
- *tenant tenant-name*—(Optional) Displays the information about the security zones of a specified tenant system.

- `tenant all`—(Optional) Displays the information about the security zones of all tenant systems.
- `terse`—(Optional) Displays the specified level information about the security zone.
- `type functional`—(Optional) Displays the information for functional zones.
- `type security`—(Optional) Displays the information for security zones.

Required Privilege Level

view

Output Fields

[Table 84 on page 905](#) lists the output fields for the `show security zones` command. Output fields are listed in the approximate order in which they appear.

Table 84: show security zones Output Fields

Field Name	Field Description	Level of Output
Functional zone	Name of the functional zone.	none
Security zone	Name of the security zone.	detail none
Description	Description of the security zone.	detail none
Policy configurable	Whether the policy can be configured or not.	detail none
Interfaces bound	Number of interfaces in the zone.	detail none

Table 84: show security zones Output Fields (Continued)

Field Name	Field Description	Level of Output
Interfaces	List of the interfaces in the zone.	detail none
Zone	Name of the zone.	terse
Type	Type of the zone.	terse
Logical system	Name of the logical system.	detail
Tenant	Name of the tenant system.	detail

Sample Output

show security zones

```

user@host> show security zones
Functional zone: management
  Description: This is the management zone.
  Policy configurable: No
  Interfaces bound: 1
  Interfaces:
    ge-0/0/0.0
Security zone: Host
  Description: This is the host zone.
  Send reset for non-SYN session TCP packets: Off
  Policy configurable: Yes
  Interfaces bound: 1
  Interfaces:
    fxp0.0
Security zone: abc
  Description: This is the abc zone.
  Send reset for non-SYN session TCP packets: Off

```

```

Policy configurable: Yes
Interfaces bound: 1
Interfaces:
  ge-0/0/1.0
Security zone: def
Description: This is the def zone.
Send reset for non-SYN session TCP packets: Off
Policy configurable: Yes
Interfaces bound: 1
Interfaces:
  ge-0/0/2.0

```

show security zones abc

```

user@host> show security zones abc
Security zone: abc
Description: This is the abc zone.
Send reset for non-SYN session TCP packets: Off
Policy configurable: Yes
Interfaces bound: 1
Interfaces:
  ge-0/0/1.0

```

show security zones all-logical-systems-tenants

```

user@host> show security zones all-logical-systems-tenants

Logical system: root-logical-system

Security zone: HOST
Send reset for non-SYN session TCP packets: Off
Policy configurable: Yes
Interfaces bound: all
Interfaces:

Security zone: junos-host
Send reset for non-SYN session TCP packets: Off
Policy configurable: Yes
Interfaces bound: 0
Interfaces:

```

```
Logical system: LSYS1
```

```
Security zone: z1
```

```
  Send reset for non-SYN session TCP packets: Off
```

```
  Policy configurable: Yes
```

```
  Interfaces bound: 0
```

```
  Interfaces:
```

```
Logical system: TSYS1
```

```
Security zone: z3a
```

```
  Send reset for non-SYN session TCP packets: Off
```

```
  Policy configurable: Yes
```

```
  Interfaces bound: 0
```

```
  Interfaces:
```

```
Security zone: z3b
```

```
  Send reset for non-SYN session TCP packets: Off
```

```
  Policy configurable: Yes
```

```
  Interfaces bound: 0
```

```
  Interfaces:
```

```
Security zone: z3c
```

```
  Send reset for non-SYN session TCP packets: Off
```

```
  Policy configurable: Yes
```

```
  Interfaces bound: 0
```

```
  Interfaces:
```

show security zones abc detail

```
user@host> show security zones abc detail
```

```
Security zone: abc
```

```
  Description: This is the abc zone.
```

```
  Send reset for non-SYN session TCP packets: Off
```

```
  Policy configurable: Yes
```

```
  Interfaces bound: 1
```

```
  Interfaces:
```

```
    ge-0/0/1.0
```

show security zones logical-system LSYS1

```
user@host> show security zones logical-system LSYS1
```

```
Security zone: z1  
  Send reset for non-SYN session TCP packets: Off  
  Policy configurable: Yes  
  Interfaces bound: 0  
  Interfaces:
```

show security zones logical-system all

```
user@host> show security zones logical-system all
```

```
Logical system: root-logical-system
```

```
Security zone: HOST  
  Send reset for non-SYN session TCP packets: Off  
  Policy configurable: Yes  
  Interfaces bound: all  
  Interfaces:
```

```
Security zone: junos-host  
  Send reset for non-SYN session TCP packets: Off  
  Policy configurable: Yes  
  Interfaces bound: 0  
  Interfaces:
```

```
Logical system: LSYS1
```

```
Security zone: z1  
  Send reset for non-SYN session TCP packets: Off  
  Policy configurable: Yes  
  Interfaces bound: 0  
  Interfaces:
```

show security zones root-logical-system

```
user@host> show security zones root-logical-system
```

```
Security zone: HOST
```

```
Send reset for non-SYN session TCP packets: Off
```

```
Policy configurable: Yes
```

```
Interfaces bound: all
```

```
Interfaces:
```

```
Security zone: junos-host
```

```
Send reset for non-SYN session TCP packets: Off
```

```
Policy configurable: Yes
```

```
Interfaces bound: 0
```

```
Interfaces:
```

show security zones tenant TSYS1

```
user@host> show security zones tenant TSYS1
```

```
Security zone: z3a
```

```
Send reset for non-SYN session TCP packets: Off
```

```
Policy configurable: Yes
```

```
Interfaces bound: 0
```

```
Interfaces:
```

```
Security zone: z3b
```

```
Send reset for non-SYN session TCP packets: Off
```

```
Policy configurable: Yes
```

```
Interfaces bound: 0
```

```
Interfaces:
```

```
Security zone: z3c
```

```
Send reset for non-SYN session TCP packets: Off
```

```
Policy configurable: Yes
```

```
Interfaces bound: 0
```

```
Interfaces:
```

show security zone tenant all

```
user@host> show security zone tenant all

Tenant: TSYS1

Security zone: Host
Send reset for non-SYN session TCP packets: Off
Policy configurable: Yes
Interfaces bound: 0
Interfaces:

Security zone: abc
Send reset for non-SYN session TCP packets: Off
Policy configurable: Yes
Interfaces bound: 0
Interfaces:xe-0/0/1.0

Security zone: def
Send reset for non-SYN session TCP packets: Off
Policy configurable: Yes
Interfaces bound: 1
Interfaces:xe-0/0/3.0
```

show security zones terse

```
user@host> show security zones terse

Zone           Type
my-internal    Security
my-external    Security
dmz            Security
```

show security zones type security

```
user@host> show security zones type security

Security zone: HOST
Send reset for non-SYN session TCP packets: Off
```

```

Policy configurable: Yes
Interfaces bound: all
Interfaces:

Security zone: junos-host
Send reset for non-SYN session TCP packets: Off
Policy configurable: Yes
Interfaces bound: 0
Interfaces:

```

show security zones TRUST

```

user@host> show security zones TRUST
Security zone: TRUST
Send reset for non-SYN session TCP packets: Off
Policy configurable: Yes
Interfaces bound: 0
Interfaces:
xe-7/0/3.0
unidirectional-session-refreshing: Yes

```

Release Information

Command introduced in Junos OS Release 8.5.

tenant option introduced in Junos OS Release 18.3R1.

RELATED DOCUMENTATION

Security Zones Overview

Supported System Services for Host Inbound Traffic

security-zone

show security zones type

IN THIS SECTION

- [Syntax | 913](#)
- [Description | 913](#)
- [Options | 913](#)
- [Required Privilege Level | 914](#)
- [Output Fields | 914](#)
- [Sample Output | 915](#)
- [Sample Output | 915](#)
- [Sample Output | 916](#)
- [Sample Output | 916](#)
- [Release Information | 917](#)

Syntax

```
show security zones type  
    (functional | security)  
<detail | terse>
```

Description

This command displays information about security zones of the specified type.

Options

- `functional`—Display functional zones.

- security—Display security zones.
- detail | terse—(Optional) Display the specified level of output.

Required Privilege Level

view

Output Fields

[Table 85 on page 914](#) lists the output fields for the `show security zones type` command. Output fields are listed in the approximate order in which they appear.

Table 85: show security zones type Output Fields

Field Name	Field Description	Level of Output
Security zone	Zone name.	All levels
Description	Description of the security zone.	none detail
Policy configurable	Whether the policy can be configured or not.	none detail
Interfaces bound	Number of interfaces in the zone.	none detail
Interfaces	List of the interfaces in the zone.	none detail
Zone	Name of the zone.	All levels

Table 85: show security zones type Output Fields (Continued)

Field Name	Field Description	Level of Output
Type	Type of the zone.	All levels

Sample Output

show security zones type functional

```
user@host> show security zones type functional
Functional zone: management
  Description: management zone
  Policy configurable: No
  Interfaces bound: 0
  Interfaces:
```

Sample Output

show security zones type security

```
user@host> show security zones type security
Security zone: trust
  Description: trust zone
  Send reset for non-SYN session TCP packets: Off
  Policy configurable: Yes
  Interfaces bound: 1
  Interfaces:
  ge-0/0/0.0
Security zone: untrust
  Description: untrust zone
  Send reset for non-SYN session TCP packets: Off
  Policy configurable: Yes
```

```

Interfaces bound: 1
Interfaces:
ge-0/0/1.0
Security zone: junos-host
Description: junos-host zone
Send reset for non-SYN session TCP packets: Off
Policy configurable: Yes
Interfaces bound: 0
Interfaces:

```

Sample Output

show security zones type security terse

```

user@host> show security zones type security terse
Zone                Type
trust               Security
untrust             Security
junos-host          Security

```

Sample Output

show security zones type security detail

```

user@host> show security zones type security detail
Security zone: trust
Description: trust zone
Send reset for non-SYN session TCP packets: Off
Policy configurable: Yes
Interfaces bound: 1
Interfaces:
ge-0/0/0.0
Security zone: untrust
Description: untrust zone
Send reset for non-SYN session TCP packets: Off

```

```
Policy configurable: Yes
Interfaces bound: 1
Interfaces:
ge-0/0/1.0
Security zone: junos-host
Description: junos-host zone
Send reset for non-SYN session TCP packets: Off
Policy configurable: Yes
Interfaces bound: 0
Interfaces:
```

Release Information

Command introduced in Junos OS Release 8.5.

The Description output field added in Junos OS Release 12.1.

RELATED DOCUMENTATION

Security Zones Overview

Supported System Services for Host Inbound Traffic

security-zone